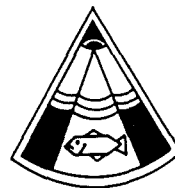


The Proceedings of the
Soviet-Norwegian Symposium
on

The Barents Sea Capelin



Bergen-Norway, 14-17 August 1984

The proceedings of the Soviet-Norwegian symposium on

THE BARENTS SEA CAPELIN

Bergen, 14-19 August 1984

Edited by

H. Gjørøster

CONTENTS

| | | |
|--|------|-----|
| FOREWORD..... | Page | 4 |
| | | |
| SECTION I. Assessment and management..... | | 5 |
| J. Hamre..... | | 5 |
| Assessment and management of Barents Sea capelin | | |
| V.P. Serebryakov, N.G. Ushakov, V.K. Aldonov and A.V. Astaf'eva | | 25 |
| Population fecundity and yearclass abundance of the Barents Sea capelin in 1972-1984 | | |
| S. Tjelmeland..... | | 31 |
| The capelin assessment model - a documentation | | |
| A. Dommasnes and I. Røttingen..... | | 45 |
| Acoustic stock measurements of the Barents Sea capelin 1972-1984. A review | | |
| E.I. Seliverstova and V.N. Shleinik..... | | 109 |
| On methods of biological studies of the Barents Sea capelin | | |
| H. Gjøsæter..... | | 119 |
| Standard sampling procedure for Barents Sea capelin. A description of standard sampling technique and methods applied to improve the representativeness of the samples | | |
| | | |
| SECTION II. Distribution and migration..... | | 135 |
| V.K. Ozhigin and G.I. Luka..... | | 135 |
| Some peculiarities of capelin migrations depending on thermal conditions in the Barents Sea | | |
| V.K. Ozhigin and N.G. Ushakov..... | | 149 |
| The effect of the thermal conditions of the sea and atmospheric circulation on the distribution of the Barents Sea capelin feeding areas | | |
| L.I. Serebrov..... | | 157 |
| On density of distribution and orientation of capelin in schools | | |
| O. Alvheim..... | | 171 |
| Investigations on capelin larvae off northern Norway and in the Barents Sea in 1981-84 | | |
| V.P. Serebryakov, V.K. Aldonov, A.V. Astaf'eva and N.V. Mukhina | | 185 |
| The distribution of capelin larvae in the Norwegian and Barents Seas in April-May 1968-1983 | | |

| | |
|---|-----|
| SECTION III. Biology / Stock structure..... | 193 |
| H. Gjøsaeter..... | 193 |
| Growth of the Barents Sea capelin of the yearclasses 1975-1981 | |
| K. Forberg and S. Tjelmeland..... | 213 |
| Maturity studies of Barents Sea capelin. Variations in length at maturity for female capelin | |
| V.V. Dushchenko..... | 223 |
| Soviet investigations of the intraspecific structure of the Barents Sea capelin | |
| SECTION IV. Workshop reports..... | 231 |
| Report of the acoustics workshop..... | 231 |
| Report of the otolith workshop..... | 233 |

FOREWORD

Nearly all the fish resources in the Barents Sea are shared between the Soviet Union and Norway. Both countries accomplish scientific investigations on the fish stocks in this area, and, to be able to coordinate this work, the two principal institutions involved, the Polar Research Institute of Marine Fisheries and Oceanography (PINRO) in Murmansk and the Institute of Marine Research in Bergen are developing, under the aegis of the Mixed Soviet-Norwegian Fisheries Commission, a programme of close cooperation. As a part of this programme a series of symposia have been planned, dealing with important aspects of the fish stocks in the Barents Sea and their environment.

This volume presents a selection of the contributions presented to the second of these symposia, which was held in Bergen 14-17 August 1984, and which dealt with the Barents Sea capelin stock.

In addition to this version in the English language, the contributions will also appear in a version in the Russian language published by PINRO, Murmansk.

The editor of this version is responsible for some editorial changes in some of the contributions in which it has not been possible to obtain the authors approval. However, dir. Luka of PINRO has approved the edited versions of the contributions presented by the Soviet scientists.

The editor is indebted to miss Karin Pittman for correcting the English text.

Bergen, August 1985

The editor

ASSESSMENT AND MANAGEMENT OF BARENTS SEA CAPELIN

by

Johannes Hamre

Institute of Marine Research
P.O. Box 1870, N-5011 Bergen, Nordnes
Norway

ABSTRACT

The history of the Barents Sea capelin fishery and fishery regulations is reviewed. Basic assessment data and theories are described and discussed in the light of the population dynamics governing the sustainable yield.

1. INTRODUCTION

The large scale capelin fishery in the Barents Sea developed in the latter half of the 1960's, when Norwegian purse seiners started to fish capelin on the spawning grounds during the winter seasons. The increase in fishing effort on capelin had two main reasons, (1) an improved fishing technique due to the introduction of the power block and (2) a large transfer of fishing effort from other fisheries due to the collapse of the herring and mackerel stocks in the Norwegian and North Sea. The rising catches may also to some extent be a result of an increased capelin stock due to the disappearance of the herring.

The present paper reviews the history of the Barents Sea capelin fishery and the regulation measures introduced to conserve the stock. The management of the fishery is described and discussed in the light of the present knowledge on the population dynamics which govern the sustainable yield. In conclusion emphasis is laid on current management problems and areas of current research.

2. THE FISHERY

The Barents Sea capelin stock is exploited almost exclusively by Norway and the USSR. Table 1 summarizes the yearly catches since 1958, which, prior to that year, are very small. The Norwegian purse seine fishery was originally located in coastal waters during winter and early spring and the catches rose to above 200 000 tonnes in 1961. In the next 3 years the catches declined to a very low level, caused by an obvious decline in the abundance of the yearclasses 1958-1960 (Olsen 1968). This temporary disappearance of capelin coincided with the recruitment of two extraordinarily strong herring yearclasses, (1959 and 1960). It is likely that the feeding area of young herring in those years overlapped with the distribution area of juvenile capelin and this could be the reason for the disappearance of the capelin in the early 1960's.

From 1964 onwards, the Norwegian winter catches grew continuously reaching 1.3 mill. tonnes in 1971. There is a temporary decline to 0.55 mill. tonnes in 1975, and then an increase to a record catch of 1.4 mill. tonnes in 1977. In 1978, the Norwegian winter fishery was subjected to a national catch quota regulation. The quota was however not filled and the regulation had probably no effect on the total catch. Since 1979 the Norwegian winter catches have been effectively limited by a bilateral catch quota regulation agreement between Norway and USSR.

A Norwegian summer and autumn fishery for capelin started in 1968 and the catches rose to above 700 000 tonnes in 1977. This fishery's catch was limited to 350 000 tonnes in 1978 by a national catch quota regulation and since 1979 the fishery has been regulated according to the fishery agreement with USSR. Fishing is conducted in the feeding area in offshore waters and is based on the maturing capelin and juveniles.

Prior to 1974, the USSR capelin catches were small and below 50 000 tonnes. A large scale fishery developed in the middle of the 70's, and the annual catch reached a peak of 822 000 tonnes in 1977. The USSR capelin fishery has been regulated according to the fishery agreement with Norway since the winter of 1979.

Table 1. Catch of Barents Sea capelin in the years 1959-83 (1000 t.)

| Year | Norway | | | USSR | Other countries | Sum |
|------|--------|--------|-------|------|-----------------|-------|
| | Winter | Summer | Total | | | |
| 1959 | 80 | | 80 | | | 80 |
| 60 | 90 | | 90 | | | 90 |
| 61 | 230 | | 230 | | | 230 |
| 62 | | | 0 | | | 0 |
| 63 | 30 | | 30 | | | 30 |
| 64 | 20 | | 20 | | | 20 |
| 65 | 217 | | 217 | 7 | | 224 |
| 66 | 380 | | 380 | 9 | | 389 |
| 67 | 403 | | 403 | 6 | | 409 |
| 68 | 483 | 39 | 522 | 15 | | 537 |
| 69 | 436 | 243 | 679 | | | 679 |
| 70 | 969 | 332 | 1301 | 13 | | 1314 |
| 71 | 1303 | 69 | 1372 | 21 | | 1393 |
| 72 | 1208 | 348 | 1556 | 37 | | 1593 |
| 73 | 1084 | 207 | 1291 | 45 | | 1336 |
| 74 | 751 | 236 | 987 | 162 | | 1149 |
| 75 | 549 | 394 | 943 | 431 | 43 | 1417 |
| 76 | 1231 | 718 | 1949 | 596 | | 2545 |
| 77 | 1415 | 701 | 2116 | 822 | 2 | 2940 |
| 78 | 772 | 350 | 1122 | 747 | 25 | 1894 |
| 79 | 542 | 544 | 1086 | 669 | 5 | 1760 |
| 80 | 542 | 434 | 976 | 641 | 9 | 1626 |
| 81 | 716* | 393* | 1109* | 721* | 28 | 1858* |
| 82 | 558* | 601* | 1159* | 596 | | 1755 |
| 83 | 706 | 615 | 1321 | | | |

* Preliminary figures.

3. STOCK MEASUREMENTS

The size and composition of the Barents Sea capelin stock have been assessed by various methods, such as age composition, tagging and acoustic techniques. Larvae production has, moreover, been introduced as index of spawning stock, and data from the international 0-group survey of the Barents Sea is recorded as indices of recruitment.

3.1 Age composition data

Published data on the age composition of spawning capelin covers 1954 and onward. Dommasnes (1984) has reviewed and discussed the available information and concludes that there is a periodic change in the age composition of the spawning stock. In the latter half of the 1950's

the spawning capelin was relatively young, the stock being dominated by the 3-year-old capelin. In this period two-year-old spawners occur whereas the five-year-olds are very scarce. This pattern changes in 1960, when the four-year-olds dominate for the next 5 years. In this period, the two-year-old spawners disappear whereas the contribution of the five-year-old spawners increases. In 1965-67 the capelin have again matured at an early age but after 1967, the four-year-olds and older capelin dominate the spawning component. The changes in the age distribution of capelin are governed by the growth rate, and shows that the maturation of capelin is determined by the size and not by the age. The short lifespan indicates that the fish suffer mass mortality after spawning.

3.2 Assessment based on tagging

The Norwegian Institute of Marine Research tagged maturing capelin in the winters of 1970 to 1975. Internal steel tags were used and recoveries were retained by magnets installed in the meal plants. The analyses of the tagging data are published by Dragesund *et al.* (1973) and by Dommasnes (1977) and indicate that the method is not sufficiently accurate to be used for catch quota regulations. The main sources of error were nonrandom mixing of the tagged fish (within season recoveries only), and high and variable tagging mortality. The Norwegian tagging programme was therefore terminated in 1976.

3.3 Larvae and 0-group surveys

The 0-group capelin are reported in the international larvae surveys since 1965, but the data have not been applied to stock assessment as basis for fishery management.

Larval density studies have been applied as basic data for estimating parent stock (Salvanes, 1984). For the years 1972-76 the larvae abundance estimates are closely correlated to the Norwegian winter catches, but deviate to some extent from the acoustic stock abundance estimates. This is also to be expected since the larvae surveys covered the spawners on the Norwegian coast only.

In order to monitor the distribution area of early hatched capelin larvae in the Barents Sea, a capelin larval survey based on the Gulf III plankton sampler was initiated in 1981. The results from these surveys are presented to this symposium in a paper by Alvheim (1984). The distribution and abundance of capelin larvae have been remarkably constant in the years 1981-84 although the estimated size of the parent stock, based on the acoustic surveys, has varied considerably. The larval abundance estimates as indices of parent stock are, however, considered to have low reliability, and no firm conclusion on the state of the spawning stocks can be drawn from this study.

3.4 Acoustic stock measurements

Acoustic surveys on the Barents Sea capelin have been carried out since 1971. Attempts have been made to survey the stock at various times of the year and, for various reasons, September - October is preferred. The distribution of capelin and measurements of the abundance by areas and ages are obtained. Details of the surveys and the survey results are described and discussed in a paper to this

symposium (Dommasnes and Røttingen 1984).

During the period under study, large changes are observed in the distribution of the capelin and in the size and composition of the stock. In the early 1970's, the capelin had a southwesterly distribution pattern, which expanded north- and eastwards in the course of the first half of the 1970's. The most north- and easterly distribution pattern occurred in 1975 (Figure 1). In the subsequent years the capelin withdrew towards the southwest, reaching the most southwesterly distribution in 1981. A slight northeasterly movement is observed in later years, indicating that a new period of expansion towards north and east has started. These changes in the distribution pattern seem to be linked to changes in the hydrographical condition of the Barents Sea and may become decisive for growth and recruitment conditions, and thus the obtainable yield of capelin in the coming years. These are topics and areas of research which will be discussed in a later session of this symposium (Gjøsaeter and Loeng 1984).

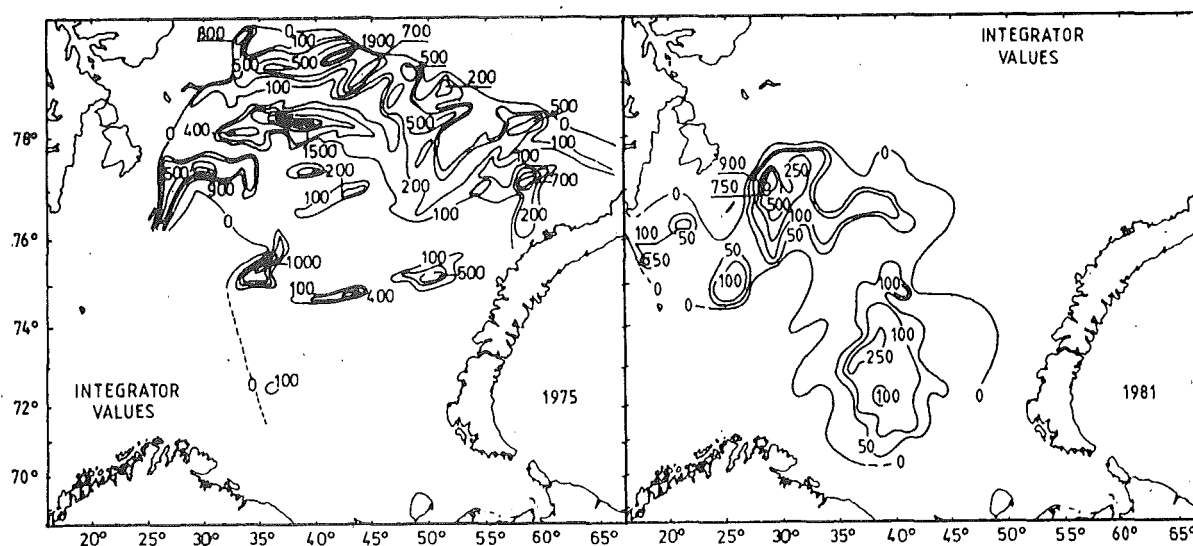


Figure 1. Integrated echo intensity (mm deflection/nautical mile) of capelin in 1975 and 1981.

The acoustic abundance estimates of the catchable stock in weight and average weight by age obtained since 1973 are summarized in Table 2. In 1973-75, when the stock expanded towards the north and east, three very abundant yearclasses (1971-73) were recruited to the catchable stock and the stock biomass increased from 3.5 mill. tonnes to 7.3 mill. tonnes. The growth rate decreased considerably in these years, the average weight of the 3-year-olds, which constitute the main age group of prespawners, went down from 18.6 grams in 1973 to 9.1 grams in 1974. The 2-year-olds were also small, below 6 grams in 1973 and 1974.

The biomass has varied but has, in general, declined. The lowest estimate of 2.6 mill. tonnes was obtained in 1983. The growth increased in 1980 and has later remained at a high level. In general, the table shows a relation between high abundance and low average weight by age and that an increase in the growth rate is followed by a reduction in the life span of the capelin.

This relation between abundance, growth rate, and life span of the capelin supports the basic hypotheses on which the capelin assessment model is built, namely that the growth rate is density dependent, that the maturation of capelin is determined by the size of the fish and that the capelin suffers mass mortality after spawning.

4. FISHERY REGULATIONS

In 1978, the USSR/Norwegian Fisheries Commission agreed to regulate the Barents Sea capelin fishery bilaterally. A closed season regulation from 1 May to 14 August was introduced and the allowable catch of juvenile capelin below 11 cm was limited to 15% in weight. The opening date of the autumn fishery has later been changed to 1 September (1984) and the bycatch limit of undersized fish (below 11 cm) reduced to 10% (1981). In 1981 a minimum mesh size of 16 mm in capelin nets (trawls and purse seiners) was introduced.

A bilateral USSR/Norwegian catch quota regulation of the fishery has been in force since the winter of 1979. Total allowable catch (TAC) is agreed upon for the autumn and winter fishery separately and the table below summarizes the agreed TAC and corresponding catches by seasons (in 1000 tonnes).

| Year | TAC | | | Catch | | |
|------|--------|--------|-------|--------|--------|-------|
| | Winter | Autumn | Total | Winter | Autumn | Total |
| 1979 | 925 | 900 | 1825 | 894 | 866 | 1760 |
| 1980 | 900 | 700 | 1600 | 890 | 736 | 1626 |
| 1981 | 1200 | 700 | 1900 | 1212 | 646 | 1858 |
| 1982 | 800 | 800 | 1600 | 828 | 927 | 1755 |
| 1983 | 1100 | 1200 | 2300 | 1112 | | |
| 1984 | 600 | 800 | 1400 | | | |
| Mean | 920 | 850 | 1770 | 990 | 790 | 1750 |

Prior to the bilateral agreement with USSR, Norway regulated its capelin fishery by catch quotas in the winters of 1974 (7.2 mill. hl) and 1978 (11.5 mill. hl) and in the autumn of 1978 (3.5 mill. hl). Various closed areas were introduced to protect spawners on main spawning grounds, and juveniles on main feeding grounds.

5. THE ASSESSMENTS OF STOCK AND YIELD

5.1 Fishery management 1974-78

Based on knowledge and experience derived from various research activities, it has been decided to use the acoustic stock measurements in autumn as basis for the management of the capelin fishery.

Table 2. Acoustic estimation of the capelin stock (million tonnes) by age in autumn 1973-82. Average weight (grammes) for each age group are given in parantheses.

| Year | Age | | | | Sum 2 years and older |
|------|--------------|---------------|----------------|------------------|-----------------------------|
| | 2 | 3 | 4 | 5 | |
| 1973 | 2.3 (5.6) | 0.8 (18.6) | 0.4 (23.3) | 0.006 - | 3.5 |
| 1974 | 3.1 (5.6) | 1.6 (9.1) | 0.07 (21.2) | 0.002 - | 4.8 |
| 1975 | 2.5 (6.8) | 3.3 (10.4) | 1.5 (16.0) | 0.01 (19.0) | 7.3 |
| 1976 | 2.0 (8.2) | 2.1 (12.4) | 1.4 (16.4) | 0.3 (18.2) | 5.8 |
| 1977 | 1.5 (8.1) | 1.7 (16.8) | 0.9 (20.9) | 0.2 (23.0) | 4.2 |
| 1978 | 2.5 (6.7) | 1.7 (16.5) | 0.3 (20.7) | 0.02 (23.1) | 4.5 |
| 1979 | 2.5 (7.4) | 1.5 (13.5) | 0.1 (21.1) | 0.0005 (28.7) | 4.1 |
| 1980 | 1.9 (9.4) | 2.8 (18.2) | 0.8 (24.7) | 0.006 - | 5.5 |
| 1981 | 1.8 (9.4) | 0.8 (17.0) | 0.3 (23.3) | 0.008 (28.7) | 3.0 |
| 1982 | 2.8 (9.0) | 1.3 (20.9) | 0.05 (24.9) | | 4.2 |
| 1983 | 1.9 (9.5) | 0.7 (18.9) | 0.01 (19.4) | | 2.6 |

When Norway limited its catch of capelin in the winter of 1974 to 7.2 mill. hl, this was based on the results of the acoustic stock measurements in 1972 and 1973 (Dommasnes and Røttingen (1984), Tables 1 and 2). Comparing the two estimates it is seen that the contribution of 3-year-olds and older capelin in 1973 declined to less than half of the 1972 measurements (12.0 mill. hl in 1973, 26.6 mill. hl in 1972). These age groups were assumed to constitute the bulk of spawners in the next winter and, taking into account that 12 mill. hl capelin had been caught in previous years (Table 1), it was felt that a free fishery in 1974 could endanger recruitment. No attempt was, however, made to evaluate consequences of an alternative management policy due to lack of basic knowledge (stock - recruitment relationship, natural mortality, consistency of the acoustic stock measurements). The catch quota of 7.2 mill. hl for the winter fishery in 1974, was thus introduced as an act of discretion.

The winter fishery in 1974 turned out to be rather poor and thus in accordance with expectation. This was, in fact, the first time that a large change in stock abundance, measured by the new acoustic technique, was tested by the output of the fishery and the result yielded conditional confidence in the method. The catch quota was not filled before the first week of April, and the regulation had probably little effect on the attainable catch.

Table 3. Acoustic abundance estimate autumn 1981.

| Total length (cm) | Age | | | | | Total number $\times 10^{-7}$ | Biomass tonnes $\times 10^{-3}$ | Biomass (cumulative) |
|----------------------|-------|-------|------|------|----|-------------------------------|---------------------------------|----------------------|
| | 1 | 2 | 3 | 4 | 5+ | | | |
| 6.5- 6.9 | 1805 | | | | | 1805 | 16.2 | |
| 7.0- 7.4 | 3180 | | | | | 3180 | 31.8 | |
| 7.5- 7.9 | 5814 | | | | | 5814 | 75.7 | |
| 8.0- 8.4 | 6387 | | | | | 6387 | 115.2 | |
| 8.5- 8.9 | 5723 | 8 | | | | 5731 | 120.6 | |
| 9.0- 9.4 | 5188 | 34 | | | | 5222 | 135.0 | |
| 9.5- 9.9 | 4142 | 132 | | | | 4274 | 129.3 | |
| 10.0-10.4 | 2643 | 256 | | | | 2899 | 108.2 | |
| 10.5-10.9 | 2162 | 470 | | | | 2632 | 113.6 | |
| 11.0-11.4 | 786 | 896 | | | | 1682 | 88.5 | |
| 11.5-11.9 | 299 | 1743 | 5 | | | 2047 | 127.4 | |
| 12.0-12.4 | 162 | 3069 | 19 | | | 3250 | 233.7 | |
| 12.5-12.9 | 125 | 4195 | 59 | | | 4379 | 363.5 | |
| 13.0-13.4 | 50 | 3276 | 229 | 4 | | 3559 | 342.4 | |
| 13.5-13.9 | 20 | 2347 | 466 | 1 | | 2834 | 315.1 | 1864.8 |
| 14.0-14.4 | 7 | 1532 | 641 | 2 | | 2182 | 276.5 | 1549.7 |
| 14.5-14.9 | | 676 | 701 | 20 | | 1397 | 201.4 | 1273.2 |
| 15.0-15.4 | | 355 | 705 | 140 | 4 | 1204 | 197.4 | 1071.8 |
| 15.5-15.9 | | 164 | 697 | 199 | | 1060 | 189.8 | 874.4 |
| 16.0-16.4 | | 94 | 468 | 197 | 2 | 761 | 155.4 | 684.6 |
| 16.5-16.9 | | 79 | 344 | 259 | | 682 | 155.6 | 529.2 |
| 17.0-17.4 | | 67 | 157 | 172 | 4 | 400 | 106.7 | 373.6 |
| 17.5-17.9 | | 52 | 162 | 182 | 6 | 402 | 120.0 | 266.9 |
| 18.0-18.4 | | 38 | 66 | 129 | | 233 | 77.7 | 146.9 |
| 18.5-18.9 | | 17 | 51 | 49 | 10 | 127 | 46.3 | 69.2 |
| 19.0-19.4 | | | 15 | 2 | | 17 | 7.8 | 22.9 |
| 19.5-19.9 | | | 5 | 19 | | 24 | 11.5 | 15.1 |
| 20.0-20.4 | | | 1 | 3 | | 4 | 2.3 | 3.6 |
| 20.5-20.9 | | | 2 | | | 2 | 1.3 | 1.3 |
| No. $\times 10^{-7}$ | 38493 | 19500 | 4793 | 1378 | 26 | 64190 | | |
| No. >13.4 | 27 | 5421 | 4481 | 1374 | 26 | 11329 | | |
| Biomass | | | | | | | 3865.6 | |

In autumn of 1974, a new important change in the composition of the stock occurred (Dommasnes and Røttingen (1984), Table 3). The same age groups as those which had matured and spawned the previous years (3 and older) appeared to be very numerous, but the mean length of the

fish had drastically declined (9.1 cm against 15.6 cm in 1973 for 3-year-olds). According to the maturity scale in use (Monstad 1971) these small sized fish were not expected to mature and spawn the next winter. It was therefore concluded that the maturing stock in the winter 1975 might become even smaller than in the year before. The risk of overfishing the spawners in the winter of 1975 was thus even larger than in 1974, but due to the large stock of juveniles it was decided not to limit the Norwegian 1975 winter catch. It was noted that the slow growth of the 3-year-old capelin could be density-dependent and, if so, an increased exploitation could be preferable in order to reduce the population density (Anon 1975).

Table 4. Acoustic abundance estimate, autumn 1975.

| Total length (cm) | Age | | | | | Total number x 10 ⁻⁷ | Biomass tonnes x 10 ⁻³ | Biomass (cumulative) |
|------------------------|-------|-------|-------|------|----|---------------------------------|-----------------------------------|----------------------|
| | 1 | 2 | 3 | 4 | 5+ | | | |
| 5.5- 5.9 | 25 | | | | | 25 | 0.1 | |
| 6.0- 6.4 | 7 | | | | | 7 | 0.0 | |
| 6.5- 6.9 | 7 | | | | | 7 | 0.0 | |
| 7.0- 7.4 | 19 | | | | | 19 | 0.2 | |
| 7.5- 7.9 | 158 | | | | | 158 | 1.9 | |
| 8.0- 8.4 | 460 | 45 | | | | 505 | 8.9 | |
| 8.5- 8.9 | 1848 | 21 | | | | 1869 | 38.6 | |
| 9.0- 9.4 | 4049 | 285 | | | | 4334 | 114.0 | |
| 9.5- 9.9 | 4483 | 806 | | | | 5288 | 166.8 | |
| 10.0-10.4 | 4975 | 1305 | | | | 6278 | 242.9 | |
| 10.5-10.9 | 2549 | 3439 | 33 | | | 6022 | 265.2 | |
| 11.0-11.4 | 1008 | 5254 | 1041 | 41 | | 7347 | 358.4 | |
| 11.5-11.9 | 320 | 8223 | 3084 | 88 | 12 | 11727 | 692.2 | |
| 12.0-12.4 | 82 | 6435 | 4085 | 292 | | 10909 | 773.0 | |
| 12.5-12.9 | | 4455 | 5402 | 503 | 35 | 10388 | 880.8 | |
| 13.0-13.4 | | 2696 | 4397 | 855 | | 7956 | 788.9 | |
| 13.5-13.9 | | 1655 | 3553 | 742 | | 5943 | 671.6 | 3636.5 |
| 14.0-14.4 | | 681 | 2724 | 984 | | 4393 | 562.5 | 2964.9 |
| 14.5-14.9 | | 241 | 1920 | 906 | | 3063 | 456.0 | 2402.4 |
| 15.0-15.4 | | 269 | 1564 | 583 | | 2412 | 389.1 | 1946.4 |
| 15.5-15.9 | | 150 | 902 | 1069 | 18 | 2145 | 400.1 | 1557.3 |
| 16.0-16.4 | | 108 | 681 | 841 | | 1627 | 343.8 | 1157.2 |
| 16.5-16.9 | | | 530 | 636 | | 1164 | 281.9 | 813.4 |
| 17.0-17.4 | | | 224 | 569 | 32 | 826 | 232.3 | 531.5 |
| 17.5-17.9 | | | 148 | 464 | | 610 | 183.7 | 299.2 |
| 18.0-18.4 | | | 111 | 157 | | 265 | 91.7 | 115.5 |
| 18.5-18.9 | | | 7 | 59 | | 66 | 23.8 | 23.8 |
| No. x 10 ⁻⁷ | 19990 | 36068 | 30406 | 8789 | 97 | 95353 | | |
| No. > 13.4 | | 3104 | 12364 | 7010 | 50 | 22514 | | |
| Biomass | | | | | | | 7995.5 | |

The Norwegian winter fishery in 1975 yielded less than 6 mill. hl, the availability of capelin being obviously lower than in 1974. These events strengthened the confidence in the acoustic method and demon-

strated that the maturation of capelin depends on size rather than age. The observations further indicated that the growth was density-dependent, and the dynamics of such a population will, to a very large extent, be determined by the individual's growth.

In 1976 and 1977, 3 rich yearclasses (1971-73) matured and spawned in 2 years, resulting in correspondingly rich catches. The consistency of the bio-acoustic stock estimates and their conformity with the catches in these years further strengthened the reliability of the acoustic method. In the autumn of 1977 the stock had declined to 4.2 million tonnes (Table 2), and due to this Norway regulated its capelin fishery by a catch quota of 15 million hl in 1978.

5.2 The TAC for 1979

When the rich yearclasses of 1971-73 had passed the fishery in 1978, a regulation of the catch was considered as a matter of urgency. The USSR/Norwegian Fishery Commission therefore requested scientists from the two countries to evaluate the state of stock and submit proposals for necessary joint management actions. Two meetings of scientists were held in 1978 and the following important agreements were made: (a) A TAC-assessment of capelin should be based on acoustic stock measurements carried out jointly in the autumn; (b) the assessment period should cover the autumn and subsequent winter fishery and (c) the TAC-assessment should aim at a minimum stock of spawners of 500 000 tonnes (Anon 1978, a and b).

The 500 000 tonnes minimum spawning stock was judged according to a rough evaluation of stock-recruitment data from previous years. The agreements provided a basis for calculating TAC for the 1979 winter fishery, and the principals of this first TAC-calculation for capelin may be summarized in the following paragraphs (Anon 1978, a and b).

The acoustic stock estimate in numbers by yearclass in successive years was used to calculate the total mortality (Z) and, adjusted by the catch, the natural mortality (M) by age. The estimated M-values from 2- to 3-year-old fish were then taken as the natural mortality of non-spawning capelin. The following values were obtained.

1974-75, $M = 0.77$
1975-76, $M = 0.78$
1976-77, $M = 0.65$

The estimates refer to 1 year periods starting with 1 October. On the basis of results of the USSR investigations on the seasonal feeding patterns of cod (regarded as the main capelin eater), the M values were divided in two periods, 1 October - 1 May and 1 May - 1 October, in proportion 75% and 25% respectively.

The fishing pattern (F-values) of the previous years were then calculated on the basis of the catch by season using the VPA-method.

The 1978 stock in number by age, derived from the acoustic survey in September, was taken as input data of the initial catchable stock. Applying mean values of F and M from previous years, the total allowable catch which would maintain a spring spawning stock of 500 000 tonnes was then calculated, assuming that the catch would consist

of prespawners only, and that the spawners would be dominated by the 4-year-olds and older fish. The calculations were made on the basis of number by age, and the spawning biomass was converted to weight by using observed mean weight of spawners in March.

Based on this calculation of TAC, the USSR/Norwegian Fishery Commission agreed to limit the total winter catch in 1979 to 925 000 tonnes.

The 1978 acoustic stock estimate of 2-year-old capelin was further applied to calculate a preliminary TAC for the 1979-80 period. This was done by projecting the measured stock of 2-year-old capelin one year ahead, using average M- and F-values and weight by age calculated for previous years. This prognosed stock of 3-year-old capelin in the autumn 1979 was taken as the main component of the 1980 winter spawners and used as initial stock in a similar TAC-calculation for the period one year ahead (1979-80). This TAC was calculated to 1.8 mill. tonnes. It was, however, stressed that this TAC should be considered with caution and had to be reassessed and adjusted if necessary when new stock data from the 1979 autumn survey become available (Anon 1978, b). Based on this advise, the Commission agreed to limit the total autumn catch in 1979 to 900 000 tonnes, allocating 900 000 tonnes as preliminary TAC for the winter fishery in 1980.

5.3 The TAC for 1980

The same procedure of TAC-calculation has in principal been followed in the subsequent years. The group of scientists, who meet (in Hammerfest) immediately after the joint acoustic autumn survey, reassesses the prognosed stock and preliminary TAC-estimate made the previous year. The stock abundance measurements are reduced by the remaining catch quota per 1 October, and the natural mortality and an initial stock of spawners per 1 January is reassessed. From this stock the final winter TAC is derived. The calculated stock of non-spawners is then projected ahead to the opening for the autumn fishery and used as initial stock for a preliminary TAC-estimate of the next regulation period. A proportion of the latter TAC is recommended as TAC for the autumn fishery.

The simple stock model used for TAC-calculations in 1978 had distinct shortcomings. The lack of an adequate technique to separate spawners from non-spawners in the acoustic stock estimate was an obvious source of error for the calculation of spawning stock and mortality as well. It was realized that the maturity scale in use was inapplicable for this purpose and a new investigation was initiated to construct a scale which could predict the spawning time. The results obtained are published by Forberg (1982 and 1983) and in a paper to this symposium (Forberg and Tjelmeland 1984).

As mentioned previously (section 3.1), the maturation of capelin appears to be more linked to the size of capelin than to the age and, at the joint USSR/Norwegian capelin meeting in 1979, it was suggested to separate potential spawners from non-spawners by the length of fish. A new parameter, the maturation length was introduced, defined as the length of capelin (in September) at which all fish exceeding that length are supposed to mature and spawn the next winter. The capelin smaller than that length were considered juveniles (Table 3). The maturation was thus assumed to be independent of age of capelin and a selected maturation length would therefore determine the age

composition of the maturing component stock estimate. By comparing this age composition to that of the subsequent winter spawners using data from the catches in March, the maturation length could be determined. By this method the 1979 Hammerfest meeting calculated the maturation length for the years 1974 to 1979, and found that the length had varied between 15.2 cm and 13.7 cm (Anon 1979). The latter was observed in recent years. The 1979 meeting therefore agreed to apply a maturation length of 13.5 cm for the 1980 management advices. The 1979 acoustic stock estimate was thus divided into a maturing stock component containing all capelin exceeding 13.5 cm and a juvenile stock consisting of the smaller fish. A spawning stock prognosis by the 1 January 1980 was calculated, and a catch of 800 000 tonnes in the winter of 1980 was found to reduce that stock to 507 000 tonnes, whereas the preliminary recommended TAC of 900 000 tonnes winter catch would reduce the spawning stock to 425 000 tonnes. Pointing to the various uncertainties in the estimate, the scientists recommended 900 000 tonnes as final TAC for the winter fishery in 1980. This recommendation was approved by the USSR/Norwegian Fishery Commission.

The estimated stock of juveniles (capelin smaller than 13.5 cm) was projected ahead and used as input data for the TAC calculation of the subsequent regulation period. Based on this stock prognosis a TAC of 1.6 mill. tonnes was calculated for the autumn catch 1980 plus the winter catch in 1981. It was however recommended that not more than 700 000 tonnes should be allocated to the autumn fishery in 1980, and that the remaining 900 000 tonnes should be set as preliminary TAC of the winter 1981. This recommendation was adopted by the Fishery Commission (See section 7).

5.4 The TAC for 1981

The results of the acoustic capelin survey in 1980 were in good agreement with the stock prognosis made in 1979 with respect to number at age, but due to extraordinarily good individual growth in 1980 the biomass of maturing capelin was far above expectations. The mean length at age had increased substantially (Dommasnes and Røttingen 1984), and, assuming a length dependent maturation scale, a larger proportion of the stock was expected to mature and spawn the next winter. It was calculated that by applying a maturation length of 14.5 cm in the 1980 stock measurement, a catch of 1.2 mill. tonnes for the winter 1981 would reduce the biomass of spawners slightly below 800 000 tonnes, and the Norwegian scientists of the 1980 Hammerfest meeting were of the opinion that the preliminary TAC for the winter 1981 (900 000 tonnes) should be increased to 1.2 mill. tonnes. The USSR scientists were however of the opinion that the new stock situation should be considered with caution and recommended 1.0 mill. tonnes. The Fishery Commission accepted the 1.2 mill. tonnes TAC for the winter fishery in 1981. The 1980 Hammerfest meeting considered the prospects for the 1981-82 catch to be far below that of the current regulation period due to recruitment of a weaker yearclass (1978) and higher expected mortality of post spawners. By projecting the juvenile stock (capelin smaller than 14.5 cm) one year ahead and using this as expected catchable stock in the autumn 1981, the meeting assessed a preliminary TAC of 1.3 to 1.5 mill. tonnes for the 1981-82 regulation period depending on the expected maturation length in 1981. Based on this study the meeting recommended a TAC of 700 000 tonnes for the autumn fishery in 1981. This recommendation was approved (Anon 1980).

5.5 The TAC for 1982

The acoustic stock measurements obtained in the autumn 1981 were in good agreement with the projected stock based on the previous year abundance measurements of juveniles. The 1981 Hammerfest meeting agreed to assess the TAC, according to the same procedure as last year. Details of the calculated TAC's appear in the table below (l_s = maturation length):

| TAC winter 1982 | 1982 Spawners | | TAC autumn 1982 | TAC winter 1983 | 1983 Spawners | |
|-----------------------|------------------|--------------|-----------------------|-----------------------|------------------|--------------|
| | $l_s = 14.0$ | $l_s = 14.5$ | | | $l_s = 14.0$ | $l_s = 14.5$ |
| 600 | 584 | 381 | 500 | 500 | 948 | 815 |
| 700 | 493 | 291 | 600 | 600 | 810 | 679 |
| 800 | 401 | 201 | 700 | 700 | 671 | 544 |
| 900 | 312 | 113 | 800 | 800 | 533 | 411 |
| 1000 | 223 | 32 | 900 | 900 | 397 | 279 |
| | | | 1000 | 1000 | 262 | 150 |

Based on this study, the meeting recommended that 800 000 tonnes be fished in the winter 1982. This was a somewhat larger catch than should be permitted according to the agreed minimum spawning stock, (500 000 tonnes), but judging from estimated mortality of 1980-81, which was found to be extraordinarily high, the meeting considered the 1981 stock measurements to be underestimated. This recommended TAC was approved by the Fishery Commission, whereas a recommended 800 000 tonnes TAC for the autumn fishery in 1982 was increased by the Commission to 900 000 tonnes (Anon 1981).

5.6 The TAC for 1983

The acoustic stock survey in the autumn 1982 gave abundance estimates which were unreasonably high, especially for the 1980 yearclass, which was previously assumed to be below average. In the 1982 survey this yearclass was strong and the older yearclasses were also measured above the expectation. This observation together with the fact that the intercalibration data of the acoustic instruments onboard the participating research vessels did not tally (Dommasnes and Røttingen 1984), gave rise to doubts about the reliability of the measurements. But, lacking definite observations which could be used to alter the stock measurements, the 1982 Hammerfest meeting accepted the survey results as basic data for the next year TAC assessment. This resulted in a recommended winter catch of 1.1 mill. tonnes and an autumn catch of 1.2 mill. tonnes for the year 1983. (Anon 1982).

5.7 The TAC for 1984

When the results of the 1983 acoustic stock survey became available it was obvious that the 1982 stock had been overestimated, particularly the stock of juveniles (1980 yearclass). The contribution of 2 and 3 years old capelin, which according to the 1982 stock prognosis should

have been at a level of 5 mill. tonnes in 1983, were reduced to 2.5 mill. tonnes. Older capelin were missing, but this was in accordance with the expectation. The capelin was now considered to be seriously threatened by overfishing, taking into account the large autumn TAC in 1983. The 1983 Hammerfest meeting therefore recommended cutting the 1983 autumn TAC by 20% if possible. No definite TAC-recommendation for the winter fishery in 1984 was made, but an allowable catch of 500 000 tonnes was indicated. This catch limit was later recommended by the ACFM. For the 1984 autumn fishery, a catch of 600 000 tonnes was recommended which may imply a winter catch in 1985 somewhat above 800 000 tonnes (Anon 1983)

No reduction of the 1983 autumn TAC was agreed upon and the USSR/Norwegian Fishery Commission suggested that their governments set the TAC of 1984 to 600 000 tonnes and 800 000 tonnes for the winter and autumn fishery respectively. It may therefore be concluded that the present management strategy of capelin approved by the two countries last year represents an increased exploitation policy. This gives reason for concern about the future development of the capelin fishery in the Barents Sea.

6. SUSTAINABLE YIELD ESTIMATES

The guideline for a regulation of a fishery is the expected effects on the sustainable yield. The effects of the minimum landing size of capelin and the closed season regulation have not been assessed in detail. There is no doubt that such measures are of importance in optimizing the sustainable yield, particularly the closed season regulation. The capelin has a short growth period and the yield can only be optimized if the fishing strategy is adjusted so that the fishing starts at the end of the growth period.

The effects of the catch quota regulation have, on the other hand, been assessed by modelling the exploitation of the capelin stock to determine the sustainable yield. As to the details of the mathematical model used, reference is made to the documentation of the model presented in a paper to this symposium. (Tjelmeland 1984). The model is, in principle, a Beverton and Holt stock model in which the natural mortality is implemented in the form of two independent parameters, one proportional to the stock size, and the other as the fraction of the stock which has spawned. The model assumes that the capelin mature according to length, as was the basic hypothesis in the TAC-calculation. In the long term yield estimate it is further supposed that the maturation length is constant and does not vary with year. This additional hypothesis allows another method of estimating this length, provided that the natural mortality of juveniles is also constant and that all the postspawners die.

There are two features of the effects of a length-dependent maturity scale on the acoustic estimate (see Tables 3 and 4). The maturation length determines the age composition of the potential spawners. This was previously applied to estimate the maturation length by comparison with the age composition data derived from the catches in March. The maturation length will, however, also determine the abundance estimates of juveniles at age and thus the mortality estimates derived from comparative abundance estimates of yearclasses by year, provided that the spawners die. An overall maturation length and corresponding M-value for juveniles can thus be found by selecting those which best fit the observations over a period of years. This has been done for

Assessment and management of the Barents sea capelin

the period 1973-1980, which resulted in a overall spawning length of 13.8 cm and a $M=0.68$ (0.057 per month). This estimate is close to the smallest maturation length obtained by comparing age composition of expected spawners with the March catches. This is consistent with the view that the use of the March catches, as representative for the spawners, overestimates the maturation length according to the strength of later spawners (summer spawners) because this component may often consist of younger fish (Prokhorov 1965). The overall estimates of maturation length and M were therefore considered the most realistic estimates for use in assessment of long term yield (Hamre and Tjelmeland 1982).

Due to mass mortality of postspawners, the stock-recruitment relationship of capelin is a matter of great importance in determining the MSY. This relationship has been studied on the basis of estimated spawning indices of the yearclasses 1974 to 1978 and corresponding indices of recruitment measured as the abundance of the yearclasses of two-year-olds. The spawning stock indices are derived from the acoustic stock measurements separating mature and immature components by an overall maturation length of 13.8 cm. The overall estimate, $M=0.68$, is applied both for the juveniles and for the maturing part of the population. The calculated indices of stock and recruitment by yearclasses are plotted in Figure 2. These data were fitted to a Beverton and Holt recruitment function and the relevant parameters calculated. A function relating the recruitment to stock size was thus obtained, and implemented in the yield model.

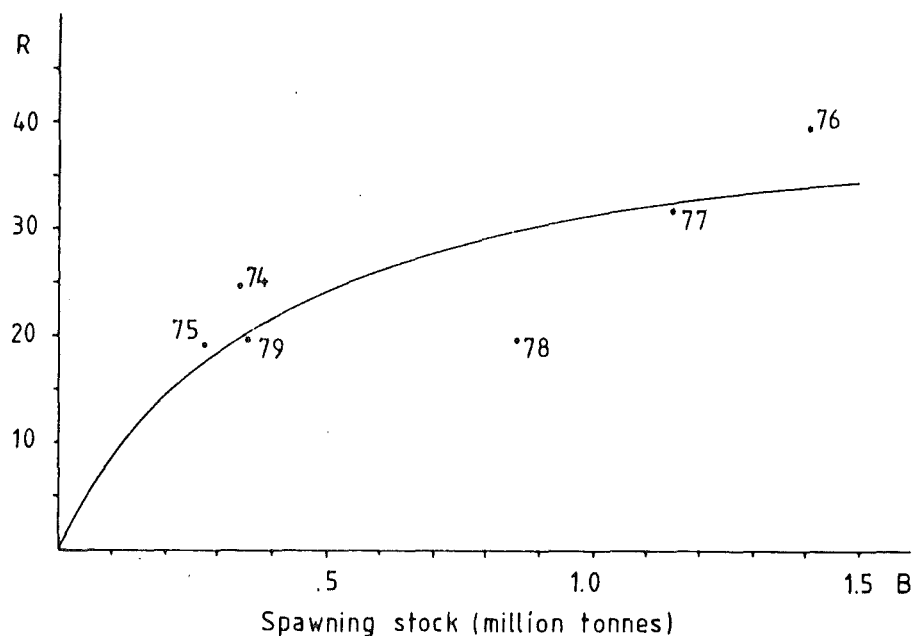


Figure 2. Stock-recruitment relationship of Barents Sea capelin. The solid line shows the function $R = \frac{44.5 \cdot B}{0.43 + B}$, where R = recruited individuals $\times 10^{10}$ and B = spawning stock biomass in mill. tonnes.

In addition to recruitment, the growth rate of capelin is of particular importance to the sustained yield because the length dependent maturity makes the mortality of spawners growth dependent.

The effects on the obtainable yield of capelin by a variable growth pattern is thus rather complex and a further gain in knowledge of these processes demands skilled field observation and modelling of the population dynamics. Another feature of growth characteristics of great importance to fishery management is knowledge of the relationship of growth to external factors, which may help to predict a possible change in the future growth pattern. These are areas of current research which will be discussed in a later session of this symposium (Gjøvsæter 1984, Gjøvsæter and Loeng 1984).

As to details of the growth function used in the capelin model, reference is made to the model documentation (Tjelmeland 1984). Augmented by a modelled fishing pattern, the model calculates yield and corresponding spawning stock as a function of the total fishing mortality F . Running the model until the equilibrium stock and catch are reached, the relevant data to construct the yield curve are obtained. Yield curves for two specific fishing patterns are shown in Figure 3. The figure also includes curves showing biomass output of M (biomass of capelin suffering natural death, excluding death of postspawners).

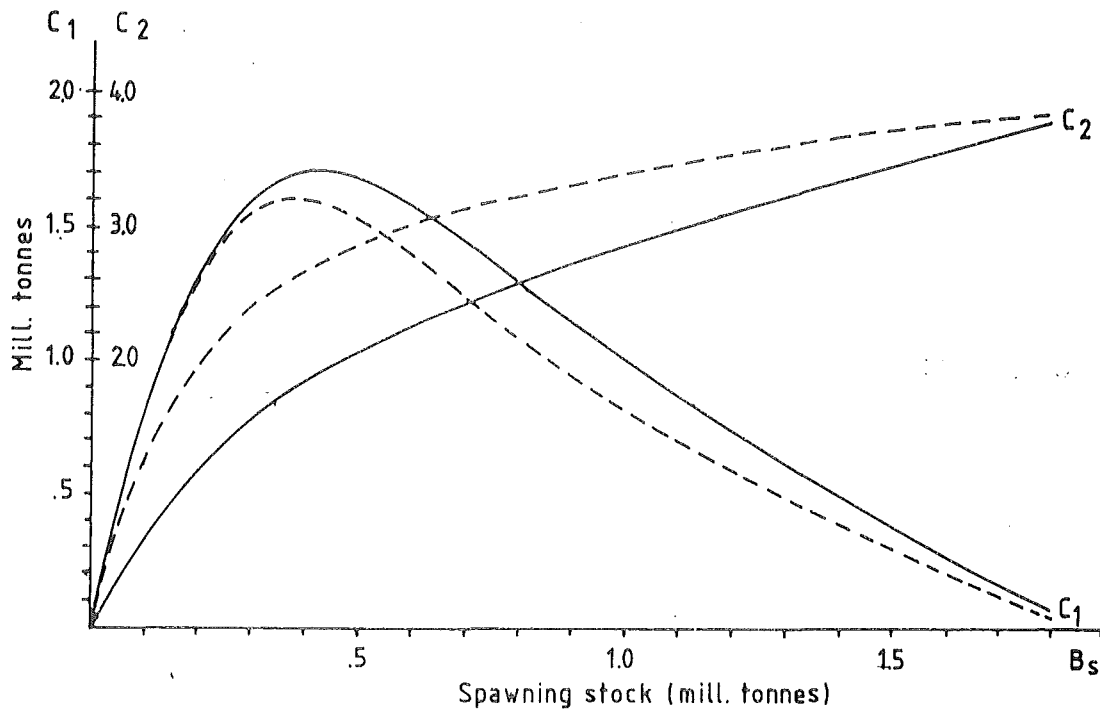


Figure 3. Sustainable yield (C_1) and M -output biomass (C_2) for Barents sea capelin at different levels of spawning stock (B_s). Broken lines apply to winter fishing only, solid lines autumn fishing only.

Figure 3 illustrates the estimates of sustained yield (C_1) and biomass output of M (C_2) by season as a function of the spawning stock. The two extreme cases are chosen for this illustration: (a) autumn fishery only (solid line) and (b) winter fishery only (broken line).

The yield curve (C_1) in the figure shows that the MSY is obtained by

fishing the capelin in autumn and by an exploitation corresponding to a steady state of spawning stock of 450 000 tonnes. With similar growth and recruitment relationships as for the 6 yearclasses under study (Figure 2), this MSY amounts to 1.7 mill. tonnes. The MSY is reduced to 1.6 mill. tonnes if the whole catch is taken during the winter season (10% reduction), and is obtained by a constant spawning stock of 400 000 tonnes. It is noted that with a range of 300 000 to 500 000 tonnes of spawning stocks, the sustained obtainable yield is close to maximum for the two fishing patterns. This may justify the adopted TAC strategy for capelin which aim at a steady state of spawning stock of 500 000 tonnes.

The capelin is an important food resource for other exploited stocks in the Barents Sea. In a management context, it may therefore be of interest to know the effects of various fishing strategies on the capelin stock as a food supply to other animals. As illustrated by the M-output curves (C) it is seen that by managing an exclusive autumn fishery with a MSY strategy, some 2.0 mill. tonnes of capelin remains as food for other stocks, excluding the biomass of postspawners (450 000 tonnes). However, the importance of the stock as foodfish increases to some 2.5 mill. tonnes of capelin when the catch is taken during the winter only. One may therefore conclude that an increased autumn TAC of capelin at the cost of the winter catch will increase the obtainable yield slightly, but this strategy will substantially reduce the stock as food resource for other animals.

7. ALLOCATION OF TAC ON SEASONS

The allocation key of the yearly TAC on seasons is determined when the next year's allowable autumn catch is negotiated. The scientific advice on the autumn TAC is derived from a spawning stock prognosis one and a half years in advance and is subject to errors which may be corrected after the next year's survey. The assessment is therefore regarded as preliminary, and only used as a guideline for assessing the autumn TAC. As a safe-guarding measure, the 1980 autumn TAC was recommended to be set at a lower level than the subsequent winter catch. In later years, however, the practice has been to assess the autumn TAC as the half of the preliminary assessed TAC for the next regulation period. This allocation key is acceptable if the stock prognosis for the next year tallies, but the shortcomings arise when the autumn TAC is derived from a too optimistic stock prognosis, as happened in 1982. The 1983 USSR/Norwegian meeting of scientists in Hammerfest had a profound discussion of this problem, and proposed to return to the 1980 agreement to set autumn TAC below that of the subsequent winter. This would lower the risk of overfishing the young age-groups in years when the maturing stock is relatively small and reduce the negative effects of a autumn TAC derived from a too optimistic abundance estimate (Anon 1983). In spite of this advice, the USSR/Norwegian Fishery Commission increased the recommended autumn TAC for 1984 substantially, probably to compensate for the poor 1984 winter catch. This increased TAC will, however, reduce the next year's winter TAC correspondingly, resulting in a similar need for catch compensation in 1985. This may develop into a vicious circle, in which the autumn catches are increased at the expense of the winter catches. It should be noted that this sequence of events were experienced during the collapse of the Icelandic capelin stock in the early 1980's. The recent developments in the exploitation pattern of the Barents Sea capelin are therefore regarded with concern.

8. AREAS OF CURRENT RESEARCH

The development of the bio-acoustic stock abundance measurement techniques have had highest priority in the research activity on capelin since the early 1970's. Research on population behaviour, general biology and population dynamics has, however, developed gradually as relevant data and observation became available, mostly through the acoustic surveys. Apart from the acoustic surveys, the most important areas of current research, with direct reference to fishery management problems are:

1. Research on multispecies relationship. Research on overlap in distribution areas of herring and capelin in the Barents Sea. Grazing and food competition research. Predator - prey relationships to other stocks (cod, haddock, main mammal stocks).
2. Maturity and growth studies. Investigation of the maturity scale which may predict spawning time. Research on the inter-relationship between growth and maturity. Research on growth characteristics as basis for growth prognosis. Research on growth patterns (otolith studies) as basis for unit stock analysis.
3. Investigation of stock structure. Assessment of late spawners (summer spawners). Investigations in their biology and their relationship to the winter spawners.
4. Population modelling. Updating of parameters. Modelling the population dynamics of capelin by sexes. Modelling the multispecies relationship.

Research activities related to these topics should be given high priority in the current research program on the Barents Sea capelin stock.

9. REFERENCES

- Alvheim, O. Investigations on capelin larvae off northern Norway and in the Barents Sea in 1981-1984. Contribution to the joint Soviet/Norwegian symposium on the Barents Sea capelin, Bergen, August 1984. 13 pp. (Included in this volume).
- Anon 1975. Ressursoversikt for 1975. Fisken Hav., 1975 (særnummer) 1, 129 pp. (In Norwegian).
- Anon 1978(a). Report of the meeting of scientists from PINRO and the Norwegian Institute of Marine Research, Bergen. April 1978, 26 pp. [Mimeo.]
- Anon 1978(b). Report of the 2. USSR/Norwegian Working Group Meeting on Barents Sea Capelin. Hammerfest October 1978, 19 pp. [Mimeo.]
- Anon 1979. Report of the 3. USSR/Norwegian Working Group Meeting on Barents Sea Capelin. Hammerfest October 1979, 23 pp. [Mimeo.]
- Anon 1980. Report of the 4. USSR/Norwegian Working Group Meeting on Barents Sea Capelin. Hammerfest October 1980, 21 pp. [Mimeo.]

Assessment and management of the Barents sea capelin

- Anon 1981. Report of the 5. USSR/Norwegian Working Group Meeting on Barents Sea Capelin. Hammerfest October 1981, 28 pp. [Mimeo.]
- Anon 1982. Report of the 6. USSR/Norwegian Working Group Meeting on Barents Sea Capelin. Hammerfest October 1982, 22 pp. [Mimeo.]
- Anon 1983. Report of the 7. USSR/Norwegian Working Group Meeting on Barents Sea Capelin. Hammerfest October 1983, 16 pp. [Mimeo.]
- Dommasnes, A. 1977. Survival of tagged Barents Sea capelin (Mallotus villosus, Müller) and estimates of the 1973, 1974 and 1975 spawning stocks from tag returns. FiskDir. Skr. Ser. HavUnders., 16:339-358
- Dommasnes, A. 1984. Age distribution for spawning capelin 1954-1983. A review of some selected literature. Contribution to the joint Soviet/Norwegian symposium on the Barents Sea capelin, Bergen, August 1984. 9 pp. [Mimeo.]
- Dommasnes, A. and I. Røttingen 1984. Acoustic stock measurements of the Barents Sea capelin 1972-1984. A review. Contribution to the joint Soviet/Norwegian symposium on the Barents Sea capelin, Bergen, August 1984. 55 pp. + 8 pp. appendix. (Included in this volume).
- Dragesund, O., J. Gjørseter and T. Monstad 1973. Estimates of stock size and reproduction of the Barents Sea capelin 1970-1972. FiskDir. Skr. Ser. HavUnders., 16:105-139
- Forberg, K. 1982. A histological study of development of oocytes in capelin, Mallotus villosus (Müller). J. Fish Biol. 20:143-154
- Forberg, K. 1983. Maturity classification and growth of capelin, Mallotus villosus (M), oocytes. J. Fish Biol. 22:485-496.
- Forberg, K. and S. Tjelmeland 1984. Maturity studies of Barents Sea capelin. Contribution to the joint Soviet/Norwegian symposium on the Barents Sea capelin, Bergen, August 1984. 10 pp. (Included in this volume).
- Gjørseter, H. 1984. Growth of the Barents Sea capelin of the year-classes 1975-1981. Contribution to the joint Soviet/Norwegian symposium on the Barents Sea capelin, Bergen, August 1984. 21 pp. (Included in this volume).
- Gjørseter, H. and H. Loeng 1984. Growth of the Barents Sea capelin in relation to water temperature 1977 to 1983. Contribution to the joint Soviet/Norwegian symposium on the Barents Sea capelin, Bergen, August 1984. 7 pp. [Mimeo.]
- Hamre J. and S. Tjelmeland 1982. Sustainable yield estimates of the Barents Sea capelin stock. Int. Coun. Explor. Sea C. M. 1982 H:45 17pp + 7 pp. with tables and figures. [Mimeo.]
- Monstad, T. 1971. Alder, vekst of utbredelse av lodde (Mallotus villosus) i Barentshavet og ved kysten av Nord-Norge 1968-1970. Hovedfagsoppgave i marin biologi, Universitetet i Bergen. 80 pp. (In Norwegian) [Mimeo.]

- Olsen, S. 1968. Some results of the Norwegian capelin investigations 1960-1965. In: Blacker, R. V. (ed.). Symposium on the ecology of pelagic fish species in Arctic waters and adjacent seas. Rapp.P.-v.Reun.Cons.perm.int.Explor.Mer , 158:18-23.
- Prokhorov, V. S. 1965. Ecology of the Barents Sea capelin (Mallotus villosus (Müller)) and prospects for its commercial utilization. Fish. Res. Bd. Can. Trans. Ser., No. 813:1-131 [Mimeo.]
- Salvenes, A. G. V. 1984. Fordelingsmønster og dødelighet av lodde-larver, samt berekning av gytebestand, basert på larveundersøkelsane langs Troms- og Finnmarks-kysten 1972-1976. Hovudfagsoppgåve i fiskeribiologi. Universitetet i Bergen. 111 pp. (In Norwegian) [Mimeo.]
- Tjelmeland, S. 1984. The capelin assessment model - a documentation. Contribution to the joint Soviet/Norwegian symposium on the Barents Sea capelin, Bergen, August 1984. 16 pp. (Included in this volume).

POPULATION FECUNDITY AND YEARCLASS ABUNDANCE
OF THE BARENTS SEA CAPELIN IN 1972-1984

by

V.P Serebryakov^{*}, N.G Ushakov^{**}, V.K Aldonov^{*} and A.V Astaf'eva^{*}

^{*}All-Union Reserch Institute of Marine Fisheries and Oceanography
/VNIRO/, Moscow, USSR.

^{**}Polar Reserch Institute of Marine Fisheries and Oceanography /PINRO/
Murmansk, USSR.

ABSTRACT

The population fecundity (PF) is the total number of eggs spawned by all mature females in a given year. With the aim of estimating the PF of capelin in 1972-1984, data on individual absolute fecundity of fish at ages 2, 3, 4 and 5 years, yearclass abundance, the ogives of maturation and sex ratio were used.

1. INTRODUCTION

The PF was at maximum in 1976 ($3182,7 \times 10^{12}$ eggs) and at minimum in 1984 (453×10^{12} eggs), averaging 1737×10^{12} eggs during the period under study. The yearclass abundance of three year-olds was highest in 1972 ($5,5 \times 10^{12}$ individuals) and lowest in 1975 ($1,8 \times 10^{12}$ individuals). The survival rate (SR) expressed as the number of 2-year-old fish versus the total number of spawned eggs, i.e. the population fecundity, ranged from 0,00817 % (the 1975 yearclass) to 0,02870 (the 1972 yearclass). The SR value is assumed to be a general indicator of survival conditions during the early ontogenesis. This index was used for estimating different PF levels which provide an optimum recruitment under survival conditions of three categories.

This paper represents an attempt to analyze the population fecundity and abundance of subsequent yearclasses of capelin for the passed 13 years.

2. MATERIALS AND METHODS

By 'population fecundity' (PF) the authors mean the total number of eggs spawned by all mature females in a given year, (Anokhina, 1969; Polyakov, 1971).

With the aim of estimating the PF of capelin, data on the individual absolute fecundity (IAF) at ages 2, 3, 4 and 5 years, the abundance of every yearclass at age and the ogive of maturation were used. Sex ratio in the mature stock is taken to be 1:1.

It is a common knowledge that the IAF value of capelin, as in the case of other fish, increases with increasing body weight and length (Rumyantsev, 1947; Shilin, 1970; Galkin and Kovalev, 1975; Savicheva, 1975; Bakanev and Tereshchenko, 1983). Thus, different authors who studied the IAF of the Barents Sea capelin cite different values which may result from variation in the capelin growth rates during the years under study. Posdnyakov (1957) presented the average IAF of the Barents Sea capelin as equal to 10 764 eggs, varying from 4,5 to 22 thousand eggs in some females. Suvorov, Vadova and Synkova (1931) gave an estimated average IAF of capelin as 8252 eggs. Ushakov and Galkin (1983) reported that the IAF of capelin varied widely (from 9,9 to 14,4 thousand eggs). Data for the assessment of the PF were taken by the authors from a paper by Galkin and Kovalev (1975) in which the IAF of capelin is considered by different agegroups.

3. RESULTS AND DISCUSSION

Based on the above mentioned data, the contribution of every agegroup forming a part of the spawning stock to the PF value (CPF) has been estimated (Table 1).

For the past 13 years (1972-1984) the PF of capelin varied from $3182,7 \times 10^{12}$ in 1976 to $453,1 \times 10^{12}$ eggs in 1984. The average PF of capelin was equal to $1737,0 \times 10^{12}$ eggs, a value not exceeded in 1973 and 1974 and after 1978. For the last three years (1982, 1983 and 1984) the PF was less than 1000×10^{12} eggs, lower than ever before (Table 1).

During the whole period under study, the CPF of different yearclasses varied widely. In 1974, 1978 and 1979 the highest CPF was contributed by fish at the age of 3, while during the other 10 years the maximum CPF was due to 4-year-olds. The largest CPF resulted from the rich 1972 and 1976 yearclasses. Thus, in 1975 CPF of the 1972 yearclass constituted $1054,5 \times 10^{12}$ eggs and in 1976 it was equal to $1632,0 \times 10^{12}$ eggs, while the 1976 yearclass yielded $689,6 \times 10^{12}$ eggs in 1979 and in 1980 $748,0 \times 10^{12}$ eggs (Table 1). It should be noted that the 1976 yearclass made maximum contribution twice during its life span in comparison with other yearclasses which participated in spawning at the same time. During the period from 1972 to 1981, abundant yearclasses over $3,5 \times 10^{11}$ two-year-olds were observed only twice, in 1972 and 1976. Average yearclasses from $2,5$ to $3,5 \times 10^{11}$ two-year-olds appeared in 1973, 1977 and 1980, while poor yearclasses with less than $2,5 \times 10^{11}$ two-year-olds were registered 5 times (in 1974, 1975, 1978, 1979 and 1981; Table 2). Abundant yearclasses appeared in the years characterized both by a very high PF (the 1976 yearclass from a PF= $3182,7 \times 10^{12}$ eggs) and when the PF was close to the mean value from 1972 to 1984 (the 1972 yearclass with PF= $1916,4 \times 10^{12}$ eggs). The survival rates of these yearclasses as defined earlier were 0,01162 and 0,02870 %, respectively.

Average yearclasses were registered in the years with a below-average PF (1973 and 1980) and in a year with above-average PF (1977). The survival rates of these yearclasses at the age of two years were 0,02102, 0,02377 and 0,01460 %, respectively (Table 2).

Poor yearclasses were observed not only in the years with a low PF (1974), but also in the years with a high PF (1975), as well as in the years with PF close to an average level (1981)(Table 2).

The number of two-year-olds in the 1972-1981 yearclasses varied from $1,80 \times 10^{11}$ individuals (1975) to $5,50 \times 10^{11}$ individuals (1972). The survival rate of the abundant 1972 yearclass differs from that of the poor 1978 yearclass by almost three times though their levels of PF are almost the same.

On the other hand, although almost the same survival rate was observed in 1976, 1977, 1978, 1979 and 1981 their abundance differed: 1977 was an average yearclass, 1976 an abundant yearclass and 1978, 1979 and 1981 were poor yearclasses. In the first two cases the PF was considerably higher than in 1978, 1979 and 1981.

The survival rate (SR) may be considered as an integrated indicator of the environmental conditions affecting development and survival of the capelin during the embryonal, larval and fry periods of their life. The SR value of over 0.020 % correspond to survival conditions which are considered to be favorable and lead to abundant yearclasses; values from 0.014 to 0.020 % correspond to conditions when average yearclasses are registered; and values less than 0.014 % indicate that poor yearclasses are very likely to emerge.

Survival conditions favorable for abundant yearclasses were recorded in four cases, but it was only in 1972 when an abundant yearclass was observed. The other three years produced two average yearclasses (1973 and 1980) and one poor yearclass (1974). Survival conditions characteristic for average yearclasses were registered only once in 1977 when an average yearclass actually emerged. Conditions under which poor yearclasses might be expected were registered in 5 cases, of which poor yearclasses were recorded four times (1975, 1978, 1979

and 1981). Only in 1976, when the level of PF was the highest of the whole period of investigation, did an abundant yearclass form even though the survival rate was low. Based on the ecological conditions (SR) during the period under study, it might be expected that at least three rich yearclasses would emerge (in 1973, 1974 and 1980), but this did not occur as the PF value was not high enough.

It is not probable that survival conditions may restrict spawning stock to only poor yearclasses. The PF of such a hypothetical spawning stock is equal to 321.1×10^{12} eggs, a value almost twice as low as that recorded in 1982 and close to that estimated for 1984 (Table 1). When the level of PF is that low, even the most favorable survival conditions in the early ontogenesis will reduce the number of two-year-olds to 0.92×10^{11} individuals, an abundance lower than any observed during the period of study. It is evident from this situation that when the spawning stock of capelin consists only of poor yearclasses there is no reason to believe that an average yearclass could be produced.

Using the SR as a general criterion of the ecological conditions in early ontogenesis, it is possible to determine which levels of PF would secure optimum recruitment under survival conditions of three categories (favorable, average, unfavorable).

The minimum value of PF needed to produce an abundant yearclass under unfavorable conditions is estimated to be 4284×10^{12} eggs. This level is almost 1.5 times as high as the greatest value of PF during the whole period investigated. Under average conditions (SR=0.014-0.020 %) the population fecundity must be from 1750 to 2500×10^{12} eggs to ensure an abundant yearclass.

The critical level of population fecundity (CriPF) is estimated to be 1219.5×10^{12} eggs. Any decrease of this value would result in a less-than-abundant yearclass even under the most favorable environmental conditions. In 1974 and 1980 the PF value was found to be close to the CriPF and in both cases poor yearclasses were registered though the survival conditions were favorable. PF values lower than the CriPF were observed in 1982, 1983 and 1984 which eliminates the appearance of abundant yearclasses in spite of favorable ecological conditions in early ontogenesis.

4. REFERENCES

- Anokhina L.E, 1969. Regularities in fish fecundity variability. 'Nauka', Moscow, p.291.
- Bakanev V.S, Tereshchenko E.S, 1983. Fecundity of the Newfoundland stock of capelin. Col.'Biology of and fishery for pelagic fishes in northern seas', Murmansk, p.3-11.
- Galkin A.S, Kovalev S.M, 1975. Fecundity of the capelin Mallotus villosus from the Barents Sea. 'Vopr.Ikhtiol.' vol. 15, No.4/93/, p.646-651.
- Pozdnyakov Yu. F, 1957. On the capelin fecundity from the Barents Sea. 'Dokl.AN USSR', vol.112, p.777-778.
- Polyakov G.D, 1971. Quantitative estimate and adaptation meaning of fecundity variability and reproduction rates of fish populations. Col.'Regularities in fish growth and maturation', 'Nauka', p.5-20.
- Rumyantsev A.I, 1947. Capelin of the Sea of Japan. Izv.TIRKh, vol.22, p.35-74.
- Savicheva E.A, 1975. Fecundity of the capelin from the eastern Sea of Okhotsk. Col.'Investigations on fish biology and fishery oceanography', Vladivostok, TINRO, No.6, p.70-75.
- Serebryakov V.P, Aldonov V.K, Borisov V.M, 1982. Fecundity of the Arcto-Norwegian cod spawning populations. ICES C.M. 1982/G:19, p.1-9.
- Suvorov E.K, Vadova L.A, Synkova A.I, 1931. Biology of capelin. Tr. of Leningrad Research Ichthyological Institute, vol.2, pp.51-63, 67-104.
- Shilin Yu.A, 1970. Some biological features of the capelin, Mallotus villosus, from the northern Sea of Okhotsk. Izv. TINRO, vol.71, p.231-239.
- Ushakov N.G, Galkin A.S, 1983. Stock abundance structure and dynamics of the capelin from the Barents Sea. Col. 'Biology of and fishery for pelagic fishes from northern seas', Murmansk, p.100-115.

Table 1. Population fecundity (PF) of capelin in 1972-1984 (x 10⁻¹² eggs)

| Age | YEAR | | | | | | | | | | | | | average PF | % of total average PF |
|-------------|--------|--------|--------|--------|--------|--------|--------|--------|--------|--------|-------|-------|---------|---------------|--------------------------|
| | 1972 | 1973 | 1974 | 1975 | 1976 | 1977 | 1978 | 1979 | 1980 | 1981 | 1982 | 1983 | 1984 | | |
| 2 | 4.7 | 11.8 | 108.6 | 41.9 | 161.1 | 108.6 | 4.1 | - | - | 9.4 | 4.1 | 5.2 | (5.5) | 35.8 | 2.3 |
| 3 | 702.7 | 393.6 | 736.4 | 1054.5 | 999.6 | 743.7 | 873.3 | 689.6 | 491.2 | 393.6 | 180.4 | 287.0 | (185.5) | 594.7 | 37.9 |
| 4 | 884.0 | 952.0 | 136.0 | 1088.0 | 1632.0 | 952.0 | 680.0 | 680.0 | 748.0 | 1088.0 | 326.4 | 432.6 | (260.3) | 758.4 | 48.4 |
| 5 | 325.0 | 260.0 | 65.0 | 19.5 | 390.0 | 455.0 | 325.0 | 130.0 | 65.0 | 195.0 | 91.0 | 0.1 | (2.3) | 178.7 | 11.4 |
| Total PF | 1916.4 | 1617.4 | 1046.0 | 2203.9 | 3182.7 | 2259.3 | 1882.4 | 1499.6 | 1304.2 | 1686.0 | 601.9 | 724.9 | (453.1) | 1567.6 | 100.0 |

Table 2. Survival rates of capelin yearclasses up to age 2 from 1972 to 1981.

| Year-class | Population fecundity /PF/ x 10 ⁻¹² eggs | Number of 2-year-olds x 10 ⁻¹¹ ind. | Yearclass abundance | Survival rates (#3-year-olds vs PF) | Survival conditions |
|------------|--|--|---------------------|-------------------------------------|---------------------|
| 1972 | 1916.4 | 5.50 | abundant | 0.02870 | favorable |
| 1973 | 1617.4 | 3.40 | average | 0.02102 | favorable |
| 1974 | 1046.0 | 2.40 | poor | 0.02294 | favorable |
| 1975 | 2203.9 | 1.80 | poor | 0.00817 | unfavorable |
| 1976 | 3182.7 | 3.70 | abundant | 0.01162 | unfavorable |
| 1977 | 2259.3 | 3.30 | average | 0.01460 | average |
| 1978 | 1882.4 | 2.00 | poor | 0.01062 | unfavorable |
| 1979 | 1499.6 | 1.95 | poor | 0.01300 | unfavorable |
| 1980 | 1304.2 | 3.10 | average | 0.02377 | favorable |
| 1981 | 1686.0 | 2.00 | poor | 0.01186 | unfavorable |
| 1982 | 601.9 | | | | |
| 1983 | 724.9 | | | | |
| 1984 | 453.1 | | | | |

THE CAPELIN ASSESSMENT MODEL - A DOCUMENTATION

By

Sigurd Tjelmeland

Institute of Marine Research
P.O. Box 1870,
N-5011 Bergen, Nordnes
Norway

ABSTRACT

The mathematical model used for management of the Barents Sea is documented. The model is used for predicting the evolution of the stock to evaluate the consequences of various catch quotas.

1. INTRODUCTION

Giving advice on harvesting the capelin stock involves measuring the actual stock abundance and evaluating the impact of a possible catch quota. This is done each year in September during a joint Soviet/Norwegian cruise, which is followed by recommendations for the total allowable catch (TAC) in the coming regulation period. The present regulation strategy aims at maintaining the spawning stock at 0.5 mill. tonnes, although other strategies are conceivable, for instance, keeping the autumn stock as measured in September at a certain level.

At the Marine Research Institute a mathematical model of the Barents Sea capelin stock is used in conjunction with management. This model is used in three different ways:

Based on the acoustic estimate of the stock obtained during the September cruise, the future state of the stock is predicted as a function of future catches. These calculations then serve as a basis for giving TAC advice.

Based on historical data, acoustic estimates as well as catches, the stock size and stock structure is calculated from September to September. The outcome is then compared to the measurement to determine optional values for the various parameters in the model. Such parameters govern the effect on the stock of natural mortality, growth etc. To use the model this way, a program compares model outcome and stock measurement.

The model can also make long-range predictions based on arbitrary historical measurements of the stock as starting point. Runs for over 50 years show that after a transient period of 5-10 years, the model autumn stock and spawning stock stabilizes. By making a series of runs, each with different levels of catch, the maximum sustainable yield (MSY) can be found. By observing which level of the spawning stock (or, alternatively, the standing stock in the autumn) corresponds to MSY, one obtains a guideline for regulation.

In order to build a model package capable of handling the three-step management task outlined above, two models are necessary:

Basic model: This model describes the evolution of the capelin stock over one year beginning with measurements taken in September. The basic model is a collection of the maturation, mortality and growth models.

Recruitment
model:

In order to describe the evolution of the capelin stock for more than one year, the basic model must be augmented with a recruitment model. The recruitment model is fully endogenous, i.e. the recruitment is calculated on the basis of outputs from the basic model only, and consists of the submodels of recruitment in total numbers and the length distribution of recruiting yearclass.

In a management situation, values other than those actually estimated may be used, such as when long-term changes in the population cannot be accounted for by the model. Then the time period used for estimation may not be representative for the actual situation. This is the case with capelin growth, which is dependent on geographical distribution. Therefore, the model accommodates interactive changes of parameter values.

In section 2 the submodels of the basic model are described. Section 3 deals with the recruitment model. Section 4 deals with parameter estimation and data communication and (hopefully) gives the reader a feeling of the model's accuracy and applicability. Sections 5 and 6 deal with the use of the model in management. For detailed documentation of the computer implementation of the model a special manual is provided.

2. THE BASIC MODEL

2.1 Population layout

How detailed the population should be described is dependent on both the quality of the available data base and how broad the aspects of population dynamics which are considered vital for the management.

In accordance with these considerations the number of capelin is divided into age groups 2-5 and length groups ranging from 7.5 cm to 20.0 cm in .5 cm intervals.

The division on length groups is necessary in order to build a maturation model, which must be length-dependent.

Age groups enable the calculation of the spawning biomass each year, and the establishment of a recruitment model. The 2-year-olds are the youngest to be accurately measured, while the upper age limit of 5 years is chosen because the measurement of older fish becomes uncertain due to insufficiency of data caused by a high mortality of 5-6 year old fish.

The population is further divided into mature and immature in October-March. The implementation of the model could also keep track of the mean weights within each length group, which are at present calculated from the lengths and the total biomass of the population.

2.2 Submodels

2.2.1 Maturity

As it is assumed that maturation is more dependent on length than on age, the simplest model is then to use length at maturity, above which all fish are maturing. Thus, if the maturation length is, for instance, 13.8 cm, then 60% of the fish in the 13.5-14.0 cm group is allocated to the immature part of the population and 40% to the maturing part of the population.

2.2.2 Mortality

2.2.2.1 Spawning mortality

A constant fraction of the spawning population is assumed to survive and remain part of the total population the following autumn. For the time being, this fraction is set to zero.

2.2.2.2 Non-spawning natural mortality

The part of the population lost due to natural (i. e. not fishing) causes apart from death by spawning, is assumed at each instant to be proportional to the population. That is, the equation

$$\frac{dN}{dt} = -M \cdot N$$

familiar from the traditional VPA technique is used. Here, N is the population in numbers, t is the time, M is a parameter later to be estimated from the data. The equation above is applied to each cell in the length-age space.

2.2.2.3 Fishing mortality

The equation used is similar to the one used for natural mortality:

$$\frac{dN}{dt} = -F \cdot N$$

Here F is a constant, the so-called fishing mortality. However, this equation is used in different ways according to whether the model is run for a time period for which there are catch records or whether it is used to predict the future. If the model is run into the future, the above equation is used as it is and the program asks the operator for a value of the parameter F. If the model is used for a past period with catch data, the program calculates the value of F from the familiar catch equation used with VPA-analysis:

$$C = \frac{N \cdot F}{F + M} \cdot (1 - \exp(-(F + M)))$$

Here, N is the number of fish at the start of the time step, usually

one month, and C is the catch in numbers. The same F applies to all length groups although the equations above are used for each age group separately.

2.2.3 Growth

The growth of the immature population from September to September and the growth of the mature population from September to April must be handled separately.

2.2.3.1 Growth of the immature population

The choice of model is the simplest possible. The length increment per time unit is assumed constant for all length groups and all age groups. In addition a possibility for density-dependent growth reduction is provided. The data available give no room for sophistication concerning the actual form of the density-dependence, so any mathematical function reducing the growth monotonically with increasing population might suffice. To calculate the growth we have chosen the mathematical function:

$$\frac{dl}{dt} = A_1 \cdot (1 - (B/B_1)^2) \cdot (1 - (N/N_1)^2)$$

Here, l is the length, A₁, B₁ and N₁ are constants to be estimated from the data and B is the total biomass of the population. The other parameters are:

- A₁ Maximum growth
- B₁ Density-dependence (biomass)
- N₁ Density-dependence (total number of fish)

As the length of the fish is not a modelled entity, the implementation of the above equation assumes that fish are moved upwards through the length groups so that the validity of the equation above is retained.

The model provides no independent equation for growth in weight. Growth in length and growth in weight are linked together through the equation

$$w = A_w \cdot l^{C_w} \cdot (1 - (B/B_w)^2) \cdot (1 - (N/N_w)^2)$$

Here, w is the mean weight in each length group. Density dependence enters through the dependence on l as well as directly.

2.2.3.2 Growth of the mature population

There are no equations similar to the ones above for the growth of the mature population. However, it is possible to increase the mean weight per age group by some fraction, using data on mean weight in the spawning population together with calculated mean weights of the mature population in the autumn. This is no trivial task, however, since these weight increase functions will be dependent on the length at maturity used.

The model program provides an opportunity for calculating these weight correction factors interactively for a given range of years.

2.2.3.3 The actions of the basic model

When the basic program starts to run a one year cycle, all parameters are assumed to have their correct values. When the program is used as a stand-alone model, a special communication module enables the operator to check the parameter values and make necessary changes. When the program is used by other programs, these programs furnish the correct parameter values.

The simulation is performed according to the following scheme:

The population data are read in from the data file. This includes the number of fish per age and length group and the mean weight in each length group.

The catch data in numbers by month and age group is read in from data file.

The population at December 31. is calculated by reducing the initial population by the natural mortality and catch.

The population is split into a mature and an immature part.

The catch data for the next year is read in from the catch data file.

The spawning population by March 31. is calculated by reducing the mature population by the catch and natural mortality for the months January-March. The spawning biomass is calculated. If the basic model is used with programs where the recruitment model is used, the recruiting population is calculated.

The immature part of the population is calculated from January 1. to September 31. by reducing by the natural mortality for the whole period and by the fishing mortality for the autumn season. The growth is calculated for the part of the time that falls within the growth period.

3. THE RECRUITMENT MODEL

The recruitment model is composed of two parts: recruitment in total number and the length distribution of the recruiting yearclass.

3.1 Recruitment in total number

The traditional Beverton-Holt function is used:

$$R = N_r \frac{B}{B_r + B}$$

Here, N_r is the maximum recruitment and B is the spawning stock biomass. B_r is the value of the spawning stock biomass producing a recruitment of half the maximum value. This function leads to a recruitment proportional to the spawning stock at small values and to an asymptotical recruitment of N_r at high values of the spawning stock.

3.2 The length distribution of the recruiting yearclass

The data show that, as a general rule, the mean length of the recruits is smaller in years of abundant recruitment than in years of a weak recruitment. This density-dependent growth of the recruiting yearclass is correlated more to the abundance of the recruiting yearclass than to the abundance of the total stock.

The length distribution of the recruiting yearclass may be of great significance when using the model for management. It directly influences the contribution of 3 year old fish to the spawning stock of the next year. Being the initial length for the bulk of the forthcoming spawning population the next year, it influences the TAC for the autumn fishery. The manager using this model should take particular care for how this part of the program works.

The length distribution of the recruiting yearclass is built up by pooling together historical length distributions of 2-year-old capelin. For details of this procedure see section 4.5.

The formula for the total number of the recruiting yearclass has been constructed by using the observed strengths of 2-year-old fish. No provision has been made for adjusting the fishery on this yearclass prior to the time of measurement, since the relative impact in August and September has been very small, compared to other sources of uncertainty. However, in periods when the mean age of the stock is low, as is the present situation, this may well not be true. So when the model is being re-parameterized using data also after 1980 effort should be directed into removing this source of error.

4. PARAMETERIZATIONS AND DATA DOCUMENTATIONS

So far, the description of the management model for Barents Sea capelin has only dealt with the basic modelling of the stock over a one year period. However, the model may give different results, depending on the values of the parameters. We will find the values of the parameters controlling the model output, which is a function of the measurement of the stock one year earlier as well as of the model

itself, resemble the actual measurement of the stock most closely. To this end, two problems must be solved:

The deviation between model output and measurement must be quantified.

A method must be found for varying the parameters and selecting the set of parameter values giving the smallest deviation between model and measurement.

The latter problem is easily solved by using a standard program called MINUIT, developed at the high-energy research center at CERN, Geneva. Although developed for solving problems of high-energy physics, this program is of general use, and well suited to the kind of parameter estimation described in this paper.

The expression for the deviation between model and measurement (the so-called goal function) depends on an understanding of the probability laws applicable to the model outputs. We will here take a pragmatic approach and use goal functions that give good estimates of the parameters, but where it is not possible to estimate the range of uncertainty.

4.1 Length at maturity and natural mortality

Understanding maturation is the most essential process in managing the Barents Sea capelin fishery effectively. The length at maturity affects both the total number and the mean length of the immature and mature part of any yearclass. Therefore, both these two quantities might be used to determine the most accurate value of the maturation length. However, the mean length is also affected by the growth.

In order to estimate the maturation length as independently of other processes as possible, we will compare the age distributions of the model output to the measurements. This age distribution is strongly affected by the length at maturity, the widely different initial length distributions of different age groups, and by the natural mortality. It is not possible to escape inter-parameter correlation totally. We will estimate the length at maturity and natural mortality simultaneously with the goal function, which has the advantage that these two properties are not too closely coupled. The length at maturity has a strong influence on both the absolute level of the stock and the age distribution of the stock, whereas the natural mortality affects the absolute level strongly and the age distribution only slightly. We use:

$$F(l, M) = \text{SUM}((S_3/N_3 - 1)^2 + (S_4/N_4 - 1)^2)$$

Here:

$F(l, M)$ is the goal function to be minimized

S_3, S_4 the model output of 3- and 4-year-old capelin (no. ind.)

N_3, N_4 the measurements of 3- and 4-year-old capelin (no. ind.)

S_3 and S_4 are dependent on l (length at maturity) and M (natural mortality).⁴ The values are summed for the years 1973-1980. This period of time is also used for estimating the other parameters of the model.

The numbers of 3- and 4-year-old capelin measured and predicted by the model using the estimated parameters are given in the table below:

The capelin assessment model - a documentation

3-year-old fish (10^7)

| | 1974 | 1975 | 1976 | 1977 | 1978 | 1979 | 1980 |
|-----------|-------|-------|-------|-------|------|-------|-------|
| Predicted | 17498 | 26595 | 15651 | 8184 | 6548 | 16833 | 14342 |
| Measured | 17925 | 30407 | 16733 | 10171 | 7585 | 11249 | 15413 |

4-year-old fish (10^7)

| | 1974 | 1975 | 1976 | 1977 | 1978 | 1979 | 1980 |
|-----------|------|------|------|------|------|------|------|
| Predicted | 167 | 6287 | 8938 | 2852 | 895 | 721 | 1923 |
| Measured | 356 | 8790 | 7844 | 4159 | 886 | 478 | 3262 |

It is seen that, as a rule, there is good correspondence between model predictions and measured values. However, there are anomalies of which the year 1979 is the most pronounced. The deviations between predicted and measured values fluctuate more for 4-year-old fish than for 3-year-old fish.

4.2 Growth

Growth in length is more important to management than growth in weight, since the spawning stock in numbers is directly dependent on the length distribution through the use of the length at maturity. Once the length at maturity has been estimated, the model's mean lengths are dependent on the growth only. Both the growth in length and in weight are estimated by constructing a least squares function similar to the one used for estimating length at maturity. The predicted and measured values for the mean length are given in the table below:

3-year-old fish (cm)

| | 1974 | 1975 | 1976 | 1977 | 1978 | 1979 | 1980 |
|-----------|------|------|------|------|------|------|------|
| Predicted | 14.0 | 13.7 | 14.5 | 15.3 | 14.9 | 14.3 | 14.9 |
| Measured | 12.7 | 13.4 | 14.1 | 15.0 | 14.8 | 14.2 | 15.3 |

4 year old fish (cm)

| | 1974 | 1975 | 1976 | 1977 | 1978 | 1979 | 1980 |
|-----------|------|------|------|------|------|------|------|
| Predicted | 16.1 | 14.3 | 15.3 | 15.8 | 15.9 | 15.8 | 15.9 |
| Measured | 16.0 | 15.1 | 15.3 | 15.9 | 16.0 | 16.0 | 16.6 |

The deviation of prediction from measurement is largest in 1980, a year of substantial growth. The low mean length of 3-year-old fish measured in 1974 gives rise to large deviations for the predicted mean lengths of those fish in 1974 and in 1975.

4.3 Fishing mortality pattern

As mentioned earlier, when the basic model is being used for a past period, the catches are transformed into numbers of fish by age-group and month. When the model is being used for prediction, the operator selects the F-value to be used. However, a fishing mortality pattern has to be defined. The mortality is calculated by dividing the historical catches per age group by the estimated numbers of the same age group and averaging over a range of years. The fishing pattern will thus be slightly dependent on the maturation length and natural mortality. With the values of length at maturity and natural mortality currently being used for management the fishing pattern presently in use is 0.045, 0.081, 0.116 and 0.158 for 2-, 3-, 4- and 5-year-old fish. These values are then scaled up or down by the F-value given by the operator. It should be noted that when running the model into the future, the entity of interest is the "F-output biomass". The F-value merely is a control variable.

The model program allows for an interactive calculation of the fishing mortality pattern for a given range of years.

4.4 Recruitment

The parameters of recruitment are estimated in two steps: Firstly, the spawning stock biomass is calculated throughout the time period of interest, using the model and the estimated value of the maturing length. Then the parameters are estimated by comparing the recruitment calculated by using the recruitment function to the observed numbers of 2 year old fish for the corresponding yearclass. The result is shown in figure 1.

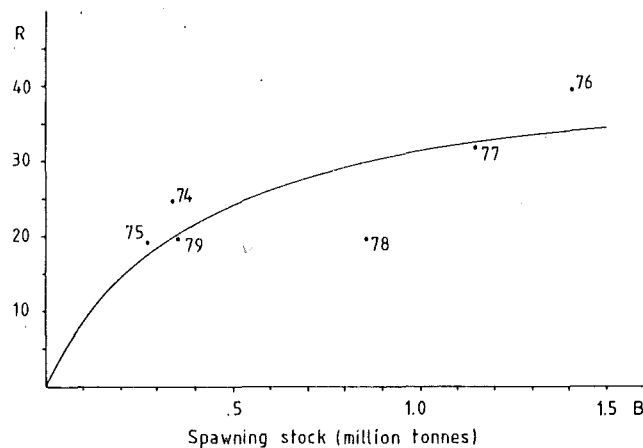


Figure 1. Stock-recruitment relation of Barents Sea capelin. The solid line shows the function $R = \frac{44.5 \cdot B}{0.43 + B} \cdot 10^{10}$ where R is the number of recruited individuals and B is the spawning stock in million tonnes. (Hamre and Tjelmeland, 1982).

It must be noted that the parameters of the recruitment relation are dependent on the length at maturity and weight correction factors applied for the spawning stock.

4.5 Length distribution of recruiting yearclass

As noted in section 2, the length distribution of the recruited 2 year olds has a tendency to shift towards higher lengths when the strength of the yearclass is low. For an example, consider figure 2.

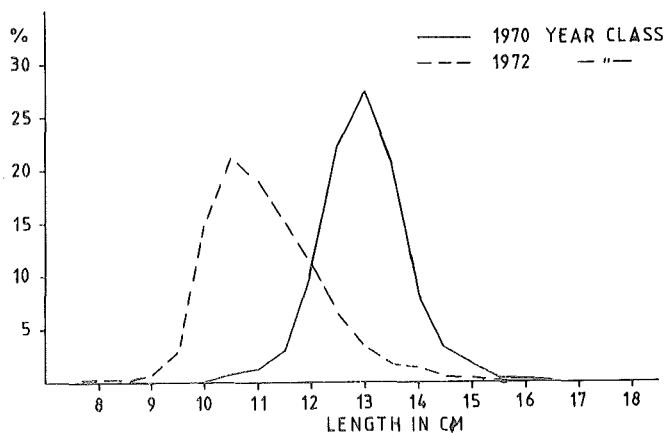


Figure 2. Length distribution of 2-year-olds in the 1970 and 1972 yearclasses of Barents Sea capelin.

Figure 3 shows the mean length of 2 year old fish and corresponding strength measured in total number of fish. The years pooled when constructing the length distribution of the recruiting yearclass are also shown.

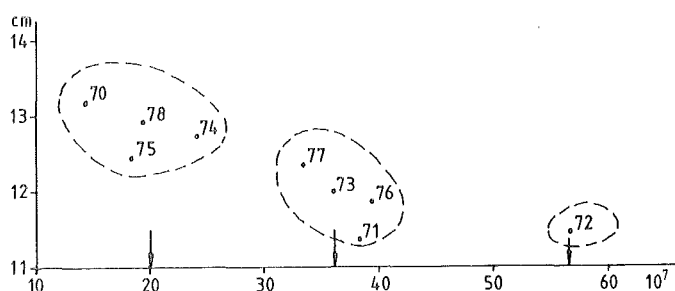


Figure 3. Mean length vs. stock strength of 2-year-olds in the yearclasses 1970-1978 for Barents Sea capelin. (Hamre and Tjelmeland, 1982).

The strength of the recruiting yearclass is used when constructing the length distribution of the recruiting yearclass. If the strength is equal to 20,36 or 56 x 10¹⁰ individuals, the length distribution from the yearclass clusters pointed to by arrows are pooled to form a length distribution for the recruits. If the strength is between these values an interpolation is performed, i. e. two neighbouring length distributions are added, with weights proportional to the difference between the strength of recruitment and the strength of the clusters.

5. MAXIMUM SUSTAINABLE YIELD

The basic model is augmented with the recruitment model. The result is a fully endogenous model. The model may then be run with different values of autumn and winter F-values and the corresponding values of mean spawning stock and mean F-output biomass may be found. The result is the yield curve for Barents Sea capelin shown in figure 4.

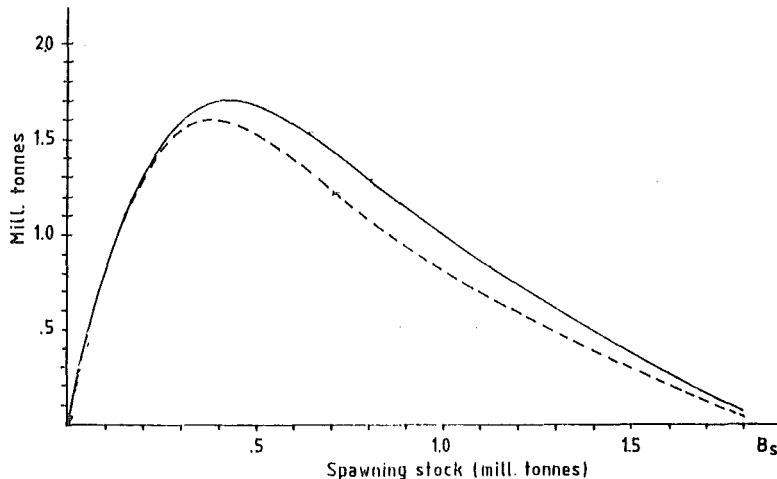


Figure 4. Sustainable yield for Barents Sea capelin at different levels of spawning stock (B_s). Broken lines apply to winter fishing only, solid lines to autumn fishing only.

It is seen that for winter fishing only the MSY is 1.6 mill. tonnes while for autumn fishing only the MSY is 1.7 mill. tonnes. In the first case the spawning stock is somewhat lower than 0.4 mill. tonnes, in the latter case somewhat higher.

6. PRACTICAL USE OF THE PROGRAMS WITH MANAGEMENT

In constructing this model, some very crude assumptions have been made. Vital aspects of the Barents Sea capelin dynamics have been omitted, including:

Sex-dependent growth

Sex-dependent maturing lengths

Age-dependent maturing lengths

Age- and sex-dependent spawning survival

Area-dependent growth in connection with observed change of distribution area

Time- and area variations of spawning migration, giving rise to strong fluctuations of larval growth and survival having in turn impact on recruitment function

Time change of predator species giving rise to time change of natural mortality

These are areas of current research, and eventually the model may take several or all of these effects into account. At the present level of development, the model must be used with caution and is therefore very flexible. There is provision for interactive change of

- Maturing length
- Natural mortality
- Recruiting yearclass of a particular year
 - This is specially useful when one wants to use the larval index as a guide to recruitment
- Growth
- Fishing mortality pattern
- Weight correction of mature population

7. REFERENCES

- Hamre, J. and S. Tjelmeland 1982. Sustainable yield estimates of the Barents Sea capelin stock. In. Coun. Explor. Sea C.M. 1982 H:45 17pp + 7 pp tables and figures. [Mimeo.]

ACOUSTIC STOCK MEASUREMENTS OF THE BARENTS SEA CAPELIN 1972 - 1984

A REVIEW

By

Are Dommasnes and Ingolf Røttingen
Institute of Marine Research
P.O. Box 1870, 5011 Bergen, Nordnes
Norway

ABSTRACT

This paper gives a review of the procedures currently used to obtain acoustic estimates of the Barents Sea capelin stock, as well as the development history of the procedures, their theoretical and technical basis, and the known sources of error. The results of the autumn surveys are given as tables and figures.

1. INTRODUCTION

Systematic acoustic surveys on the Barents Sea capelin (Mallotus villosus) started in 1971, and have continued in September-October every year since then. In principle, the same method has been used throughout this relatively long time series. The basic principle is to locate the capelin with an echo sounder, measure the total reflected echo intensity from the capelin recordings with an echo integrator, and finally to convert the integrator values to the number of fish and the biomass.

However, there have been major advances in electronics technology in this period. It is now possible to process signals derived from fish echoes fast and accurately, with equipment which is both reliable and stable.

Compared with the early 1970's more information is available today on the acoustic scattering properties and the behaviour of capelin, although more knowledge in these fields is still necessary.

For reports on the cruises 1971 - 1984 see Dragesund and Nakken, 1972; Gjørøster et al., 1972; Dommasnes et al., 1974; Buzeta et al., 1975; Dommasnes et al., 1975; Dommasnes and Røttingen, 1976; Monstad and Røttingen, 1977; Dommasnes et al., 1979; Mamylov and Dommasnes, 1979; and Anon., 1980; 1981; 1982; 1983; 1984.

The purpose of this paper is to sum up the results from the autumn acoustic surveys 1972-1984, as well as to give a description of the evolution of the method which has taken place as the acoustic instruments and calibration procedures improved together with the increased knowledge of the acoustic properties of fish.

2. METHODS

2.1 Conversion constant

Midttun and Nakken (1971) showed that when a scientific echo sounder, with certain specified instrument settings, works in conjunction with an echo integrator, the output is proportional to the observed fish density:

$$\rho = C \cdot M \quad (1)$$

where

$$\begin{aligned} \rho &= \text{fish density} \\ C &= \text{system conversion constant} \\ M &= \text{observed integrator value} \end{aligned}$$

The value of the conversion constant C can be determined through different methods, but not all of them apply to every species. However, in 1971, Midttun and Nakken published a method which could be applied to the Barents Sea capelin, consisting of finding the number of fish sampled by counting individual fish traces on the echogram. The sampling area was found by reducing the recorder gain. When the

echo sounder has a calibrated gain switch, the difference between the recorder gain at normal setting and the gain giving a just visible marking on the paper for the fish in question, is used to find the sampling angle (detection angle) in the directivity diagram for the echo sounder. However, a disadvantage with this method is the requirement of single fish traces, a condition that is seldomly found for the Barents Sea capelin in autumn. But, in 1971, 8 nautical miles (abbreviated to nmi) of single fish traces were obtained, and Fig. 1 gives the results from these countings (Midttun and Nakken 1977).

The system conversion constant is the key to the absolute biomass estimations, and Nakken (1975) showed that this constant depended on fish species, size, behaviour, and on the characteristics of the sounder and the integration system. It was convenient to write C as a product:

$$C = C_I \cdot C_F \quad (2)$$

C_I is an "instrumentation constant" depending on the instrument characteristics of the particular system in question.

C_F depends on the acoustic properties of the fish. The acoustic properties are described by the terms "target strength" (TS) or "backscattering cross section" (σ_{bs}).

The theory behind these terms is described in textbooks (Urick 1975) and manuals (Burczynski 1979, Johannesson and Mitson 1983). Using definitions from Dalen and Nakken (1983) we get:

$$TS = 10 \log \sigma_{bs} \quad \text{or} \quad \sigma_{bs} = 10^{0.1 TS} \quad (3)$$

(See also Appendix I)

The backscattering cross section of an individual fish varies with fish species, length and aspect (The angle between the longitudinal axis of the fish and the acoustic axis). It has been determined empirically for a number of species and sizes (Midttun 1982). The backscattering cross section for one fish of a given species can be expressed as a function of fish length, l:

$$\sigma_{bs} = a \cdot l^b \quad (4)$$

where a and b are determined empirically from observed values of σ_{bs} and l. The results have mostly been presented in logarithmic form using the target strength, TS, instead of the backscattering cross section.

$$TS = 10 \log \sigma_{bs} = 10 b \log l + 10 \log a \quad (5)$$

C_F is inversely proportional to the backscattering cross section

$$C_F = \frac{1}{\sigma_{bs}} \quad (6)$$

Combination of (2), (4) and (6) gives:

$$C = C_I \cdot C_F = C_I \cdot \frac{1}{\sigma_{bs}} = C_I \cdot \frac{1}{a \cdot l^b} = C_I \cdot \frac{1}{a} \cdot l^{-b} \quad (7)$$

and

$$p = C_F (C_I \cdot M) \quad (8)$$

If we put $\frac{1}{a} = C_S$, then:

$$C = C_I \cdot C_S \cdot l^{-b} \quad (9)$$

For the Barents Sea capelin this counting method has been used to establish C for certain fish lengths, and the constant $C_I \cdot C_S$ has then been determined by:

$$C_I \cdot C_S = \text{antilog} (\log C + b \log l) \quad (10)$$

The exponent b is determined from target strength measurements on single stunned or dead fish (Equations (4) and (5)). But when the present investigations began no target strength measurements of capelin were available. However, the capelin have common structural components with clupeiform fishes (herring, sprat, etc.) which are acoustically important (physostomous swim bladders, osseous skeleton, intermuscular bones, comparatively many vertebrae, fins without spines and cycloid scales). Due to the lack of specific acoustic information on capelin, it was decided to utilize data on the relationship of target strength and length for sprat (Nakken and Olsen, 1977) using the following relationship between target strength and length for sprat at maximum dorsal aspect:

$$TS_{\text{sprat}} = 17.2 \log l - 60.8 \text{ dB} \quad (11)$$

This equation is of the form

$$TS = 10b \log l + 10 \log a \quad (5)$$

giving the value 1.72 for the factor b .

The values for C obtained by countings of single capelin of different length groups in 1973-1975 are given in the text table below

$$C = 1.8 \cdot 10^6 \cdot l^{-1.72} \quad (1973) \quad (12)$$

$$C = 3.0 \cdot 10^6 \cdot l^{-1.72} \quad (1974) \quad (13)$$

$$C = 5.0 \cdot 10^6 \cdot l^{-1.72} \quad (1975) \quad (14)$$

The change in the conversion factor from year to year may be due to a drift in the acoustic system. The hydrophone calibration used in this period to measure the performance of the acoustic system was not a reliable procedure, and changes in performance were difficult to trace systematically. However, the change in the values of the conversion factor need not be due to instrument or technical factors alone. They may be due to differences in the behaviour (and acoustic properties) of the capelin when the counting calibration took place.

On the basis of combined target strength measurements of several clupeiform fishes, Dalen et al. (1976) suggested a value for b of 1.91.

In incorporating this new value of b , the requirement was set that the value for C should be the same for capelin of 13 cm using both 1.91 and 1.72

$$C_I \cdot C_S \cdot 13^{-1.91} = 5.0 \cdot 10^6 \cdot 13^{-1.72} \quad (15)$$

$$C_I \cdot C_S = 8.1 \cdot 10^6 \quad (16)$$

The C -value of $8.1 \cdot 10^6 \cdot 1^{-1.91}$ was applied in the period 1976-1982. In 1982 the Simrad EK 38 echo sounder was replaced by the EK 400 and the conversion factor had to be changed due to the different performances. By 1981, calibration on standard spheres had become an established routine, and the performances of EK 38 and EK 400 could be compared. The table below gives the measurements of energy reflected per nautical mile from the standard copper sphere of 60 mm.

| Date | Energy mm/nmi | Echo sounder |
|-----------|---------------|--------------|
| Oct. 1981 | 539 | EK 38 |
| Oct. 1982 | 2170 | EK 400 |

This, together with minor changes in performance of the EK 400 in 1982-1983 gave a conversion factor of $1.5 \cdot 10^6 \cdot 1^{-1.91}$ in January 1983 (Dalen and Nakken, 1983) and $2.2 \cdot 10^6 \cdot 1^{-1.91}$ in September 1983.

Prior to summer 1983 the conversion constant was given as equation 7. However, as standard sphere calibrations made it possible to calculate the value of C (see chapter on calibration), the conversion constant from summer 1983 was given as

$$\frac{1}{10a} \cdot 1^{-b} \quad \text{or} \quad \frac{1}{10} \cdot C_F \quad (\text{equation 23}).$$

Prior to this change, the established conversion factor was only for the system onboard the "G.O. Sars". However, the autumn surveys on Barents Sea capelin are conducted by many ships whose integrator values had to be transformed through intercalibration before the "G.O. Sars" conversion could be applied. As a consequence, distribution charts etc. were given in mm integrator deflection according to "G.O. Sars" values.

With the use of the instrument constant, the "integrator values" became system independent. The dimension for $C_T \cdot M$ (see equation 8) is m^2 / nmi^2 . C_F is also system independent and the dimension is m^{-2} .

2.2 Acoustic equipment and calibration

In order to monitor changes in the echo sounder system and, when needed, to restore the performance of the system, it is essential to have some method of calibration.

When the autumn surveys on Barents Sea capelin started, the calibration of the vital parameters of the echo sounder were done by measuring the performance in the transmitting mode with a hydrophone placed on the acoustic axis of the transducer, and then using the same hydrophone as a sound source to measure performance in the receiving mode. This method has been described by Forbes and Nakken (1972).

Experience has shown that this procedure is not reliable for field use due to the lack of stability over time for the calibration hydrophones. In 1975 an additional procedure was initiated, with measurement of the output voltage from the transmitting amplifier, the impedance in the transducer, and the amplification in the receiver system. These measurements were done several times during each cruise, and it was assumed that if these 3 values were kept constant, then the system performance did not change.

Since 1981 the performance and stability of the system has been checked at least once during each cruise by calibration with a standard target in the acoustic axis of the beam. In later years, a considerable amount of the field work and analysis has been done in order to find suitable standard targets, and it has been found that, for 38 kHz, a copper sphere with a diameter of 60 mm gives an accurate and reliable target strength (-33.7 dB) over the entire hydrographic range in question (Foote 1982). The calibration procedure is described in Foote et al. (1983). This calibration procedure, in contrast to earlier calibrations with hydrophones, seems to give consistently reliable results in measuring the stability of the echo sounder performance.

The introduction of the copper sphere as a standard target has made it possible to calculate the factor C_T in equation (2). The standard target has a known target strength (-33.6 dB). This value is calculated theoretically and is confirmed by field measurements.

From (3) we can calculate the value of σ_{bs} for the reference sphere:

$$\sigma_{bs} = 10^{0.1 \cdot (-33.6)} = 4.3 \cdot 10^{-4} \quad (17)$$

This may be thought of as a reflecting area, given in m^2 .

The integrator output from the standard target is known, and therefore C_I can be expressed as reflecting area in m^2 per $n.mile^2$ by use of the formula (Dalen and Nakken 1983):

$$C_I = \frac{\sigma_{ST}}{M_{ST} \cdot D_{ST} \cdot \psi} \cdot 3.43 \cdot 10^6 \quad (18)$$

where

σ_{ST} is the back scattering cross section of the standard target (m^2)

M_{ST} is the integrator output from the standard target (mm/nmi)

D_{ST} is the depth of the standard target (m)

ψ is the equivalent solid angle of the beam of the transducer (sterad)

$3.43 \cdot 10^6$ is the number of square meters in a squared nautical mile (used in order to have the density expressed as number of fish per square nautical mile).

The value of ψ is given by the transducer manufacturer. However, there is some evidence that this value may change when the transducer is mounted on the hull of the vessel (Simmonds, 1984). This can be an important source of error, and it may be necessary to develop a method for measuring ψ after the transducer has been mounted on the hull. The text table below gives values for C_I for the EK 400 equipment on "G. O. Sars".

| Date of measurement | C_I |
|---------------------|--------|
| 03.10 - 82 | 0.078 |
| 04.01 - 83 | 0.064 |
| 13.12 - 83 | 0.054 |
| 02.08 - 83 | 0.0814 |
| 29.09 - 83 | 0.0775 |
| 13.01 - 84 | 0.0833 |
| 15.03 - 84 | 0.0831 |
| 24.05 - 84 | 0.073 |
| 25.07 - 84 | 0.087 |

Significant deviations in the time varied gain (TVG) have previously been important sources of error. However, equipment and procedures for detecting the magnitude of the TVG error at different depths have now been developed (Knudsen 1982). The correction factors are entered into the integrator program, and output is then adjusted correspondingly.

A potential source of error in acoustic measurements of fish density is the absorption part of the time-varied-gain functions (α). Prior to 1982 (Echo sounders EK-38) the value of α was set to 0.0105 dB/m, based on Schulkin and March (1962). More recent studies (Fisher and Simmonds 1977, Foote 1981) indicate that these values are too high and at present a value of 0.008 dB/m is utilized. This is thought to reflect the average value of α in the Barents Sea in autumn.

If the calibration procedure outlined above is followed by all vessels participating in a survey, then the integrator outputs from all

vessels are directly comparable. However, if there has not been time to do a standard target calibration, or the necessary equipment or information on transducer performance (i.e. equivalent solid angle of the beam, ψ) is lacking, then systems must intercalibrate on fish recordings, (the old standard method) still seen as an efficient means for checking the standard target measurements. The procedure for this type of calibration is described by Røttingen (1978) and in a number of cruise reports. Fig. 2 shows the sailing arrangement which has given the best results.

The results from the intercalibrations have usually been in accordance with the results from the standard sphere measurements, with one important exception in the autumn 1982. During the capelin cruise that year the research vessels "G. O. Sars" and "Johan Hjort" participated from Norway. On board "G. O. Sars" a new EK 400 echo sounder had just been installed, and according to the standard sphere measurements the relation between the echo integrator output from "G. O. Sars" and "Johan Hjort" was approximately 2.5:1. However, an intercalibration on capelin recordings was also carried out during the cruise, and the relation between the integrator outputs from the two vessels was then 1:1. It was very difficult to interpret these contradicting results, and the cause of the discrepancy has still not been found. However, it could be documented that no change had taken place in the echo equipment of "Johan Hjort" since the year before, and it was therefore decided to use the conversion constant (C-value) from 1981 also in 1982. This may have caused an overestimate of the capelin stock in the autumn of 1982.

2.3 Fishing gear and sampling

The trawls used have been mostly pelagic trawls with a square opening of 14 x 14 or 16 x 16 fathoms, with small meshes ("capelin trawl"), and with an inner net with 1 cm mesh in the codend. In addition, a bottom trawl has sometimes been used (Fig. 3).

Capelin is usually found both in the codend and, if a pelagic trawl has been used, in the meshes. There is a tendency that capelin caught in the meshes are smaller than those found in the codend.

All the trawls have their own selectivity characteristics, which may be somewhat different from cruise to cruise due to small differences in the rigging of the trawls. Selectivity is a large complex with many interacting factors. Both passive (filtering) and active escape will take place and will change according to the speed of the trawl and the density of the fish concentration. Preliminary investigations of escape of capelin from different parts of the capelin trawl used by Norwegian research vessels have been carried out by attaching smallmeshed bags to different parts of the trawl (Larsen 1984). Fig. 4 summarizes the results, which indicate that when small and large capelin occur together in the catch, the small capelin will be underrepresented. For this reason it can be assumed that the one year old capelin are underrepresented in the acoustic estimates. An analysis of the calculated numbers of a yearclass for consecutive years during its lifetime leads to the same conclusion (Dommasnes 1981).

From each trawl catch a random sample is taken from the codend. Additional samples may be taken of the capelin caught in the meshes further forward in the trawl, but these are always considered non-

random. The size of the samples has been variable - in 1973 several hundred capelin were usually taken in each sample, but since 1975 the sample size has usually been 100 fish.

From a "full sample" the following data are usually recorded for each capelin: length, weight, sex, maturity, degree of stomach filling and degree of digestion, age from otoliths, and radius of the year-rings. All data are recorded on forms, after which they are entered into a computer and run through a test program that detects "illegal" data codes or "impossible" combinations of data values. Each sample is given a number which is later used as identification. For details on sampling and ageing see Gjøsæter, (1984).

2.4 Survey design

In 1971 when the cruises started, considerable information on capelin distribution was already available, both from earlier scientific surveys in the Barents Sea, and from fishing data. The survey grid which has been applied in these investigations is mainly a parallel grid with north-south transects. It can be described as a systematic grid pattern with a nonrandomly selected starting point. It was felt that the survey grid then adopted gave the most complete coverage within a reasonable time. If the time interval used for the survey was increased, the obtained distribution would become increasingly non-synoptic.

The same grid pattern, in principle, has been used every year. In later years, with more research vessel time available, the distance between course lines has been decreased.

Aglen (1983a) has analyzed the variations between abundance indices for different degrees of survey coverage. He defined the "degree of coverage" for an area as the ratio between sailed distance and the square root of the total area covered. Integrator output was used as the index of abundance. The result (Fig. 5) indicates that a further increase of survey effort will not improve the precision significantly.

2.5 Calculations

A flowchart of the procedure for evaluating data and calculating the results is given in Appendix II.

The calculations give stock size as numbers and biomass of each year-class, based on the integrator values and sample data from the trawl catches.

In order to organize data in a manageable form, the total area investigated is divided into a relatively large number of smaller areas. For this purpose we have used the basic "squares" used in Norwegian Fisheries statistics (Fig. 6). The center of each "square" is then the geographical reference point for all data assigned to that square.

For the acoustic data, a mean integrator value is calculated for each square, usually by calculating the mean of all integrator values obtained in that square. In some instances, particularly at the edge

of the area of distribution, it is often necessary to use some judgement to obtain "representative" values. The calculation of the mean integrator value for each square is done manually.

Many of the squares have no trawl stations, many have one only, and several squares have more than one. In order to get representative biological data for the recordings in each square, trawl stations selected from the square in question or from neighbouring squares are assigned to each square as the cruise proceeds. The main criterion for designating trawl stations to a square is the similarity of echo recordings. Often several types of recordings are found in one square, and must then be represented by several trawl stations. When trawl stations have been assigned to a square, a length frequency is accumulated for that square by adding up the samples from the assigned trawl stations.

The area for each square can be easily calculated when the coordinates for its corners are known.

The number of capelin of each length group in the square can be calculated as a product of density and area (A) (adapted from Nakken and Dommasnes, 1977):

$$N_i = (C_I \cdot M) \cdot \frac{p_i}{\sum_{i=1}^n \frac{p_i}{C_{Fi}}} \cdot A \quad (19)$$

N_i = the number of capelin in length group i in the square

C_I = the instrument constant

M = the average integrator value calculated for the square

p_i = the proportion of the capelin in length group i to the total number of capelin in all the length groups ($\sum p_i = 1$)

$C_{Fi} = C_S \cdot l_i^{-b}$ where l_i is the (arithmetic) middle length in the length group i and C_S and b have been determined empirically

A = the area in square nautical miles

The calculations of all N_i for each square are presently done by computer for each half-centimeter length group. The number of capelin in each length group in a larger area or in the total area is found by adding up the number of fish in all squares included in the area. Any area larger than a square is thus defined by the squares in it.

In order to calculate age distribution and biomass it is necessary to make "keys" which give percentage age distribution in each length group. The keys are then applied to the numbers in each length group calculated for the squares, in order to give numbers and biomass in each age group for each square.

Mean length at age and mean weight in each length group can be quite different in different parts of the Barents Sea. For this reason the investigated area is divided into 3-6 subareas in such a way that mean length at age and mean weight at age are reasonably uniform for the trawl stations in that area. The length-age and length-weight keys are then compiled separately for each subarea and applied to all squares in that subarea. The subareas form the basis for compilation of other biological statistics as well.

The total number and biomass of the stock is found by adding the results from all the squares.

3. RESULTS

Figs. 7-19 give the distribution of capelin, both total and by yearclass, together with the survey grids for the period 1972-1984. Fig. 20 gives length distributions, and Tables 1-13 give the acoustic abundance estimates for the same period. Hydrography charts from these cruises for most of the years in question can be found in Loeng (1981), Loeng, Nakken and Raknes (1983) and Gjørseter and Loeng (1984) as well as in the original cruise reports.

4. DISCUSSION

4.1 Distribution

It is seen from Figs. 7-19 that the distribution of capelin has changed from a northern and eastern distribution in the 1970's to a more southern and western distribution in the 1980's. This is a result of well documented changes in the hydrographic conditions in the Barents sea during the period (Loeng 1979, 1983, 1984, and Loeng and Midttun 1984). The relationship between capelin distribution and temperature has been discussed by Loeng (1981), Loeng, Nakken and Raknes (1983) and Gjørseter and Loeng (1984).

Loeng (1981) calculated the area north of 76°N where capelin was found and the area north of 76°N where temperature in 100m depth was above 0°C , using data from the autumn surveys. He found a good correlation between the two. His data also indicated that there was little capelin in areas where the temperature in 100m depth was above 2°C , but that 3 and 4 year old capelin were generally found in somewhat colder water than the younger ones. He found no correlation between ice distribution and capelin distribution.

Loeng, Nakken and Raknes (1983) used data from the autumn surveys to investigate the distribution of capelin in relation to the mean temperature in the depth interval 0-200m. (Table 14). The 2- to 4-year old capelin were found in warmer water in the years 1980-82 than in the period 1974-79, with little difference between the yearclasses. 1-year old capelin were found in somewhat warmer water. They also found that the capelin had a higher growth during the years when they were found in warmer water (Table 15), although the picture was less clear in this case.

Gjørseter and Loeng (1984) continued the work done by Loeng, Nakken and Raknes. They found that the change in capelin distribution during the 1970's was due in particular to a southward displacement of capelin in the area east of 35°E , coinciding with a similar change in the temperature distribution (Fig. 24). A more sophisticated treatment of the temperature/growth data confirmed the findings in the former paper that the growth of the capelin increased during the years when the capelin were in warmer water. Gjørseter and Loeng pointed out that effects linked to the availability of food may be as important in causing this effect as the direct influence of the temperature on growth.

4.2 Acoustic abundance estimates

Dalen et al. (1976) gave the following equation for the target strength of the maximum dorsal aspect for several clupeiform fish including capelin:

$$TS = 19.1 \log l - 64.0 \quad (20)$$

However, during survey conditions the reflection of energy is not necessarily from the maximum dorsal aspect. The aspect angle distribution varies according to the fish behaviour, changing with time (day-night), feeding activity, vertical migration, etc. By combining results from instrument calibrations with the standard sphere, counting measurements and measurements of TS of stunned fish we can get a value for the average target strength or "effective back scattering cross section".

We have

$$\varrho = C \cdot M \quad (1)$$

and

$$C = \frac{C_I}{a} \cdot l^{-b} \quad (7)$$

This gives:

$$\varrho = \frac{C_I}{a} \cdot l^{-b} \cdot M \quad (21)$$

and

$$\varrho = \frac{1}{a} \cdot l^{-b} (C_I \cdot M) \quad (22)$$

On distribution charts the factor $\frac{1}{a} \cdot l^{-b}$ is multiplied by $(C_I \cdot M \cdot 10)$, so

$$\varrho = \frac{1}{10a} \cdot l^{-b} (C_I \cdot M \cdot 10) \quad (23)$$

Using the values from the summer 1983:

$$\varrho = 2.34 \cdot 10^6 \cdot l^{-1.91} (C_I \cdot M \cdot 10) \quad (24)$$

then

$$2.34 \cdot 10^6 \cdot 1^{-1.91} = \frac{1}{10a} \cdot 1^{-b}$$

$$a = 4.27 \cdot 10^{-8}$$

and

$$10 \log a = -73.7 \quad (25)$$

However, as described in the chapter on calibration, the C_v values have changed to a certain degree (text table on page 7). Therefore the value is raised to -74.0 to get an average representative figure of $10 \log a$. Using this value of $10 \log a$ in equation (5) gives:

$$TS = 19.1 \log L - 74.0 \quad (26)$$

This target strength value for capelin, applied in the abundance estimates, is 10 dB lower or 1/10 of the value for maximum dorsal aspect (Fig 23). For herring, Nakken and Olsen (1977) suggested a reduction of 6 dB from maximum to "field" target strength.

It should be kept in mind that this average target strength is a result of different types of measurements. One of these is the C-value obtained from counting single fish traces. But echosounder recordings of capelin can have many different forms - the most common ones are:

- very thin scattering layers where single fish can be distinguished on the recording, often extending from about 20 m to about 80 m.
- denser scattering layers where single fish can be distinguished only in the extreme upper and lower parts of the recording. Density in the middle part of the recording as well as depth and vertical extension can be variable.
- dense "carpets" close to the bottom, often together with polar cod.
- schools, usually very dense, often undertaking diurnal migration to some extent.

Quite often combinations of the above types of recordings are found, with one scattering layer relatively high up in the sea and another scattering layer deeper down, sometimes at the bottom. Under such conditions size distribution in the two layers may be different, usually with larger capelin in the deepest layer. The behaviour of the capelin is thus different in different parts of the distribution area, and the average target strength is also probably different. Recordings of single capelin, the condition in which the target strength applied in abundance estimates is obtained, occur relatively seldom. In addition the survey vessel may influence the behaviour of the capelin.

Olsen et al. (1983) report on investigations of this problem. Fig. 21 gives a summary of the results from their investigations on capelin. The figure shows that integrator values in the depth range 112-132m decreased when the research vessel passed, while the integrator values between 132 and 172m increased. This indicates that the approach and passage of the vessel causes the capelin to swim downwards. One result of this would be that the aspect angle changes during the passage of the vessel, as the capelin are more or less uniformly oriented downwards. This is verified in Fig. 21, which shows that also the sum of the integrator values for the two depth ranges is lower immediately before and during the passage of the vessel.

Aglen (1983b) analyzed the ratios between average values of integrator output obtained during the day and during the night for the years 1974-1978 (Table 16). It is interesting to note that although the ratios vary between 0.7 and 1.4, the mean is 1.0. This may indicate that, on average, the mean target strength for capelin does not change significantly from daytime to nighttime.

Target strength measurements on capelin are scarce. Angell (1983) has measured the target strength of capelin in different densities and tilt angle distributions in net cages (experimental setup described in Olsen et al. 1982 b), and has also estimated target strength by the "echo trace counting method" (Midttun and Nakken, 1971). Fig. 22 gives a short summary of his results. Curve 1 gives the average target strength when the capelin is randomly distributed and orientated within the cage. Here, the mean target strength is approximately the same with changing mean tilt angle. Curve 2 shows the same number of fish when they are systematically oriented (swimming against a current). It is generally acknowledged that fish in schools have a higher degree of orientation than fish in scattered concentrations (Radakov 1973). Thus, curve 2 may be more representative for the target strength of capelin in schools and curve 1 for capelin in a scattering layer. For a mean tilt angle of 0° (i.e. horizontal position) the mean target strength of the capelin in series 2 is considerable higher (5-6 dB) than in series 1. Conversely, for a mean tilt angle of 40° and higher, the target strength of the fish in series 1 are higher. At a mean tilt angle of 0° the spread (or standard deviation) in tilt angle distribution in series 1 (unoriented manner) is greater than in series 2 (orientated manner). The aspect angle which gives maximum reflection is usually in the interval -5° to $+5^{\circ}$ from the horizontal position. In series 2 more fish are within this interval, and as a consequence the mean target strength will be higher.

These experiments indicate that in areas where capelin are schooling, a higher target strength (or lower conversion constant) should be applied. However, schools are generally not suitable for exact abundance estimation with an echo integrator due to acoustic shadowing etc. (Røttingen 1976).

Halldorsson and Røyneisson (1982) carried out in situ measurements of target strength on capelin in sheltered Icelandic waters (Fig. 23). These measurements were completed at night on scattered concentrations, which probably gave recordings comparable to those in the Barents Sea on which the "echo trace counting method" was applied. However, there was some wind (up to 20 knots) when the measurements were carried out, and although the roll or pitch of the ship was not pronounced, the values are possibly somewhat lower than they would have been in calmer seas.

The results of all the above-mentioned target strength experiments are summarized as well in Fig 9. Although some differences may be due to different calibration procedures, it seems that the target strength values applied in the abundance estimates of the Barents Sea capelin are higher than the target strength obtained from Halldorsson and Røynisson (1982) and Angell (1983), with a difference of 2-3 dB. If the values from the measurements by Halldorsson and Røynisson (1982) and Angell (1983) were applied to the stock estimates, this would result in an increase in biomass of 1.5 to 2 times.

4.3 The consistency of the acoustic estimates

A measure of the "goodness" or reliability of the acoustic estimates is the consistency from year to year. This can be investigated in at least two ways:

- By trying to use the estimate from one year to predict the outcome of next year's acoustic survey, taking into account fishing mortality and natural mortality. A good fit between the predicted results and those actually obtained would indicate that the acoustic estimates were reliable.
- By using the acoustic estimates from different years to calculate natural mortality, taking into account the catch. A series of reasonably close values for natural mortality for the the same age group over several years would indicate that the acoustic estimates were reliable.

The last approach was used by Dommasnes (1981), using results from the acoustic surveys in 1975 - 1980. The values of natural mortality obtained were in the range 0.35 - 1.03 for 2 - 3-year-old capelin, 0.37 - 1.80 for 3 - 4-year-old capelin, and 0.01 - 2.66 for 4 - 5-year-olds (Table 17). This did not indicate a particularly high reliability for the acoustic estimates. However, the analysis did not take into account spawning mortality, although it was mentioned as one possible cause of the large variations in natural mortality values that were obtained.

Hamre and Tjelmeland (1981) used the age composition in the catches to calculate the proportion of each age group that spawned. Assuming that all spawning capelin died after spawning, they were able to separate the natural mortality into two independent parameters - one that was due to spawning, and one that was due to "other causes". The latter would be the natural mortality for non-spawners, which they calculated for the years 1970 - 1977 (Table 18). This gave much more consistent results, although the natural mortalities obtained from the 1978- and 1979- cruises were still higher than the rest. Altogether, this indicated a fairly good reliability for the acoustic estimates.

The acoustic surveys from 1980 and later have, however, given rise to more variable results (Tjelmeland, in prep.).

5. REFERENCES

- Aglen, A. 1983a. Random errors of acoustic fish abundance estimates in relation to the survey grid density applied. pp. 293-298 in: Nakken, O. and Venema, S. C. (Eds.). 1983. Symposium on Fisheries Acoustics. Selected papers of the ICES/FAO symposium on Fisheries acoustics. Bergen, Norway, 21-24 June 1982. FAO Fish. Rep., (300): 331 pp.
- Aglen, A. 1983b. Echo integrator threshold and fish density distribution. pp. 35-44 in: Nakken, O. and Venema, S. C. (Eds.). 1983. Symposium on Fisheries Acoustics. Selected papers of the ICES/FAO symposium on Fisheries acoustics. Bergen, Norway, 21-24 June 1982. FAO Fish. Rep., (300): 331 pp.
- Angell, J. 1983. En sammenligning av to uavhengige metoder for beregning av målstyrke og konverteringsfaktorer (C-verdier) for lodde, Mallotus villosus (Müller). Thesis, University of Tromsø, 57 pp. (In Norwegian) [mimeo.]
- Anon. 1980. Report on the Norwegian/USSR acoustic survey of the Barents Sea capelin stock in September/October 1980. 8pp. [mimeo.].
- Anon. 1981. Report on the Norwegian/USSR acoustic survey of the Barents Sea capelin stock in September/October 1981. 19pp. [mimeo.].
- Anon. 1982. Report on the Norwegian/USSR acoustic survey of the Barents Sea capelin stock in September/October 1982. 11pp. [mimeo.].
- Anon. 1983. Report on the Norwegian/USSR acoustic survey of the Barents Sea capelin stock in September 1983. 12pp. [mimeo.].
- Anon. 1984. Report on the Norwegian/USSR acoustic survey of the Barents Sea capelin stock in September 1984. 12pp. [mimeo.].
- Burczynski, J. 1979. Introduction to the use of sonar systems for estimating fish biomass. FAO Fish. Tech. Pap., (191):89 pp.
- Buzeta, R., Dalen, J., Dommasnes, A., Hamre J., and Nakken, O. 1975. Loddeundersøkelser i Barentshavet i september - oktober 1974. Fiskets Gang, 61: 101-104. (In Norwegian)
- Dalen, J. and Nakken, O. 1983. On the application of the echo integration method. Coun. Meet. int. Coun. Explor. Sea 1983 (B:19): 30 pp. [mimeo.]
- Dalen, J., Raknes, A. and Røttingen, I. 1976. Target strength measurements and acoustic biomass estimation of capelin and 0-group fish. Coun. Meet. int. Coun. Explor. Sea 1976 (B:37): 9pp., 2 tabs., 8 figs. [mimeo.]
- Dommasnes, A. 1979. Flowchart for acoustic assessment of one or more species. Acoustic Krill Working Party-News Vol. 1 No. 7 1979. 8pp. [mimeo.].

- Dommasnes, A. 1981. Stock size and mortality estimates for Barents Sea capelin based on acoustic methods. Coun. Meet. Int. Coun. Explor. Sea 1981 (H:45) 7 pp., 4 tabs., 1 fig. [mimeo.]
- Dommasnes, A., Loeng, H. and Monstad, T. 1979. Loddeundersøkelser i Barentshavet høsten 1978. Fisken Hav., 1979 (1): 17-30. (In Norwegian)
- Dommasnes, A., Nakken, O. and Røttingen, I. 1975. Loddeundersøkelser i Barentshavet i september-oktober 1975. Fiskets Gang, 62: 101-108. (In Norwegian)
- Dommasnes, A., Nakken, O., Sætre, R. and Frøiland, Ø. 1974. Loddepolartorskundersøkelser i Barentshavet i september-oktober 1973. Fiskets Gang, 60: 73-77. (In Norwegian)
- Dommasnes, A. and Røttingen, I. 1976. Loddeundersøkelser i Barentshavet i september-oktober 1976. Fisken Hav. 1977 (2):47-59. (In Norwegian)
- Dragesund, O. and Nakken, O. 1972. Lodde- og polartorskundersøkelser i Barentshavet i august-september 1971. Fiskets Gang, 58:145-148. (In Norwegian)
- Fisher, F. H. and Simmonds, V. P. 1977. Sound absorption in sea water. J. Acoust. Soc. Am., 62: 558-564.
- Foote, K. 1981. Absorption term in time-varied-gain functions. FiskDir. Skr. Ser. HavUnders., 17: 191-213.
- Foote, K. 1982. Optimizing copper spheres for precision calibrations with optimal copper spheres. J. Acoust. Soc. Am., 73: 1054-1063.
- Foote, K. G., Knutsen, H. P. and Vestnes, G. 1983. Standard calibration of echo sounders and integrators with optimal copper spheres. FiskDir. Skr. Ser. HavUnders., 17: 335-346.
- Forbes, S. T. and Nakken, O. 1972. Manual of methods for Fisheries resource survey and appraisal. Part 2. The use of acoustic instruments for fish detection and abundance estimation. Food and Agriculture Organization of the United Nations, Rome. 138 pp.
- Gjøvsæter, H. 1984. Standard sampling procedure for Barents Sea capelin. A description of standard sampling technique and methods applied to improve the representativeness of the samples. Contribution to the joint Soviet/Norwegian symposium on Barents Sea capelin, Bergen August 1984. 12pp. + appendix. (Included in this volume)
- Gjøvsæter, H. and Loeng, H. 1984. Distribution and growth of capelin in the Barents Sea in relation to water temperature in the period 1974 to 1983. Coun. Meet. int. Coun. Explor. Sea 1984(Gen:16) 1-15. [mimeo.].
- Gjøvsæter, J., Midttun, L., Monstad, T., Nakken, O., Smedstad, O.M., Sætre, R. and Ulltang, Ø. 1972. Undersøkelser av fiskeforekomster i Barentshavet og ved Spitsbergen i august-september 1972. Fiskets Gang 58: 1010-1021. (In Norwegian)

- Halldorsson, O. and Røyneissson, P. 1982. Target strength measurements of herring and capelin in situ at Iceland. pp. 78-84 in : Nakken, O. and Venema, S. C. (Eds.) 1983. Symposium on Fisheries Acoustics. Selected papers of the ICES/FAO symposium on Fisheries acoustics. Bergen, Norway, 21-24 June 1982. FAO Fish. Rep., (300): 331 pp.
- Hamre, J. and Tjelmeland, S. 1982. Sustainable Yield estimates of the Barents Sea capelin stock. Coun. Meet. int. Coun. Explor. Sea 1982(H:45) 1-24. [mimeo.]
- Johannesson, K. A. and Mitson, R. B. 1983. Fisheries Acoustics. A practical manual for aquatic biomass estimation. FAO Fish. Tech. Pap., (240): 249 pp.
- Knutsen, H. P. 1982. TAF. En spesialkonstruert enhet for kontroll av TVF-funksjonen i forskningsekkolodd. Havforskningsinstituttet, Bergen (In Norwegian) [mimeo.].
- Larsen, R. B. 1984. Escapement of capelin and polar cod through different parts of a pelagic trawl measured during an acoustic survey in the Barents Sea. Report to the Fish Capture Committee, Working Group Meeting, Hirtshals, Denmark April 30-May 4 1984. 11 pp.[mimeo.]
- Loeng, H. 1979. Isforholdene i Barentshavet og vest av Spitsbergen. En oversikt. Fisken Hav., 1979(2): 29-75. (In Norwegian)
- Loeng, H. 1981. Nordlig utbredelse av lodde og temperaturforholdene i Barentshavet om høsten. Fisken Hav., 1981(1): 1-10. (In Norwegian)
- Loeng, H. 1983. Klimavariasjoner i tre hydrografiske snitt i Barentshavet i perioden 1977-1982. Fisken Hav., 1983(3): 5-21. (In Norwegian)
- Loeng, H. 1984. Klimaforholdene i Barentshavet i 1983. Fisken Hav., 1984(1): 9-15. (In Norwegian)
- Loeng, H. and Midttun, L. 1984. Climatic variations in the Barents Sea during the 1970's. Coun. Meet. Int. Coun. Explor. Sea, 1976. (Gen:15) 1-10. [mimeo.].
- Loeng, H., Nakken, O. and Raknes, A. 1983. Loddas utbredelse i Barentshavet i forhold til temperaturfeltet i perioden 1974-1982. Fisken Hav., 1983(1): 1-17. (In Norwegian)
- Mamylov, V. and Dommasnes, A. 1979. Report. Norwegian/USSR acoustic survey of the Barents Sea capelin stock in September 1979. Acoustic estimate. 4 pp. [mimeo.].
- Midttun, L. 1982. Fish and other organisms as acoustic targets. ICES Symp. Fish. Acoust. Bergen, Norway, June 1982, No. 3, 1-126. [mimeo.]
- Midttun, L. and Nakken, O. 1971. On acoustic identification, sizing and abundance estimation of fish. FiskDir. Skr. Ser. HavUnders., 16(1): 36-48.
- Midttun, L. and Nakken, O. 1977. Some results of abundance estimation

- studies with echo integrators. Rapp. P.-v. Reun. Cons. int. Explor. Mer, 170: 253-258.
- Monstad, T. and Røttingen, I. 1977. Loddeundersøkelser i Barentshavet i September-oktober 1977. FiskenHav., 1977 (3): 13-28. (In Norwegian)
- Nakken, O. 1975. On the problem of determining the relationship between integrated echo intensity and fish density. Coun. Meet. Int. Coun. Explor. Sea 1975 (B:26): 7 pp., 1 tab., 1 fig.
- Nakken, O. and Dommasnes, A. 1977. Acoustic estimates of the Barents Sea capelin stock 1971-1976. Coun. Meet. Int. Coun. Explor. Sea 1977 (H:35):1-6, 2 tabs., 3 figs. [mimeo.]
- Nakken, O. and Olsen, K. 1977. Target strength measurements of fish. Rapp. P.-v. Reun. Cons. int. Explor. Mer, 170: 52-69.
- Olsen, K., Angell, J., Pettersen, F. and Løvik, A. 1983. Observed fish reactions to a surveying vessel with special reference to herring, cod, capelin and polar cod. pp. 131-138 in: Nakken, O. and Venema, S. C. (Eds.). Symposium on Fisheries Acoustics. Selected papers of the ICES/FAO symposium on Fisheries acoustics. Bergen, Norway, 21-24 June 1982. FAO Fish. Rep., (300): 331 pp.
- Schulkin, M. and Marsh, H. W. 1962. Sound absorption in sea water. J. Acoust. Soc. Am., 34: 864-865.
- Simmonds, E. J. 1984. The effect of mounting the equivalent beam angle of acoustic survey transducers. Coun. Meet. Int. Coun. Explor. Sea 1984 (B:32): 9 pp. [mimeo.]
- Radakov, D. V. 1973. Schooling in the ecology of fish. John Wiley & Sons. New York. 173 pp.
- Røttingen, I. 1976. On the relation between echo intensity and fish density. Fisk.Dir. Skr. Ser. HavUnders., 16: 301-314.
- Røttingen, I. 1978. Field intercalibrations of echo integrator systems. Coun. Meet. Int. Coun. Explor. Sea 1978 (B:25): 23pp. [mimeo.]
- Tjelmeland, S. (in prep.) Report to the ICES Working Group on Atlanto-Scandian herring and capelin 1985.
- Urick, R. J. 1975. Principles of underwater sound. McGraw Hill, New York. 384 pp. 2nd ed.

Table 1. Acoustic abundance estimate of capelin, autumn 1972.

| LENGDE | Alder | | | | | TOT | VEKT | GJ.VOL | KOND. |
|---------|--------|--------|--------|-------|-------|--------|-------|--------|-------|
| | 1 | 2 | 3 | 4 | 5+ | | | | |
| 30-35 | | | | | | 2 | 0.0 | 0.1 | 2.9 |
| 35-40 | | | | | | 5 | 0.0 | 0.2 | 3.8 |
| 40-45 | | | | | | 15 | 0.0 | 0.3 | 3.9 |
| 45-50 | | | | | | 27 | 0.1 | 0.4 | 3.7 |
| 50-55 | | | | | | 49 | 0.2 | 0.5 | 3.5 |
| 55-60 | | | | | | 123 | 0.7 | 0.6 | 3.2 |
| 60-65 | 215 | | | | | 215 | 1.5 | 0.7 | 2.9 |
| 65-70 | 506 | | | | | 506 | 4.9 | 1.0 | 3.3 |
| 70-75 | 1186 | | | | | 1186 | 13.8 | 1.2 | 3.1 |
| 75-80 | 2655 | | | | | 2655 | 43.8 | 1.7 | 3.7 |
| 80-85 | 3281 | | | | | 3281 | 70.0 | 2.2 | 3.9 |
| 85-90 | 3165 | | | | | 3165 | 92.1 | 3.0 | 4.5 |
| 90-95 | 2164 | | | | | 2164 | 63.0 | 3.0 | 3.8 |
| 95-100 | 1210 | | | | | 1210 | 46.9 | 4.0 | 4.3 |
| 100-105 | 610 | | | | | 610 | 22.5 | 3.8 | 3.5 |
| 105-110 | 181 | 109 | | | | 282 | 12.4 | 4.5 | 3.6 |
| 110-115 | | 204 | | | | 204 | 10.8 | 5.4 | 3.8 |
| 115-120 | | 445 | 20 | | | 461 | 28.2 | 6.3 | 3.9 |
| 120-125 | | 1435 | 39 | | | 1471 | 106.8 | 7.5 | 4.1 |
| 125-130 | | 3151 | 465 | 43 | | 3660 | 291.0 | 8.2 | 4.0 |
| 130-135 | | 3880 | 2109 | 64 | | 6053 | 550.6 | 9.4 | 4.0 |
| 135-140 | | 2908 | 3395 | 172 | | 6476 | 669.9 | 10.7 | 4.1 |
| 140-145 | | 1183 | 4083 | 165 | | 5435 | 618.1 | 11.7 | 4.1 |
| 145-150 | | 464 | 2759 | 290 | | 3511 | 449.5 | 13.2 | 4.1 |
| 150-155 | | 249 | 1703 | 232 | 18 | 2210 | 311.7 | 14.5 | 4.1 |
| 155-160 | | 62 | 1021 | 281 | 15 | 1396 | 214.7 | 15.9 | 4.1 |
| 160-165 | | 40 | 622 | 320 | 43 | 1029 | 186.4 | 18.7 | 4.4 |
| 165-170 | | | 399 | 335 | 25 | 760 | 144.4 | 19.6 | 4.2 |
| 170-175 | | | 199 | 233 | 23 | 451 | 99.8 | 22.8 | 4.4 |
| 175-180 | | | 85 | 82 | 26 | 196 | 43.3 | 22.8 | 4.1 |
| 180-185 | | | 39 | 64 | 8 | 115 | 30.4 | 27.3 | 4.5 |
| 185-190 | | | | 6 | 6 | 10 | 2.7 | 27.5 | 4.2 |
| 190-195 | | | | | 22 | 22 | 6.0 | 28.0 | 3.9 |
| 195-200 | | | | | | 0 | 0.0 | 0.0 | 0.0 |
| 200-205 | | | | | | 0 | 0.0 | 0.0 | 0.0 |
| 205-210 | | | | | 7 | 7 | 2.0 | 30.0 | 3.4 |
| ANTALL: | 15173. | 14130. | 16938. | 2287. | 193. | 48962. | | | |
| GJ.LGD: | 8.48 | 13.23 | 14.44 | 15.71 | 17.17 | 12.28 | | | |
| VEKT: | 366.2 | 1281.6 | 2074.4 | 373.3 | 40.7 | 4138.3 | | | |
| GJ.VOL: | 2.5 | 9.4 | 12.6 | 16.8 | 21.7 | 8.7 | | | |
| KOND.: | 3.9 | 4.0 | 4.1 | 4.2 | 4.3 | 4.0 | | | |

Alder = age
 Antall = number $\times 10^{-7}$
 Gj.lgd. = mean length (cm)
 Volum = biomass hectolitres $\times 10^{-3}$
 Gj.vol = mean volume per individual (ml)
 Vekt = biomass tonnes $\times 10^3$
 Kond. = condition factor ($1000 \times \text{mean volume}/\text{length}^3$)
 Lengde = length group (mm)

Table 2. Acoustic abundance estimate of capelin, autumn 1973.

| LENGDE | Alder | | | | | TOT | VOLUM | GJ.VOL. | KONDI. |
|----------|--------|--------|-------|-------|-------|---------|-------|---------|--------|
| | 1 | 2 | 3 | 4 | 5+ | | | | |
| 35- 40 | 7 | | | | | 7 | 0. | 0.3 | 5.7 |
| 40- 45 | 133 | | | | | 133 | 5. | 0.4 | 5.2 |
| 45- 50 | 819 | | | | | 819 | 41. | 0.5 | 4.7 |
| 50- 55 | 865 | | | | | 865 | 52. | 0.6 | 4.1 |
| 55- 60 | 836 | | | | | 836 | 59. | 0.7 | 3.7 |
| 60- 65 | 488 | 69 | | | | 557 | 45. | 0.8 | 3.3 |
| 65- 70 | 613 | | | | | 613 | 61. | 1.0 | 3.3 |
| 70- 75 | 952 | 182 | | | | 1134 | 155. | 1.2 | 3.1 |
| 75- 80 | 1142 | | | | | 1142 | 186. | 1.3 | 2.8 |
| 80- 85 | 3048 | 131 | | | | 3179 | 636. | 2.0 | 3.6 |
| 85- 90 | 7240 | 219 | | | | 7459 | 1638. | 2.2 | 3.3 |
| 90- 95 | 12053 | 1489 | | | | 13542 | 3791. | 2.9 | 3.7 |
| 95-100 | 12960 | 3454 | | | | 16416 | 5135. | 3.1 | 3.3 |
| 100-105 | 8195 | 6267 | | | | 14462 | 5570. | 3.7 | 3.4 |
| 105-110 | 4931 | 5307 | | | | 10241 | 4676. | 4.5 | 3.6 |
| 110-115 | 2493 | 5065 | | | | 7578 | 4149. | 5.0 | 3.5 |
| 115-120 | 860 | 4511 | 52 | | | 5425 | 3472. | 6.4 | 3.9 |
| 120-125 | 240 | 4194 | | | | 4429 | 3293. | 6.7 | 3.6 |
| 125-130 | 234 | 2456 | 40 | | | 2741 | 2380. | 8.1 | 3.9 |
| 130-135 | 66 | 1738 | 132 | | | 1938 | 1943. | 9.5 | 4.1 |
| 135-140 | 21 | 1271 | 263 | | | 1554 | 1781. | 10.6 | 4.1 |
| 140-145 | 30 | 691 | 306 | 23 | | 1053 | 1322. | 12.5 | 4.3 |
| 145-150 | | 310 | 579 | 45 | | 938 | 1336. | 13.8 | 4.3 |
| 150-155 | | 211 | 648 | 145 | | 1009 | 1616. | 16.1 | 4.5 |
| 155-160 | | 210 | 557 | 205 | | 971 | 1829. | 18.8 | 4.8 |
| 160-165 | | 34 | 570 | 359 | | 963 | 2011. | 20.2 | 4.7 |
| 165-170 | | 26 | 574 | 298 | 5 | 907 | 2162. | 23.5 | 5.0 |
| 170-175 | | 37 | 299 | 292 | 6 | 630 | 1613. | 25.3 | 4.9 |
| 175-180 | | | 116 | 250 | 9 | 375 | 1143. | 29.1 | 5.2 |
| 180-185 | | | 72 | 140 | | 212 | 681. | 31.5 | 5.2 |
| 185-190 | | | | 30 | | 30 | 110. | 33.0 | 5.0 |
| 190-195 | | | | 3 | | 3 | 11. | 38.0 | 5.3 |
| 195-200 | | | | 2 | | 2 | 11. | 45.0 | 5.8 |
| ANTALL: | 58226. | 37892. | 4208. | 1792. | 20. | 102163. | | | |
| GJ.LGD: | 9.37 | 11.33 | 15.55 | 16.71 | 17.35 | 10.49 | | | |
| VOLUM : | 17846. | 23023. | 7669. | 4253. | 60. | 52915. | | | |
| GJ.VOL: | 3.0 | 5.6 | 18.6 | 23.3 | 0.0 | 5.0 | | | |
| KONDI. : | 3.5 | 3.6 | 4.7 | 4.9 | 0.0 | 3.6 | | | |

Legend as in Table 1.

Table 3. Acoustic abundance estimate of capelin, autumn 1974.

| LENGTH | Alder | | | | | TOT | VOLUM | G.J.VOL | KOND. |
|---------|--------|--------|--------|-------|-------|-----------|-------|---------|-------|
| | 1 | 2 | 3 | 4 | 5+ | | | | |
| 50- 55 | | | | | | 1 | 0. | 0.6 | 4.1 |
| 55- 60 | 14 | | | | | 14 | 1. | 0.7 | 3.7 |
| 60- 65 | 36 | | | | | 36 | 3. | 0.8 | 3.3 |
| 65- 70 | 53 | | | | | 53 | 5. | 1.0 | 3.3 |
| 70- 75 | 233 | 11 | | | | 244 | 29. | 1.2 | 3.1 |
| 75- 80 | 397 | 5 | | | | 402 | 56. | 1.4 | 3.0 |
| 80- 85 | 1108 | 100 | 6 | | | 1217 | 233. | 1.9 | 3.4 |
| 85- 90 | 2493 | 115 | | | | 2606 | 574. | 2.2 | 3.3 |
| 90- 95 | 3727 | 460 | 29 | | | 4218 | 1182. | 2.8 | 3.5 |
| 95-100 | 7021 | 1812 | 134 | | | 8964 | 2787. | 3.1 | 3.3 |
| 100-105 | 7837 | 8245 | 880 | | | 16958 | 6424. | 3.7 | 3.4 |
| 105-110 | 6180 | 11940 | 1595 | | | 19716 | 8319. | 4.2 | 3.4 |
| 110-115 | 2599 | 10757 | 2168 | | | 15532 | 7732. | 5.0 | 3.5 |
| 115-120 | 571 | 8504 | 2157 | | | 11233 | 6399. | 5.8 | 3.6 |
| 120-125 | 162 | 6253 | 2107 | | | 8521 | 5752. | 6.9 | 3.8 |
| 125-130 | 30 | 3650 | 1541 | 10 | | 5232 | 4108. | 7.9 | 3.8 |
| 130-135 | 10 | 1997 | 1616 | 25 | | 3655 | 3341. | 9.2 | 4.0 |
| 135-140 | | 1041 | 1503 | 5 | | 2551 | 2712. | 10.4 | 4.0 |
| 140-145 | | 859 | 1292 | 42 | | 2195 | 2708. | 12.1 | 4.2 |
| 145-150 | | 402 | 1071 | 13 | | 1485 | 2099. | 13.9 | 4.3 |
| 150-155 | | 207 | 646 | 36 | | 869 | 1442. | 15.6 | 4.4 |
| 155-160 | | 60 | 541 | 17 | | 615 | 1149. | 18.1 | 4.6 |
| 160-165 | | 24 | 311 | 62 | | 398 | 848. | 20.8 | 4.8 |
| 165-170 | | 1 | 167 | 42 | | 212 | 507. | 23.6 | 5.0 |
| 170-175 | | 6 | 86 | 51 | 7 | 145 | 364. | 24.3 | 4.7 |
| 175-180 | | | 20 | 24 | | 37 | 104. | 27.0 | 4.8 |
| 180-185 | | | 21 | 15 | | 29 | 95. | 32.0 | 5.3 |
| 185-190 | | | 25 | | | 25 | 81. | 32.0 | 4.9 |
| 190-195 | | | 9 | 9 | | 15 | 58. | 0.0 | 0.0 |
| 195-200 | | | | 5 | | 5 | 21. | 0.0 | 0.0 |
| ANTALL: | 32471. | 56449. | 17925. | 356. | | 7.107203. | | | |
| GJ.LGD: | 9.99 | 11.42 | 12.74 | 16.00 | 17.25 | 11.22 | | | |
| VOLUM : | 11206. | 31253. | 15872. | 736. | 18. | 59135. | | | |
| GJ.VOL: | 3.4 | 5.6 | 9.1 | 21.2 | 0.0 | 5.5 | | | |
| KOND. : | 3.3 | 3.7 | 3.9 | 4.8 | 0.0 | 3.6 | | | |

Legend as in Table 1.

Table 4. Acoustic abundance estimate of capelin, autumn 1975.

| LENGDE | Alder | | | | | TOT | VOLUM | GJ.VOL | KOND. |
|---------|--------|--------|--------|--------|-------|--------|-------|--------|-------|
| | 1 | 2 | 3 | 4 | 5+ | | | | |
| 55- 60 | 25 | | | | | 25 | 1. | 0.0 | 0.0 |
| 60- 65 | 7 | | | | | 7 | 0. | 0.5 | 2.0 |
| 65- 70 | 7 | | | | | 7 | 0. | 0.7 | 2.3 |
| 70- 75 | 19 | | | | | 19 | 2. | 1.0 | 2.6 |
| 75- 80 | 158 | | | | | 158 | 19. | 1.5 | 3.2 |
| 80- 85 | 460 | 45 | | | | 505 | 89. | 2.0 | 3.6 |
| 85- 90 | 1848 | 21 | | | | 1869 | 386. | 3.0 | 4.5 |
| 90- 95 | 4049 | 285 | | | | 4334 | 1140. | 3.0 | 3.8 |
| 95-100 | 4483 | 806 | | | | 5289 | 1668. | 3.3 | 3.6 |
| 100-105 | 4975 | 1305 | | | | 6278 | 2429. | 4.1 | 3.8 |
| 105-110 | 2549 | 3439 | 33 | | | 6022 | 2652. | 4.6 | 3.7 |
| 110-115 | 1008 | 5254 | 1041 | 41 | | 7347 | 3854. | 5.3 | 3.7 |
| 115-120 | 320 | 8223 | 3084 | 88 | 12 | 11727 | 6922. | 5.7 | 3.5 |
| 120-125 | 82 | 6435 | 4085 | 292 | | 10909 | 7730. | 6.9 | 3.8 |
| 125-130 | | 4455 | 5402 | 503 | 35 | 10388 | 8808. | 8.1 | 3.9 |
| 130-135 | | 2696 | 4397 | 855 | | 7956 | 7889. | 9.0 | 3.9 |
| 135-140 | | 1655 | 3553 | 742 | | 5943 | 6716. | 11.1 | 4.3 |
| 140-145 | | 681 | 2724 | 984 | | 4393 | 5625. | 12.3 | 4.3 |
| 145-150 | | 241 | 1920 | 906 | | 3063 | 4560. | 14.3 | 4.5 |
| 150-155 | | 269 | 1564 | 583 | | 2412 | 3891. | 16.2 | 4.6 |
| 155-160 | | 150 | 902 | 1069 | 18 | 2145 | 4001. | 18.7 | 4.8 |
| 160-165 | | 108 | 681 | 841 | | 1627 | 3438. | 20.1 | 4.7 |
| 165-170 | | | 530 | 636 | | 1164 | 2819. | 22.6 | 4.8 |
| 170-175 | | | 224 | 569 | 32 | 826 | 2323. | 24.3 | 4.7 |
| 175-180 | | | 148 | 464 | | 610 | 1837. | 30.0 | 5.4 |
| 180-185 | | | 111 | 157 | | 265 | 917. | 31.0 | 5.1 |
| 185-190 | | | 7 | 59 | | 66 | 238. | 0.0 | 0.0 |
| ANTALL: | 19990. | 36068. | 30406. | 8789. | 97. | 95353. | | | |
| GJ.LGD: | 9.87 | 12.00 | 13.42 | 15.07 | 14.67 | 12.29 | | | |
| VOLUM : | 6724. | 24649. | 33445. | 15060. | 131. | 79955. | | | |
| GJ.VOL: | 3.7 | 6.8 | 10.4 | 16.0 | 19.0 | 8.1 | | | |
| KOND. : | 3.8 | 3.7 | 4.1 | 4.5 | 4.9 | 3.9 | | | |

Legend as in Table 1.

Table 5. Acoustic abundance estimate of capelin, autumn 1976.

| Alder | | | | | | | | | |
|---------|--------|--------|--------|--------|-------|--------|-------|---------|-------|
| LENGDE | 1 | 2 | 3 | 4 | 5+ | TOT | VOLUM | GJ.VOL. | KOND. |
| 45- 50 | 31 | | | | | 31 | 2. | 0.0 | 0.0 |
| 50- 55 | 31 | | | | | 31 | 2. | 0.0 | 0.0 |
| 55- 60 | 124 | | | | | 124 | 9. | 0.0 | 0.0 |
| 60- 65 | 437 | | | | | 437 | 35. | 0.0 | 0.0 |
| 65- 70 | 124 | | | | | 124 | 11. | 0.0 | 0.0 |
| 70- 75 | 24 | | | | | 24 | 2. | 0.0 | 0.0 |
| 75- 80 | 304 | | | | | 304 | 36. | 0.0 | 0.0 |
| 80- 85 | 965 | | | | | 965 | 135. | 0.0 | 0.0 |
| 85- 90 | 1542 | 27 | | | | 1569 | 251. | 0.0 | 0.0 |
| 90- 95 | 2191 | 11 | | | | 2202 | 527. | 2.0 | 2.5 |
| 95-100 | 2651 | | 12 | | | 2663 | 778. | 2.5 | 2.7 |
| 100-105 | 5239 | 74 | | | | 5308 | 1941. | 3.5 | 3.3 |
| 105-110 | 4592 | 287 | 53 | | | 4927 | 2091. | 4.5 | 3.6 |
| 110-115 | 2966 | 1394 | 58 | | | 4412 | 2249. | 5.3 | 3.7 |
| 115-120 | 1216 | 3947 | 497 | 57 | | 5734 | 3496. | 6.0 | 3.7 |
| 120-125 | 246 | 5093 | 1117 | 132 | | 6591 | 4527. | 7.1 | 3.9 |
| 125-130 | 36 | 4687 | 2015 | 325 | 27 | 7096 | 5609. | 8.1 | 3.9 |
| 130-135 | | 3183 | 1983 | 436 | 48 | 5656 | 5216. | 9.1 | 3.9 |
| 135-140 | | 2583 | 2349 | 801 | 6 | 5735 | 6135. | 10.5 | 4.0 |
| 140-145 | | 1543 | 2034 | 790 | 141 | 4505 | 5570. | 11.9 | 4.1 |
| 145-150 | | 844 | 2303 | 996 | 119 | 4250 | 5993. | 13.5 | 4.2 |
| 150-155 | | 257 | 1544 | 1022 | 129 | 2960 | 4796. | 15.6 | 4.4 |
| 155-160 | | 100 | 1365 | 851 | 254 | 2588 | 4689. | 17.4 | 4.5 |
| 160-165 | | 24 | 515 | 656 | 99 | 1296 | 2728. | 19.6 | 4.6 |
| 165-170 | | 16 | 412 | 519 | 56 | 1005 | 2411. | 22.4 | 4.8 |
| 170-175 | | | 311 | 544 | 108 | 965 | 2566. | 24.3 | 4.7 |
| 175-180 | | | 142 | 343 | 87 | 563 | 1710. | 28.6 | 5.1 |
| 180-185 | | | 5 | 256 | 113 | 368 | 1252. | 29.3 | 4.8 |
| 185-190 | | | 18 | 82 | 24 | 123 | 482. | 40.0 | 6.1 |
| 190-195 | | | | 30 | 56 | 86 | 357. | 42.0 | 5.9 |
| 200-205 | | | | 4 | | 4 | 22. | 0.0 | 0.0 |
| ANTALL: | 22719. | 24070. | 16733. | 7844. | 1267. | 72646. | | | |
| GJ.LGD: | 10.07 | 12.74 | 14.15 | 15.28 | 16.05 | 12.56 | | | |
| VOLUM : | 8049. | 19752. | 21325. | 13753. | 2756. | 65628. | | | |
| GJ.VOL: | 3.9 | 8.2 | 12.4 | 16.4 | 18.2 | 9.2 | | | |
| KOND. : | 3.3 | 3.9 | 4.2 | 4.4 | 4.5 | 3.9 | | | |

Legend as in Table 1.

Table 6. Acoustic abundance estimate of capelin, autumn 1977.

| Alder | | | | | | | | | |
|---------|--------|--------|--------|-------|-------|--------|-------|--------|-------|
| LENGDE | 1 | 2 | 3 | 4 | 5+ | TOT | VOLUM | GJ.VOL | KOND. |
| 40- 45 | | | | | | 297 | 6. | 0.2 | 2.6 |
| 45- 50 | | | | | | 739 | 15. | 0.2 | 1.9 |
| 50- 55 | 483 | | | | | 483 | 14. | 0.3 | 2.1 |
| 55- 60 | 916 | | | | | 916 | 37. | 0.4 | 2.1 |
| 60- 65 | 1926 | | | | | 1926 | 96. | 0.5 | 2.0 |
| 65- 70 | 2620 | | | | | 2620 | 157. | 0.6 | 2.0 |
| 70- 75 | 4027 | | | | | 4027 | 282. | 0.7 | 1.8 |
| 75- 80 | 4046 | | | | | 4046 | 485. | 1.2 | 2.6 |
| 80- 85 | 5701 | 2 | | | | 5703 | 1063. | 1.9 | 3.3 |
| 85- 90 | 5441 | 55 | | | | 5496 | 1222. | 2.2 | 3.3 |
| 90- 95 | 4313 | 155 | | | | 4468 | 1253. | 2.8 | 3.5 |
| 95-100 | 4052 | 247 | | | | 4299 | 1361. | 3.2 | 3.4 |
| 100-105 | 2716 | 421 | 2 | | | 3139 | 1178. | 3.8 | 3.5 |
| 105-110 | 1058 | 775 | 2 | | | 1834 | 789. | 4.3 | 3.5 |
| 110-115 | 330 | 1945 | 12 | | | 2285 | 1156. | 5.1 | 3.6 |
| 115-120 | 73 | 2970 | 42 | 18 | | 3111 | 1842. | 5.9 | 3.7 |
| 120-125 | 6 | 3250 | 202 | 30 | | 3488 | 2466. | 7.1 | 3.8 |
| 125-130 | | 2508 | 419 | 40 | | 2971 | 2426. | 8.2 | 3.9 |
| 130-135 | | 2360 | 800 | 128 | | 3287 | 3207. | 9.8 | 4.2 |
| 135-140 | | 1295 | 1154 | 212 | | 2669 | 2996. | 11.2 | 4.3 |
| 140-145 | | 869 | 1204 | 298 | 33 | 2410 | 3144. | 13.0 | 4.5 |
| 145-150 | | 558 | 1406 | 449 | 26 | 2442 | 3637. | 14.9 | 4.6 |
| 150-155 | | 344 | 1115 | 463 | 85 | 2012 | 3432. | 17.1 | 4.8 |
| 155-160 | | 236 | 1364 | 559 | 135 | 2292 | 4379. | 19.1 | 4.9 |
| 160-165 | | 94 | 870 | 486 | 98 | 1555 | 3425. | 22.0 | 5.1 |
| 165-170 | | 18 | 844 | 372 | 89 | 1324 | 3231. | 24.4 | 5.2 |
| 170-175 | | 13 | 367 | 489 | 113 | 983 | 2726. | 27.7 | 5.4 |
| 175-180 | | | 253 | 347 | 145 | 746 | 2273. | 30.5 | 5.4 |
| 180-185 | | | 101 | 173 | 14 | 286 | 949. | 33.2 | 5.5 |
| 185-190 | | | 14 | 69 | 5 | 88 | 309. | 35.1 | 5.3 |
| 190-195 | | | | 20 | | 20 | 84. | 42.0 | 5.9 |
| 195-200 | | | | 6 | | 6 | 29. | 48.0 | 6.2 |
| ANTALL: | 37708. | 18115. | 10171. | 4159. | 743. | 71968. | | | |
| GJ.LGD: | 8.38 | 12.49 | 15.00 | 15.90 | 16.46 | 10.82 | | | |
| VOLUM : | 7515. | 14648. | 17074. | 8683. | 1706. | 49669. | | | |
| GJ.VOL: | 2.0 | 8.1 | 16.8 | 20.9 | 23.0 | 6.9 | | | |
| KOND. : | 2.9 | 3.9 | 4.8 | 5.0 | 5.1 | 3.6 | | | |

Legend as in Table 1.

Table 7. Acoustic abundance estimate of capelin, autumn 1978.

| Alder | | | | | | | | | |
|---------|--------|--------|--------|-------|-------|--------|-------|---------|-------|
| LENGDE | 1 | 2 | 3 | 4 | 5+ | TOT | VOLUM | GJ.VOL. | KOND. |
| 35-40 | | | | | | 23 | 0. | 0.2 | 3.8 |
| 40-45 | | | | | | 47 | 1. | 0.3 | 3.9 |
| 45-50 | | | | | | 117 | 6. | 0.5 | 4.7 |
| 50-55 | | | | | | 159 | 11. | 0.7 | 4.8 |
| 55-60 | | | | | | 67 | 6. | 0.9 | 4.7 |
| 60-65 | | | | | | 5 | 1. | 1.1 | 4.5 |
| 65-70 | | 2 | | | | 53 | 7. | 1.4 | 4.5 |
| 70-75 | 694 | 6 | | | | 700 | 118. | 1.7 | 4.4 |
| 75-80 | 484 | 8 | | | | 492 | 97. | 2.0 | 4.2 |
| 80-85 | 1042 | 42 | | | | 1084 | 247. | 2.3 | 4.1 |
| 85-90 | 987 | 98 | | | | 1085 | 267. | 2.5 | 3.7 |
| 90-95 | 2970 | 385 | | | | 3355 | 857. | 2.6 | 3.2 |
| 95-100 | 3270 | 996 | | | | 4266 | 1342. | 3.1 | 3.4 |
| 100-105 | 1079 | 3426 | | | | 4506 | 1776. | 3.9 | 3.7 |
| 105-110 | 308 | 4745 | | | | 5052 | 2278. | 4.5 | 3.6 |
| 110-115 | 169 | 5961 | 32 | | | 6162 | 3224. | 5.2 | 3.7 |
| 115-120 | | 5871 | 44 | | | 5915 | 3545. | 6.0 | 3.7 |
| 120-125 | | 5952 | 63 | | | 6015 | 4286. | 7.1 | 3.9 |
| 125-130 | | 3735 | 193 | | | 3928 | 3262. | 8.3 | 4.0 |
| 130-135 | | 2584 | 819 | | | 3402 | 3333. | 9.8 | 4.2 |
| 135-140 | | 1483 | 1085 | | | 2568 | 2810. | 10.9 | 4.2 |
| 140-145 | | 723 | 1331 | 41 | | 2097 | 2742. | 13.1 | 4.5 |
| 145-150 | | 540 | 1420 | 101 | 12 | 2082 | 3044. | 14.6 | 4.6 |
| 150-155 | | 237 | 1669 | 142 | | 2049 | 3442. | 16.8 | 4.7 |
| 155-160 | | 159 | 1118 | 315 | | 1600 | 3090. | 19.3 | 4.9 |
| 160-165 | | 78 | 1014 | 312 | 28 | 1441 | 3091. | 21.4 | 5.0 |
| 165-170 | | 57 | 552 | 264 | 17 | 890 | 2085. | 23.4 | 5.0 |
| 170-175 | | | 292 | 156 | 3 | 451 | 1215. | 26.9 | 5.2 |
| 175-180 | | 3 | 193 | 49 | 3 | 252 | 772. | 30.6 | 5.5 |
| 180-185 | | | 108 | 42 | | 150 | 499. | 33.3 | 5.5 |
| 185-190 | | | 19 | 5 | 8 | 32 | 132. | 41.3 | 6.3 |
| 190-195 | | | 6 | | | 6 | 22. | 36.0 | 5.0 |
| ANTALL: | 11003. | 37091. | 9958. | 1427. | 71. | 60051. | | | |
| GJ.LGD: | 9.24 | 11.82 | 15.01 | 16.20 | 16.50 | 11.94 | | | |
| VOLUM: | 3103. | 24875. | 16469. | 2948. | 164. | 47609. | | | |
| GJ.VOL: | 2.8 | 6.7 | 16.5 | 20.7 | 23.1 | 7.9 | | | |
| KOND.: | 3.6 | 3.8 | 4.7 | 4.8 | 5.0 | 4.0 | | | |

Legend as in Table 1.

Table 8. Acoustic abundance estimate of capelin, autumn 1979.

| Alder | | | | | | | | | |
|---------|-------|--------|--------|-------|-------|--------|-------|--------|-------|
| LENGDE | 1 | 2 | 3 | 4 | 5+ | TOT | VENT | GJ.VOL | KOND. |
| 40- 45 | | | | | | 6 | 0.0 | 0.2 | 2.6 |
| 45- 50 | | | | | | 326 | 1.0 | 0.3 | 2.8 |
| 50- 55 | | | | | | 724 | 2.9 | 0.4 | 2.8 |
| 55- 60 | | | | | | 583 | 2.9 | 0.5 | 2.6 |
| 60- 65 | 77 | | | | | 77 | 0.5 | 0.7 | 2.9 |
| 65- 70 | 77 | | | | | 77 | 0.7 | 0.9 | 2.9 |
| 70- 75 | | | | | | 0 | 0.0 | 0.0 | 0.0 |
| 75- 80 | | | | | | 0 | 0.0 | 0.0 | 0.0 |
| 80- 85 | 13 | | | | | 13 | 0.2 | 1.8 | 3.2 |
| 85- 90 | 6 | | | | | 6 | 0.1 | 2.2 | 3.3 |
| 90- 95 | 38 | | | | | 38 | 1.1 | 3.0 | 3.8 |
| 95-100 | 134 | 79 | | | | 209 | 7.1 | 3.4 | 3.7 |
| 100-105 | 325 | 464 | | | | 789 | 33.9 | 4.3 | 4.0 |
| 105-110 | 373 | 1623 | | | | 1682 | 75.7 | 4.5 | 3.6 |
| 110-115 | 215 | 2935 | | | | 3145 | 165.4 | 5.3 | 3.7 |
| 115-120 | 183 | 6697 | 140 | | | 7023 | 427.1 | 6.1 | 3.7 |
| 120-125 | 31 | 8438 | 114 | | | 8583 | 612.0 | 7.1 | 3.9 |
| 125-130 | | 6522 | 1048 | | | 7570 | 618.4 | 8.2 | 3.9 |
| 130-135 | | 3944 | 2293 | | | 6230 | 589.5 | 9.5 | 4.1 |
| 135-140 | | 1897 | 1683 | 39 | | 3620 | 399.7 | 11.0 | 4.2 |
| 140-145 | | 576 | 1695 | 12 | | 2271 | 292.4 | 12.9 | 4.5 |
| 145-150 | | 111 | 1441 | 48 | | 1598 | 238.9 | 15.0 | 4.7 |
| 150-155 | | 54 | 1228 | 89 | | 1376 | 234.0 | 17.0 | 4.8 |
| 155-160 | | 52 | 629 | 33 | | 706 | 137.2 | 19.4 | 5.0 |
| 160-165 | | 9 | 580 | 82 | | 672 | 143.4 | 21.3 | 5.0 |
| 165-170 | | | 165 | 49 | 2 | 219 | 52.7 | 24.0 | 5.1 |
| 170-175 | | | 170 | 76 | | 245 | 67.1 | 27.4 | 5.3 |
| 175-180 | | | 55 | 44 | | 99 | 31.9 | 32.3 | 5.8 |
| 180-185 | | | 8 | 6 | | 14 | 4.8 | 34.6 | 5.7 |
| ANTALL: | 1472. | 33403. | 11249. | 478. | 2. | 47901. | | | |
| GJ.LGD: | 10.26 | 12.31 | 14.24 | 16.00 | 16.75 | 12.51 | | | |
| VENT : | 60.6 | 2468.3 | 1516.0 | 100.8 | 0.5 | 4140.9 | | | |
| GJ.VOL: | 4.1 | 7.4 | 13.5 | 21.1 | 27.0 | 8.6 | | | |
| KOND. : | 3.6 | 3.9 | 4.5 | 5.0 | 5.7 | 4.0 | | | |

Legend as in Table 1.

Table 9. Acoustic abundance estimate of capelin, autumn 1980.

| Alder | | | | | | | | | |
|-----------|--------------------|-------|-------|--------|-------|-------|-------|--------|-------|
| LENGDE | 1 | 2 | 3 | 4 | 5 | TOT | VEKT | GJ.VOL | KOND. |
| 6.5- 6.9 | 63 | | | | | 63 | 0.6 | 1.0 | 3.3 |
| 7.0- 7.4 | 260 | | | | | 260 | 2.6 | 1.0 | 2.6 |
| 7.5- 7.9 | 272 | | | | | 272 | 2.7 | 1.0 | 2.1 |
| 8.0- 8.4 | 534 | | | | | 534 | 9.1 | 1.7 | 3.0 |
| 8.5- 8.9 | 1455 | | | | | 1455 | 29.1 | 2.0 | 3.0 |
| 9.0- 9.4 | 2490 | | | | | 2490 | 58.7 | 2.4 | 3.0 |
| 9.5- 9.9 | 2633 | 25 | | | | 2658 | 81.5 | 3.1 | 3.3 |
| 10.0-10.4 | 2968 | 75 | | | | 3043 | 120.4 | 4.0 | 3.7 |
| 10.5-10.9 | 5275 | 388 | | | | 5663 | 264.5 | 4.7 | 3.8 |
| 11.0-11.4 | 5874 | 1146 | 13 | | | 7033 | 372.0 | 5.3 | 3.7 |
| 11.5-11.9 | 3146 | 2463 | 4 | | | 5613 | 347.8 | 6.2 | 3.8 |
| 12.0-12.4 | 1221 | 3386 | 52 | | | 4659 | 344.3 | 7.4 | 4.0 |
| 12.5-12.9 | 593 | 3185 | 168 | 4 | | 3950 | 343.0 | 8.7 | 4.2 |
| 13.0-13.4 | 256 | 3108 | 459 | 14 | | 3837 | 390.1 | 10.2 | 4.4 |
| 13.5-13.9 | 59 | 2724 | 1131 | 14 | | 3928 | 452.5 | 11.5 | 4.4 |
| 14.0-14.4 | | 1836 | 2317 | 108 | | 4261 | 561.5 | 13.2 | 4.6 |
| 14.5-14.9 | | 756 | 2811 | 197 | | 3764 | 554.8 | 14.7 | 4.6 |
| 15.0-15.4 | | 422 | 2776 | 381 | | 3579 | 604.5 | 16.9 | 4.8 |
| 15.5-15.9 | | 92 | 1800 | 464 | 1 | 2357 | 447.6 | 19.0 | 4.9 |
| 16.0-16.4 | | 43 | 1453 | 469 | 29 | 1994 | 437.3 | 21.9 | 5.1 |
| 16.5-16.9 | | 7 | 878 | 410 | | 1295 | 327.2 | 25.3 | 5.4 |
| 17.0-17.4 | | 7 | 510 | 384 | | 901 | 257.2 | 28.5 | 5.6 |
| 17.5-17.9 | | | 442 | 339 | | 781 | 250.8 | 32.1 | 5.7 |
| 18.0-18.4 | | | 271 | 230 | | 501 | 182.8 | 36.5 | 6.0 |
| 18.5-18.9 | | | 178 | 108 | | 286 | 115.0 | 40.2 | 6.1 |
| 19.0-19.4 | | | 131 | 85 | | 216 | 91.3 | 42.3 | 5.9 |
| 19.5-19.9 | | | 19 | 55 | | 74 | 36.5 | 49.3 | 6.4 |
| ANTALL: | 27099 | 19663 | 15413 | 3262 | 30 | 65467 | | | |
| GJ.LGD: | 10.60 | 12.91 | 15.31 | 16.57 | 16.23 | 12.70 | | | |
| VEKT : | 1223.51852.52797.7 | 805.8 | 5.9 | 6685.4 | | | | | |
| GJ.VOL: | 4.5 | 9.4 | 18.2 | 24.7 | 19.8 | 10.2 | | | |
| KOND. : | 3.6 | 4.2 | 4.8 | 5.2 | 4.6 | 4.1 | | | |

Legend as in Table 1.

Table 10. Acoustic abundance estimate of capelin, autumn 1981.

| Alder | | | | | | | | | |
|-----------|--------|-------|-------|-------|-------|--------|-------|--------|-------|
| LENGDE | 1 | 2 | 3 | 4 | 5 | TOT | VEKT | GJ.VOL | KOND. |
| 3.0-3.4 | 59 | | | | | 59 | 0.1 | 0.1 | 2.9 |
| 3.5-3.9 | 434 | | | | | 434 | 0.4 | 0.1 | 1.9 |
| 4.0-4.4 | 451 | | | | | 451 | 0.9 | 0.2 | 2.6 |
| 4.5-4.9 | 690 | | | | | 690 | 2.1 | 0.3 | 2.8 |
| 5.0-5.4 | 535 | | | | | 535 | 2.1 | 0.4 | 2.8 |
| 5.5-5.9 | 610 | | | | | 610 | 3.0 | 0.5 | 2.6 |
| 6.0-6.4 | 795 | | | | | 795 | 5.6 | 0.7 | 2.9 |
| 6.5-6.9 | 1805 | | | | | 1805 | 16.2 | 0.9 | 2.9 |
| 7.0-7.4 | 3180 | | | | | 3180 | 31.8 | 1.0 | 2.6 |
| 7.5-7.9 | 5814 | | | | | 5814 | 75.7 | 1.3 | 2.8 |
| 8.0-8.4 | 6387 | | | | | 6387 | 115.2 | 1.8 | 3.2 |
| 8.5-8.9 | 5723 | 8 | | | | 5731 | 120.6 | 2.1 | 3.1 |
| 9.0-9.4 | 5188 | 34 | | | | 5222 | 135.0 | 2.6 | 3.3 |
| 9.5-9.9 | 4142 | 132 | | | | 4274 | 129.3 | 3.0 | 3.3 |
| 10.0-10.4 | 2643 | 256 | | | | 2899 | 108.2 | 3.7 | 3.5 |
| 10.5-10.9 | 2162 | 470 | | | | 2632 | 113.6 | 4.3 | 3.5 |
| 11.0-11.4 | 786 | 896 | | | | 1682 | 88.5 | 5.3 | 3.7 |
| 11.5-11.9 | 299 | 1743 | 5 | | | 2047 | 127.4 | 6.2 | 3.8 |
| 12.0-12.4 | 162 | 3069 | 19 | | | 3250 | 233.7 | 7.2 | 3.9 |
| 12.5-12.9 | 125 | 4195 | 59 | | | 4379 | 363.5 | 8.3 | 4.0 |
| 13.0-13.4 | 50 | 3276 | 229 | 4 | | 3559 | 342.4 | 9.6 | 4.1 |
| 13.5-13.9 | 20 | 2347 | 466 | 1 | | 2834 | 315.1 | 11.1 | 4.3 |
| 14.0-14.4 | 7 | 1532 | 641 | 2 | | 2182 | 276.5 | 12.7 | 4.4 |
| 14.5-14.9 | | 676 | 701 | 20 | | 1397 | 201.4 | 14.4 | 4.5 |
| 15.0-15.4 | | 355 | 705 | 140 | 4 | 1204 | 197.4 | 16.4 | 4.6 |
| 15.5-15.9 | | 166 | 697 | 199 | | 1060 | 189.8 | 17.9 | 4.6 |
| 16.0-16.4 | | 94 | 468 | 197 | 2 | 761 | 155.4 | 20.4 | 4.8 |
| 16.5-16.9 | | 79 | 344 | 259 | | 682 | 155.6 | 22.8 | 4.9 |
| 17.0-17.4 | | 67 | 157 | 172 | 4 | 400 | 106.7 | 26.7 | 5.2 |
| 17.5-17.9 | | 52 | 162 | 182 | 6 | 402 | 120.0 | 29.8 | 5.3 |
| 18.0-18.4 | | 38 | 66 | 129 | | 233 | 77.7 | 33.3 | 5.5 |
| 18.5-18.9 | | 17 | 51 | 49 | 10 | 127 | 46.3 | 36.4 | 5.5 |
| 19.0-19.4 | | | 15 | 2 | | 17 | 7.8 | 46.0 | 6.4 |
| 19.5-19.9 | | | 5 | 19 | | 24 | 11.5 | 48.0 | 6.2 |
| 20.0-20.4 | | | 1 | 3 | | 4 | 2.3 | 58.5 | 7.0 |
| 20.5-20.9 | | | 2 | | | 2 | 1.3 | 63.0 | 7.1 |
| ANTALL: | 42067 | 19500 | 4793 | 1378 | 26 | 67764 | | | |
| GJ.LGD: | 8.49 | 12.94 | 15.28 | 16.80 | 17.56 | 10.42 | | | |
| VEKT: | 913.51 | 823.3 | 814.5 | 321.6 | 7.5 | 3880.4 | | | |
| GJ.VOL: | 2.2 | 9.4 | 17.0 | 23.3 | 28.7 | 5.7 | | | |
| KOND.: | 3.1 | 4.1 | 4.6 | 4.8 | 5.2 | 3.5 | | | |

Legend as in Table 1.

Table 11. Acoustic abundance estimate of capelin, autumn 1982.

| Lenade | Alder | | | | | Tot | Vekt | Gj.vol | Kond. |
|-----------|---------|--------|-------|-------|------|--------|-------|--------|-------|
| | 1 | 2 | 3 | 4 | 5 | | | | |
| 6.5- 6.9 | 4631 | | | | | 4631 | 46.1 | 1.0 | 3.2 |
| 7.0- 7.4 | 6164 | | | | | 6164 | 61.8 | 1.0 | 2.6 |
| 7.5- 7.9 | 7089 | | | | | 7089 | 78.4 | 1.1 | 2.4 |
| 8.0- 8.4 | 3852 | | | | | 3852 | 62.2 | 1.6 | 2.9 |
| 8.5- 8.9 | 4618 | | | | | 4618 | 92.0 | 2.1 | 3.1 |
| 9.0- 9.4 | 5449 | 71 | | | | 5520 | 151.7 | 2.7 | 3.5 |
| 9.5- 9.9 | 5992 | 108 | | | | 6100 | 191.2 | 3.1 | 3.4 |
| 10.0-10.4 | 5542 | 429 | | | | 5971 | 224.0 | 3.8 | 3.5 |
| 10.5-10.9 | 3682 | 1826 | | | | 5508 | 243.4 | 4.4 | 3.6 |
| 11.0-11.4 | 1549 | 3123 | | | | 4672 | 248.0 | 5.3 | 3.7 |
| 11.5-11.9 | 913 | 4872 | | | | 5785 | 357.1 | 6.2 | 3.8 |
| 12.0-12.4 | 315 | 5359 | 6 | | | 5680 | 417.1 | 7.3 | 4.0 |
| 12.5-12.9 | 30 | 4787 | 26 | | | 4843 | 408.8 | 8.4 | 4.1 |
| 13.0-13.4 | 4 | 3366 | 46 | | | 3416 | 339.8 | 9.9 | 4.3 |
| 13.5-13.9 | | 2638 | 168 | | | 2806 | 319.5 | 11.4 | 4.4 |
| 14.0-14.4 | | 1421 | 654 | | | 2075 | 273.3 | 13.2 | 4.6 |
| 14.5-14.9 | | 1229 | 685 | 3 | | 1917 | 283.2 | 14.8 | 4.6 |
| 15.0-15.4 | | 654 | 1047 | 14 | | 1715 | 292.5 | 17.1 | 4.8 |
| 15.5-15.9 | | 336 | 1011 | 54 | | 1401 | 265.2 | 18.9 | 4.8 |
| 16.0-16.4 | | 110 | 731 | 47 | | 888 | 188.9 | 21.3 | 5.0 |
| 16.5-16.9 | | 199 | 631 | 32 | | 862 | 213.7 | 24.8 | 5.3 |
| 17.0-17.4 | | 190 | 558 | 19 | | 767 | 214.0 | 27.9 | 5.4 |
| 17.5-17.9 | | 300 | 307 | 20 | | 627 | 194.7 | 31.0 | 5.6 |
| 18.0-18.4 | | 42 | 259 | | | 301 | 103.8 | 34.5 | 5.7 |
| 18.5-18.9 | | 26 | 57 | | | 83 | 29.8 | 35.9 | 5.4 |
| 19.0-19.4 | | | 87 | 14 | | 101 | 40.7 | 40.3 | 5.6 |
| 19.5-19.9 | | 14 | 79 | 14 | | 57 | 24.7 | 43.3 | 5.6 |
| 20.0-20.4 | | | 14 | | | 14 | 7.0 | 50.0 | 6.0 |
| Antall: | 49630 | 31100 | 6316 | 217 | 0 | 87263 | | | |
| Gj. lad: | 8.85 | 12.69 | 15.91 | 16.76 | 0.00 | 10.75 | | | |
| Vekt : | 1210.82 | 789.21 | 318.1 | 54.0 | 0.0 | 5372.2 | | | |
| Gj.vol: | 2.4 | 9.0 | 20.9 | 24.9 | 0.0 | 6.2 | | | |
| Kond. : | 3.1 | 4.1 | 5.0 | 5.1 | 0.0 | 3.6 | | | |

Legend as in Table 1.

Table 12. Acoustic abundance estimate of capelin, autumn 1983.

| Alder | | | | | | | | | |
|-----------|--------|---------|-------|-------|------|--------|-------|-------|--|
| Lengde | 1 | 2 | 3 | 4 | 5 | Tot | Vekt | G.j.v | |
| 6.5- 6.9 | 527 | | | | | 527 | 5.3 | 1.0 | |
| 7.0- 7.4 | 718 | | | | | 718 | 7.2 | 1.0 | |
| 7.5- 7.9 | 1016 | | | | | 1016 | 10.9 | 1.1 | |
| 8.0- 8.4 | 2756 | | | | | 2756 | 55.7 | 2.0 | |
| 8.5- 8.9 | 9643 | | | | | 9643 | 208.3 | 2.2 | |
| 9.0- 9.4 | 11953 | 146 | | | | 12099 | 340.1 | 2.8 | |
| 9.5- 9.9 | 10966 | 291 | | | | 11257 | 353.2 | 3.1 | |
| 10.0-10.4 | 6710 | 440 | | | | 7150 | 278.1 | 3.9 | |
| 10.5-10.9 | 3815 | 1571 | | | | 5386 | 249.8 | 4.6 | |
| 11.0-11.4 | 2161 | 2339 | | | | 4500 | 249.1 | 5.5 | |
| 11.5-11.9 | 849 | 2467 | | | | 3316 | 212.6 | 6.4 | |
| 12.0-12.4 | 216 | 3013 | 27 | | | 3256 | 248.3 | 7.6 | |
| 12.5-12.9 | 144 | 2393 | 64 | | | 2601 | 231.1 | 8.9 | |
| 13.0-13.4 | 14 | 2212 | 232 | | | 2458 | 253.0 | 10.3 | |
| 13.5-13.9 | | 1425 | 252 | | | 1677 | 199.2 | 11.9 | |
| 14.0-14.4 | 5 | 1152 | 532 | | | 1689 | 231.2 | 13.7 | |
| 14.5-14.9 | 9 | 812 | 464 | | | 1287 | 199.4 | 15.5 | |
| 15.0-15.4 | | 734 | 521 | 7 | | 1262 | 225.6 | 17.9 | |
| 15.5-15.9 | | 388 | 438 | 6 | | 832 | 168.8 | 20.3 | |
| 16.0-16.4 | 9 | 278 | 545 | 14 | | 846 | 192.0 | 22.7 | |
| 16.5-16.9 | | 165 | 277 | 9 | | 451 | 117.1 | 26.0 | |
| 17.0-17.4 | | 107 | 264 | | | 371 | 106.1 | 28.6 | |
| 17.5-17.9 | | 33 | 133 | | | 166 | 54.1 | 32.6 | |
| 18.0-18.4 | | 11 | 36 | | | 47 | 16.1 | 34.3 | |
| 18.5-18.9 | | 18 | 22 | | | 40 | 16.1 | 40.2 | |
| 19.0-19.4 | | 1 | 2 | | | 3 | 1.3 | 45.0 | |
| Antall: | 51511 | 19996 | 3811 | 36 | 0 | 75354 | | | |
| Gj.lgd: | 9.52 | 12.66 | 15.35 | 16.10 | 0.00 | 10.65 | | | |
| Vekt: | 1609.1 | 11893.3 | 720.4 | 7.0 | 0.0 | 4229.8 | | | |
| Gj.vol: | 3.1 | 9.5 | 18.9 | 19.4 | 0.0 | 5.6 | | | |
| Kond.: | 3.5 | 4.3 | 5.0 | 4.4 | 0.0 | 3.8 | | | |

Legend as in Table 1.

Table 13. Acoustic abundance estimate of capelin, autumn 1984.

| Lengde | Alder | | | | | Tot | Vekt | Gj.v |
|-----------|-------|--------|-------|-------|------|--------|-------|------|
| | 1 | 2 | 3 | 4 | 5 | | | |
| 8.0- 8.4 | 266 | 14 | | | | 280 | 5.2 | 1.9 |
| 8.5- 8.9 | 998 | | | | | 998 | 20.4 | 2.0 |
| 9.0- 9.4 | 2719 | 34 | | | | 2753 | 72.6 | 2.6 |
| 9.5- 9.9 | 3848 | 391 | | | | 4239 | 132.9 | 3.1 |
| 10.0-10.4 | 2515 | 1388 | | | | 3903 | 153.6 | 3.9 |
| 10.5-10.9 | 2076 | 2443 | 25 | | | 4544 | 204.8 | 4.5 |
| 11.0-11.4 | 1277 | 2951 | 80 | | | 4308 | 226.7 | 5.3 |
| 11.5-11.9 | 515 | 3009 | 114 | | | 3638 | 219.5 | 6.0 |
| 12.0-12.4 | 125 | 2692 | 194 | | | 3011 | 213.9 | 7.1 |
| 12.5-12.9 | 139 | 1742 | 163 | | | 2044 | 171.6 | 8.4 |
| 13.0-13.4 | 39 | 1384 | 284 | | | 1707 | 166.7 | 9.8 |
| 13.5-13.9 | 25 | 739 | 409 | | | 1173 | 134.2 | 11.4 |
| 14.0-14.4 | 2 | 513 | 501 | | | 1016 | 137.5 | 13.5 |
| 14.5-14.9 | | 347 | 489 | | | 836 | 122.8 | 14.7 |
| 15.0-15.4 | | 213 | 541 | 37 | | 791 | 136.0 | 17.2 |
| 15.5-15.9 | | 153 | 421 | 37 | | 611 | 115.7 | 18.9 |
| 16.0-16.4 | | 127 | 395 | 39 | | 561 | 121.5 | 21.7 |
| 16.5-16.9 | | 82 | 297 | 59 | | 438 | 110.0 | 25.1 |
| 17.0-17.4 | | 94 | 328 | 33 | | 455 | 128.9 | 28.3 |
| 17.5-17.9 | | 51 | 226 | 24 | | 301 | 95.7 | 31.8 |
| 18.0-18.4 | | 6 | 157 | 24 | | 187 | 66.6 | 35.6 |
| 18.5-18.9 | | 11 | 76 | 32 | | 119 | 46.0 | 38.7 |
| 19.0-19.4 | | 2 | 62 | 14 | | 78 | 33.5 | 43.0 |
| 19.5-19.9 | | | 31 | 10 | | 41 | 19.2 | 46.7 |
| 20.0-20.4 | | | 2 | 10 | | 12 | 6.4 | 53.3 |
| 20.5-20.9 | | | | 3 | | 3 | 1.8 | 60.0 |
| Antall: | 14544 | 18386 | 4795 | 322 | 0 | 38047 | | |
| Gj.lgd: | 10.06 | 12.04 | 15.18 | 17.19 | 0.00 | 11.72 | | |
| Vekt: | 535.8 | 1367.8 | 872.7 | 87.4 | 0.0 | 2863.7 | | |
| Gj.vol: | 3.7 | 7.4 | 18.2 | 27.1 | 0.0 | 7.5 | | |
| Kond.: | 3.5 | 3.9 | 4.8 | 5.1 | 0.0 | 3.9 | | |

Legend as in Table 1.

Table 14. Mean temperature (\bar{t}) and standard deviation (s) in the distribution area of 1, 2, 3, and 4 years old capelin in the period 1974 - 1982 (Loeng, Nakken, and Raknes, 1983).

| Year | Age, years | | | | | | | |
|------|---------------------------|------|---------------------------|------|---------------------------|------|---------------------------|------|
| | 1 | | 2 | | 3 | | 4 | |
| | $\bar{t}^{\circ}\text{C}$ | s | $\bar{t}^{\circ}\text{C}$ | s | $\bar{t}^{\circ}\text{C}$ | s | $\bar{t}^{\circ}\text{C}$ | s |
| 1974 | 1.04 | 1.46 | -0.15 | 1.00 | -0.18 | 0.99 | 0.32 | 1.11 |
| 1975 | 0.61 | 1.01 | -0.03 | 0.88 | -0.29 | 0.74 | -0.26 | 0.78 |
| 1976 | 1.34 | 1.04 | 0.16 | 0.98 | 0.46 | 1.09 | 0.76 | 1.21 |
| 1977 | 1.66 | 1.36 | -0.32 | 0.72 | -0.38 | 0.59 | -0.37 | 0.59 |
| 1978 | 1.78 | 1.10 | 0.03 | 1.07 | -0.11 | 0.77 | 0.13 | 0.69 |
| 1979 | 0.72 | 1.13 | -0.05 | 0.86 | -0.19 | 0.69 | -0.05 | 0.72 |
| 1980 | 1.36 | 0.94 | 0.78 | 0.91 | 0.68 | 0.88 | 0.85 | 0.89 |
| 1981 | 1.51 | 0.78 | 0.63 | 0.88 | 0.53 | 0.95 | 0.53 | 0.90 |
| 1982 | 2.38 | 1.21 | 1.12 | 1.22 | 0.99 | 0.91 | 1.13 | 0.83 |

Table 15. Average weight in grams of 2 and 3 years old capelin together with mean temperatures (\bar{t}) in the distribution area. The individual growth (in grams) of capelin from 2 to 3 years of age is shown in the column to the right (Loeng, Nakken and Raknes 1983).

| Year | Age, years | | | | Weight increase 2 to 3 years |
|------|------------------------|---------------------------|------------------------|---------------------------|---------------------------------|
| | Weight(g) ² | $\bar{t}^{\circ}\text{C}$ | Weight(g) ³ | $\bar{t}^{\circ}\text{C}$ | |
| 1974 | 5.6 | -0.15 | 9.1 | -0.18 | |
| 1975 | 6.8 | -0.03 | 10.4 | -0.29 | 4.8 |
| 1976 | 8.2 | (0.16) | 12.4 | (0.46) | 5.6 |
| 1977 | 8.1 | -0.32 | 16.8 | -0.38 | 8.6 |
| 1978 | 6.7 | 0.03 | 16.5 | -0.11 | 8.4 |
| 1979 | 7.4 | -0.05 | 13.5 | -0.19 | 6.8 |
| 1980 | 9.4 | 0.78 | 18.2 | 0.68 | 10.8 |
| 1981 | 9.4 | 0.63 | 17.0 | 0.53 | 7.6 |
| 1982 | 9.4 | 1.12 | 17.0 | 0.99 | 7.6 |

Table 16. Ratio between average integrator values obtained during day, (\bar{M}_D), and night, (\bar{M}_N), on capelin recordings in the Barents Sea in autumn onboard the "G.O. Sars" (Aglen, 1983a).

| Year: | 1974 | 1975 | 1976 | 1977 | 1978 | Average |
|-------------------------|------|------|------|------|------|---------|
| \bar{M}_D / \bar{M}_N | 0.9 | 1.4 | 0.7 | 0.9 | 1.2 | 1.0 |

Table 17. Instantaneous natural mortality for Barents Sea capelin by yearclass and age, as obtained by combining acoustic estimates and catch statistics (Dommasnes, 1981).

| Age | Yearclass | | | | | | |
|-------------|-----------|------|------|------|------|------|------|
| | 1971 | 1972 | 1973 | 1974 | 1975 | 1976 | 1977 |
| 2 - 3 years | | | 0.67 | 0.63 | 0.35 | 1.03 | 0.64 |
| 3 - 4 " | | 1.00 | 0.68 | 0.88 | 1.80 | 0.37 | |
| 4 - 5 " | 1.16 | 1.20 | 2.14 | 2.66 | 0.01 | | |

Table 18. Instantaneous natural mortality for immature Barents Sea capelin by yearclass and age. Adapted from Hamre and Tjelmeland, 1982.

| Age | Yearclass | | | | | | | |
|-------------|-----------|------|------|------|------|------|------|------|
| | 1970 | 1971 | 1972 | 1973 | 1974 | 1975 | 1976 | 1977 |
| 2 - 3 years | | 0.67 | 0.56 | 0.61 | 0.58 | 0.56 | 1.02 | 0.64 |
| 3 - 4 " | 0.68 | 0.53 | 0.82 | 0.64 | 0.84 | 0.96 | 0.60 | |

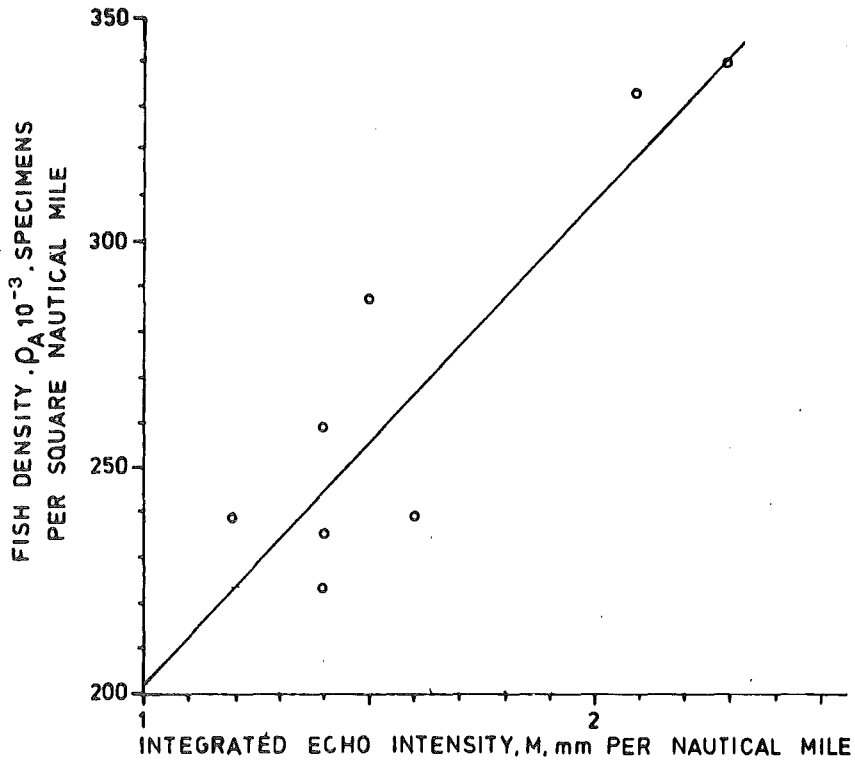


Figure 1. Corresponding values of integrated echo intensity and capelin density (calculated from counts on the recording paper) in 1971. R/V "G.O. Sars".

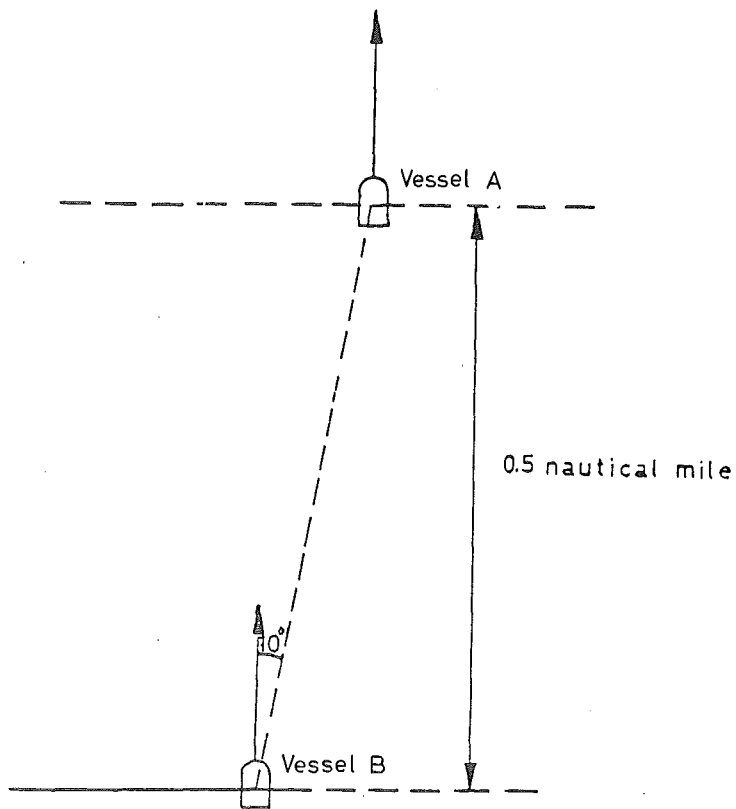


Figure 2. Sailing arrangement during intercalibrations on fish concentrations.

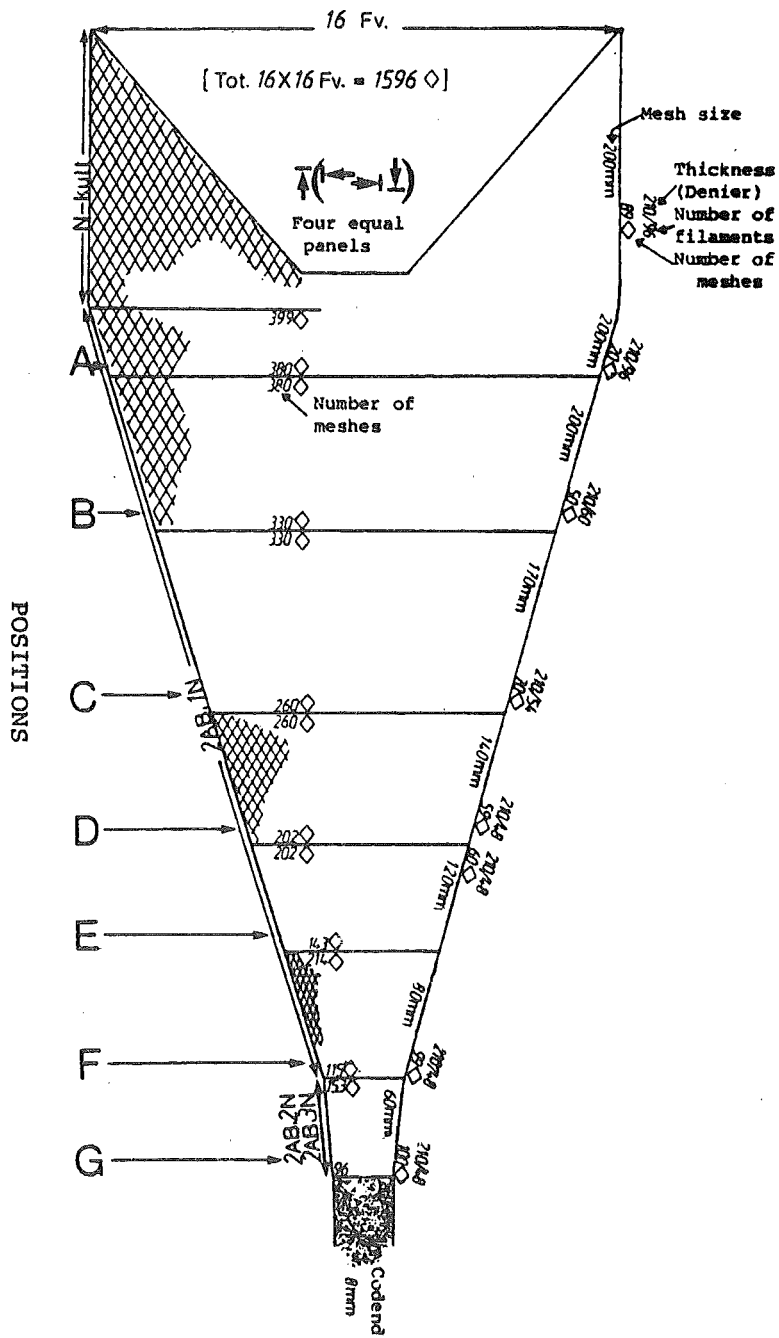


Figure 3. 16 x 16 fathom capelin trawl used for biological sampling on capelin surveys.

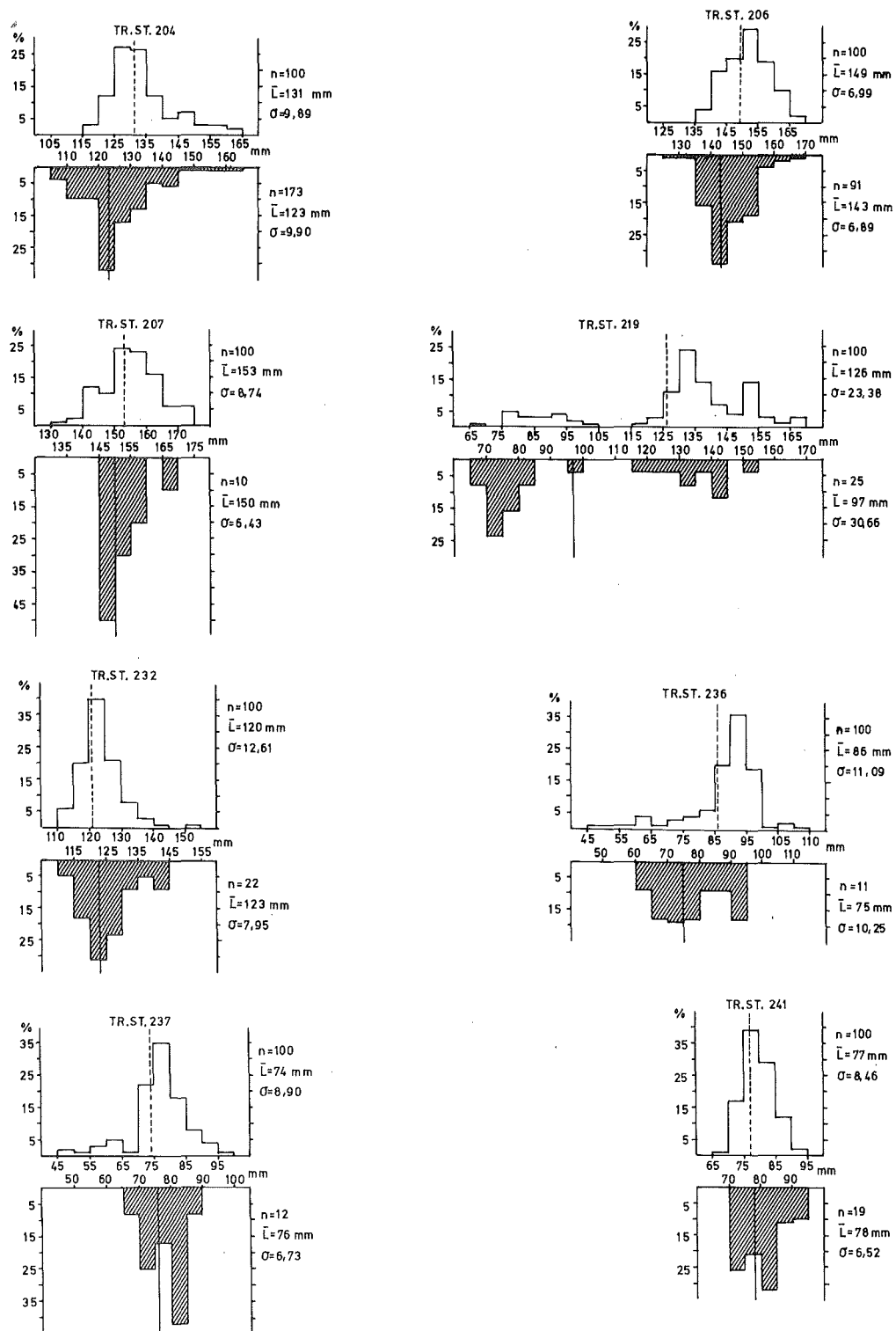


Figure 4. Length frequency distribution from codend-catch (white boxes) and of escaped capelin (hatched boxes). (From Larsen, 1984).

n = number of length measured individuals.
 \bar{L} = mean length
 σ = standard deviation

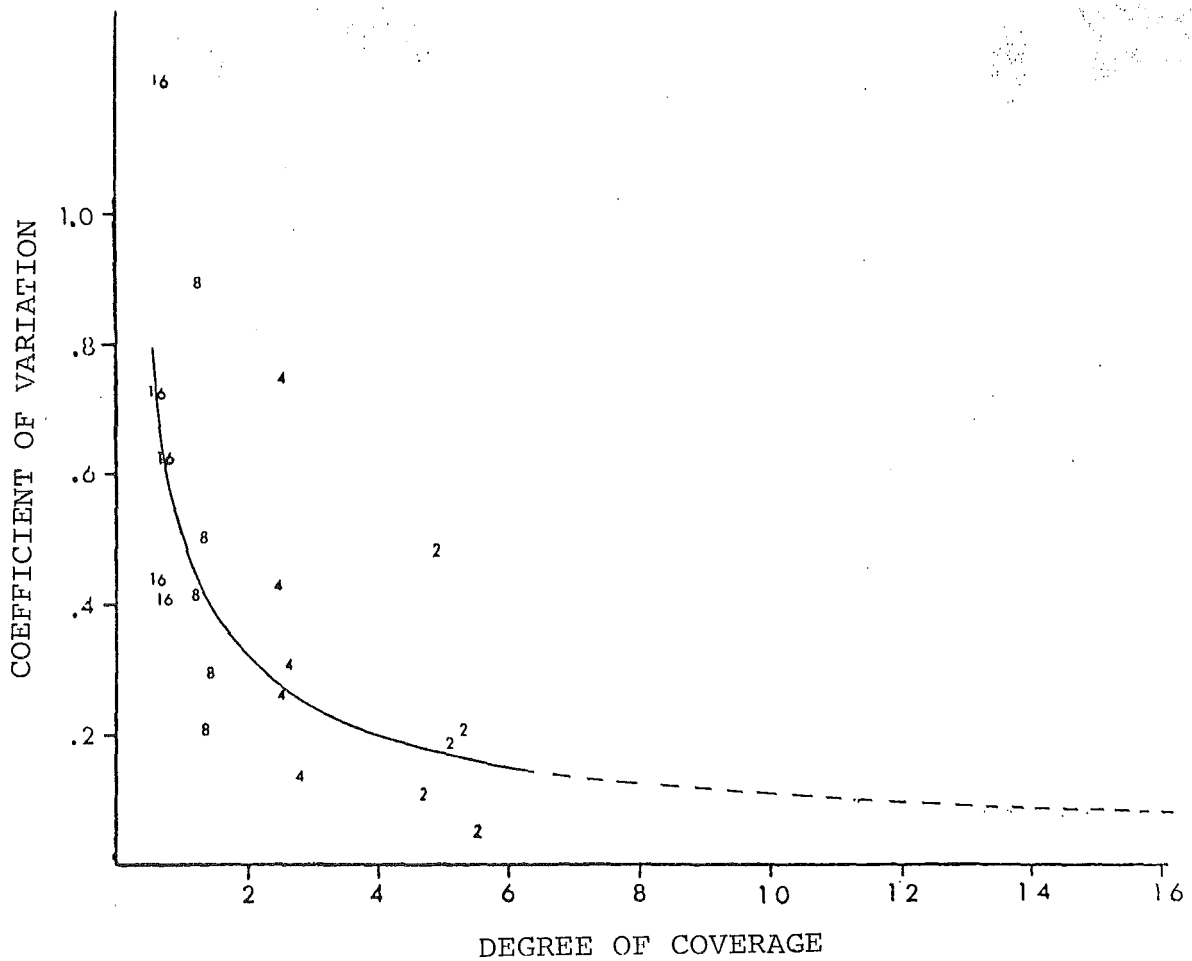


Figure 5. Corresponding values of degree of coverage and coefficient of variation for capelin surveys in the Barents Sea. Numbers denote number of observations. (Modified from Aglen 1983a).

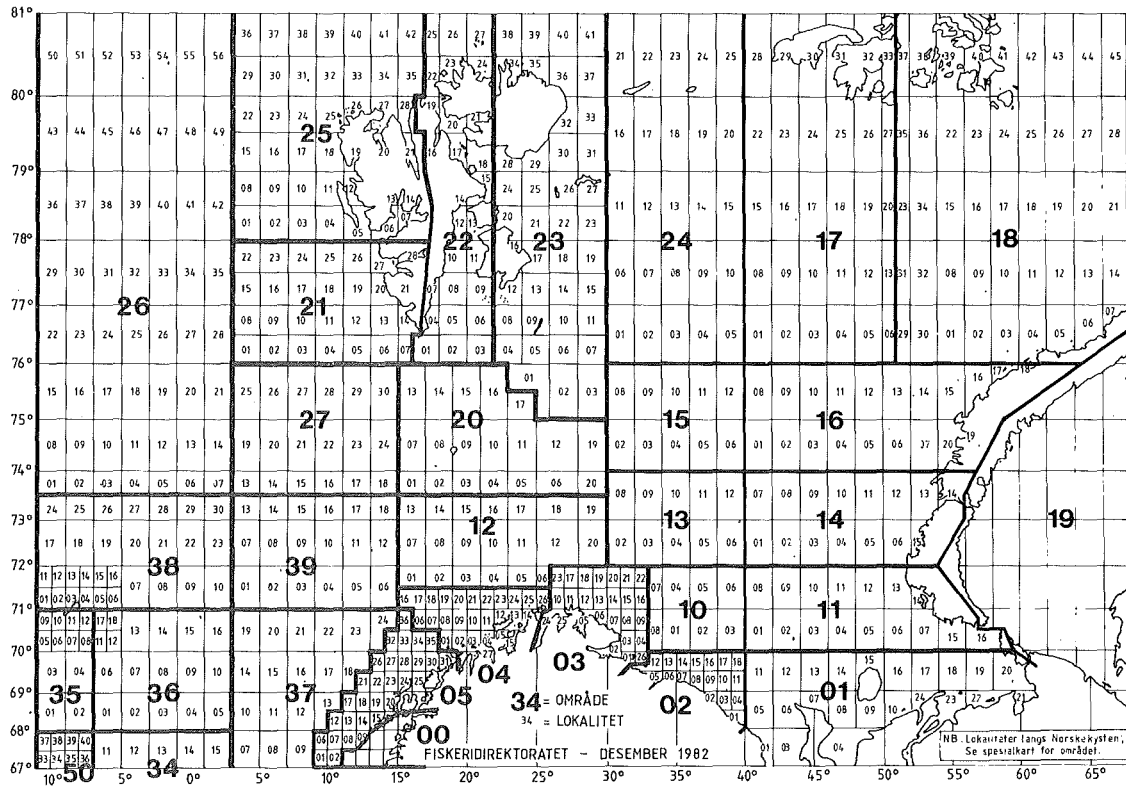


Figure 6. Areas ("squares") used in Norwegian Fisheries statistics.

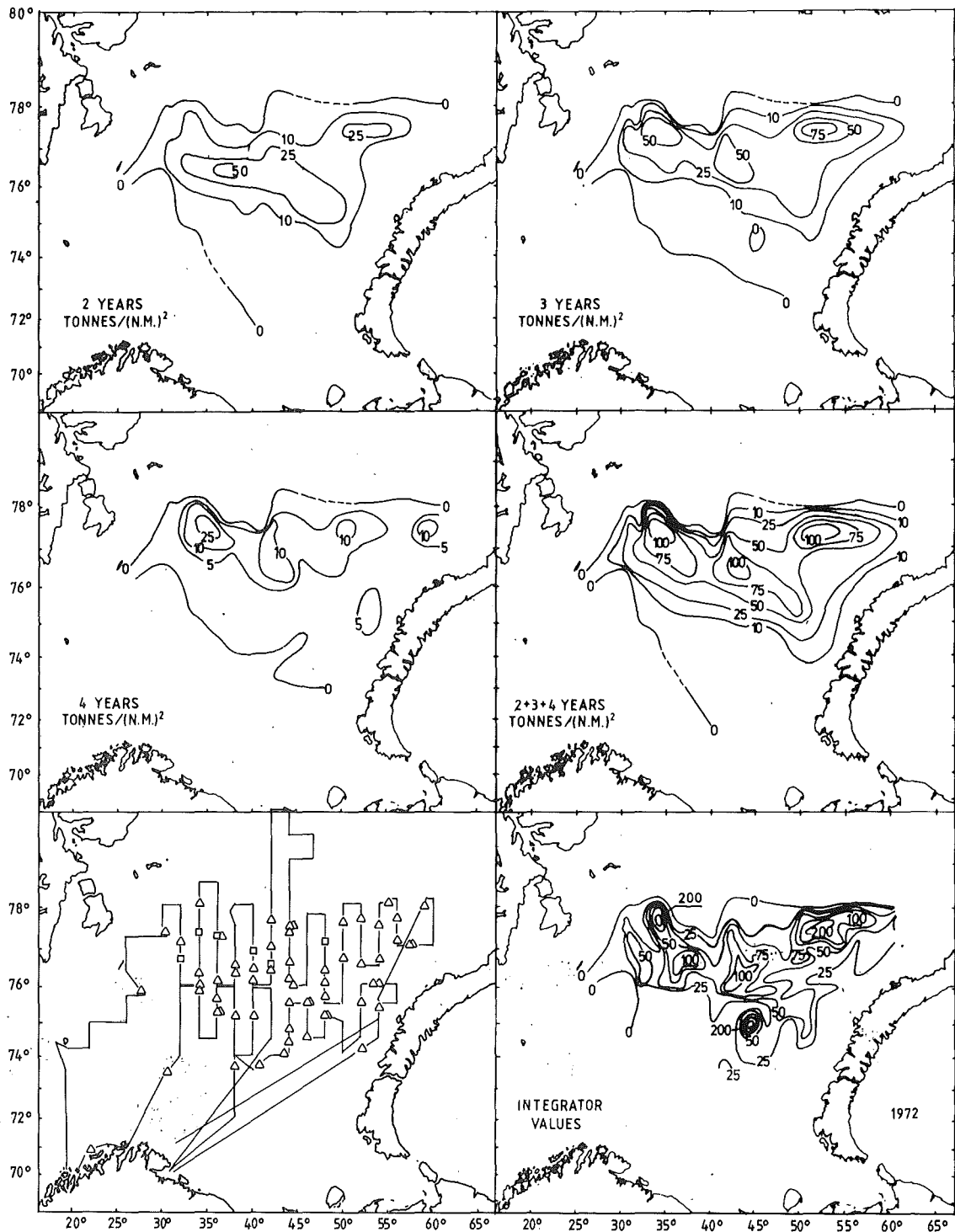


Figure 7. Calculated biomass distribution for 2-, 3- and 4-year-old capelin in 1972, total biomass distribution for 2-year-olds and older capelin, cruise track during the survey, and distribution of integrator values. Δ = pelagic trawl station, \circ = bottom trawl station, vvvvvv = observations of ice.

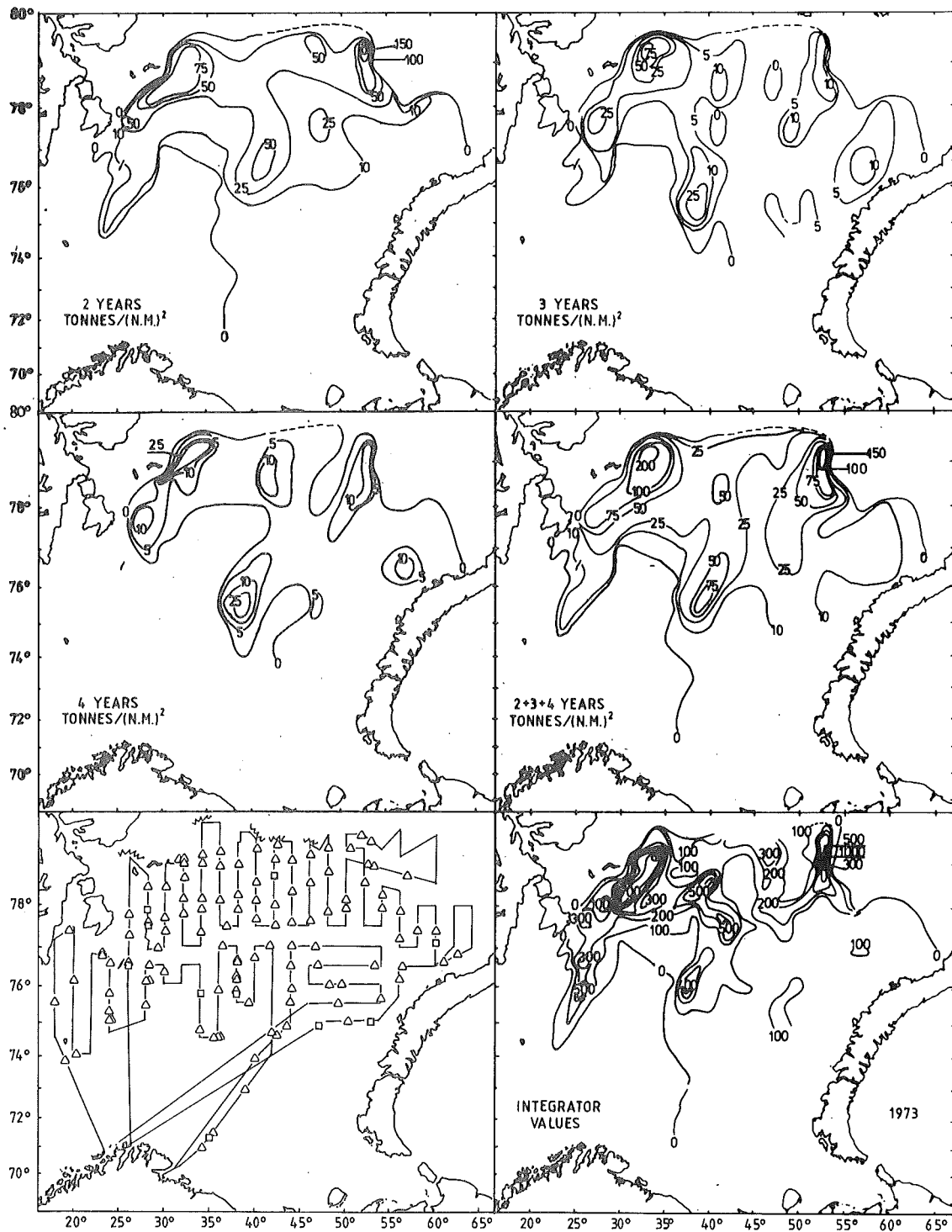


Figure 8. Calculated biomass distribution for 2-, 3- and 4-year-old capelin in 1973, total biomass distribution for 2-year-olds and older capelin, cruise track during the survey, and distribution of integrator values. Legend as in Figure 7.

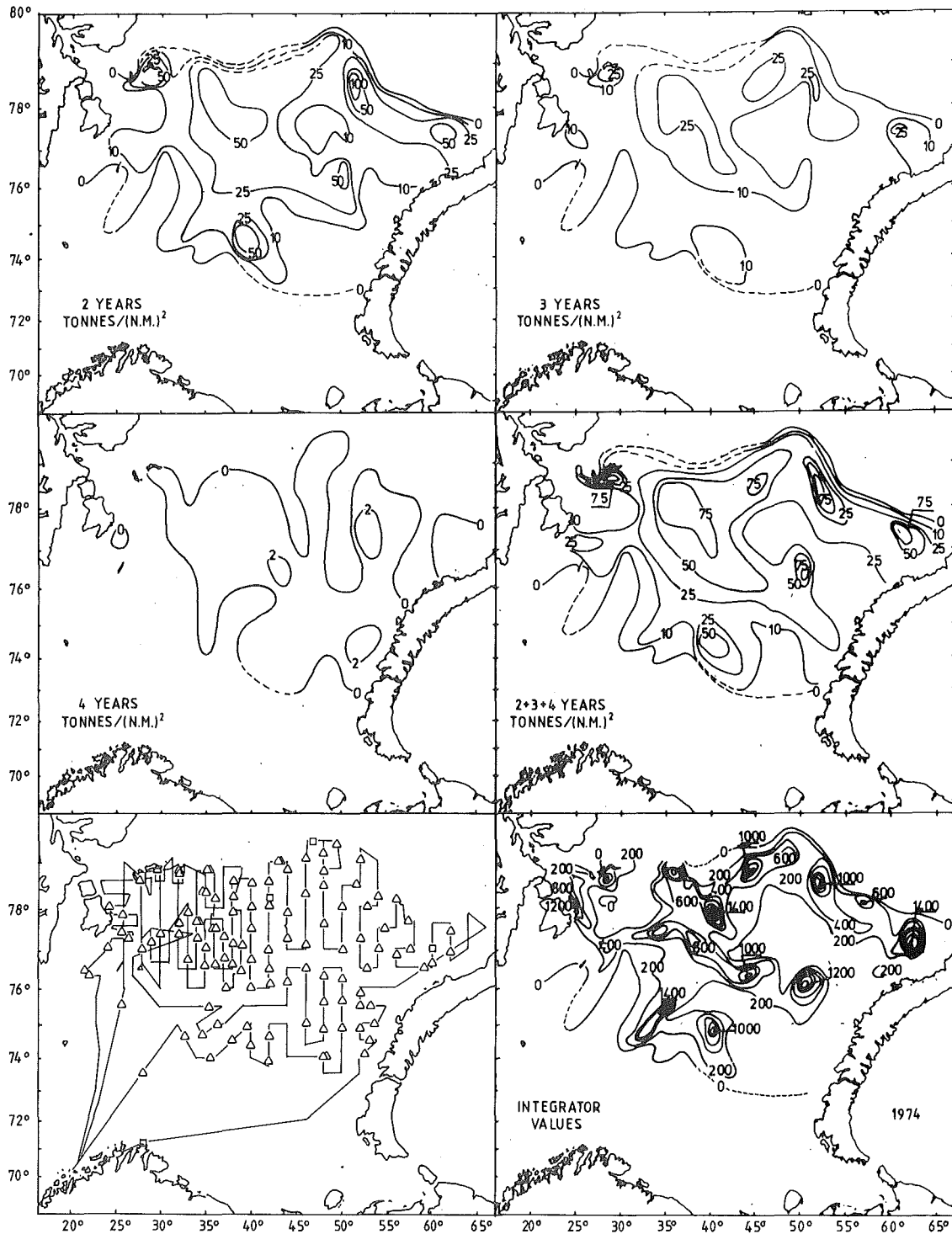


Figure 9. Calculated biomass distribution for 2-, 3- and 4-year-old capelin in 1974, total biomass distribution for 2-year-olds and older capelin, cruise track during the survey, and distribution of integrator values. Legend as in Figure 7.

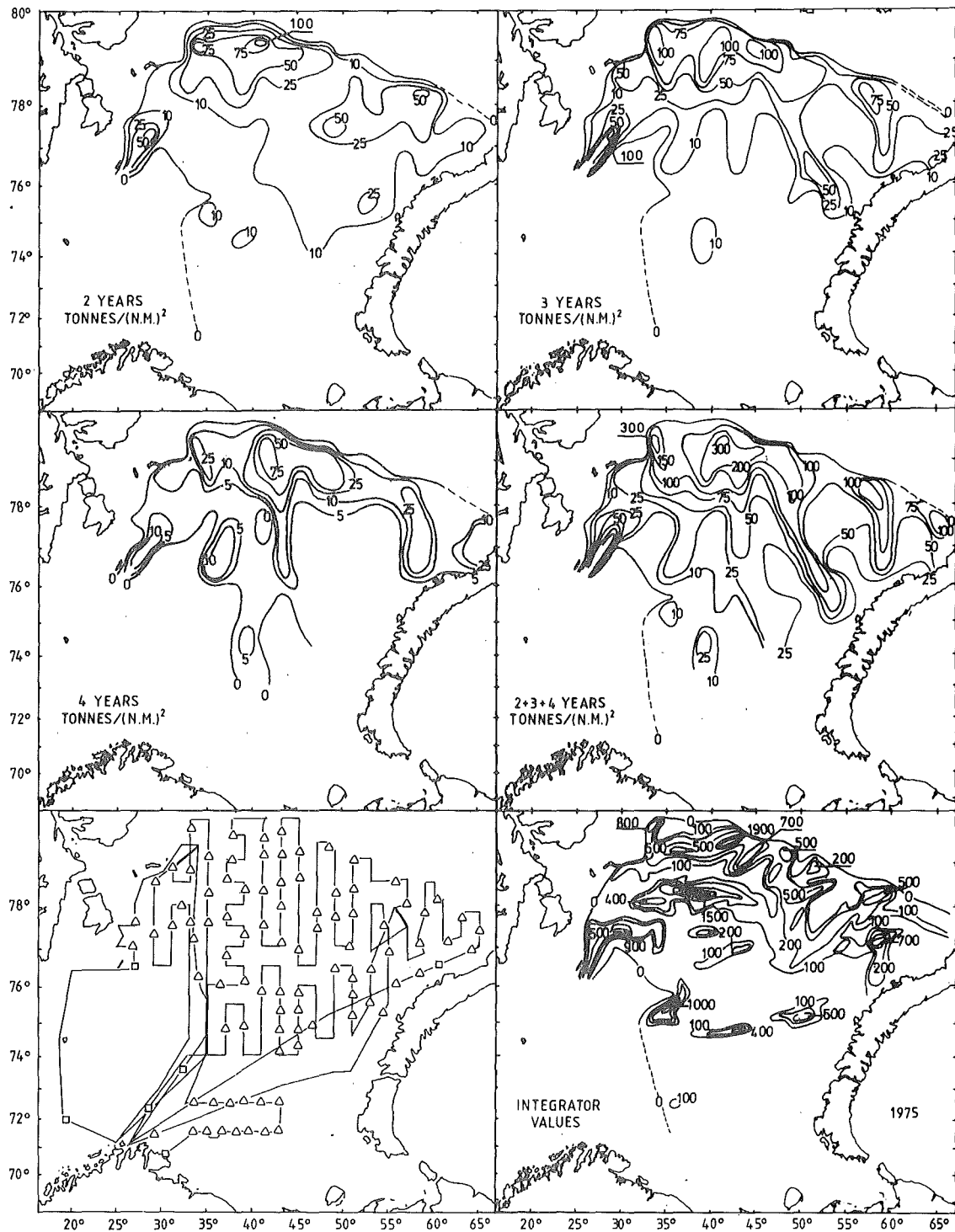


Figure 10. Calculated biomass distribution for 2-, 3- and 4-year-old capelin in 1975, total biomass distribution for 2-year-olds and older capelin, cruise track during the survey, and distribution of integrator values. Legend as in Figure 7.

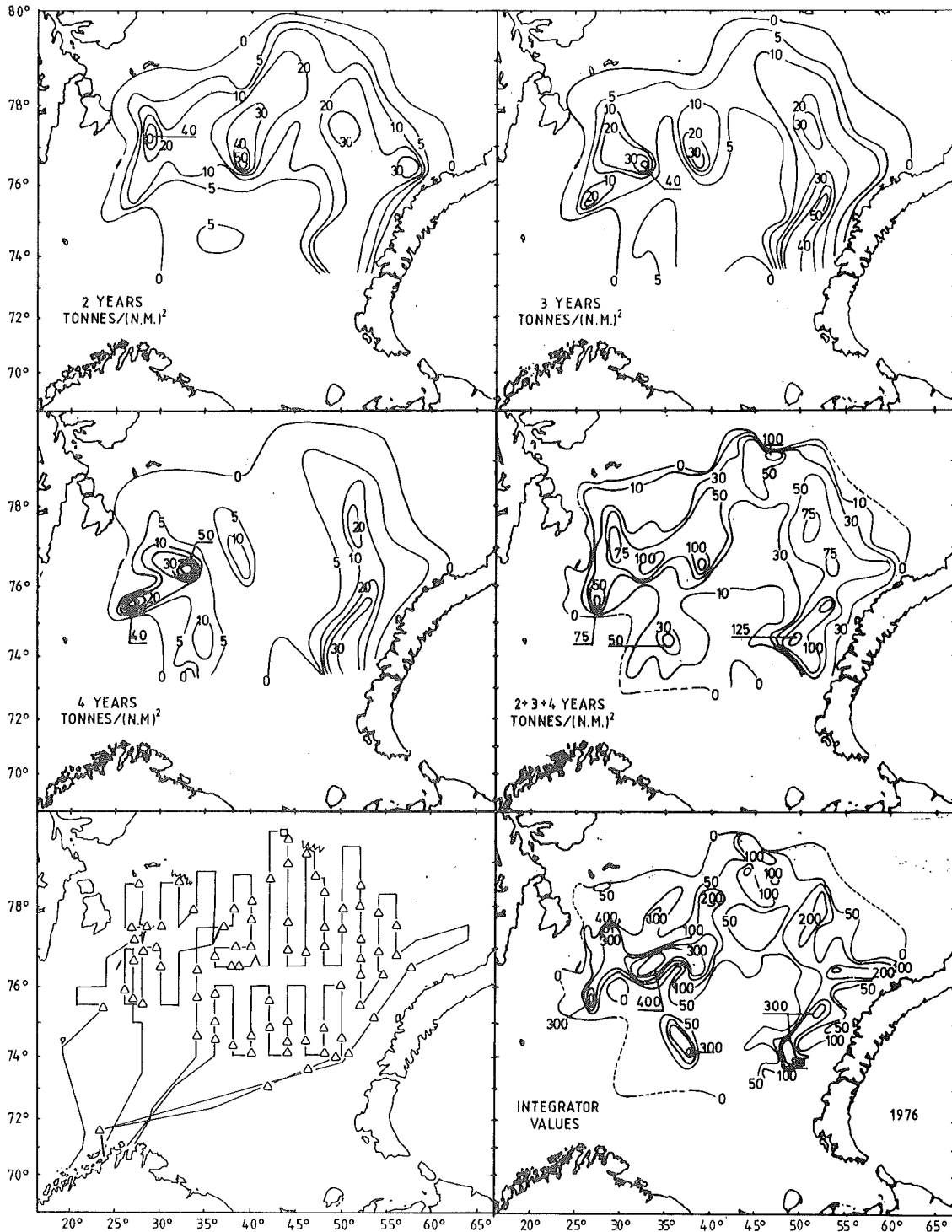


Figure 11. Calculated biomass distribution for 2-, 3- and 4-year-old capelin in 1976, total biomass distribution for 2-year-olds and older capelin, cruise track during the survey, and distribution of integrator values. Legend as in Figure 7.

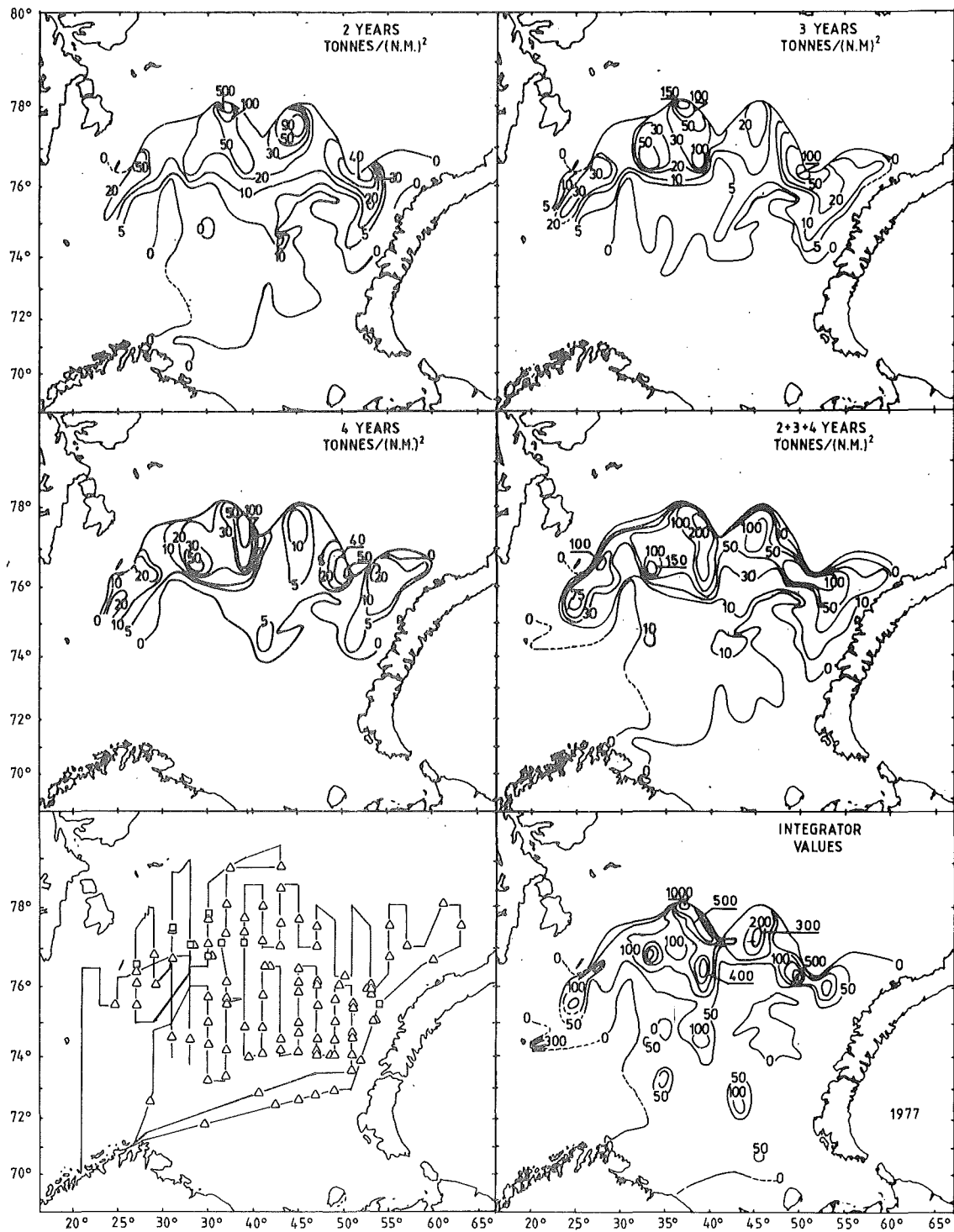


Figure 12. Calculated biomass distribution for 2-, 3- and 4-year-old capelin in 1977, total biomass distribution for 2-year-olds and older capelin, cruise track during the survey, and distribution of integrator values. Legend as in Figure 7.

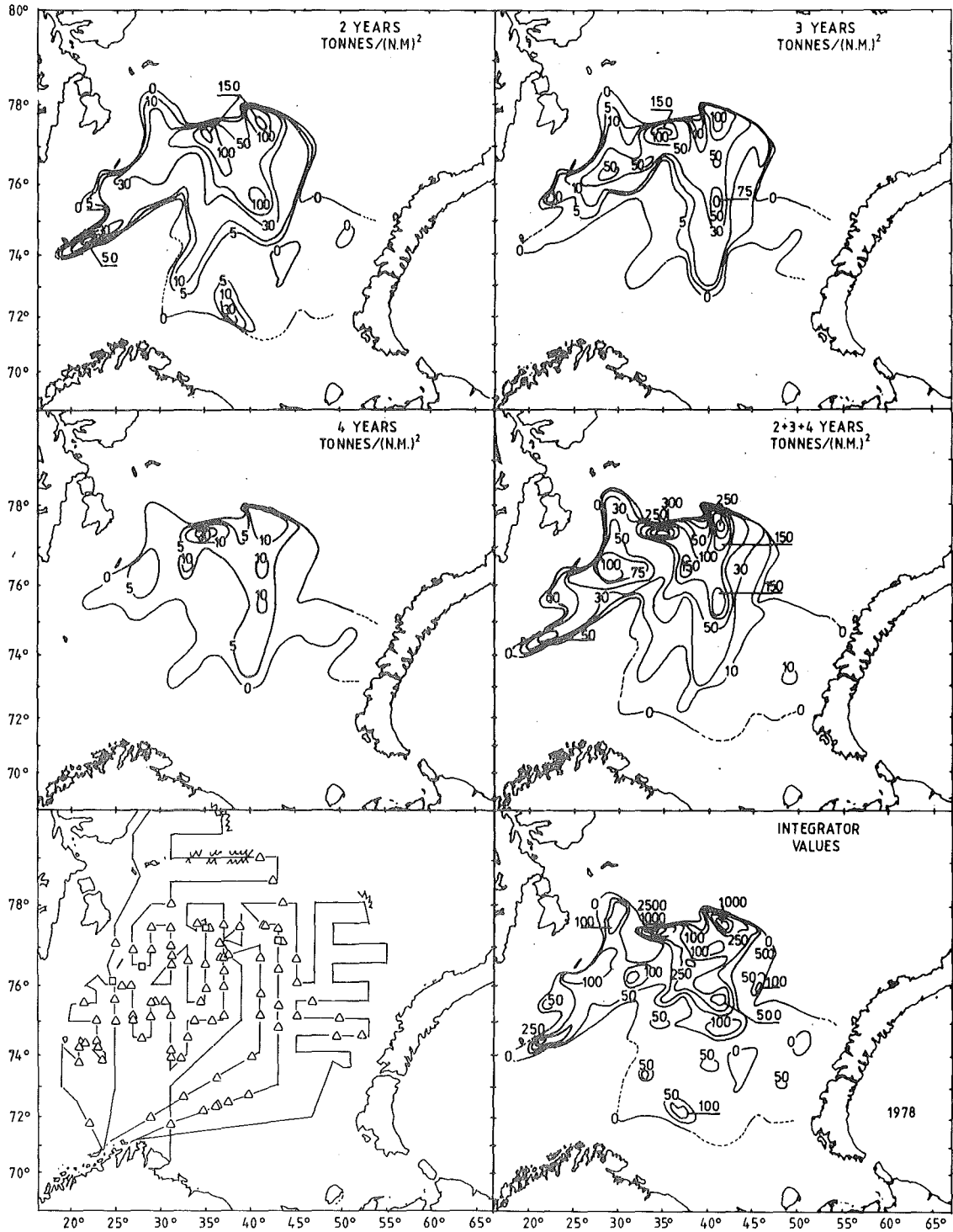


Figure 13. Calculated biomass distribution for 2-, 3- and 4-year-old capelin in 1978, total biomass distribution for 2-year-olds and older capelin, cruise track during the survey, and distribution of integrator values. Legend as in Figure 7.

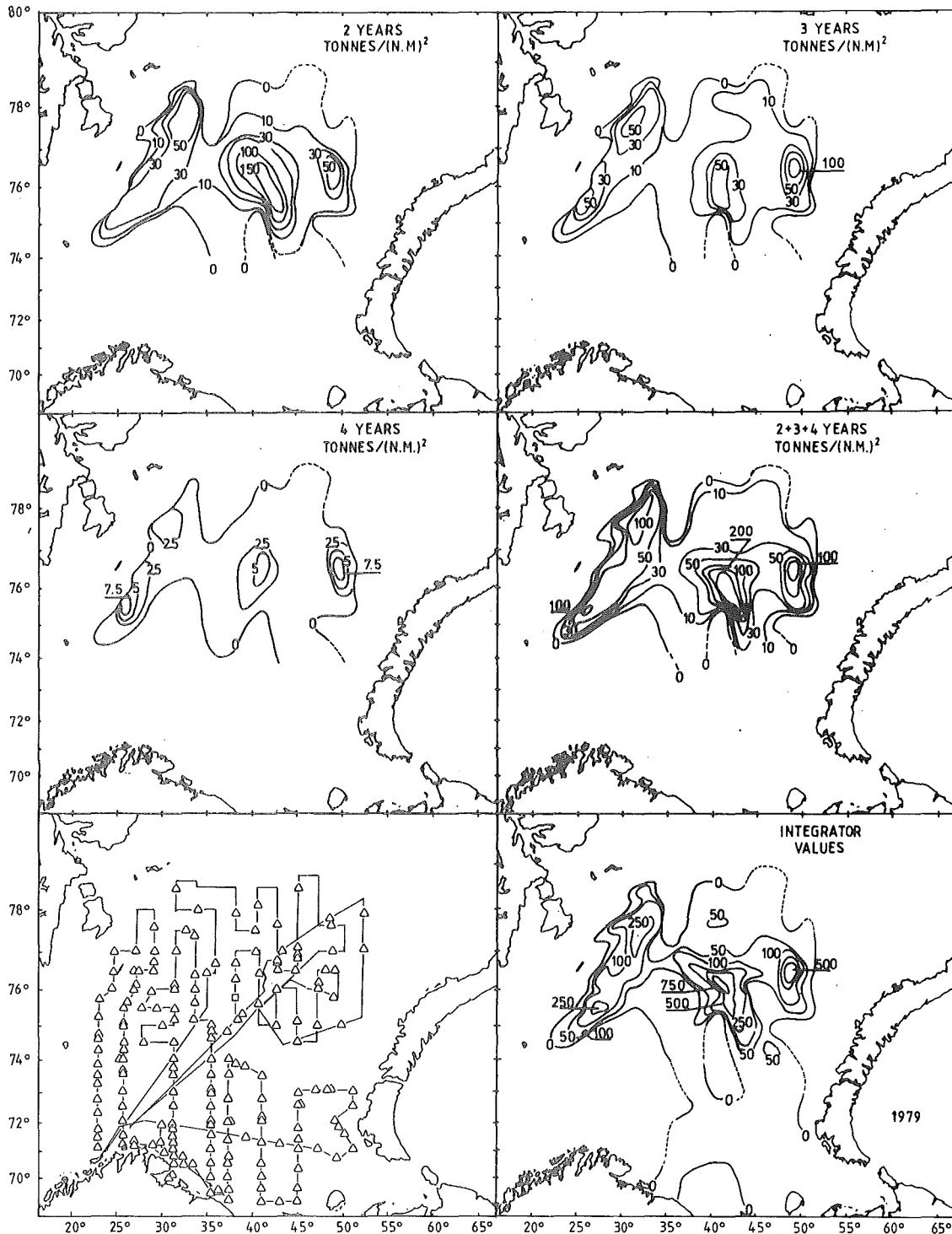


Figure 14. Calculated biomass distribution for 2-, 3- and 4-year-old capelin in 1979, total biomass distribution for 2-year-olds and older capelin, cruise track during the survey, and distribution of integrator values. Legend as in Figure 7.

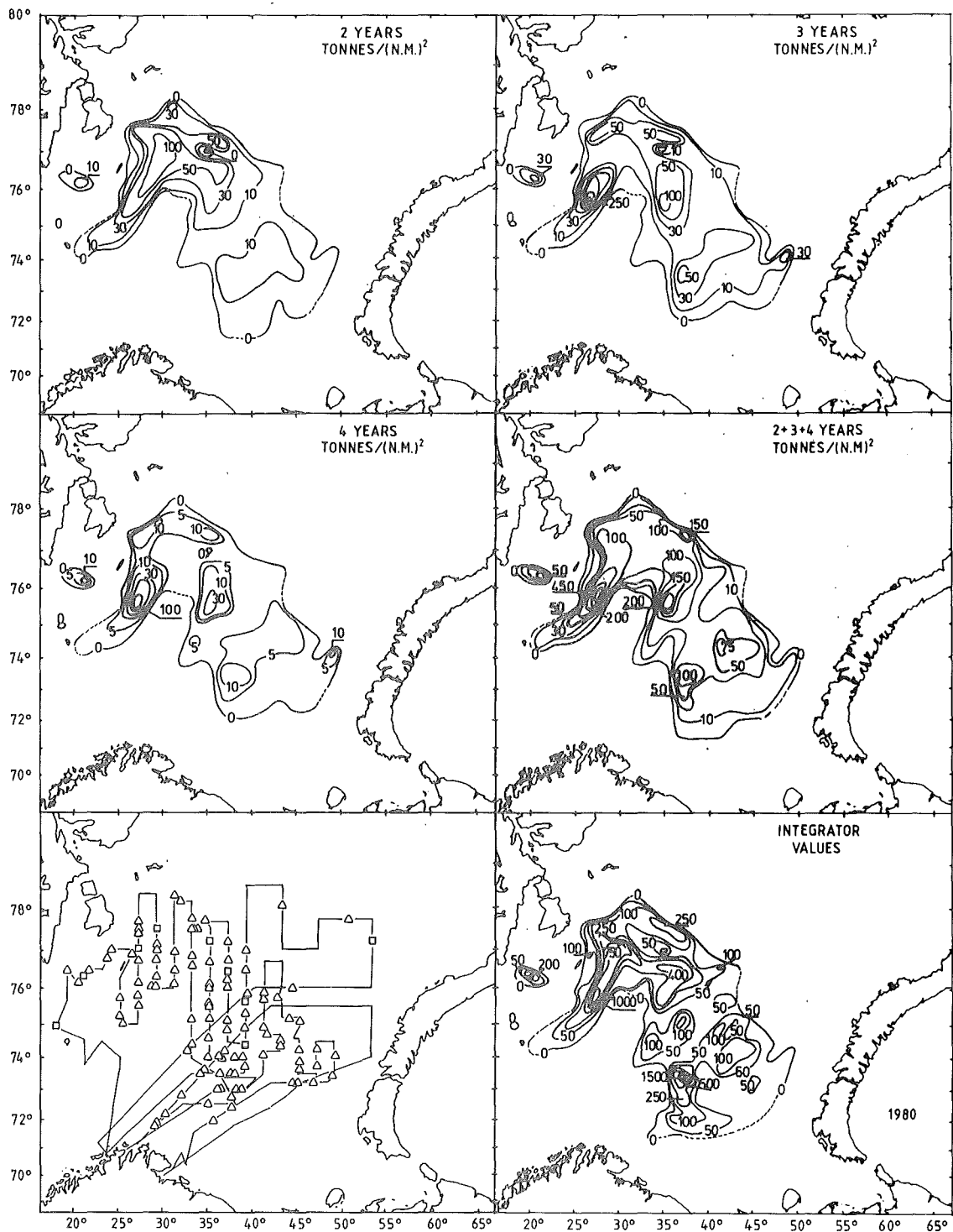


Figure 15. Calculated biomass distribution for 2-, 3- and 4-year-old capelin in 1980, total biomass distribution for 2-year-olds and older capelin, cruise track during the survey, and distribution of integrator values. Legend as in Figure 7.

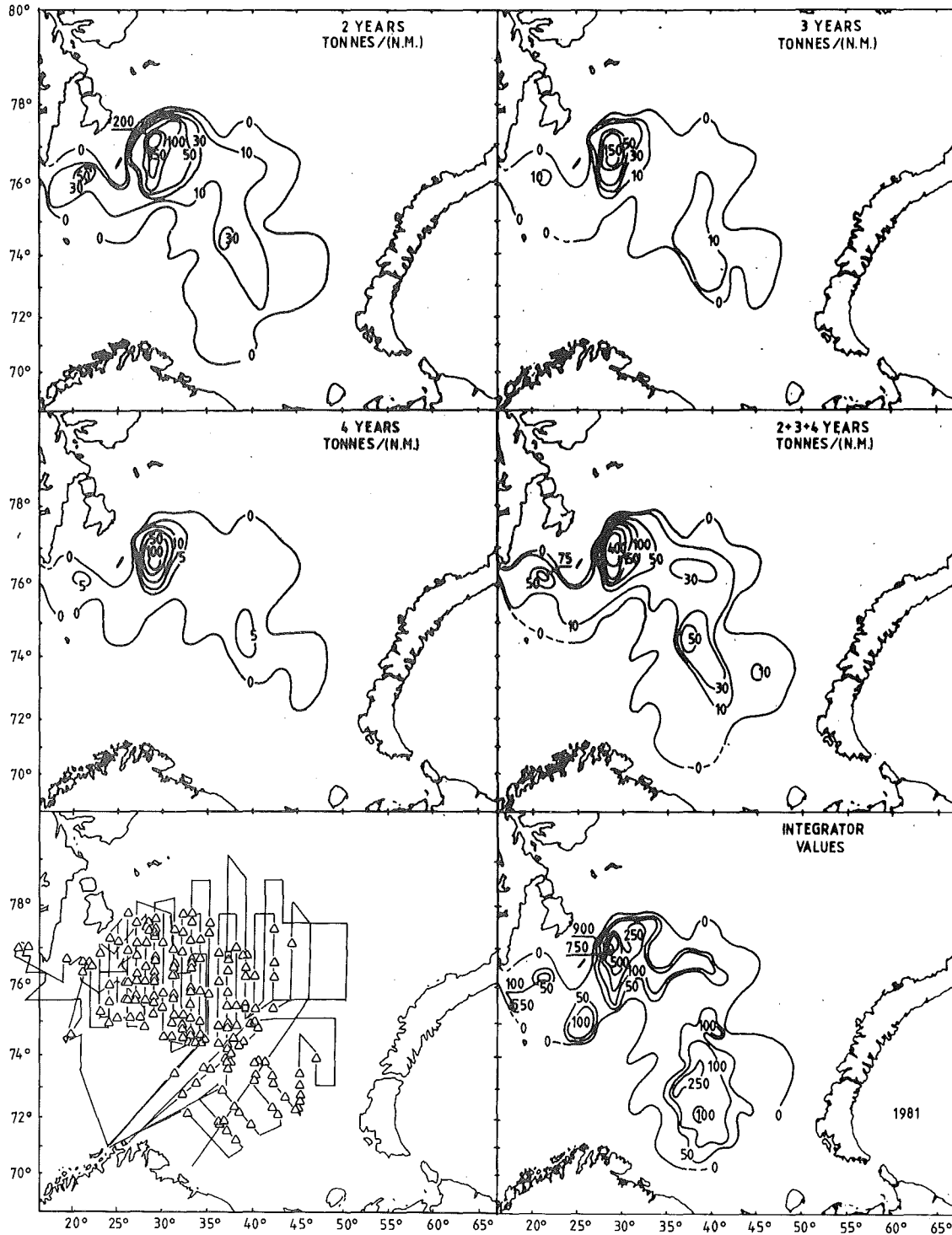


Figure 16. Calculated biomass distribution for 2-, 3- and 4-year-old capelin in 1981, total biomass distribution for 2-year-olds and older capelin, cruise track during the survey, and distribution of integrator values. Legend as in Figure 7.

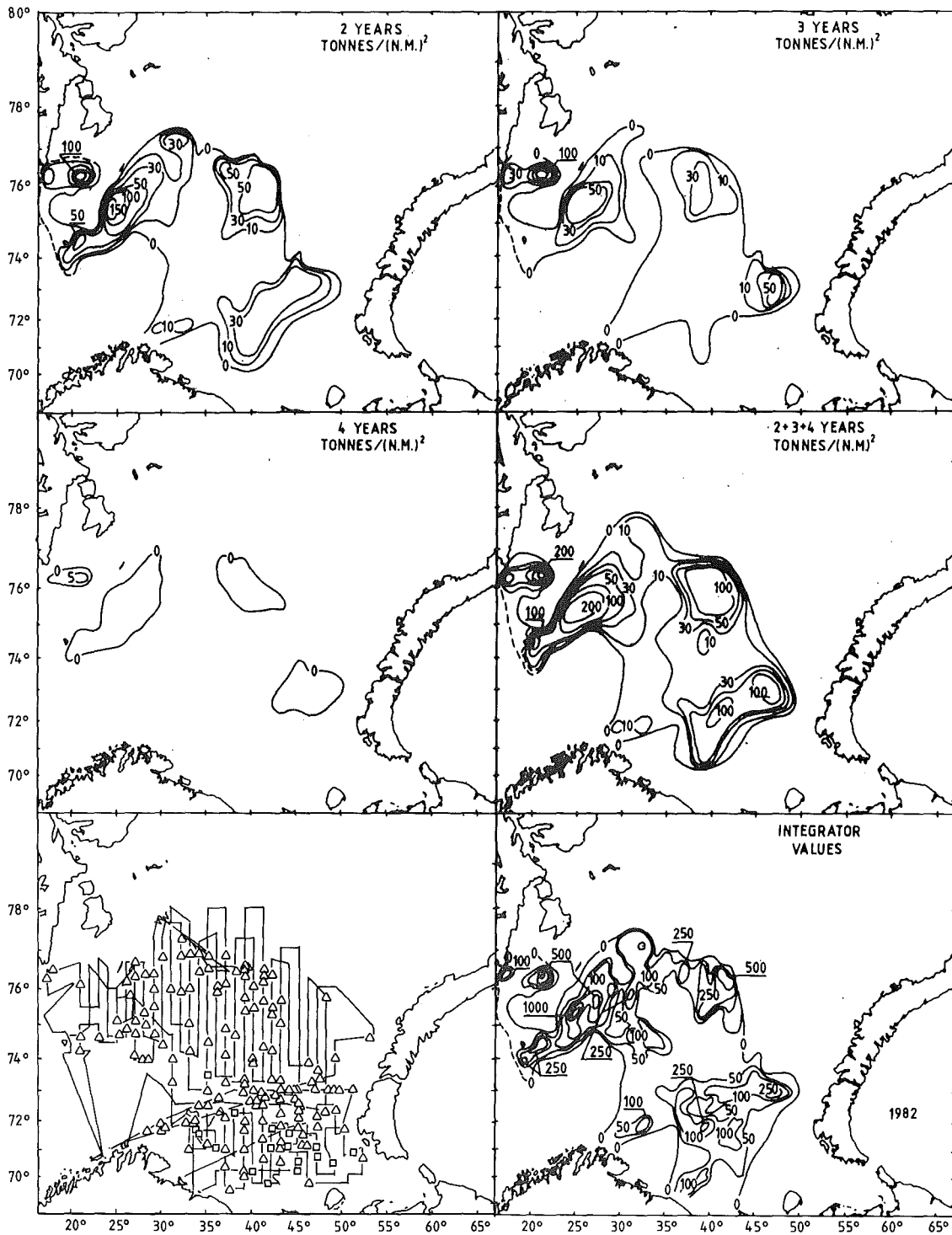


Figure 17. Calculated biomass distribution for 2-, 3- and 4-year-old capelin in 1982, total biomass distribution for 2-year-olds and older capelin, cruise track during the survey, and distribution of integrator values. Legend as in Figure 7.



Figure 18. Calculated biomass distribution for 2-, 3- and 4-year-old capelin in 1983, total biomass distribution for 2-year-olds and older capelin, cruise track during the survey, and distribution of integrator values. Legend as in Figure 7.

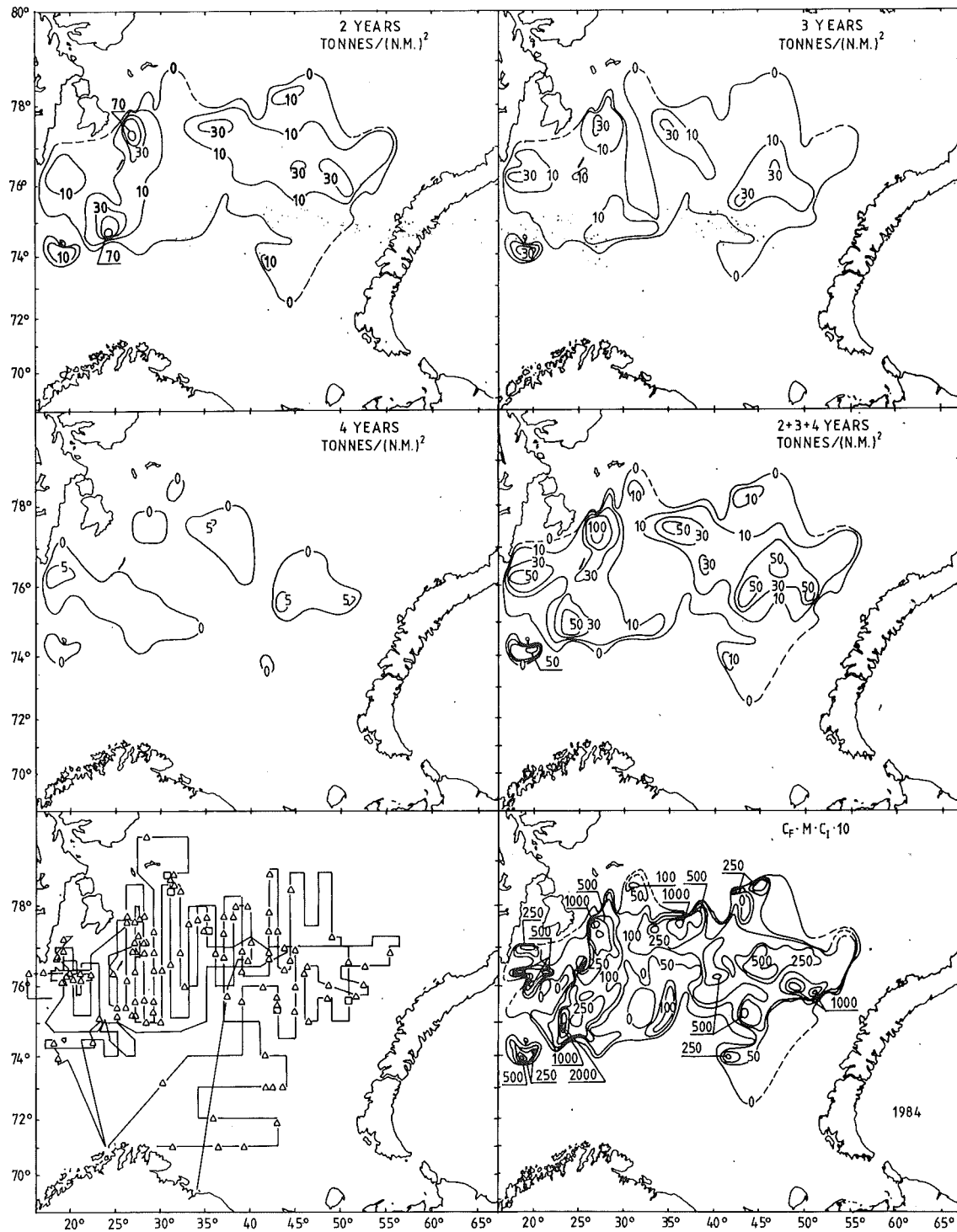


Figure 19. Calculated biomass distribution for 2-, 3- and 4-year-old capelin in 1984, total biomass distribution for 2-year-olds and older capelin, cruise track during the survey, and distribution of integrator values. Legend as in Figure 7.

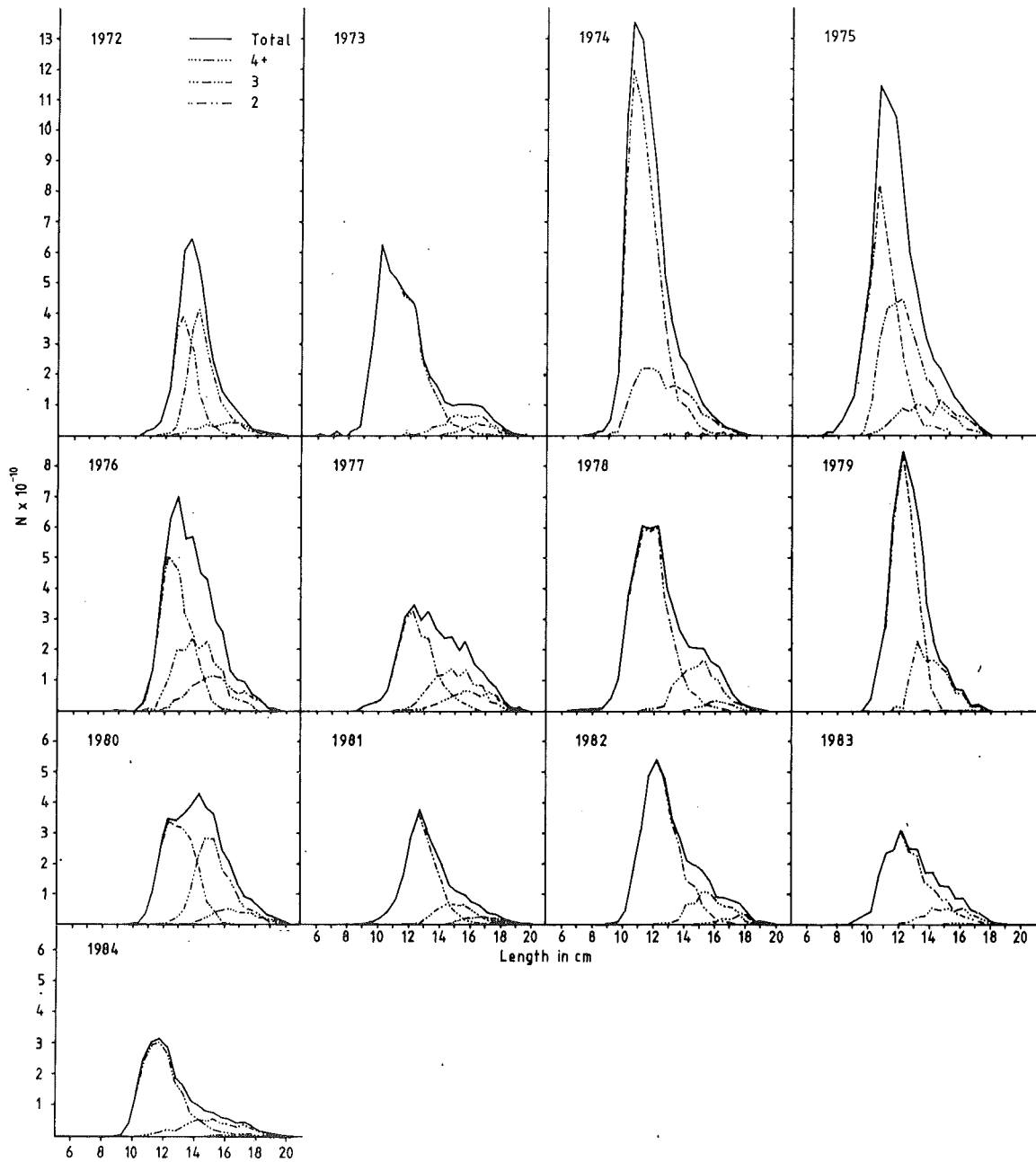


Figure 20. Length distribution of Barents Sea capelin per age-group and total, for the years 1972-1984.

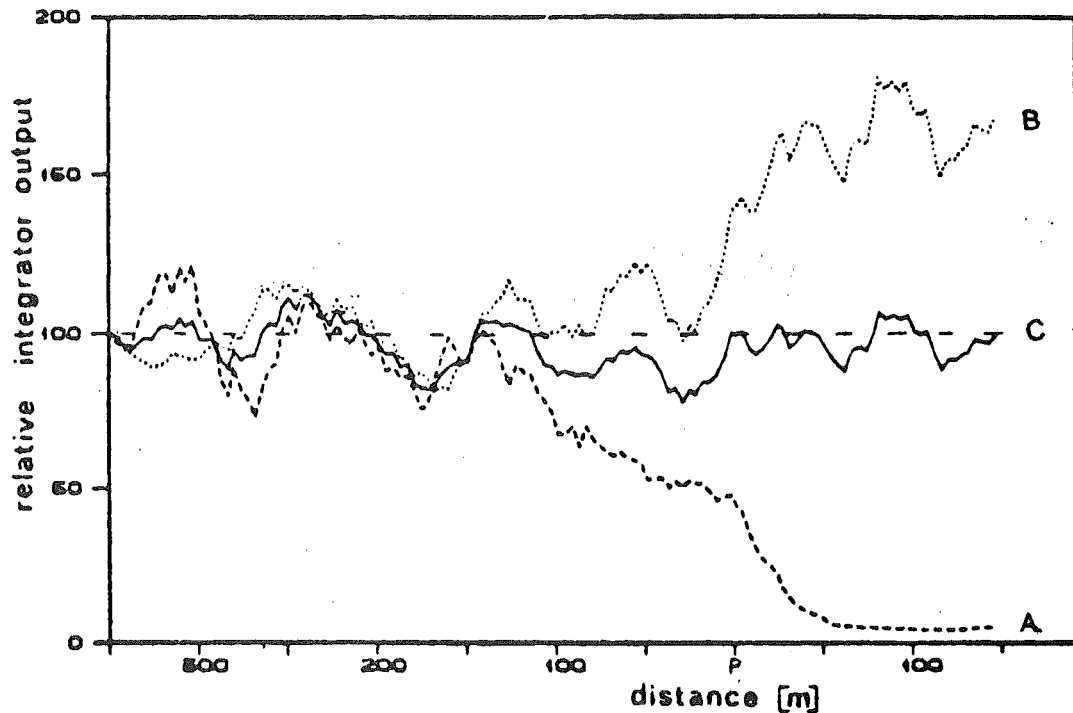


Figure 21. Relative echo integrator output (running mean per transmission), computed from echo recordings obtained using a submerged transducer (Olsen et al. 1983).

- A: Capelin, $\bar{l}=14$ cm, at 112 - 132m depth at night during vessel passage (p), (R/V "G.O. Sars", 12 knots).
- B: Capelin, $\bar{l}=14$ cm, at 132 - 172 m depth in the same run.
- C: Sum of A and B.

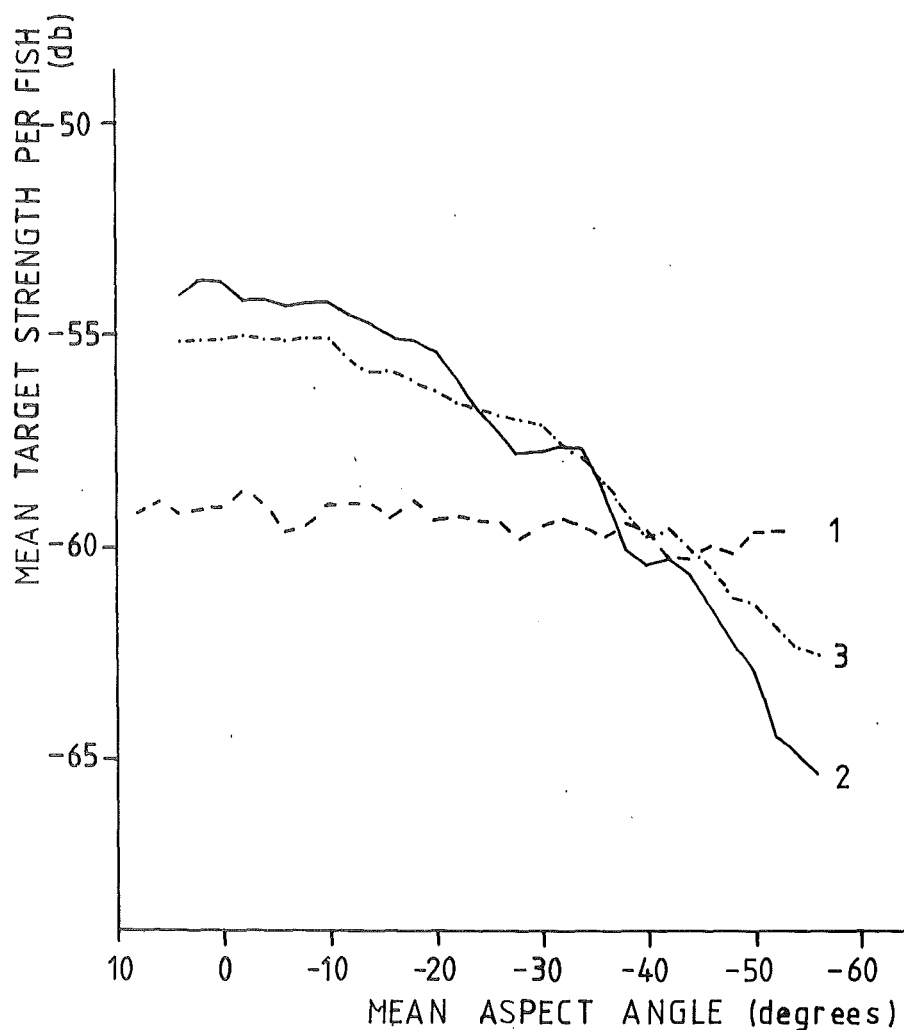


Figure 22. Target strength as a function of mean aspect angle for different fish distributions. (Angell, 1983).

Curve 1. 40 capelin unoriented. Density at 0 aspect angle: 350 specimens/m³.

Curve 2. 40 capelin systematically oriented. Density at 0 aspect angle: 1700 specimens/m³.

Curve 3. 73 capelin systematically oriented. Density at 0 aspect angle: 1700 specimen/m³.

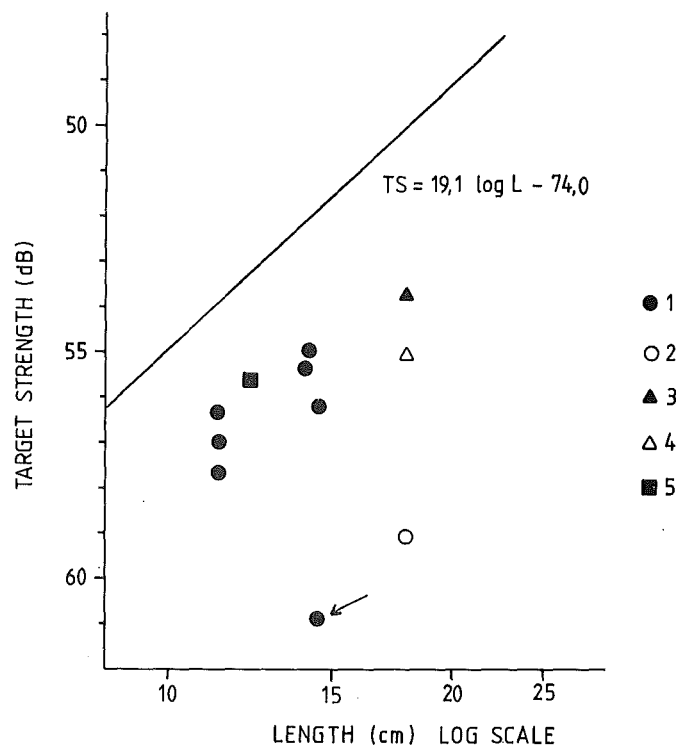


Figure 23. Results from target strength measurements on capelin.

- 1: In situ measurements at Iceland. Halldorson and Røyneisson (1983). Arrow shows measurement when deck lights were switched on.
 - 2: Measurement of capelin in cage. Mean aspect angle 0° , fish not systematically oriented. (Angell 1983).
 - 3: Measurement of capelin in cage. Mean aspect angle 0° , 40 fish systematically oriented. (Angell 1983).
 - 4: Measurement of capelin in cage. Mean aspect angle 0° , 73 fish systematically oriented. (Angell 1983).
 - 5: Target strength measured by counting echo traces September 1981. (Angell 1983).
- $TS = 19.1 \log L - 74.0$ is the target strength applied during the autumn capelin survey in the Barents Sea.



Figure 24. The distribution of the 0°C and the 2°C isotherms in 100 m depth and the distribution of capelin in the period 1974 - 1983. The main areas of concentration are hatched.

APPENDIX I

NEW INSTRUMENT CONSTANTS FOR ECHO INTEGRATION IN USE AT THE INSTITUTE OF MARINE RESEARCH, BERGEN FROM 15 JULY 1985.

In this paper we have used the definition of target strength given by Dalen and Nakken (1983):

$$TS = 10 \log \sigma$$

However, a more commonly used definition (see for example Johannesson and Mitson, 1983):

$$TS = 10 \log \sigma / 4\pi$$

It has been decided that the above definition of target strength shall be used in reports and publications from the Institute of Marine Research with effect from 15 July 1985.

This affects many of the formulas in this paper. In particular, it leads to changes in the levels for C_F and C_I . C_I has been incorporated into the integrator values in order to make them system independent - together with a factor of 10, to avoid decimals. The factor of 10 was dropped from 15 August 1985, so that instead of 4π we have to introduce a factor of $4\pi/10$:

$$C_{F_{new}} = C_{F_{old}} \cdot 10 / 4\pi$$

$$C_{I_{new}} = C_{I_{old}} \cdot 4\pi / 10$$

For the system conversion constant and the calculated stock this makes no difference, as we have:

$$C = C_{I_{old}} \cdot C_{F_{old}} = C_{I_{new}} \cdot C_{F_{new}}$$

However, the change does make a difference for the integrator values that are output from the integrator systems onboard the institute's research vessels, because $C_{I_{old}} \cdot 10$ was incorporated in the values before 15 July 1985 and $C_{I_{new}}$ was incorporated after that date.

Therefore, if we compare "new" and "old" integrator values, we have:

$$M_{new} = M_{old} \cdot 4\pi / 10$$

This will of course also apply to comparisons of "integrator charts" based on "old" and "new" integrator values.

For the system conversion constant the relationship will be:

$$C_{new} = C_{old} \cdot 10 / 4\pi$$

APPENDIX II

ACOUSTIC ESTIMATES, FLOW CHART FOR THE RECORDING OF DATA AND CALCULATION OF STOCK SIZE. Adapted from Dommasnes, 1979.

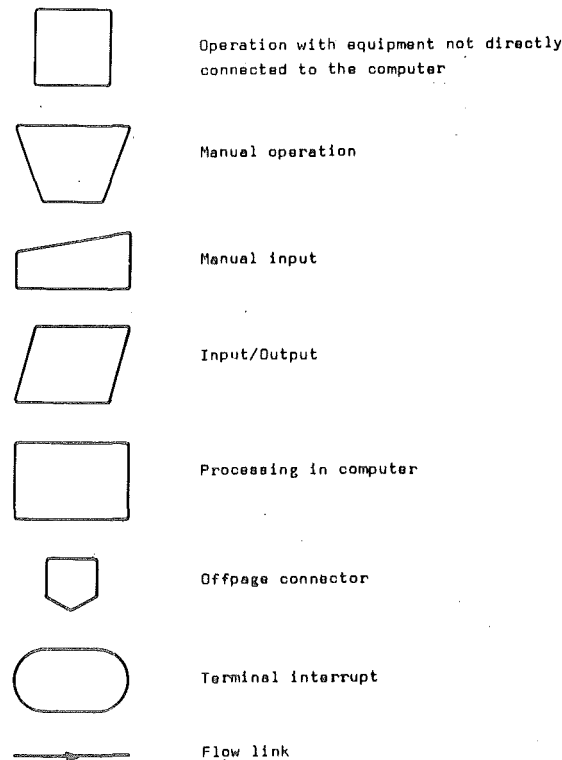
The calculations are based on a division of the total area in which the stock is to be assessed into numerous smaller areas, which here have been called "squares". The size of the squares should probably be no more than 60 x 60 nautical miles, preferably smaller, depending on the size of the total area.

The total area is also divided into 4-6 subareas in which biological characteristics like length-age and length-weight relations are assumed to be fairly uniform. The subareas are defined by the squares that are included in them.

The calculations are thus carried out and presented on three geographical levels: squares, subareas and total area.

All calculations are based on length groups.

The following symbols have been used in the flowchart:



SYNOPSIS OF THE METHOD OF BIOACOUSTIC STOCK MEASUREMENTS.

(The numbers refer to the numbers on the flow chart).

1. The echo sounder must have an output for the integrator, and the echo sounder-transducer combination must be properly calibrated.
2. Each signal is squared, and then integrated. This can be done by an analog integrator or by a digital computer.
3. Echo densities integrated over five nautical miles are printed out by the computer (or recorded manually) for several depth intervals.
4. Echoes are also recorded on echosounder paper. Recording intensity should be adjusted so that the weakest signal recorded on paper is also the weakest signal integrated.
5. Sampling is done by trawl. Ideally, the selectivity of the trawl should be known or there should be no selectivity.
- 6- The catch is sorted by species. For each species a random sample
7- is taken, and length, weight, age, and other biological
8. characteristics are recorded for each fish in the sample on special forms for punching, and entered into the computer.
9. To eliminate errors as far as possible, the sample data are run through a test program that picks out improbable or impossible data and allows those to be corrected.
10. Key data from each sample are tabulated by the computer and printed out.
- 11- Key data are plotted manually on charts to allow evaluation of
12- geographical distribution of biological characteristics. On the
13. basis of this evaluation, subareas are defined inside which the same length-age and length-weight keys can be used. The subareas are defined in the computer by listing the squares that are included.
14. The integrated echo densities are compared with the echosounder paper for each five nautical miles, and corrections are made for "false signals" (mainly bottom signals or wave noise).
15. The mean integrated echo density per nautical mile (M) in each square is calculated manually as the sum of all corrected integrated densities divided by the number of nautical miles sailed in the square.
16. Integrated echo intensities are entered into the computer as a mean value for each square.
- 17- Based on the echosounder paper and the samples, a decision is
18. made on which sampling stations can be considered representative for the kinds of recordings found in each square. Sampling stations from neighbouring squares may also be used. The decision is entered into the computer as a list of samples for each square.

19. The length frequency (p_i) for each square is calculated from the samples assigned to that square, giving each sample entry equal weight.
20. C_I , C_S and b have been obtained empirically.
21. The area of each square is entered into the computer.
22. The number of fish in each length group is calculated for each square according to the formula;

$$N_i = (C_I \cdot M) \cdot \frac{p_i}{\sum_{i=1}^n \frac{p_i}{C_{F_i}}} \cdot A$$

N_i = the number of capelin in length group i in the square.

C_I = the instrument constant.

M = the average integrator value calculated for the square.

p_i = the proportion that the capelin in length group i makes up of the total number of capelin in all the length groups ($\sum p_i = 1$).

$C_{F_i} = C_S \cdot l_i^{-b}$ where l_i is the (arithmetic) middle length in the length group i and C_S and b have been determined empirically.

A = the area in square nautical miles.

23. Biological characteristics other than length-age and length-weight relationships are presented in tables for each subarea, and printed out. The tables are compiled by adding relevant information from all samples in the subarea.
- 24- Length-age and length-weight tables are compiled for each square
25. by adding the relevant information from all sampling stations assigned to that square.
- 26- Length-age and length-weight tables for each square are combined
27. to give corresponding tables for the subareas, and printed out.
- 28- While lengths are recorded for all fish sampled, ages and weights
- 29- may be recorded from some of the samples only. It is therefore
- 30- possible that the length-age and length-weight keys will not
31. cover the extremes of the length range in question. It is therefore necessary to check whether the length-age and length-weight tables cover the necessary range and, if necessary, fill in approximate values for missing parts of the tables. The additions are entered into the computer.
32. Total number of fish in each age group in each square is obtained by combining the total number at length in the square with the length-age key for the subarea. The number of fish in each age group is printed out.
- 33- Total number of fish in each age group in each subarea is
34. obtained by adding the numbers from all squares in that subarea. The numbers are printed out.

- 35- Total number of fish in each age-group in the total area is
36. obtained by adding the numbers from all subareas. The numbers are printed out.

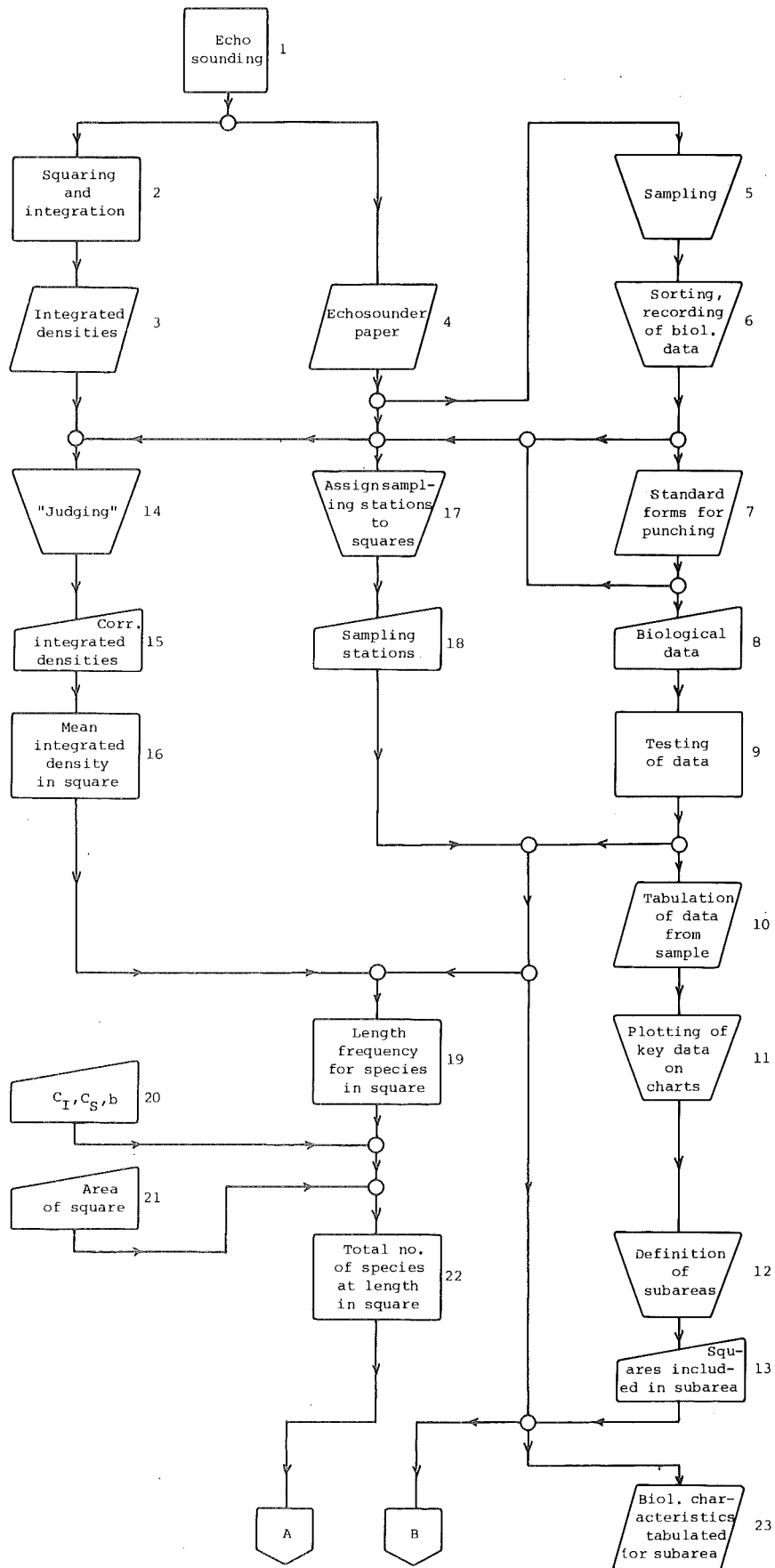
37. Total weight of fish in each age-group in each square is obtained by combining the total number at length in each square with the length-age and length-weight keys for the subarea. The weights are printed out.

- 38- Total weight of fish in each age group in each subarea is
39. obtained by adding the numbers from all squares in that subarea. The weights are printed out.

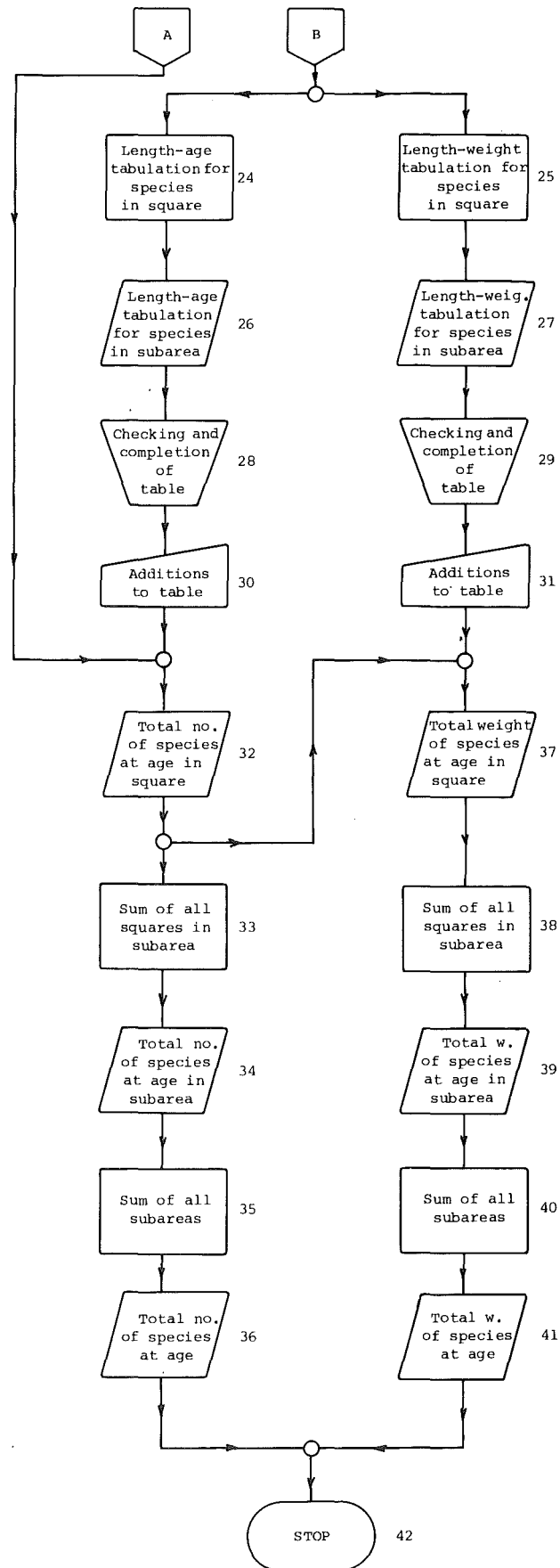
- 40- Total weight of fish in each age group in the whole area is
41. obtained by adding the numbers from all subareas. The weights are printed out.

42. End of the program.

FLOW CHART FOR THE RECORDING OF DATA



FLOW CHART FOR THE RECORDING OF DATA continued



ON METHODS OF BIOLOGICAL STUDIES OF THE BARENTS SEA CAPELIN.

by

E.I. Seliverstova and V.N. Shleinik

Polar Research Institute of Marine Fisheries and Oceanography (PINRO),
6 Knipovich Street,
183763 Murmansk,
USSR.

ABSTRACT

A complete biological analysis of the Barents Sea capelin, carried out by the PINRO specialists, is presented in detail. A method of determining capelin age by otoliths and a form for collection of data are also given.

1. INTRODUCTION

Rationalizing the capelin fishery is the main objective of the Soviet and Norwegian vessels in recent years, and demands permanent monitoring of stock conditions. Sampling is conducted throughout the year to determine the length-age composition of catches, the feeding, maturation, abundance and biomass of the population, and finally to determine the size of the annual harvest. A method for the collection and processing of such samples is given in the present paper.

2. MATERIALS AND METHODS

Samples are taken onboard and measurements recorded on a special form (Appendix 1), which includes the following data: date of catch, name of the vessel, positions of fishing, station number, fishing gear and area code. The fork length and total length of approximately 300 fish are measured to within 0.1 cm. A subsample of 100 fish is weighted to within 0.1 g, and sex, maturity stage, degree of stomach fullness and the main food objects are determined by dissection.

A maturation scale for capelin males and females was developed to replace the inadequate "cod scale" initially used at PINRO (Oganesyan 1984). Qualitative and quantitative signs for relatively fast and accurate estimation of the condition of the gonads were described (Table 1 and 2).

Sex of fish up to 5 cm long is visually indistinguishable. It is possible to distinguish females by maturity stage I, when the folds of the egg-carrying plates are well pronounced on the surface of the gonads and the ovaries form thin cords, colourless or pink, and transparent. This stage is observed for immature capelin females of a length less than 11 cm and at age 1-4 years. Ovaries have a similar appearance in both stage II immature and stage VI-II postspawning females (Oganesyan 1984). Distinguishing immature females in the beginning of maturity stage III is difficult because of the lack of well-pronounced external differences. However, accurate determination of the onset of stage III in summer-autumn is important when the next year's spawning stock is estimated.

The diameter of the oocytes correctly identifies maturing females. 15-20 eggs from the middle of the ovary of females over 10 cm long are measured using a binocular microscope or magnifying glass with a ruler. If the diameter of oocytes exceeds 0.15 mm then stage III has started in the ovaries and the specimens should be classified with the maturing part of the stock (Oganesyan 1984). Initial stages of male maturation are easily recognized. In the autumn, (September-October), there are no difficulties in determining the stage III for males. In June-August, however, the males in this maturation stage are often considered to be immature, even though a notable percentage starts to mature already during a feeding migration in summer.

Table 1. Macroscopic characteristics of the maturity stage of the ovaries.

| Maturity stage | Weight of gonads, g | Coeff. of maturity, % | Diameter of oocytes, mm | Characteristic signs |
|-------------------------|--------------------------|--------------------------|--|--|
| II | <u>0.03-0.06</u> 0.04 | <u>0.3-0.9</u> 0.5 | 0.015-0.15 | Gonads colourless or creamy-pink, transparent, dense; eggs translucent, superficially indiscernible |
| III July- August | <u>0.04-0.36</u> 0.15 | <u>0.3-2.2</u> 1.3 | 0.14-0.22 | Gonads colourless or creamy-gray with pink hue, transparent, dense; eggs translucent. |
| III Sept- October | <u>0.06-0.67</u> 0.36 | <u>0.5-3.1</u> 1.8 | 0.18-0.40 | |
| III Nov- December | <u>0.5-1.5</u> 0.9 | <u>2.7-5.0</u> 3.8 | 0.35-0.50 | Gonads light-yellow, opaque, dense; eggs becoming opaque, visual, hardly separable from the stroma. |
| IV | <u>1.9-3.3</u> 2.5 | <u>13.4-20.4</u> 16.7 | 0.65-0.93 | Gonads yellow or orange, opaque, dense; eggs relatively separable from the stroma. |
| V | <u>2.6-6.5</u> 3.7 | <u>19.6-32.0</u> 23.8 | 0.87-1.07 | Gonads yellow, opaque, soft; eggs translucent lying loosely in the body cavity, "spill", flow out easily in a continuous spurt with a weak rubbing of abdomen. |
| VI | <u>0.06-0.26</u> 0.13 | <u>0.5-1.8</u> 1.1 | Oocytes of protoplasm. growth up to 0.13 mm. | Gonads white or colourless, translucent, flaccid, watery; growing dense for 1.5-2 months after spawning. |
| VI-II | <u>0.07-0.34</u> 0.14 | <u>0.5-1.7</u> 1.0 | 0.16-0.30 | Gonads colourless, translucent, dense. |

Here and in Table 2: limits of variations are given in the numerator, mean values in the denominator.

Table 2. Macroscopic characteristics of the maturity stages of testes.

| Maturity stage | Weight of gonads, g. | Coeff of maturity, % | Colour, transparency and density of gonads | Spermatozoa availability |
|-------------------------|--------------------------|--------------------------|---|---|
| II | <u>0.03-1.12</u> 0.06 | <u>0.1-0.4</u> 0.2 | Creamy, with a pink hue, opaque, dense. | No spermatozoa. |
| III July- August- | <u>0.06-.025</u> 0.14 | <u>0.3-0.9</u> 0.7 | Light grey, occasionally with yellow or pink hue; opaque dense. | No spermatozoa at the beginning of the stage. In the second half of the stage (from December-January) the excretory duct is expanded and contains spermatozoa. Testes become slightly milky in the cut, but its edge do not swell up. A drop of sperm secrets of the excretory duct. |
| III Sept- October | <u>0.09-0.50</u> 0.3 | <u>0.4-1.7</u> 1.14 | | |
| III Nov- December | <u>0.28-1.00</u> 0.55 | <u>0.8-2.7</u> 1.8 | White, the surface of the testes has a net-like pattern, opaque, dense. | |
| III Jan- February | <u>0.20-1.40</u> 0.6 | <u>0.7-4.6</u> 2.0 | | |
| IV | <u>0.25-0.75</u> 0.41 | <u>1.1-1.2</u> 1.5 | Milky-white; opaque averagely dense. | With rubbing of the abdomen a great amount of thick sperm is excreted. Edges of the cut swell up. |
| V | Decreases | gradually | First milky-white, growing irregularly brown, translucent, soft. | With a slight pressing of the abdomen thin sperm flows out easily. The cut of the testes becomes heavily milky. |
| V-VI VI | <u>0.06-0.26</u> 0.13 | <u>0.36-1.2</u> 0.7 | Dirty-grey with a brownish hue; translucent, flaccid. | Being half extruded the sperm flows out with a slight rubbing of the abdomen. Complete extrusion is characterised by the ceased secretion of spermatozoa. |
| VI-II | <u>0.03-0.06</u> 0.04 | <u>0.13-0.35</u> 0.23 | Creamy with a yellowish hue; opaque, averagely dense. | An insignificant amount of spermatozoa remains occasionally in the excretory duct. |

A proper estimation of the state of the testes in spring and summer in the coastal sea areas when maturity stages III, IV and V are simultaneously available, is of great importance. The density of gonads, the availability of spermatozoa in the excretory duct and in the incision into the testis, and the character of spermatozoa secretion are the main criteria in determining the stages of maturation. The physiological condition of the males in spring-summer is a good indicator of the spawning ground locations and spawning stage (Oganesyan 1984).

3. RESULTS

Scientists of PINRO and Bergen Institute of Marine Research use different methods to measure length and weight of capelin: specialists of the Polar Institute measure the length up to the ends of the middle rays of the tail fin (Smitt's, or fork length, L_s) whereas the Norwegian colleagues measure the full length of the fish (L_f). The difference was first noted during joint investigations in the Barents Sea, and it was written in the 1979 report. From correlation, the relationship between the full and the fork length may be expressed by the regression equation:

$$L_f = 1.08 \times L_s$$

Soviet specialists now make measurements of the absolute length of fish to obtain comparable data, especially during acoustic surveys to assess the capelin stock in the autumn.

The PINRO workers obtain the average weight of length groups of capelin by using two methods:

1. by the weight of every fish taken for complete biological analysis (100 species)
2. by the average weight of the fish of a given length group.

The applied methods give rather comparable results, for use during joint investigations.

In PINRO the age of capelin is being determined by otoliths immersed in glycerine under incident light at magnification 8x2 (Prokhorov 1963). (Those raising doubts are conducted at reduced magnification, i.e. 8x1 or 8x0.6). Age determination is by annuli and otoliths are measured along line C-D (Fig 1) using a binocular micrometer.

If a disputable ring is distinct on the reverse side under various magnifications, then it is considered to be an annulus. Additional rings, (indistinct or not visible around the whole otolith) appears after the spring of the second year of life.

When ageing otolith samples, determining the central (first) or the last annuli is problematic.

If the first zone of growth is very small and becomes a dot when the magnification is lowered or if this zone is observed in only one of the otoliths, age is difficult to ascertain

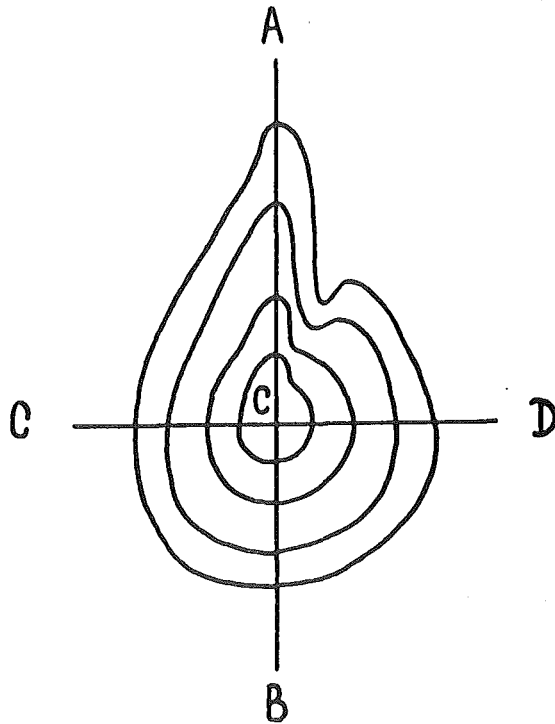


Fig. 1. Direction of capelin otolith measurements.

In the second case, characteristic for older fish, doubts emerge when dealing with annuli which are incomplete or which have a very small zone of growth.

Four Norwegian samples have been analysed to compare the methods used by the Polar Institute and IMR to determine the age of the Barents Sea capelin. (see also the report of the otolith workshop in section IV).

Age determination, carried out independently by 4 PINRO scientists, gave encouraging results. Thus, in Sample 1 (17 January 1983) the agreement in age determination constituted 92%, in Sample 2 (18 January 1983) - 95%, in Sample 3 (2 September 1983) - 91.5% and in Sample 4 (3 September 1983) - 96%.

Different opinions in determining the first annulus arose in Sample 1 (four times), Sample 2 (one time), Sample 3 (five times) and Sample 4 (two times).

Difficulties in determining the last annulus was observed in Sample 1 (seven times) and Sample 3 (four times).

When the difficulties of ageing capelin by otoliths are taken into account, the methods used by the Polar Institute specialists appears to us to be preferable. The Norwegian procedure of fixing otoliths in a hard mounting medium, has the advantage of convenience of storage

and ease of preparation to read, although it becomes impossible to turn the otolith when in doubt.

4. REFERENCES

- Oganesyan, S.A. 1984. Manual for determination of gonad maturity stages of the Barents Sea capelin. Murmansk, PINRO: 24p.
- Prokhorov, V.S. 1963. Some features of the capelin ecology (Mallotus villosus villosus Müller) in the Barents Sea. Trudy PINRO, 15:163-176 (In Russian).

Appendix I

The form used in connection with fish biological analysis (appendix Fig 1) is filled in with the data obtained in a cruise.

The top of the form is filled in with the following data:

| Position | | Content |
|----------|---|--------------------------------------|
| 2 - 5 | - | number of the document |
| 6 - 8 | - | number of the haul |
| 9 - 14 | - | date (year, month, day) |
| 15 - 18 | - | gear |
| 19 - 26 | - | code of the object |
| 27 - 28 | - | total/Smitt's length of fish (coded) |
| 29 - 30 | - | number of maturity stage codifier |
| 31 - 41 | - | coordinates |
| 42 - 49 | - | code of the area |
| 50 - 51 | - | number of lines filled in |
| 52 - 55 | - | call sign, ship, cruise |

The other part of the form is filled in with the data of the fish biological analysis:

| Position | | Content |
|----------|---|--------------------------------|
| 1 - 3 | - | Numbers of lines |
| 4 - 6 | - | Number of specimens |
| 7 - 10 | - | zoological length, (mm) |
| 11 - 14 | - | Smitt's length, (mm) |
| 15 - 20 | - | total weight, (g) |
| 21 | - | sex |
| 22 - 23 | - | maturity stage |
| 24 | - | stomach fullness |
| 25 - 27 | - | age |
| 28 | - | fatness |
| 29 - 33 | - | weight of liver, (0,1 g) |
| 34 - 38 | - | weight of food bolus, (0,1 g) |
| 39 - 43 | - | weight of gonads, (0,1 g) |
| 44 - 49 | - | weight of gutted fish, (0,1 g) |
| 50 - 51 | - | number of spawning rings |
| 52 - 53 | - | age of the first spawning ring |
| 54 - 68 | - | coded primary food object |

Ф15 КАРТОЧКА БИОЛОГИЧЕСКОГО АНАЛИЗА РЫБ

| 1 | НОМЕР ДОКУМ. | | НОМЕР ЛОВА | | ДАТА | | | | ОРУДИЕ ЛОВА | | КОД ОБЪЕКТА | | | | L/ℓ | МОДУЛЬ РАСТВОРА | КООРДИНАТЫ МЕСТА | | | | | | | | КОД РАЙОНА | | | | КОД СТРОК | КОД КВАДРАТА | | ПОЗЫВНОЙ, СУДНО, РЕЙС |
|---|--------------|---|------------|---|------|----|----|----|-------------|----|-------------|----|----|----|-----|-----------------|------------------|----|----|----|----|----|----|----|------------|----|----|----|-----------|--------------|--|-----------------------|
| | 3 | 5 | 7 | 9 | 11 | 13 | 15 | 17 | 19 | 21 | 23 | 25 | 27 | 29 | 31 | | 33 | 35 | 37 | 39 | 41 | 43 | 45 | 47 | 49 | 51 | 53 | 55 | | | | |
| 1 | | | | | | | | | | | | | | | | | | | | | | | | | | | | | | | | |

| НОМЕР ОСОБИ | ДЛИНА (мм) | | | | МАССА ОБЩАЯ (г) | ПОЛ | СТАДИЯ ЗРЕЛОСТИ | НАПОЛНЕНИЕ ПЕЧЕНИ | ВОЗРАСТ | ЖИРНОСТЬ | МАССА ПЕЧЕНИ 0,1г | МАССА ПИЩЕВОГО КОМКА 0,1г | МАССА ГОНАД 0,1г | МАССА БЕЗ ВНУТРЕННОСТЕЙ 0,1г | КОД ЧИСЛА ХВОСТА | КОД ЧИСЛА ПОДЖЕЛУДКА | ОСНОВНЫЕ ОБЪЕКТЫ ПИТАНИЯ | | | | | | | | | | | | | | | | | | | | |
|-------------|------------|---|---|---|-----------------|-----|-----------------|-------------------|---------|----------|-------------------|---------------------------|------------------|------------------------------|------------------|----------------------|--------------------------|----|----|----|----|----|----|----|----|----|----|----|----|----|----|----|----|----|----|----|----|
| | 3 | 5 | 7 | 9 | | | | | | | | | | | | | 11 | 13 | 15 | 17 | 19 | 21 | 23 | 25 | 27 | 29 | 31 | 33 | 35 | 37 | 39 | 41 | 43 | 45 | 47 | 49 | 51 |
| 202 | | | | | | | | | | | | | | | | | | | | | | | | | | | | | | | | | | | | | |
| 203 | | | | | | | | | | | | | | | | | | | | | | | | | | | | | | | | | | | | | |
| 204 | | | | | | | | | | | | | | | | | | | | | | | | | | | | | | | | | | | | | |
| 205 | | | | | | | | | | | | | | | | | | | | | | | | | | | | | | | | | | | | | |
| 206 | | | | | | | | | | | | | | | | | | | | | | | | | | | | | | | | | | | | | |
| 207 | | | | | | | | | | | | | | | | | | | | | | | | | | | | | | | | | | | | | |
| 208 | | | | | | | | | | | | | | | | | | | | | | | | | | | | | | | | | | | | | |
| 209 | | | | | | | | | | | | | | | | | | | | | | | | | | | | | | | | | | | | | |
| 210 | | | | | | | | | | | | | | | | | | | | | | | | | | | | | | | | | | | | | |
| 211 | | | | | | | | | | | | | | | | | | | | | | | | | | | | | | | | | | | | | |
| 212 | | | | | | | | | | | | | | | | | | | | | | | | | | | | | | | | | | | | | |
| 213 | | | | | | | | | | | | | | | | | | | | | | | | | | | | | | | | | | | | | |
| 214 | | | | | | | | | | | | | | | | | | | | | | | | | | | | | | | | | | | | | |
| 215 | | | | | | | | | | | | | | | | | | | | | | | | | | | | | | | | | | | | | |
| 216 | | | | | | | | | | | | | | | | | | | | | | | | | | | | | | | | | | | | | |
| 217 | | | | | | | | | | | | | | | | | | | | | | | | | | | | | | | | | | | | | |
| 218 | | | | | | | | | | | | | | | | | | | | | | | | | | | | | | | | | | | | | |
| 219 | | | | | | | | | | | | | | | | | | | | | | | | | | | | | | | | | | | | | |
| 220 | | | | | | | | | | | | | | | | | | | | | | | | | | | | | | | | | | | | | |
| 221 | | | | | | | | | | | | | | | | | | | | | | | | | | | | | | | | | | | | | |
| 222 | | | | | | | | | | | | | | | | | | | | | | | | | | | | | | | | | | | | | |
| 223 | | | | | | | | | | | | | | | | | | | | | | | | | | | | | | | | | | | | | |
| 224 | | | | | | | | | | | | | | | | | | | | | | | | | | | | | | | | | | | | | |
| 225 | | | | | | | | | | | | | | | | | | | | | | | | | | | | | | | | | | | | | |
| 226 | | | | | | | | | | | | | | | | | | | | | | | | | | | | | | | | | | | | | |

Appendix figure 1. The form used for fish biological analysis.

Заполнил

Проверен

**STANDARD SAMPLING PROCEDURE FOR BARENTS SEA CAPELIN. A DESCRIPTION OF
STANDARD SAMPLING TECHNIQUE AND METHODS APPLIED TO IMPROVE THE
REPRESENTATIVENESS OF THE SAMPLES.**

By

Harald Gjørseter
Institute of Marine Research,
P.O. Box 1870,
N-5011 Bergen, Nordnes
Norway

ABSTRACT

The various types of samples, the observations made on each fish, and the coding procedure for these observations are described. The standard procedure of otolith studies on the capelin stock is described in detail, including dissection out, rinsing, embedding, reading and measuring. A description of the present ageing method used at the IMR in Bergen is included.

In addition, a method for using the samples to construct representative absolute distributions is presented, based on weighing the samples relative to the acoustic abundance estimate. An appendix describes the format in which the coded information is stored for computer treatment.

1. INTRODUCTION

The capelin stock is sampled for the purpose of biological investigation. Different types of samples are taken, according to the purpose of the survey, and additional samples may be taken from commercial catches. The most frequent type of sample is the "standard biological capelin sample", and only this sample is considered in the present paper.

2. SAMPLING PROCEDURE

2.1 Sampling on scientific cruises

When a capelin catch is onboard the vessel, a random sample of 100 fish is taken, and the sample is processed immediately. On a sampling form, specially designed for later punching of the data, the following details on the fishing station are recorded:

position,
species,
vessel name,
station no.,
sampling gear,
year,
month,
date, and
depth.

For every fish in the sample the volume to nearest ml is measured by immersing the fish in water in a graduated cylinder, and the total length is measured to the nearest 1/2 cm below (from tip of snout to end of lower lobe of caudal fin). Fish above 10 cm are opened, and the sex, maturity stage, and the degree of stomach fullness are determined. Usually the sagittae are removed for all fishes in the sample, and used for ageing purposes. A description of the ageing technique is given in section 3.

The maturity scale used is one modified after Nikolsky (1963). (See Table 1). This maturity scale is based on macroscopic criteria only. In addition, a new maturity scale developed by Forberg (1983) has been used for females since 1980, (Forberg and Tjelmeland 1984). This scale is based on microscopic inspection of whole oocytes. This scale has ten stages, some of them with up to three subdivisions. It allows for a more precise staging of the females, especially during periods of fast maturation.

The stomach fullness is determined using a scale with six stages (Monstad 1971), of which

- 1 - empty stomach
- 2 - very little content
- 3 - some content
- 4 - stomach full, but not expanded
- 5 - stomach expanded (food visible from outside)
- 6 - stomach everted

TABLE 1 MATURITY SCALE

| Code | Stage | Description | Females | Males |
|------|----------------------|--|--|--|
| 1 | Juvenile(a) | Gonads threadlike, sexes can hardly be separated. | | |
| 2 | Juvenile(b) | Gonads increasing in volume. Sex can be determined. | Ovaries transparent, without colour. | Testes transparent, without colour. |
| 3 | Maturing(a) | Gonads opaque, blood vessels can be seen. | Ovaries with yellow/white grains. | Testes white or with white spots. |
| 4 | Maturing(b) | Gonads increasing in vol. Blood vessels distinct. | Ovaries pink or yellowish white filling up 2/3 or more of body cavity. | Testes light grey or white No milt-drops appear under pressure. |
| 5 | Maturing(c) | | Ovaries occupy whole of body cavity. Most eggs transparent | Testes grey. Milt run with some pressure. |
| 6 | Spawning | Runny gonads | | |
| 7 | Spent | Gonads emptied. Some residual eggs and sperm may occur | | |
| 8 | Spent/ recovering | Gonads small and collapsed | | |

2.2 Sampling from commercial catches

At the start of each fishing season a sampling program is initiated, which provides samples from the commercial catches. These samples are of two types, length samples and standard biological samples (Section 2.1). From each catch a length sample of about 100 fishes is taken. This is done routinely in both fishing seasons from all catches which are landed at meal and oil factories. In the winter season, two factories are selected, one in the eastern, the other in the western part of the fish landing area, at which a sample of 100 specimens is taken from about every fourth catch, frozen and sent to the Institute of Marine Research in Bergen. Not all these samples are actually processed, but emphasis is put on getting a good spatial coverage during the fishing season. In the summer season this procedure would not provide samples with adequate quality, so samples are then frozen onboard the scouting vessels operating in the fishing area. The catches meant for human consumption represents a special problem as these catches are mainly processed onboard the fishing vessels, and samples are therefore not accessible.

The frozen samples are processed according to the procedure described for the samples taken onboard scientific vessels, but the maturity determination according to the new microscopic criteria may be difficult and is often omitted on frozen material.

The length samples from each catch are the basis for the fishery statistics delivered on a monthly basis, together with the total volume of the catch and length-age and weight-age keys. These statistics are broken down to number or weight per age-group by weighing the length sample to give the total length distribution for the whole catch and then applying the appropriate key. The keys are constructed on the basis of the biological samples taken in the fishing area the catches originate from.

3. AGEING TECHNIQUE

The ageing of the fish sampled from the capelin stock is essential to the assessment model in use. Only by reliable ageing can a good estimate for the abundance of each age-group be achieved, which in turn is a prerequisite for reliable estimates of growth, mortality and maturity.

Otoliths have been preferred in age reading of capelin. This is partly because scales do not develop during the first year of life, and the otolith zones are also relatively well pronounced. Of the three otolith pairs only the saccular otoliths - the sagittae - are used for ageing purposes.

This section describes the standard technique of handling the otoliths, from when they are removed from the fish, to when they are embedded and prepared for reading. A description of the ageing is also included, together with a discussion of the ageing technique which has been and is now in use at the Institute of Marine Research in Bergen.

3.1 Dissection of the fish and preparation of otolith samples

As mentioned earlier, a standard sample of capelin usually contains 100 fish. With some few exceptions, otoliths are taken from the whole sample. In some cases only a part of the sample is aged, usually when there has been frequent sampling and/or uniform length distributions in an area. In these situations a random subsample of 20-40 specimens is aged.

The sagittae are removed from the underside of the cranium by a scalpel, after removal of the gills and sectioning of the labyrinth organ. This is usually quite easy, but operating under a dissecting microscope may be helpful when working with small 0-group fish and larvae. After rinsing in water, the otoliths are placed convex side up in cavities in specially designed otolith plates. The rinsing may be done either by rubbing the otoliths between the wet fingers or by placing them in waterfilled holes in plastic mouldings designed for this purpose. In this case, the otoliths are rinsed by means of a fine brush and then placed on the otolith plates. Each hole in these plates is labeled with a number corresponding to the fish's number in the sample. The otoliths are then left to dry. This dehydrating of the otoliths improves the readability, while too early embedding will cause the otoliths to turn opaque after storing. Sufficient drying time will depend upon air temperature, and the size of the otoliths.

The otoliths are embedded in the synthetic mounting medium Eukitt which makes them become partly transparent, the winter rings discernable. The otolith plates, each with ten pairs of otoliths, are labelled for easy reference (Fig 1).

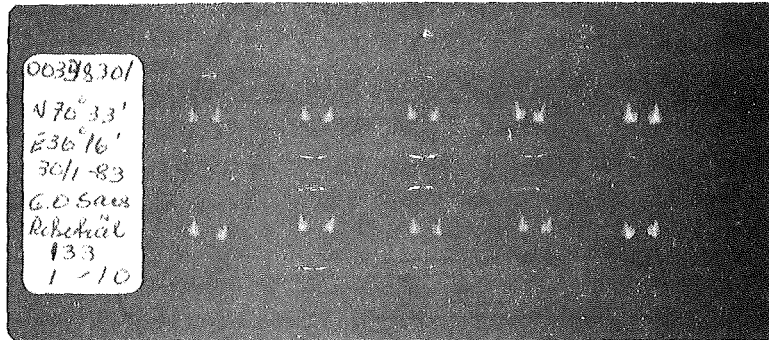


Figure 1. Otolith plate with embedded capelin otoliths.

Reading of the otoliths is done under a dissecting microscope, using about 40 X magnification and reflected light. The otolith plates are black, and so the winter rings appears dark because they are transparent. The zones of summer growth however, are opaque due to the high calcium to protein ratio, and thus appear white under the microscope. A scale mounted in one of the oculars is used for measuring the growth zones.

3.2 The reading and measuring of growth zones

The following description is an excerpt from sampling instructions used at the Institute of Marine Research (Anon 1984).

The age is given as the number of winter rings. However, all fishes shall by convention shift their age on January 1, so the age of a fish is not its exact lifespan, but the number of winters it has experienced during its lifetime. This implies some modification of the rule cited above. If an otolith with a hyaline margin is found in late autumn, i.e. its winter ring has started to form, this outer winter ring should not be counted. Also, if an otolith is found in spring without a winter ring in the margin, the margin shall be counted as a winter ring.

The measurements of the growth zones are undertaken not only for the purpose of growth studies, but also to assess the validity of the ageing. The measuring is done according to fig. 1 along a line perpendicular to the longest radius through rostrum. The radius in each winterring is measured from the center of the otolith to the inner margin of the winterring. As the inner margin of the first winter ring is often indistinct, this ring is measured to its outer margin. In addition, the total radius to the otolith edge is measured. The measurements are in eye-piece units which at the magnification most often in use, (40X), corresponds to 0.025 mm. As other microscopes with slightly different magnifications are sometimes used, the measurements are calibrated against a ruler for each sample taken, and the calibration factor is written on the sampling form.

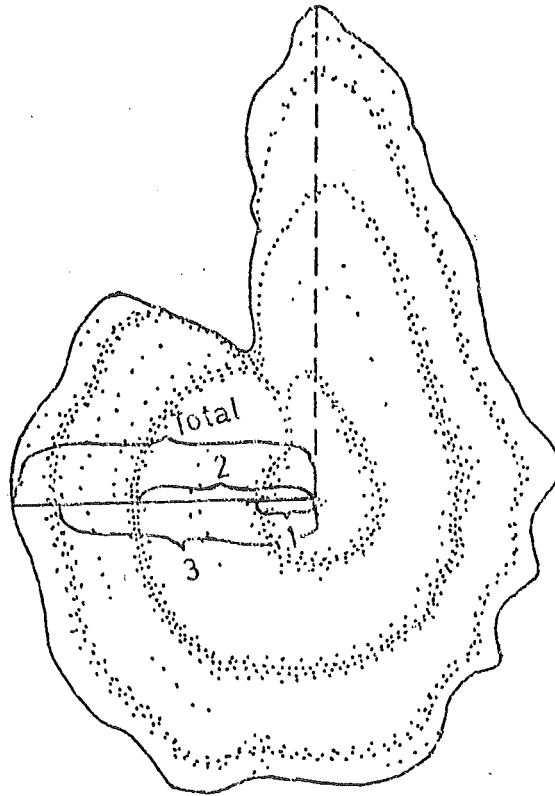


Figure 2. Capelin otolith showing the measurement taken. 1, 2 and 3 are radii in first, second and third winter rings respectively. Total means total otolith radius.

As not all the otoliths are equally easily read and measured, a code for readability is set. Its use is explained below.

3.3 Readability scale

An otolith in which the winter rings appear clearly is given readability 0. This implies that the age is set equal to the number of winter rings, and the radii in these rings are measured. In case of false rings, this readability shall be used if these rings can easily be discriminated from the winter rings.

Two kinds of otoliths are given readability 1. Otoliths in which the age can be given with a high rate of accuracy, but where the winter rings are impossible to measure in the desired direction belong in this group. (See fig. 1). This could be caused by split rings, broken otoliths etc. The age is set as the number of winter rings, but no measurements are made.

Secondly, readability 1 is used when the number of winter rings clearly seen is thought not to represent the true age of the fish, because the first ring seen is unexpectedly large, and the central part of the otolith is so thick that the true first ring may have disappeared. In such cases, usually involving older fish, the age is set one year older than the number of winter rings seen, and the radii in these rings are measured, but the first ring seen is measured as the second ring and so forth.

Readability 2 is given in cases where an age cannot be given with any confidence. The reason may be false rings which cannot be discriminated from winter rings, broken otoliths, opaque or crystalline otoliths etc. Often a "minimum age" can be given, and in such cases this age is given as the minimum number of rings which one believes represents winter growth. This is done to show the ratio of older fish among those which cannot be aged. The fish with readability 2 are not used when constructing age-distributions. No measurements of radii are made on otoliths with readability 2. This readability is also used when both otoliths are missing.

3.4 Discussion of the ageing method

As the life cycle of capelin is relatively short, and the winter rings are usually distinct, the age reading of capelin is probably quite reliable. However, problems do occur, which may be divided into two categories; (1) the thickening of the otolith which causes the first ring to disappear in older otoliths, and (2) false rings which may be present quite frequently, and most pronounced in otoliths more than three years old.

The ageing method described here aims to reduce the number of wrongly aged otoliths, and is developed in light of these different problems. Various ways of reading and interpreting capelin otoliths are described in the literature (see Bailey *et al.*, 1977; Hamre, 1977; Prochorov, 1968; Tempelmann, 1968).

Judging from these papers, and from experience gained during routine ageing, the first translucent zone in the otolith is the main problem in ascertaining age. The question is whether a translucent ring or area in the center of the otolith should be counted as a first winter ring, regardless of its size. Different methods have been considered for solving this problem, but as yet there seems to be no conclusive support for any method covering all the north Atlantic capelin stocks. Growth considerations were used to assess the validity of ageing by Bailey *et al.* (1977) in Canadian waters and by Hamre (1977) for the Barents Sea. By backcalculating lengths at deposition of the first ring and comparing them with lengths from sampling, Bailey reached the conclusion that the first ring was a true winter ring, but a second ring was found to be deposited during the process of metamorphosis, which normally occurred during its second year of life. This "metamorphic check" was found in 77% of the one and two years old fish and 44% of adults, this decrease being interpreted as an obfuscation of the check by the increasing opacity observed in older otoliths. The absence of the metamorphic check in some otoliths could result from its deposition simultaneously with the first or second annulus.

Hamre (1977), working with Barents Sea capelin, studied this problem during the summer of 1976. Both 0- and 1-group capelin were sampled and length at deposition of first ring was backcalculated. He found that even the smallest fish with one ring, with a modal length of 5.8 cm in early July and a mean length at deposition of the first ring of 4.2 cm, were far too big to be the offspring of that year's spawning. It was found that even at the border of the larval drift towards the north and east the mean length of the larvae was less than two cm. He concluded that the first ring, even with a radius as small as 0.05 mm, reflects the first year growth and should be counted as the first winter ring. Hamre located a group of one year old fish with small first rings in the southeastern Barents Sea in 1976, comprising about

10% of the 1975 yearclass. It seems reasonable to believe that this group was the offspring from late spawners, and thus the phenomenon of small first rings is probably linked to the magnitude of late spawning.

It is difficult to compare the ageing methods used on the capelin stocks on either side of the North Atlantic. Differences in growth rate, spawning time and duration of spawning activity make any direct comparison of otoliths uncertain.

At present, the ageing method discussed above for the Barents Sea capelin is used at the IMR in Bergen. This method, to count each translucent zone as a winter ring, was also supported by Prochorov (1968). Individual fishes have been detected which seem to contradict these findings, e.g. fishes of six to seven cm length with two clear translucent rings caught in the autumn, and also samples within 1-groups of very uniform length-distribution where some individuals have an extra ring inside and are thus aged two years.

The consequences of false ageing are difficult to assess, but are of course linked to how many fishes are involved relative to the total number of aged fishes. The primary effect of giving a fish a false age is to transfer the fish to an age-group above (if a false ring is counted) or below (if a ring is overlooked). This will in turn affect the analysis of the stock/recruitment relationship. In addition to the effects on stock assessment, false ageing will introduce noise and/or bias to growth studies.

Observations indicate that some individuals probably get a false age, but as this probably is a rare event, the practical consequences are small. However, it must be concluded that the problem of ageing is not yet completely solved for the Barents Sea capelin stock, and further validation of the method in use is needed.

Appendix 1 gives some details on punching and storage of the data.

4. METHODS APPLIED TO IMPROVE THE REPRESENTATIVENESS OF THE DATA

The data listed here can be processed further by a computer, resulting in different kinds of distributions, of which the most commonly used are age, length, weight, sex, maturity and otolith growth zone width. These distributions may be computed on the basis of yearclass, age, year, season, or area, or whichever combination is desirable.

However, when we want to compare these distributions for different yearclasses, we encounter statistical problems, how representative are the samples taken in different areas for the total stock or a yearclass? To be specific; is it statistically correct to pool all the samples and let them represent the total stock? It would be correct if the relative number of fishes in the samples matched the relative number of fishes in the subpopulation inhabiting the subarea for which the sample is considered representative; or if there was no geographical variation in the biological parameters. The last assumption does not hold for capelin, and the first is also unreasonable, at least when the samples are taken on a research survey. This because the samples will be more or less evenly distributed over the whole distribution area, even when the major part of the stock is residing in a small portion of this area. Pooling the samples would then give too much weight to the fishes in the less dense populated areas.

This problem can however be circumvented by weighing the samples according to the abundance of fish in the subareas. We are now using a procedure which makes use of the acoustic estimate of the number of fish as a weight for the samples. As yet the technique is only used for data sampled on the joint Soviet/Norwegian cruise in September, because this is the only cruise in which the whole stock is sampled and assessed acoustically. The method and the assumptions on which it is based are briefly outlined below.

The Barents Sea is divided into statistical subareas called locations, (Fig. 3), which are the basic divisions used for the abundance estimation. The 0-group capelin is not covered by the integrating system, and is thus not included in the abundance estimate. The number of fish one year old and older in each length-group in one location is then:

$$N(l) = \frac{p(l)}{\int \frac{p(l)}{C(l)}} M A \quad (1)$$

where $p(l)$ = the length distribution of fish in the location.

$C(l)$ = a constant depending on the instruments used, the fish species and length.

M = mean integrator output for the location.

A = area of location.

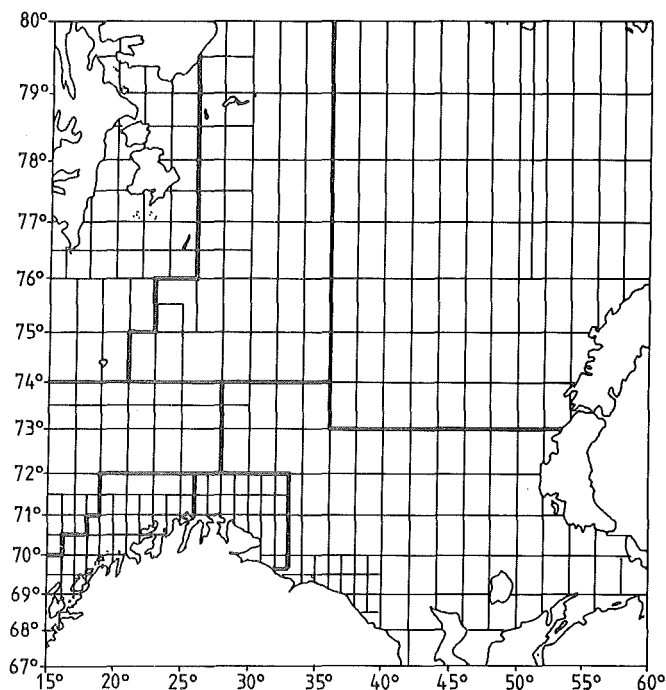


Figure 3. Map showing the Barents Sea with the statistical squares mentioned in the text.

The length-dependent part of the C-value is for capelin found to be $l^{-1.91}$. This gives:

$$N(l) = \frac{p(l)}{\int p(l) l^{1.91}} M A C \quad (2)$$

where C is the length-independent part of the C-value.

In some cases we want to extract a part of the stock (e.g. age two and older) from the stock of age one and older. The absolute length distribution of a subgroup of fish N_i is given by:

$$N_i(l) = \frac{p_i(l)}{\int p(l) l^{1.91}} M A C \quad (3)$$

where $p_i(l)$ is the length distribution of subgroup no. i and $p(l)$ is the total length distribution.

We use one or more samples to construct the length distribution $p(l)$. We call the length distribution in each sample $q_j(l)$, and give each sample a weight V_j . To make the contribution from each sample to $p(l)$ independent of the sample size, we normalize the length distribution in each sample by dividing by the total number of fish in the sample, q_j . This gives:

$$p(l) = \sum_j V_j \frac{q_j(l)}{q_j} \quad (4)$$

We may think of the fish in the location as comprized of as many subpopulations as there are samples. If we let one sample be representative for one subpopulation, the absolute length distribution of the subgroup i in subpopulation j is:

$$N_{ij}(l) = \frac{\sum_j V_j \frac{q_{ij}(l)}{q_j}}{\sum_j \left(\sum_j V_j \frac{q_j(l)}{q_j} \right) l^{1.91}} M A C \quad (5)$$

or

$$N_{ij}(1) = \sum_j \frac{M A C \frac{V_j}{q_j}}{\sum_j \left(\frac{V_j}{q_j} q_j(1) 1^{1.91} \right)} q_{ij}(1) \quad (6)$$

The appropriate weight for each sample in the location is then:

$$\text{Weight} = \frac{M A C \frac{V_j}{q_j}}{\sum_j \frac{V_j}{q_j} q_j(1) 1^{1.91}} = \frac{M A C \frac{V_j}{q_j}}{\sum_j \frac{V_j}{q_j} \sum_j q_j(1) 1^{1.91}} \quad (7)$$

This can be thought of as the sample's (or the subpopulation it represents) contribution to the integrator value in the location. If the sample is used also in other locations, the sample's weight in each of the locations have to be added to get the total weight for each sample.

When the weighed samples are used to construct distributions, the parameter value belonging to each fish is counted as many times as the weight for that sample states. If, for example, we construct the length distribution of fishes two years old and older for a subarea, the parameter value for each fish in a sample with weight 10 would count twice as much as that for a fish in a sample with weight 5.

Weighing the samples has two effects. The distributions will be representative for the population inhabiting the area, and the number of fish is the actual number estimated by the acoustical method.

The weighing procedure presented here rests on the following assumptions:

1) The age and length distributions of the fishes one year old and older in a sample is the same as that in the location which the sample is used to represent.

2) The quantity N in equation (1) is the number of fishes one year old and older in the location.

Computer programs have been made, which, by input of M for the different locations, their area, the samples used and their weight of representativeness in each location, will, after going through the files of biological data, produce a list of the numbers of all the samples used and their appropriate weight based on the chosen subgroup. By input of this list to the programs computing the distributions of the different biological parameters, these distributions will be weighed accordingly.

5. REFERENCES

- Anon 1984 Prøvetakingsinstruks. Pelagisk fisk Nord/Sør. Fiskeridirektoratets Havforskningsinstitutt. [mimeo.] (In Norwegian)
- Bailey, R.F.J., K.W. Able and W.C. Leggett 1977. Evidence for the presence of a metamorphic check in capelin (Mallotus villosus) otoliths and implications for age determination. J. Fish. Res. Board Can. 34:2008-2014
- Dalen, J., A. Raknes, and I. Røttingen, 1976. Target strength measurements and acoustic biomass estimation of capelin and 0-group fish. Coun. Meet. int. Coun. Explor. Sea, 1976 (B:37):1-13 [Mimeo.]
- Forberg, K. 1983. Maturity classification and growth of capelin, Mallotus villosus (M), oocytes. J. Fish. Biol. 22:485-496.
- Hamre, J. 1977. On the interpretation of the central zone in otoliths of capelin from the Barents Sea. Int. Coun. Explor. Sea C.M. 1977 /H:37 23pp [mimeo.]
- Monstad, T. 1971. Alder, vekst og utbredelse av lodde (Mallotus villosus) i Barentshavet og ved kysten av Nordnorge 1968-1970 (Age, growth and distribution of capelin in the Barents Sea and at the Norwegian coast 1968 - 1970). Unpublished cand. real. thesis Univ. of Bergen, Norway. [mimeo.] (In Norwegian)
- Nikolsky, G.V. 1963. The ecology of fishes. Academic Press, London. 352 pp.
- Prokhorov, V.S. 1968 Materials on the ecology of capelin in the Barents Sea. Rapp. P.-v. Reun. Cons. Perm. Int. Explor. Mer, 158:23-31
- Tempelmann, W. 1968 Review of some aspects of capelin biology in the Canadian area of the Northwest Atlantic. Rapp. P.-v. Reun. Cons. Perm. Int. Explor. Mer, 158:41-53

APPENDIX 1

The sampling form is shown in Figure 1. The same form is used also for other pelagic species, so all the columns are not exclusively for capelin.

In the upper right-hand corner of the form, some details are given which are not stored in the computer. This is species, location no., vessel name, fishing station no., gear, preservation technique, and name of person responsible for taking the sample, reading and measuring the otoliths. However, some of these data are given in coded form on the A-record .(See below).

The data stored on magnetic storing media are organized in two types of records, an A-record for each sample and a B-record for each fish in the sample. The following tables show the format of these records.

Format of A-record.

| Position | Content |
|----------|--|
| 1 | A |
| 2-4 | Species code (B02 for capelin) |
| 5-8 | Sample no. |
| 9-10 | Year (last two digits) |
| 11-12 | Month |
| 13-14 | Day |
| 15-16 | Gear code |
| 17-19 | Depth |
| 20 | Position code |
| 21-24 | Latitude |
| 25-28 | Longitude |
| 29 | Preservation code |
| 30-33 | Weight of catch |
| 34 | Ageing code (2 denotes otoliths taken) |

The sample no. (5-8) consists of a serial no. and a specific sample no. The serial no. bears information on vessel and type of sample (random sample or other special types of samples). The sample no. starts from 01 each month, and so the complete sample no. consists of all the positions 5-12. Consequently, the first random sample taken onboard the G.O. Sars in september 1984 will get the no. 00018409. The depth (17-19) is the fishing depth.

Format of B-record.

| Position | Content |
|----------|--|
| 1 | B |
| 2-12 | Copy of pos. 2-12 of record a |
| 13-15 | The fish's number in the sample |
| 16 | Weight or volume code (1=volume, 2=weight) |
| 17-19 | Weight or volume of fish in g or ml |
| 20 | Not used for capelin |
| 21-23 | Length in mm |
| 24 | Not used for capelin |
| 25 | Sex: 0=not determined, 1=female, 2=male |
| 26 | Maturity according to the old maturity scale |
| 27 | Stomach filling degree |
| 28 | Not used for capelin |
| 29-30 | Maturity of females according to the new scale |
| 31-32 | Age |
| 33 | Readability code |
| 34-36 | Not used for capelin |
| 37-38 | Ocular micrometer calibration (no. of EPU in 2 mm) |
| 39-50 | Radia in up to 6 winter rings in EPU |
| 51-52 | Total radius in EPU |
| 53-54 | Not used for capelin |

After punching, some test programs are run on the data, to search for obvious errors obtained during coding or punching of the data. The data are then stored in files, each file containing all capelin data sampled during one year. During the autumn cruise, the data are punched onboard the G.O.Sars, so the data are available for computer treatment upon termination of the cruise.

| KORT | ART | PRØVE NR. | | | | | | DAG | REDSKAP | DYP | N.SØ.V. | BREDD (OMR. LOK.) | | | | LENGDE | | | | KONS. | FANGST MENGDE | | | | OT./SKJ. | OMR. LOK. / POSISJON | | | | | | | | | | | | | | |
|------|-----------|-----------|----|------|----|----|--------|-----|---------|------|---------|-------------------|--------|--------|---------|--------|--------|------|------|--------|---------------|-----------------|----|----|----------|----------------------|----|-------|--------|----|----|----|-----|-----------------------|----|-------|---------------|----------|-----|------|
| | | NR. | ÅR | MND. | 13 | 14 | 15 | | | | | 16 | 17 | 18 | 19 | 20 | 21 | 22 | 23 | | 24 | 25 | 26 | 27 | | 28 | 29 | 30 | 31 | 32 | 33 | 34 | ART | SKIP | | | | | | |
| A | | 1 | 2 | 3 | 4 | 5 | 6 | 7 | 8 | 9 | 10 | 11 | 12 | 13 | 14 | 15 | 16 | 17 | 18 | 19 | 20 | 21 | 22 | 23 | 24 | 25 | 26 | 27 | 28 | 29 | 30 | 31 | 32 | 33 | 34 | KONS. | FANGST MENGDE | OT./SKJ. | ART | SKIP |
| | | | | | | | | | | | | | | | | | | | | | | | | | | | | | | | | | | TILF. PRØVE / UTPLUKK | | | | | | |
| KORT | FISKE NR. | VOL./VE | | VEKT | | | LENGDE | | | FETT | KJØNN | STADIUM | MAGEF. | FORDR. | VIRYLER | ALDER | LESBH. | TYPE | RAND | KJERNE | KALIBR. | VEKSTSONER MÅLT | | | | | | LEVER | PARAS. | | | | | | | | | | | |
| | | 16 | 17 | 18 | 19 | 20 | 21 | 22 | 23 | | | | | | | | | | | | | 24 | 25 | 26 | 27 | 28 | 29 | | | 30 | 31 | 32 | 33 | 34 | 35 | 36 | 37 | 38 | 39 | 40 |

INDIVIDSKJEMA FOR PELAGISK FISK - KORTTYPE A & B

Appendix Figure 1. The data form used for standard samples of capelin.

**SOME PECULIARITIES OF CAPELIN MIGRATIONS DEPENDING ON THERMAL
CONDITIONS IN THE BARENTS SEA**

by

V.K. Ozhigin and G.I. Luka

Polar Research Institute of Marine Fisheries and Oceanography (PINRO),
6 Knipovich Street,
183763, Murmansk,
USSR

ABSTRACT

The influence of temperature variations in the Barents Sea on the distribution and pattern of capelin migrations at different stages of their yearly cycle is analysed. Large scale changes of water temperature are shown to generate a significant displacement of the distribution area of capelin, and, consequently, change their pattern of migration.

In warm years the feeding area is more extensive than in cold ones, reaching as far as Franz Josef Land and the northern coast of the Novaya Zemlya where they may form commercial concentrations.

In warm years, the over-wintering grounds of capelin can be found in some areas of the Polar front along western and eastern boundaries of the North Cape and Novaya Zemlya Currents. In cold years, capelin do not enter the eastern part of the wintering area.

The direction of spawning migrations and the time of approach to spawning grounds depend greatly on the location of feeding and wintering areas. Alongside with this, the pattern of coastal spawning migrations is also affected by the peculiarities of the temperature regime in the southern sea areas. The correlation coefficient for the centre of spawning and water temperature in the southwestern sea in October-December is 0.76.

Mass spawning of capelin is finished by the start of seasonal rise of water temperature on spawning grounds.

1. INTRODUCTION

The first chart of capelin migrations, drawn by Yu.V. Martinsen, (1933), covered the time of spawning migrations from the central areas to the southern Barents Sea. Later V.S. Prokhorov, (1965) improved the chart to include the feeding period, but feeding migrations were analysed only for central and northwestern sea areas. A more precise scheme of seasonal migrations taking into account feeding of capelin in the north-eastern sea and their wintering season, was composed by G.I. Luka and V.P. Ponomarenko (1983). Proceeding from the analysis of the latest data on spatial distribution of capelin, the features of their migrations at all stages of the yearly cycle are specified.

The paper analyses variations in the pattern of capelin seasonal migrations brought about by significant fluctuations of the thermal state of the sea.

2. MATERIAL AND METHODS

The thermal conditions in the Barents Sea were analysed by the data on water temperature in the 0-200 m layer from sections along the Kola Meridian, North Cape - Bear Island and along $74^{\circ}30'N$ east of the Bear Island collected by the PINRO laboratory of Fishery Oceanology in 1970 to 1983.

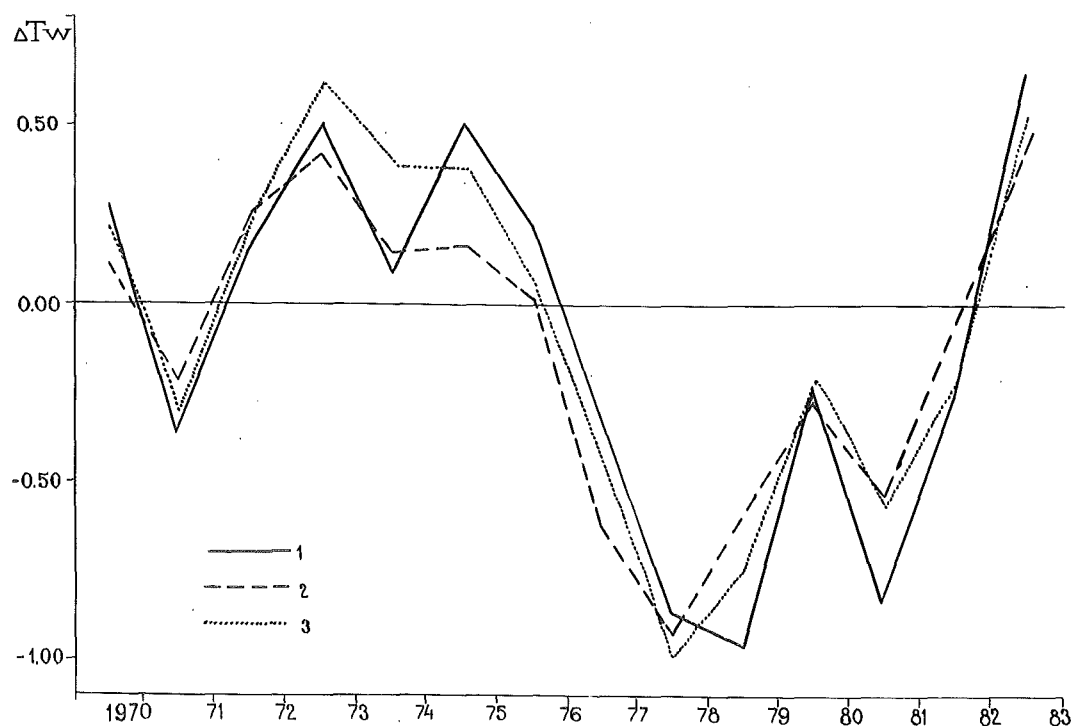


Fig. 1. Deviations of water temperature in the 0-200 m layer from the long term mean on sections from the Kola Meridian (1), North Cape - Bear Island (2) and along $74^{\circ}30'N$ east of the Bear Island (3).

When water temperature was 0.3°C above or below the long term mean were taken for warm or cold periods respectively. Thus, the years 1973-1975 are classified as warm, while 1978-1981 as cold years (Fig. 1). The years when deviation of water temperature from the long term mean do not exceed 0.3°C are taken for transitional years, e.g. the years 1970-1972, 1976-1977 and 1982.

The variations of temperature in the 0-200 m layer at the first station of the Kola Meridian were used as an index of the thermal state of the sea on spawning grounds at the Murman coast.

The area of maximum horizontal temperature gradients ($0.07-0.12^{\circ}\text{C}/\text{mile}$) at 50 m was identified as the position of the Polar front. This depth was chosen for analysis because of the negligible effect of summer radiational heating and because horizontal gradients of water temperature are more prominent than in other depths in all seasons.

Capelin migrations were analysed using data on fish distribution during different seasons as collected by the PINRO laboratory of pelagic fishes and taken from the papers of foreign scientists. The migration of post-spawning capelin from the Murman and Finnmark coasts in May and their distribution in June were studied from the data collected by the USSR research ships and from material published by Norwegian scientists (Haug and Monstad 1974; Buzeta et al., 1976; Dommasnes, 1978 etc.).

Annual acoustic surveys for stock assessment carried out by scientists from the Institute of Marine Research in Bergen and from PINRO served as a basis for analysis of capelin feeding migrations to northern and northeastern Barents Sea.

Wintering migrations and overwintering areas are studied on the basis of investigations undertaken by USSR research ships.

The data on spawning migrations of capelin to the Murman and Finnmark coasts during 1972 to 1983 are illustrated by Fig. 2 where spawning areas are also shown. The data on spawning grounds off the northern Norway are taken from the papers of Norwegian scientists (Gjøsæter and Sætre, 1973; Hamre and Sætre, 1976; Dommasnes et al., 1979 etc.).

3. RESULTS AND DISCUSSION

3.1 Overview

The main spawning of capelin is accomplished by early May. Spent survivors leave the Murman and Finnmark coasts and mix with the overwintered immature part of the stock. Soon after, active development of zooplankton (biological spring) starts in the southwestern Barents Sea. Lean from wintering and spawning, capelin begin to feed intensively. As waters warm up, reproducing and developing zooplankton move northward and north-eastwards, while capelin concentrations follow. However, the onset of biological spring and the rates of its northerly progress depend of the thermal state of the sea. In warm years zooplankton spawning begins earlier than in cold ones and is more intensive (Degtereva, 1979).

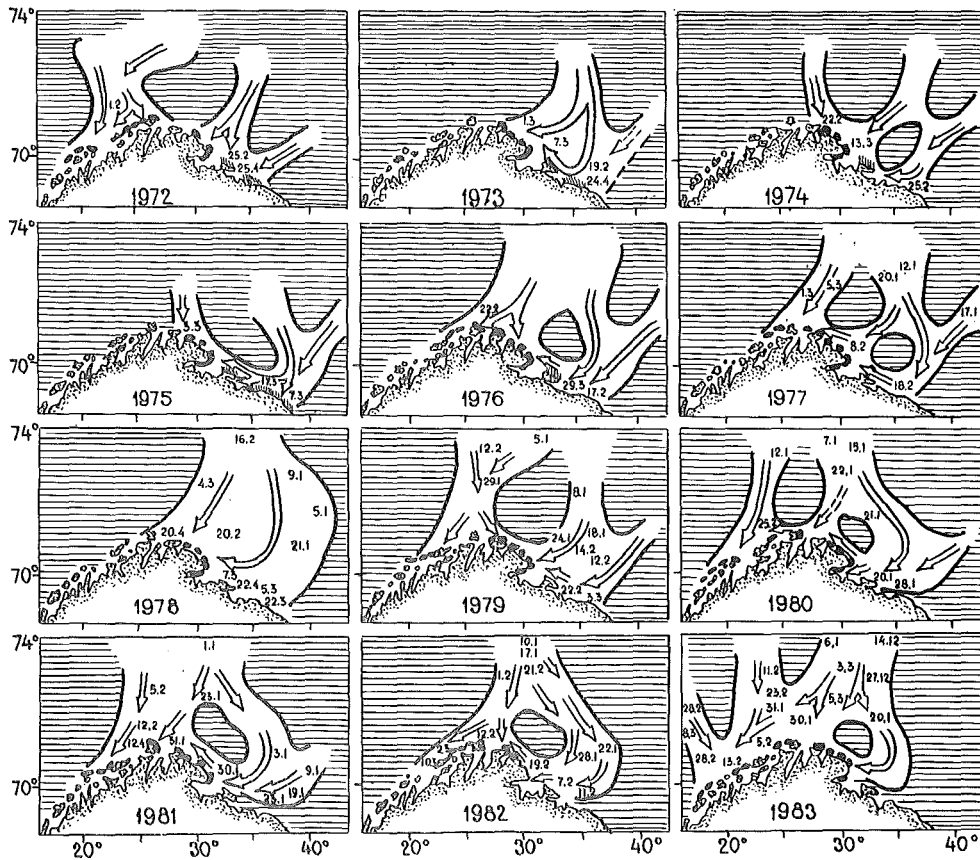


Fig. 2. Spawning migration of capelin to Murman and Finnmark coasts in 1972-1983. Figures show the date fish were found in the area. Blackened places stand for spawning grounds of capelin from Norwegian data. Spawning grounds at the Murman coast from PINRO data are shaded by vertical lines.

Having spawned at the Murman and Finnmark coasts, capelin migrate to feed in two directions - northwards and north-eastwards in the flows of the North Cape and Novaya Zemlya Currents, reaching the Western Deep at 76°N by late June. In cold years, owing especially to notable weakening of Atlantic currents and in particular the Novaya Zemlya Current, post-spawning capelin migrate from the Finnmark coast northwards to feed. Because of the concurrent late onset of biological spring, by the end of June capelin reach only 75°N (Fig. 3).

In July-August, parallel with the seasonal rise of water temperature in the sea, the fish advance northwards and north-eastwards following the increasing zooplankton population. By late August, the older age groups pass to the "cold" side of the front and occupy northern extremities of the range, while young fish remain farther southwards.

In September capelin reach the northern border of their feeding area. When the autumn cooling of water masses starts, the feeding migration of capelin finish. By this time zooplankton are at IV-V maturity stages and descend to the bottom. Consequently feeding activity of capelin diminishes.

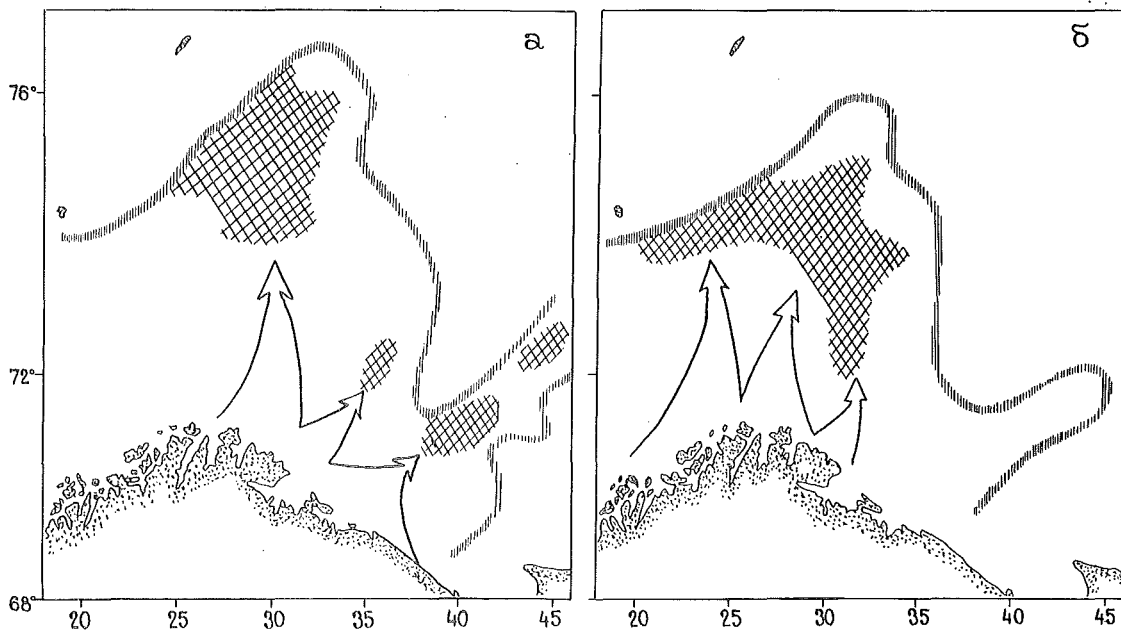


Fig. 3. Post-spawning capelin migrations in May from Murman and Finnmark coasts in warm (a) and cold (b) years. Main fish concentrations in June are shown by intersected shading, the zone of greatest temperature gradients at 50 m at this time is shown by vertical shading.

3.2 Feeding

In warm years, owing to favourable conditions and an earlier onset of biological spring, processes of zooplankton generation and maturation go on faster and by September advance farther to the north and northeast of the sea than in cold years. Capelin reach the limit of their distribution area off the Franz Josef Land and north of the Novaya Zemlya, feeding in the area stretching from the Hopen Island in the west to the Zhelaniya Cape in the east and from $72^{\circ}30'N$ in the south to $79^{\circ}30'N$ in the north (Fig. 4). It should be mentioned that commercial concentrations are formed mainly in the extreme east and west of the feeding area whereas in the center the capelin are very dispersed and rarely form stable concentrations.

In cold years the feeding area grows narrower and displaces to the north-east. As already mentioned by Norwegian scientists (Loeng 1981; Loeng et al. 1983), this results mainly from the decreasing water temperature and subsequently a later onset and slow northward advancement of biological spring. In these years capelin feed in the areas adjacent to the Polar front zone, forming dense and stable commercial concentrations on the eastern slope of Bear Island Bank, off Hopen Island, in the south of the Perseus Elevation and in the South Deep along the frontal zone.

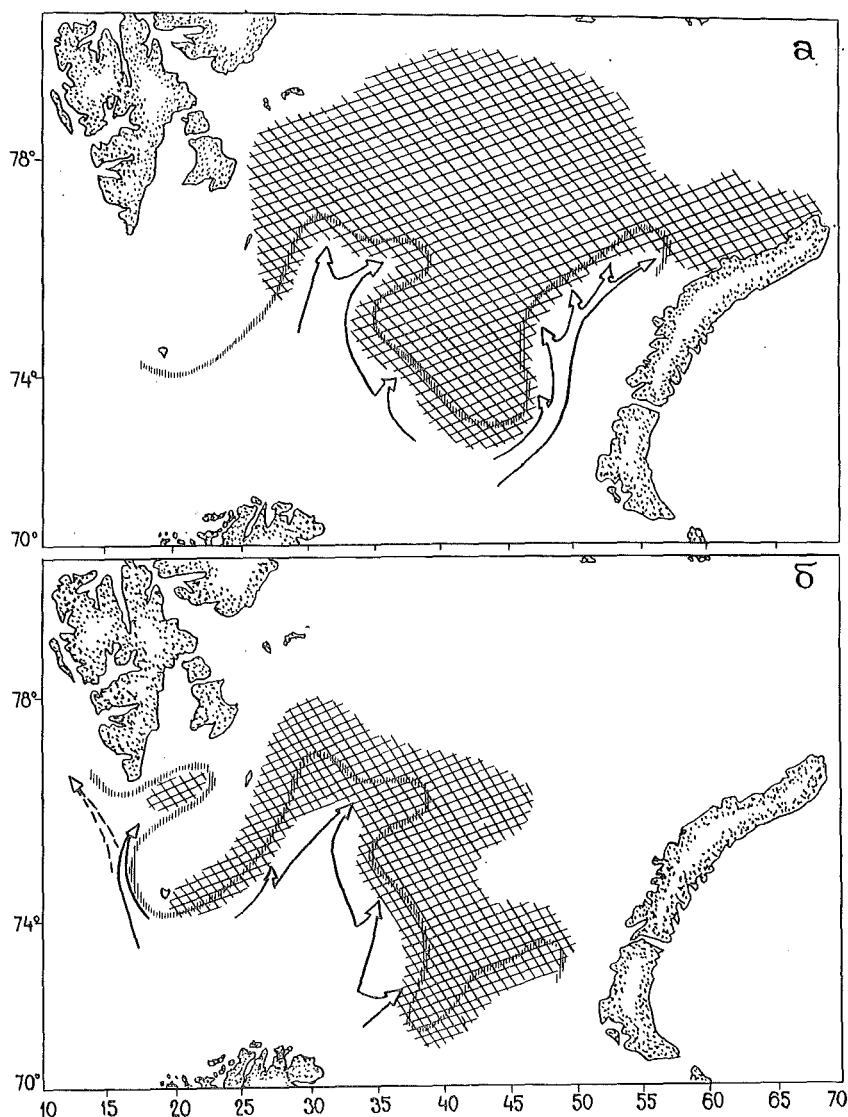


Fig. 4. Feeding migrations of capelin in July-August and their feeding areas in September (intersected shading) in warm (a) and cold (b) years. The zone of the greatest gradients of water temperature at 50 m in September is shown by vertical shading.

In the western Barents Sea year-to-year fluctuations of the Polar front position are low. Johannessen and Foster (1978) showed that the Polar front off the Bear Island is quasi-stationary, its position closely connected with the peculiarities of bottom relief. This is, probably, typical of more eastern parts of the front even as far as the Central Deep (Fig. 5). Conversely, in the eastern Barents Sea the position of the Polar front changes notably, depending on the thermal state of water masses. In warm years, as a result of the intensification of the Novaya Zemlya Current, the frontal zone in the eastern sea is observed northwards up to 76° - 77° N whereas in cold years it extends only to 73° - 74° N. These factors account for the great differences in the distribution of feeding capelin in the eastern sea in warm and cold years.

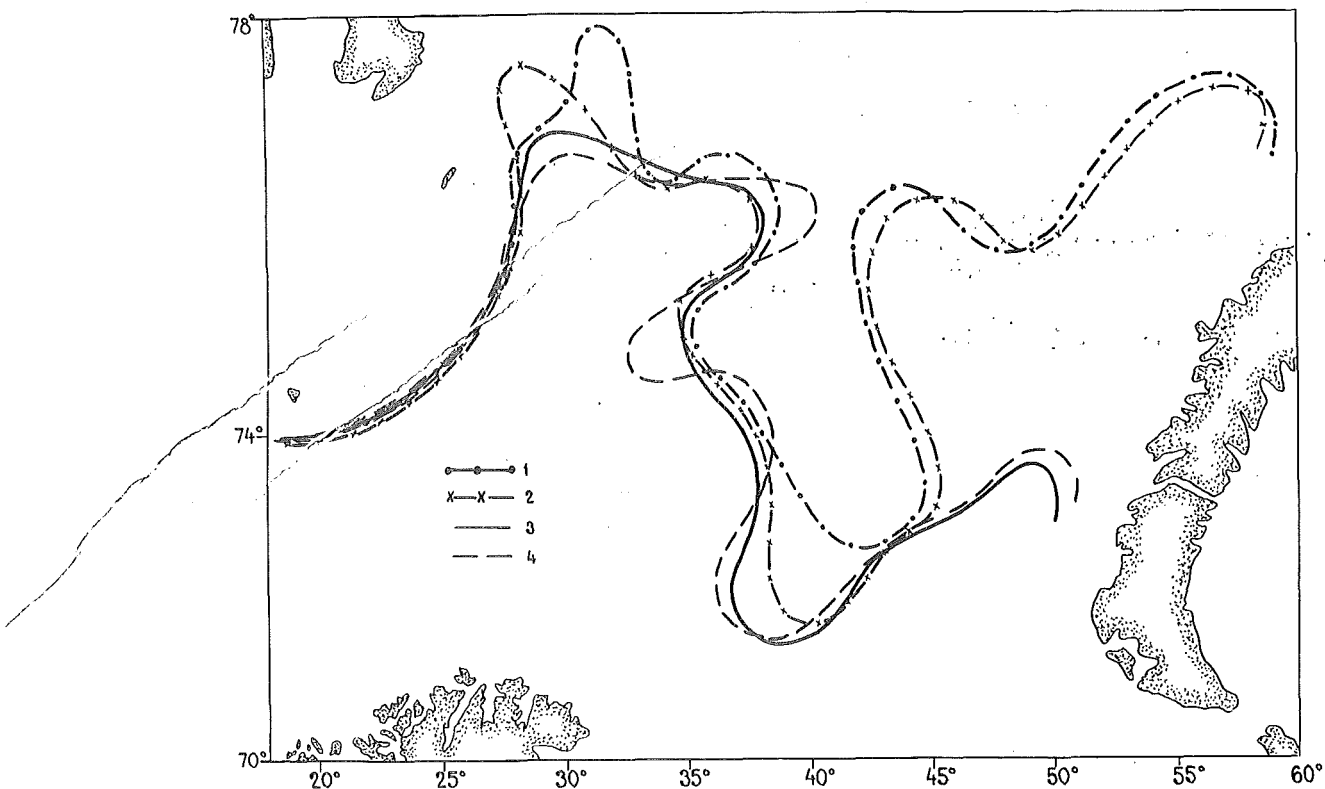


Fig. 5. The zone of greatest temperature gradients at 50 m in September in warm 1973-(1), 1975-(2) and cold 1979-(3), 1981-(4) years.

Both in warm and in cold years the southern border of the feeding area of capelin is located south of the frontal zone and avoids areas where temperature becomes unfavourable for fish.

3.3 Overwintering

In October mass migration of capelin to wintering areas takes place (Fig. 6). This migration begins earlier in the east than in the west, perhaps due to the warming effect produced by Atlantic waters restraining autumn cooling is more prominent in the west. From feeding areas, fish move southwards and south-westwards, passing to the "warm" side of the front in early November and descend to near-bottom depths to winter when convective mixing penetrates into deep layers.

The location of capelin over-wintering areas is determined greatly by conditions of their feeding. In warm years wintering migration proceeds in two main flows: from the northeast to the southwest and accumulating in the areas where the Novaya Zemlya Current borders on the cold waters of the Central Deep; from the western areas to the south along the outer limits of the Northern and Central Branches of the North Cape Current (Fig. 6). In cold years capelin migrate a much shorter distance to their overwintering grounds, lying adjacent to the frontal zone and occupying the bottom on the eastern slopes of Bear Island Bank, the northern part of the Western Deep and on the western slopes of the Central Elevation and Central Deep.

In November-December mature capelin winter in near-bottom layers along the frontal zone between the North Cape and Novaya Zemlya Currents where water temperature range from 2° - 4° C. In this period, the fish do not perform significant horizontal migrations, and are not very active.

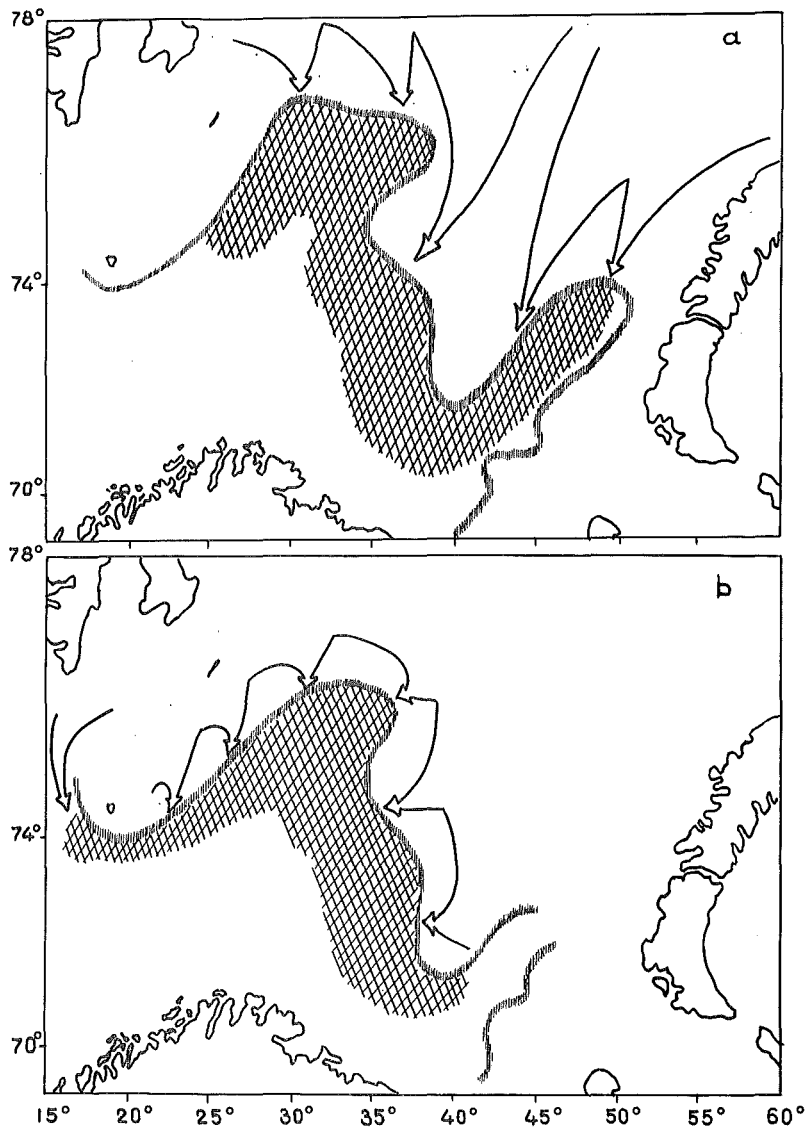


Fig. 6. Wintering migrations of capelin in October and their overwintering areas in November-December (intersected shading) in warm (a) and cold (b) years. The zone of greatest temperature gradients at 50 m in November-December is shown by vertical shading.

3.4 Spawning

In January maturing fish ascend to the surface layers and start their spawning migrations to the Murman and Finnmark coasts (Fig. 7). In warm years mature capelin accumulate in the extreme west and south of the Central Deep and migrate to the coast in two main directions: from the south of the Central Deep and adjacent areas towards the Western Coastal area, Kildin and Rybachya Banks; or from the west of the

Central Deep, the Central Plateau and east of the Demidov Bank to the eastern coast of Finnmark. In warm years spawning grounds are displaced to the east and mass spawning of capelin can be observed both along the Finnmark and Murman coast from 25° to 37° E.

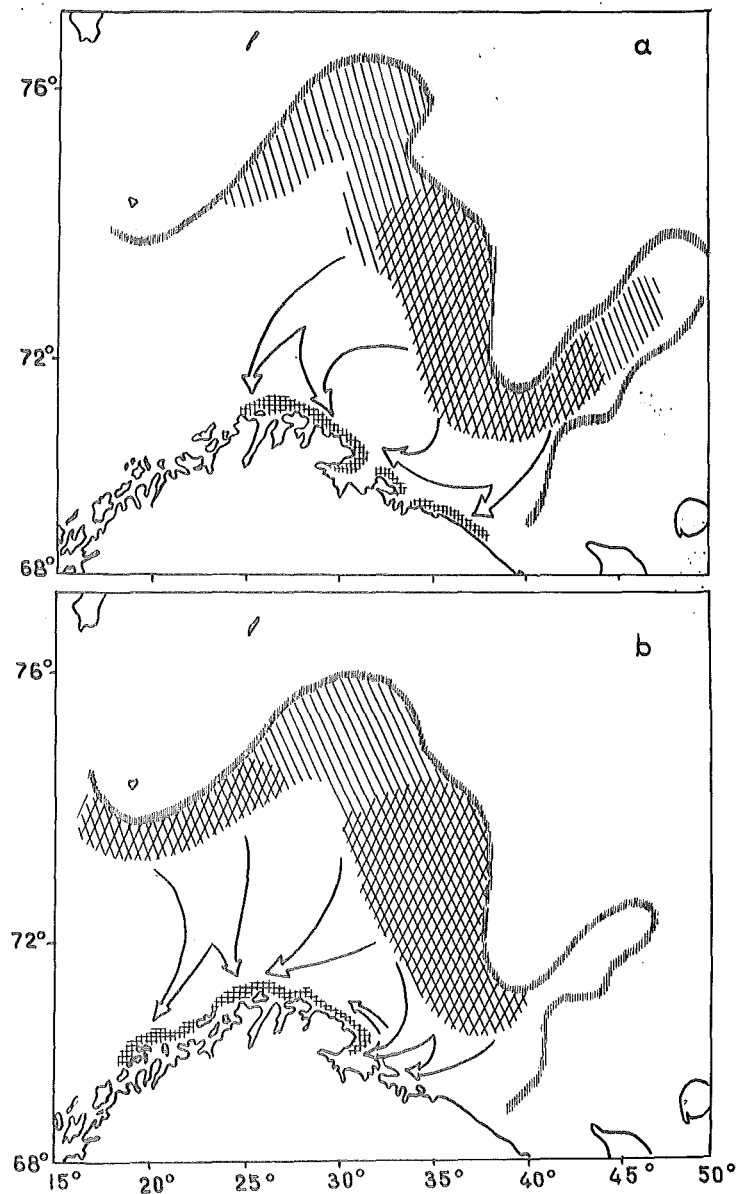


Fig. 7. Mature capelin concentrations (intersected shading) and main ways of capelin spawning migrations to the coast in January in warm (a) and cold (b) years. Areas of immature capelin concentrations are shown by oblique shading, areas of main spawning are indicated by fine rectangular shading.

In cold years in January, mature capelin concentrate mainly along the southern and eastern slopes of Bear Island Bank, in the extreme west of the Central Deep and in adjacent areas. Migrations flow from the southwest of the Central Deep to the north of Kildin and Rybachia Banks and to Varanger Peninsula. Fish from the Demidov Bank and Murmansk Tongue migrate to the Nordkyn Bank. Having wintered on the

southern and eastern slopes of Bear Island Bank, they cross the North Cape Current and reach the Norwegian coast, the Fugløy and Sørøy Banks and the western part of the Norwegian Deep. In cold years spawning migrations from the slopes of Goose Bank and adjacent areas are very weak or absent, as water temperature in these areas falls almost to 0°C by January. If capelin remain to spawn in these areas, when the water temperature becomes unfavourable in January, they have to migrate to the north-eastern slopes of the Murmansk Bank. In cold years the areas of mass spawning are displaced to the west and the main spawning occurs along the coasts of the Northern Norway from 18° to 31°E.

The position of the "spawning center", determined as the midpoint between the western and eastern borders of spawning grounds and expressed in degrees longitude, was used as the index of change of the spawning areas. Variations of this index are rather closely connected with the mean water temperature in the 0-200 m layer of three sections in the south-western Barents Sea (along the Kola Meridian; North Cape-Bear Island; and along 74° 30'N east of the Bear Island) in October-November of the preceding year. The correlation coefficient is 0,76. This supports the conclusion that the pattern of spawning migrations and spatial location of spawning grounds is generally determined by temperature conditions in the sea during the preceding winter.

Table 1 gives the time of capelin spawning migration to the coasts of Murman and the eastern Finnmark for 1971-1984. Comparing this with water temperature variations in the south-western Barents Sea in the same period (Fig. 1), we see that in warm years capelin come to spawn much later than in cold ones. Thus, in the warm years of 1973-1975 capelin approached the coast in a ten-day period during February-March, whereas in the cold years 1979-1981 they migrated as early as late January-early February.

The times of temperature minimum in the 0-200 m layer on the Kola Meridian and of the end of spawning on the Murman coast correlate well (Rodin, 1979), as do time of spawning and water temperature variations in the 0 - 200 m layer at station 1 of the same section (this report, Table 1). The correlation coefficient of the above indices for 1971-1983 is equal to 0.71 (with R/E=11). Consequently, the start of the seasonal rise in water temperature in spawning areas determines the end of mass spawning and the start of incubation of capelin eggs.

As mentioned, the location of mass spawning areas changes greatly depending on temperature conditions in the sea. Changes of temperature at Station 1 of the Kola Meridian partially indicate the thermal state of waters in spawning areas although the available data on the temperature minimum in areas of mass spawning may permit greater accuracy or correlation. The relationship between the time of onset of spawning and thermal conditions in the sea was not revealed.

4. Conclusion

Year-to-year fluctuations in the temperature regime of the Barents Sea produce a great effect both on the pattern of capelin migration at all stages of their life cycle and on the general position of the distribution area.

In warm years, the Barents Sea capelin penetrate farther northwards

and north-eastwards to feed than in cold years, reaching the extremities of the distribution area where they form commercial concentrations. In cold years the distance of northward and north-eastward migrations becomes much shorter. Variations of the distance, time of feeding migrations and formation of the commercial concentrations while feeding are connected with temperature conditions primarily via spring-summer production processes of zooplankton.

Overwintering concentrations form in the frontal zones, in warm years off the Hopen Island, Bear Island Bank, Central Elevation, as well as in the areas adjacent to the Goose Bank. In cold years no overwintering was observed in the eastern area because of the unfavourable temperature.

Spawning migrations of capelin depend both on temperature conditions in the southern Barents Sea and on the distribution of capelin during overwintering feeding and prior to spawning.

In warm years, the spawning migration proceeds mainly from the south of the Central Deep towards the Western Coastal area, Kildin and Rybachya Banks; from the extreme west of the Central Deep mature fish move to the coast of the eastern Finnmark. In cold years pre-spawning capelin move mainly to the Finnmark coasts from the southern and eastern slopes of the Bear Island Bank and from the extreme west of the Central Deep.

The position of the centre of capelin mass spawning is rather closely connected with variations of the thermal state of waters in the south-western Barents Sea in October-December of the preceding year.

The following changes in the distribution area of the Barents Sea capelin take place: in warm years it expands and move northwards and eastwards; in cold ones it becomes smaller and moves westwards and south-westwards.

5. References

- Buzeta, R., J. Hamre, M. Askland. 1976. Loddeundersøkelser i Barentshavet i juni 1975. Fisken og havet, 1:6-10. (In Norwegian).
- Degtereva, A.A. 1979. Regularities of quantitative development of zooplankton in the Barents sea. Trudy PINRO, 43:22-53 (In Russian).
- Dommasnes, a. 1978. Loddeundersøkelser i Barentshavet i juni-juli 1978. Fisken og havet, 4:49-64. (In Norwegian).
- Dommasnes, A., L. Midttun, T. Monstad. 1979. Loddeundersøkelser i Barentshavet vinteren 1978. Fisken og havet, 1:1-16. (In Norwegian).
- Gjøsæter, J., R. Sætre. 1973. Undersøkelser på loddas gytefelt i 1973. Fisken og havet, 3:4-7. (In Norwegian).
- Hamre, J., R. Sætre. 1976. Gyteinnsiget av lodde vinteren 1976. Fisken og havet, 2:43-51. (In Norwegian).
- Haug, A., T. Monstad. 1974. Loddeundersøkelser i Barentshavet i mai-juni 1973. Fisken og havet, 2:3-13. (In Norwegian).

- Johannessen, O.M., L.A. Foster. 1978. A note on the topographically controlled oceanic polar front in the Barents Sea. Journal of Geographical research, 83 (69):4567-4571.
- Luka, G.I., V.P. Ponomarenko. 1983. Seasonal and daily vertical migrations and structure of capelin concentrations in the Barents Sea. ICES C.M. 1983/H:27, p.1-16 (mimeo).
- Loeng, H. 1981. Nordlig utbredelse av lodde og temperaturforholdene i Barentshavet om høsten. Fisken og havet, 1:1-10. (In Norwegian).
- Loeng, H., O. Nakken, A. Raknes. 1983. Loddas utbredelse i Barentshavet i forhold til temperaturfeltet i perioden 1974-1982. Fisken og havet, 1:1-17 (In Norwegian).
- Martinsen, Yu.V. 1933. On the distribution of capelin (Mallotus villosus) in the Barents Sea. Trudy PINRO, 4(1):36-49 (In Russian).
- Prokhorov, V.S. 1965. Ecology of the Barents sea capelin and perspectives of their commercial exploitation. Trudy PINRO, 19, 68 p. (In Russian).
- Rodin, A.V. 1979. Effect of water temperature on time of capelin spawning. State of stocks and abundance dynamics of pelagic fishes of the World Ocean (abstract of reports to the All-Union conference), Kaliningrad, p.83 (In Russian).

Table 1. Dates of capelin approach to Murman and eastern Finnmark coasts for spawning, start and end of spawning and temperature minimum at Station 1 of the Kola Meridian.

| | Y E A R S | | | | | | | | | | | | | |
|---|-----------|--------|--------|--------|--------|--------|--------|--------|--------|--------|--------|--------|--------|--------|
| | 1971 | 1972 | 1973 | 1974 | 1975 | 1976 | 1977 | 1978 | 1979 | 1980 | 1981 | 1982 | 1983 | 1984 |
| Capelin approach for spawning | 1 Mar | 25 Feb | 19 Feb | 23 Feb | 7 Mar | 17 Feb | 18 Feb | 3 Mar | 7 Feb | 3 Feb | 23 Jan | 5 Feb | 10 Feb | 8 Feb |
| Start of spawning | 18 Ma | 6 Mar | 5 Mar | 22 Mar | 16 Mar | 13 Mar | 10 Mar | 2 Apr | 15 Mar | 20 Mar | 12 Mar | 14 Mar | 15 Mar | 16 Mar |
| End of spawning | 14 Apr | 21 Mar | 8 Apr | 10 Apr | 10 Apr | 21 Apr | 27 Apr | 25 Apr | 10 Apr | 16 Apr | 15 Apr | 14 Apr | 25 Mar | 26 Mar |
| Time of temperature minimum at station 1 of the Cola Meridian | 17 Apr | 26 Mar | 11 Apr | 21 Mar | 7 Apr | 6 Apr | 19 Apr | 19 Apr | 6 Apr | 15 Apr | 15 Apr | 11 Apr | 6 Apr | - |

**THE EFFECT OF THE THERMAL CONDITIONS OF THE SEA
AND ATMOSPHERIC CIRCULATION ON THE DISTRIBUTION
OF THE BARENTS SEA CAPELIN FEEDING AREAS.**

by

V.K. Ozhigin and N.G. Ushakov

Polar Research Institute of Marine Fisheries and Oceanography (PINRO),
6 Knipovich Street,
183763, Murmansk,
USSR.

ABSTRACT.

The influence of abiotic factors on the spatial distribution of the Barents Sea capelin is explored, using statistical analysis of the position of the northern limit of the capelin distribution in autumn, and some parameters describing the thermal condition of the sea and the atmospheric circulation.

1. INTRODUCTION

Spatial distribution of the Barents Sea capelin in a period of feeding is determined by a number of natural factors. The most important of these are, apparently, the thermal conditions of the sea and the condition of the nutritive base.

Feeding capelin follow the concentrations of food zooplankton, transported by a system of currents from the areas of their generation to the northern and northeastern sea areas. Fish tend to concentrate in the areas where a rich nutritive base is conjoined with favourable temperature conditions (Luka, 1978). Formation of the zooplankton fields and their spatial distribution results in turn from the thermal conditions in the spring and summer and the hydrodynamic conditions. In warm years zooplankton are transported by the currents considerably farther to the north and northeast than in cold years (Panasenko, 1978; Drobysheva, 1979). Zones with temperature conditions favourable for capelin are similarly displaced.

According to annual acoustic estimations of the capelin stock, it was registered that cooling had a marked effect on the feeding range. Beginning in 1977, a gradual displacement to the southwest of the capelin feeding range took place throughout a number of cold years and it was shown that the position of the zero isoline of capelin density, indicating the northern limit of the feeding area, is well correlated with the isotherm of 0° at the 100 m depth (Loeng, 1981; Loeng, Nakken and Raknes 1983).

Thus, the higher the water temperature is in spring-summer, the farther feeding capelin concentrations will be displaced in a north or northeasterly direction. However, this seems to occur only when the velocity of water motion, carrying heat and zooplankton to the northern sea areas, remains close to "normal". Large disturbances in water circulation profoundly influence the distribution of zooplankton, and, hence, the distribution of feeding capelin concentrations.

The largest concentrations of zooplankton were naturally located over the pycnocline, which occurs at 20-50 m depths in the areas of capelin feeding (Rodin, 1977; Luka, 1978).

At such shallow depths, the water mass and the plankton, contained in it, are affected by drift currents. An increase in wind frequency from the northeast can prevent warm water and plankton entering the northern and northeastern areas of the sea. Atmospheric circulation can thus cause essential variations in thermal condition of waters and affect the capelin feeding distribution (Rodin, 1983). Therefore the assessment of the atmospheric circulation over the sea area in spring-summer is necessary to determine the location of plankton fields, and, hence, the spatial distribution of feeding capelin.

* Warm (cold) periods should be regarded as the years, seasons, month etc., in which anomalies of water temperature in basic sections in the southwestern Barents Sea exceed $+0.3^{\circ}\text{C}$ (-0.3°C). Periods, when the anomalies of water temperature are within -0.3°C to $+0.3^{\circ}\text{C}$, should be considered as transitional years.

This paper discusses the influence of abiotic factors on the distribution of feeding capelin.

2. MATERIALS AND METHODS

The results of the joint Soviet-Norwegian acoustic surveys on capelin stock assessment, carried out annually in September-October 1973-1982, were used as the basic data of this paper. The zero isoline, indicating the northern limit of capelin feeding areas (NBFAC), was drawn in the chart of the density distribution of capelin.

Six transects, with 60-mile intervals around 77° N and running southwest to northeast were chosen to numerically present the position of feeding ground displacement (Fig. 1). One axis runs along 35° E. The direction of the transects was chosen to provide an intersection with zero isoline of capelin density, which was as close as possible to a right angle.

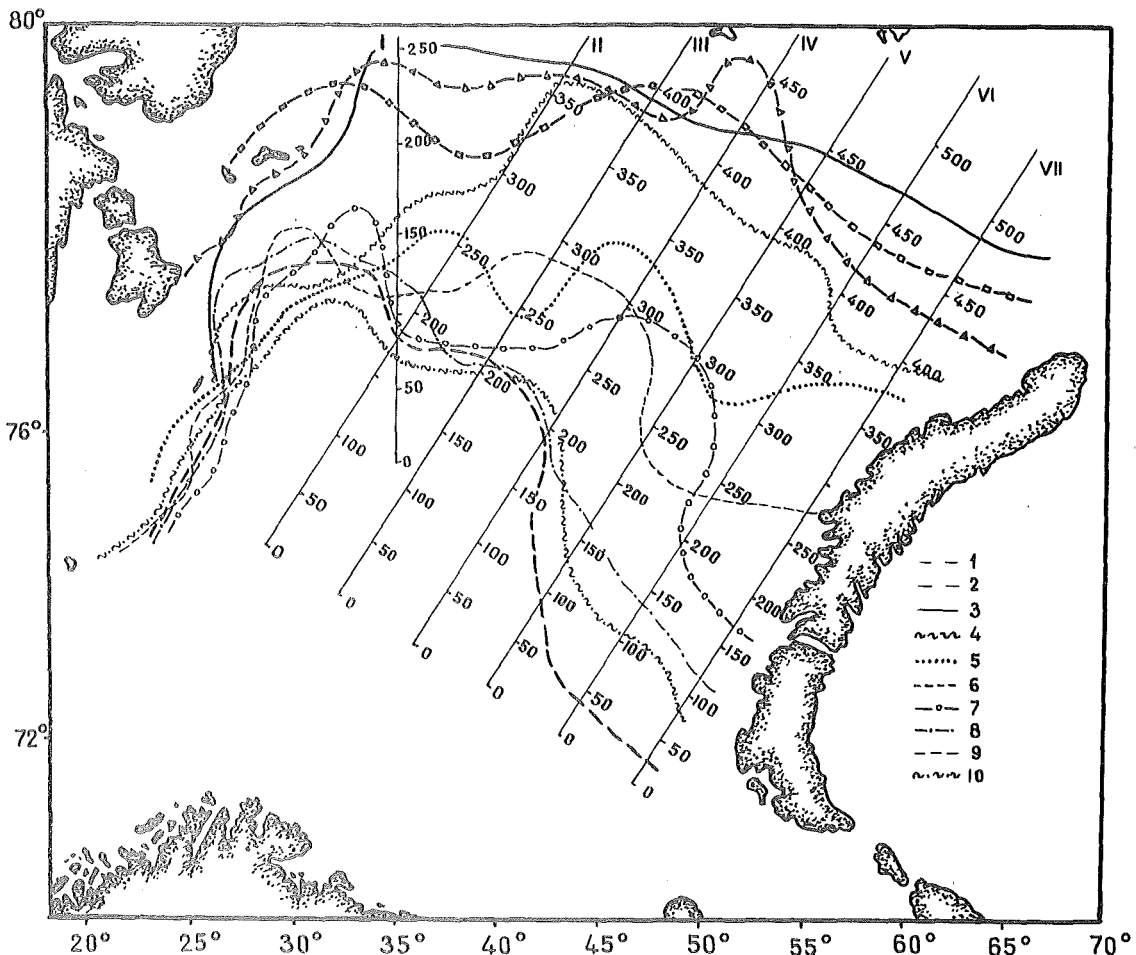


Fig. 1. Position of the northern border of feeding area of capelin: 1-1973; 2-1974; 3-1975; 4-1976; 5-1977; 6-1978; 7-1979; 8-1980; 9-1981; 10-1982 and position of effective transects in the Barents sea area.

Small bends of less than 30 miles were smoothed out on the zero isolines of capelin density. The position of the northern border of

the feeding area according to each survey is expressed as the distance in miles from the beginning of the transects to the point of intersection with the isoline of zero density. Time series, characterizing variations of the NBFAC position on each axis for 10 years, were obtained according to this method.

Mean surface temperature (X_1) of 10 stations, from standard sections located approximately equidistant from each other, were used as an index of surface thermal conditions of the southwestern Barents Sea. In addition to this index, the mean temperature of water at 0-200 m (X_2) and at 0-50 m (X_3) on the Kola Meridian section in April-June, at 0-200 m on section 2³ in April-June (X_4), and on section 3 in October-March (X_5) and the averaged water temperature of three sections (3, 6, 2⁹) at 0-200 m in June-July (X_6) were recorded.

The difference in the atmospheric pressure between the Vaida Bay station and Bear Island in April-June (X_7) and average monthly frequency of northeasterly winds (in %) in April-June (X_8) and in January-June (X_9) were assumed to characterize the atmospheric circulation.

3. RESULTS

All the indices characterizing the NBFAC position, the thermal condition of the sea and the atmospheric circulation, were statistically analysed. Coefficients of pair correlations of these parameters are presented in Table 1. As is seen from the table, all the temperature indices were closely correlated with the variations of the NBFAC position with r varying from 0,58 to 0,92* for different axes. Variations of the difference of atmospheric pressure between the Vaida Bay station and Bear Island are poorly correlated with the variations of NBFAC ($r=0,22-0,45$). Average monthly frequency of northeasterly winds and variations of the NBFAC position are inversely correlated ($r=-0,59 - -0,74$).

Table 1. Coefficients of pair correlation of hydrometeorological indices with the NBFAC position on different effective axes.

| Hydrometeorological indices. | The NBFAC position on effective axes | | | | | | |
|------------------------------|--------------------------------------|-------|-------|-------|-------|-------|-------|
| | I | II | III | IV | V | VI | VII |
| X_1 | 0.76 | 0.77 | 0.75 | 0.71 | 0.70 | 0.70 | 0.70 |
| X_2 | 0.86 | 0.87 | 0.78 | 0.70 | 0.67 | 0.73 | 0.76 |
| X_3 | 0.90 | 0.92 | 0.85 | 0.78 | 0.74 | 0.80 | 0.83 |
| X_4 | 0.84 | 0.83 | 0.77 | 0.68 | 0.66 | 0.67 | 0.68 |
| X_5 | 0.86 | 0.86 | 0.77 | 0.69 | 0.65 | 0.70 | 0.73 |
| X_6 | 0.76 | 0.73 | 0.71 | 0.63 | 0.61 | 0.58 | 0.59 |
| X_7 | 0.22 | 0.25 | 0.23 | 0.36 | 0.38 | 0.45 | 0.43 |
| X_8 | -0.59 | -0.62 | -0.64 | -0.70 | -0.72 | -0.72 | -0.67 |
| X_9 | -0.61 | -0.64 | -0.65 | -0.69 | -0.72 | -0.74 | -0.69 |

* Correlation coefficients for available frequencies are reliable at the significance level $p=0,10$ if they exceed 0,55.

The effect of abiotic factors on the distribution of capelin

It should be noted that between the indices of the thermal condition of the sea and the average monthly frequency of the northeastern winds there is a weak inverse relationship ($r=-0,23 - -0,41$).

Thus, the statistical analysis showed that the main contributor to the spatial distribution of feeding capelin was the thermal condition of the sea and the atmospheric circulation in spring-summer.

The combinations of temperature indices, circulation indices and the NBFAC position which give coefficients of multiple correlation exceeding 0.8, were determined for each of the effective axis according to Ivahnenko and Lapa, (1975). Because an increase in the number of correlating parameters increases the multiple regression coefficient, and decreases relationship stability, we tried to find the combinations with a minimal number of parameters, which would provide sufficiently high coefficients of multiple regression. After determining these combinations, the equations, characterizing the NBFAC position on each of the transects, were obtained using regression analysis.

$$\begin{aligned}
 (1) \quad Y_I &= -88.35X_2 + 182.54X_3 - 17.21X_8 - 73.55. \\
 (2) \quad Y_{II} &= -110.17X_2 + 227.50X_3 - 24.69X_9 - 34.55 \\
 (3) \quad Y_{III} &= 265.17X_3 - 227.97X_5 - 23.26X_8 + 645.18 \\
 (4) \quad Y_{IV} &= 87.65X_1 + 70.07X_7 - 38.43X_8 + 214.64 \\
 (5) \quad Y_V &= 127.11X_7 + 143.60X_6 - 58.73X_8 + 23.23 \\
 (6) \quad Y_{VI} &= 138.07X_4 + 141.33X_7 - 56.48X_8 + 252.65 \\
 (7) \quad Y_{VII} &= 170.97X_3 + 135.77X_7 - 55.77X_8 + 10.28
 \end{aligned}$$

where Y_i = the NBFAC position on the axes I-VII;

$X_1 - X_9$ = hydrometeorological indices;

Proceeding from the assumption that the results of calculation on these equations have been done about 2 months in advance, possible error was assumed to be equal to $0,674 \sigma$. The ratio of the mean squared error of the calculated value to the mean squared deviation of the predicted value ($S/\sigma=0,57$) was used as an index of the reliability of obtained relations (Manual of forecast service, 1975). The nearer the value of this ratio is to zero, the more effective is the relationship.

The values of multiple regression coefficients, the ratios of S/σ , and the possible errors of calculations (δ) are presented in Table 2. The data of the table show that the S/σ ratio is considerably lower than 0,57 for all the equations.

Table 2 Multiple regression coefficients (R), ratios S/σ and possible errors (σ , in miles) for the equations on the transects I-VII.

| Statistical parameters | Equations of transects | | | | | | |
|------------------------|------------------------|------|------|------|------|------|------|
| | I | II | III | IV | V | VI | VII |
| R | 0.96 | 0.97 | 0.93 | 0.93 | 0.96 | 0.95 | 0.97 |
| S/σ | 0.28 | 0.24 | 0.35 | 0.36 | 0.25 | 0.29 | 0.24 |
| δ | 42 | 51 | 56 | 62 | 84 | 98 | 109 |

As a whole, the NBFAC position is determined by the results of separate calculations, carried out for each of the transects. The ratio of the number of transects on which the calculations were reliable, to the total number of transects, was the index of confidence.

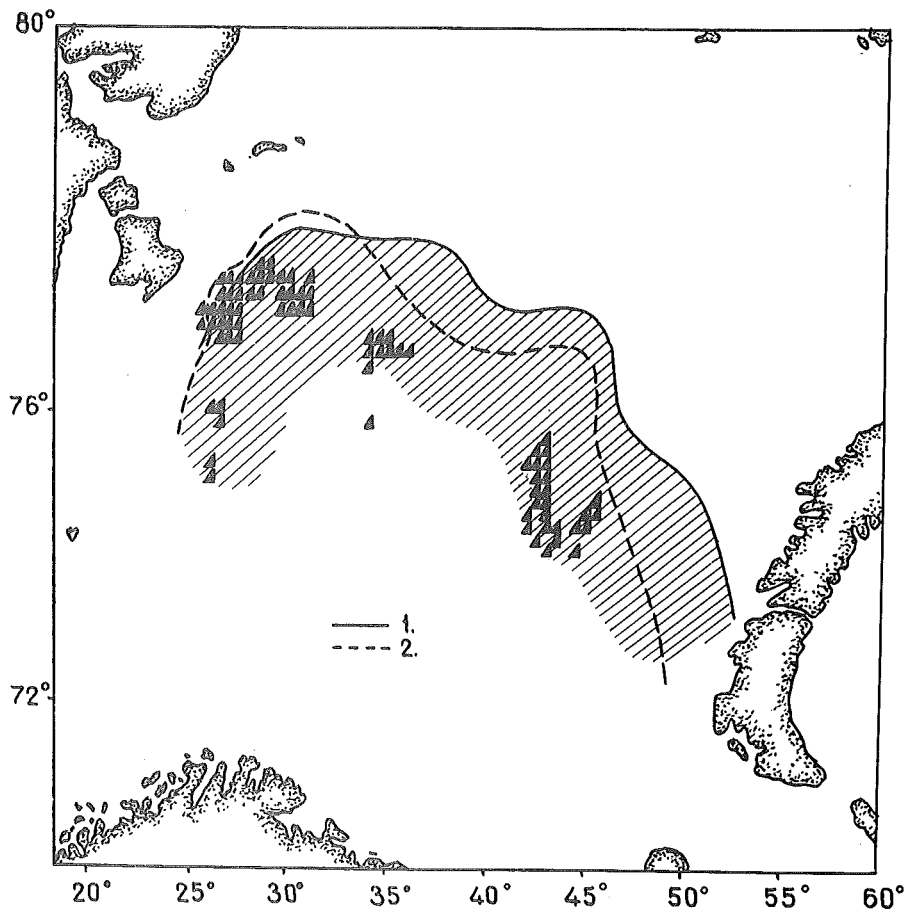


Fig. 2. Calculated (1) and actual (2) position of the northern border of the feeding area of capelin in 1983. The zone of probable distribution of the main capelin concentrations is shaded. Triangles indicate the actual areas of distribution of the main fish concentrations.

4. CONCLUSIONS AND DISCUSSION

As a rule, fish of older age groups are known to occupy the most northern part of the feeding area (Loeng 1981) in a zone about 100-150 miles wide. In this case, it should be noted that as the amplitude of year-to-year variations of the NBFAC position increased from west to east, the value of possible errors- from 42 miles on the axis I to 109 miles on the axis VII increased correspondingly (Fig. 2).

Checking the results with dependent materials showed that 90% of estimates proved to be reliable for each of the seven transects. Calculations on independent materials for 1983, presented in Fig. 2, indicated good correspondence between the estimated and actual position of the NBFAC. In Fig. 2, a zone 100 miles wide, adjacent to the northern limit and calculated for September-October 1983, is presented by shading. All the areas in which the main capelin concentrations were actually distributed in that period are included in this zone. Thus, the method to delineate NBFAC, allows prediction of this area by about 2 months enabling the main effort of joint investigations on capelin stock estimation to be concentrated in the effective zone.

The method considered here allows determination of the position of the NBFAC in the areas east of 35° E. Climatological analysis gives good results for western sea areas, i.e. the data of norm, but variations of the NBFAC position are not significant in these areas. Because of lack of necessary materials, determination of the position of capelin concentrations off the South Cape Deep was not possible.

5. REFERENCES

- Drobysheva, S.S. 1979. Formation of the Euphausiacea concentrations in the Barents Sea. Trudy PINRO, Murmansk, 43:54-76 (In Russian).
- Ivahnenko, A.G. and V.G. Lapa 1975. Forecasting of accidental processes. Naukova dumka, Kiev, 310 p (In Russian).
- Loeng, H. 1981. Nordlig utbredelse av lodde og temperaturforholdene i Barentshavet om høsten. Fisken og Havet, 1:1-10. (In Norwegian).
- Loeng, H., O. Nakken, and A. Raknes 1983. Loddas utbredelse i Barentshavet i forhold til temperaturfeltet i perioden 1974-1982. Fisken og Havet, 1:1-17. (In Norwegian).
- Luka, G.I. 1978. Utilisation of data on hydrometeorological factors in operational scouting research of capelin in the Barents Sea. Trudy PINRO, Murmansk, 41:36-43 (In Russian).
- Manual on forecast service. 1975. Part III. Service on marine hydrological forecast. L. Gidrometizdat, 136 p (In Russian).
- Panasenko, L.D. 1978. Long term variations of food composition and stomach fullness of capelin. Trudy PINRO, 41:44-52 (In Russian).

- Rodin, A.V. 1977. Influence of environmental conditions and nutritive base on feeding capelin behaviour in the Barents Sea. Voprosy promyslovoy okeanologii Mirovogo okeana, (Theses of the All-Union Conference Report on fishing oceanology), Murmansk, 112 p (In Russian).
- Rodin, A.V. 1983. Peculiarities of atmospheric circulation and distribution of feeding capelin concentrations in the Barents Sea. Vestnik LGY, 18:94-96 (In Russian).

ON DENSITY OF DISTRIBUTION AND ORIENTATION OF CAPELIN SCHOOLS

by

L. I. Serebrov

Polar Research Institute of Marine Fisheries and Oceanography (PINRO),
6 Knipovich Street,
183763 Murmansk,
USSR

ABSTRACT

The density and structure of capelin schools were studied using underwater automatic photcameras from a distance of less than 2 m during feeding migrations in the Barents Sea and Northwest Atlantic.

In the daytime the density of schools was below 15-20 spec./m³ averaging 1.42 spec./m³, while at night it was no higher than 3.5 spec./m³ averaging 0,84 spec./m³.

Within schools fish were usually joined in subgroups of 3-5 individuals separated by an average distance of about 3 body lengths. When fish are separated by less than 3 body lengths, the relative bearing is about 54° and at larger distances it decreases to 49°.

Quickly moving schools condense by moving subgroups or, rarely, individual fish in the subgroups closer together.

1. INTRODUCTION

Regular spacing and common orientation are the attributes of fish schooling behaviour peculiar to most pelagic species and, in particular, to capelin *Mallotus villosus* Müller (Gerasimov, 1983).

The knowledge of regularities of schooling behaviour of any fish species is significant for comprehending the mechanisms of its adaptation both to environmental and fishery effects. Data on spatial structure of schools may be additionally applied to improve acoustic methods for stock assessment, to increase the fishing efficiency etc.

2. MATERIAL AND METHODS

The structure of capelin schools during feeding migrations in the Barents Sea and Northwest Atlantic (Fig. 1) was studied by means of photogrammetric processing of the photographs taken by the "Triton" automatic cameras.

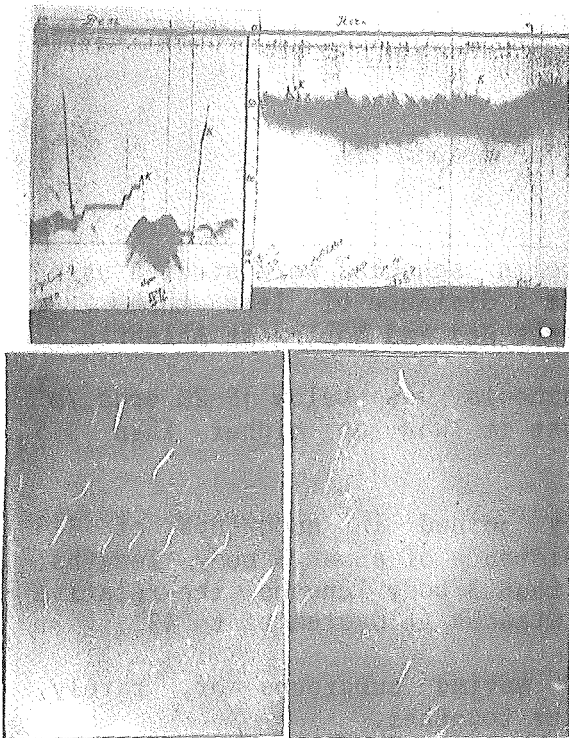


Figure 1. Echogram of capelin schools in the daytime (A) and at night (B). K - camera.

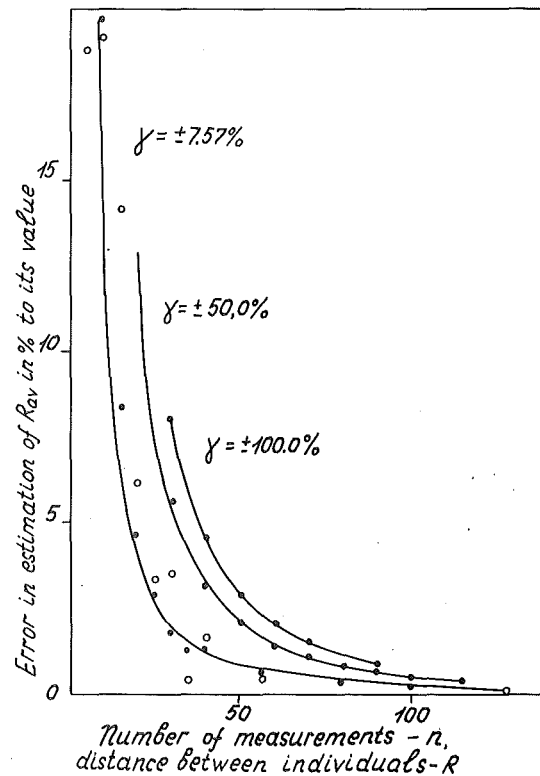


Figure 2. Relationship between error ($m_{R_{av}}$) of distance between fish and variation of fish size frequency γ and number of measurements.

On density of distribution and orientation of capelin schools

The school density was determined by the methods described by Serebrov, (1973, 1974) and Serebrov et al., (1975). A total of 229 photographs were analysed.

To study the relative positions of fish by the method of photogrammetric coordinates 16 photographs were analysed, 9 of which were taken in the daytime and 7 at night. The distance R between each pair of specimens was determined by the difference between their three-dimensional coordinates x, y, z and x_1, y_1, z_1 :

$$R = [(x - x_1)^2 + (y - y_1)^2 + (z - z_1)^2]^{1/2} \quad (1)$$

Of all values of R determined for each fish, the lowest one corresponded to the distance from the nearest neighbour.

The scale of each image in the photograph, the distance to the camera and coordinates were determined by the correlation between the fish length in the photograph and the average fish length in catches. The probable error in the evaluation of spatial coordinates was close to the variation γ of fish length in catches, i.e. to the standard deviation in % of the average body length. The approximate error of the distance between fish; $m_{R_{av}}$ was estimated by simulation and amounted to

$$m_{R_{av}} \approx \frac{\gamma}{\sqrt{2n}} \quad (2)$$

The corresponding relationship between the error $m_{R_{av}}$ and the number of measurements, with the variation ranging from 7.75% to 100.0% is shown in Fig. 2.

Probable errors of distances between fish were taken into account while analysing the reliability of measurements.

The data were treated by special programmes developed for the MIR-2 computer.

3. RESULTS

During the initial treatment of the data it was found that fish maintained a relatively constant distance to the camera regardless of school density (Fig. 3). Beyond this range (Zaferman, 1965) no anomalies in fish distribution were observed.

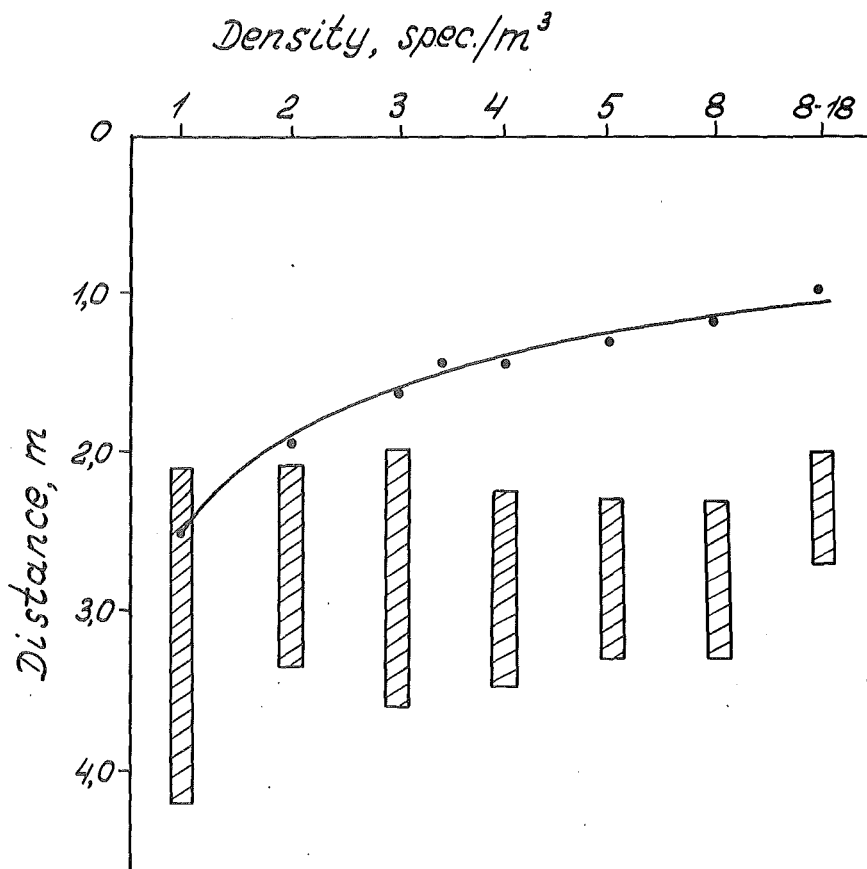


Figure 3. Distance from the camera to fish aggregation in the surveyed area. The curve demonstrates expected distances from the camera to the nearest fish at different densities.

Both day and night, the density of schools varied after the law of log normal distribution, with those of less than 1 spec./m³ density being the most frequent (Fig. 4).

In daytime the density of some apparently actively migrating schools (Gerasimov, 1983; Zaferman, 1965; Zaferman, 1972) approached 4-20 spec./m³ and was generally higher than at night (Table 1) with the 95% confidence level.

Table 1. Density of capelin schools during day and night.

| Time | Number of observations | Average density, spec./m ³ $\bar{\rho}$ | Standard deviation σ | Variation $\gamma \%$ | Error of the mean $m \%$ |
|-------|------------------------|---|--------------------------------|--------------------------|-----------------------------|
| Day | 191 | 1.425 | 2.3 | 161.4 | 11.6 |
| Night | 38 | 0.84 | 0.74 | 88.3 | 14.2 |

On density of distribution and orientation of capelin schools

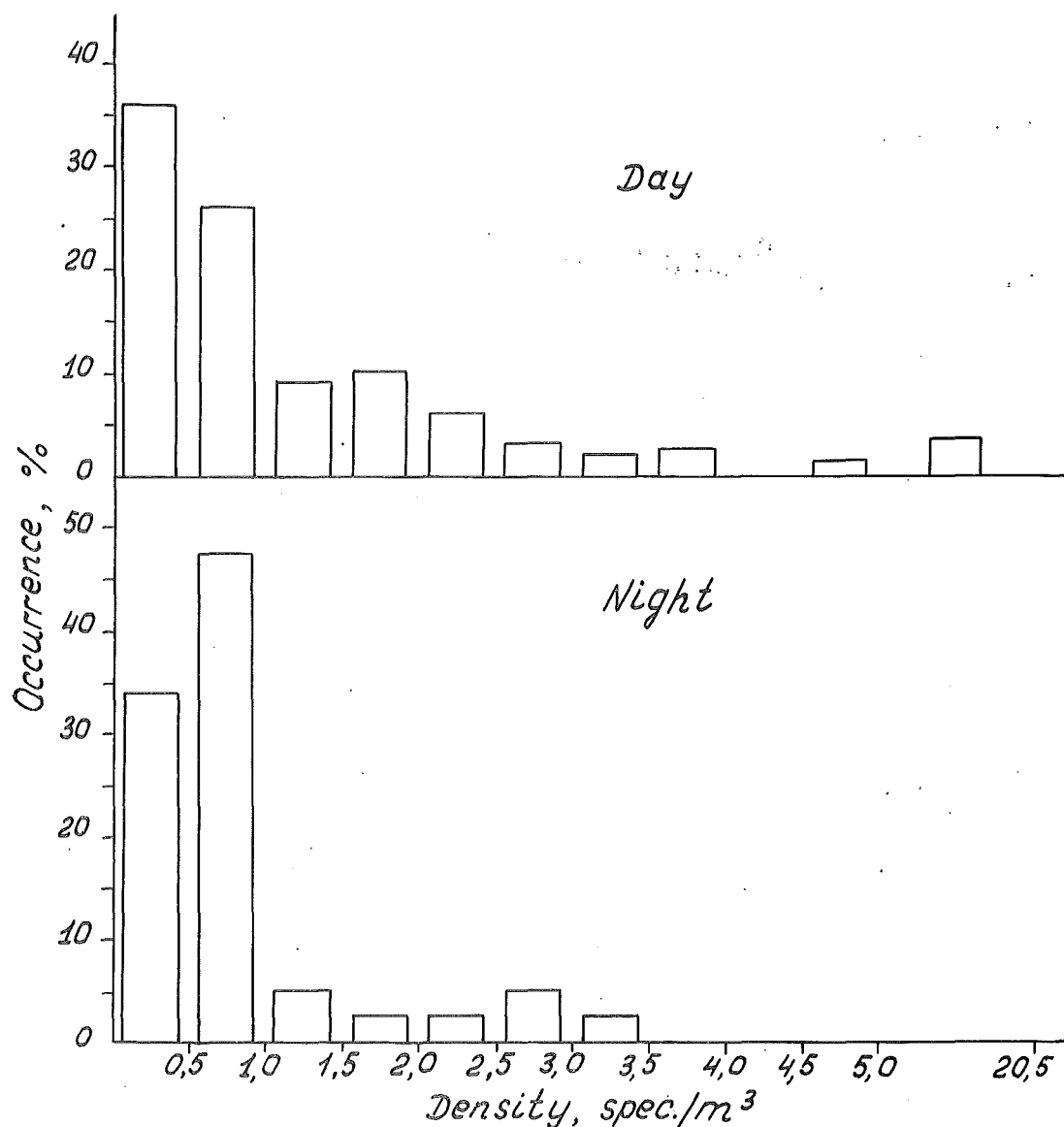


Figure 4. Frequency distribution of schools of various densities.

There were no significant differences between the values of school density estimated by photographic and by acoustic methods, but variations of acoustic estimates were much lower due to the larger amount of fish sampled.

Measurement of the distance between each fish to its nearest neighbour showed that only in about 20% of cases do fish form an isolated pair of nearest neighbours. However, it was more often observed that a subgroup of mutually adjacent neighbours was formed, usually consisting of 3-4 fish in the daytime and up to 5-7 fish at night (Table 2).

Table 2. Distances between nearest neighbours and frequency of occurrence of subgroups of different sizes.

| Time | | Number of fish in a subgroup | | | | |
|-------|--------------------------------------|------------------------------|------|------|------|------|
| | | 2 | 3 | 4 | 5 | 7 |
| Day | Mean distance between neighbours (m) | 0.47 | 0.44 | 0.50 | 0.4 | - |
| | Occurrence (%) | 20.5 | 34.1 | 22.7 | 22.7 | - |
| Night | Mean distance between neighbours (m) | 0.72 | 0.96 | 1.2 | 0.98 | 0.65 |
| | Occurrence (%) | 16.6 | 25.0 | 8.3 | 20.8 | 29.2 |

The school was divided into separate subgroups of nearest neighbours whose absolute density was several times higher than the average absolute density of the school (Table 3).

Table 3. Relationship between density of subgroups and total density of the school.

| Time | School | | Subgroups | | Ratio of densities Subgroup: School |
|-------|-----------------------|--|------------------------|--|---|
| | Number of photographs | Average density ₃ spec./m ³ q | Number of measurements | Average density ₃ spec./m ³ q | |
| Day | 9 | 0.949 | 198 | 18.8 | 19.81 |
| Night | 7 | 0.681 | 47 | 2.6 | 3.82 |

In the daytime subgroups of 3-4 spec. were most frequent, agreeing with the results of the experiments carried out by Darkov (1975) who showed that schooling interactions become effective with such amount of specimens.

Thus, interactions of schooling fish seem to be performed on two levels: between fish in a subgroup of 3-4 specimens and between subgroups in a school. This concurs with Lebedev's (1967) theory in which true schooling is characterized by the availability of group contact not only between individuals but also between groups of fish within a school. A similar structure was observed earlier in juvenile saithe, *Pollachius virens* L., during the experiments in the tank (Patridge, 1981).

The analysis of spacing measurements between nearest neighbours in the daytime (Fig. 5) showed that with inter fish distance (R) ranging from

On density of distribution and orientation of capelin schools

0.6 body lengths (≈ 10 cm, point a) to 5 body lengths (≈ 76 cm, point i) these distances range around the average value of 3.04 body lengths (46.2 cm, point d) after the law of normal distribution; have a mode with $R = 2.2$ body lengths (33.5 cm, point c) and a well-pronounced peak of occurrence with $R = 1.5$ body lengths (23 cm, point b). The variation index of distribution was 33.2 % exceeding the variation index of fish length frequency (7.6 %) in the catch by a factor of 4. With $R > 5$ body lengths in daytime, and also with any value of R at night, no systematic difference in distances between nearest neighbours was observed. This suggests an absence of schooling interactions at night as well as in the daytime when they are more than 5 body lengths distance from each other.

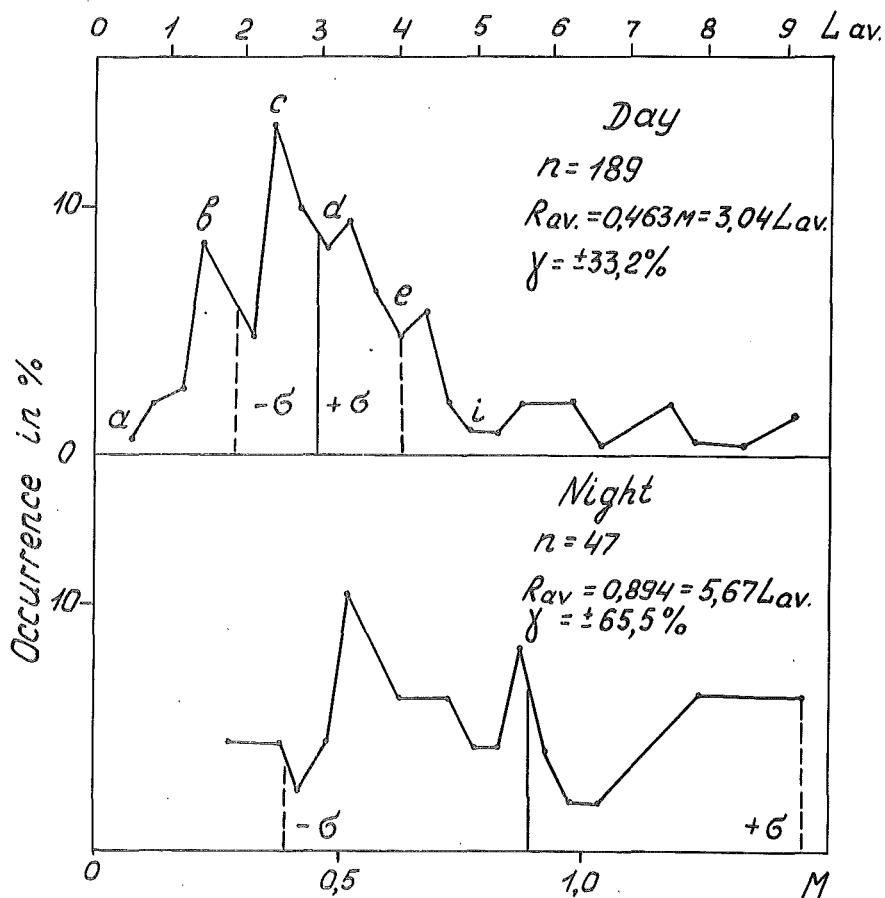


Figure 5. Average distances between nearest neighbours in subgroups. Alphabetical symbols indicate points on the curve that are referred to in the text.

Variation of the distance between nearest neighbours indicates that individuals in the school tend to maintain optimal distance of 2-3 body lengths but this can vary from 0.6 to 5 body lengths. Beyond this range, school interactions are hampered.

In order to verify the assumption that fish seek to optimize ambient hydrodynamics, average relative bearings between neighbours were counted for intervals less and more than 3 body lengths (Fig. 6 and 7). As is seen from the figures, with $R < 3$ body lengths the average relative bearing coincides with that predicted by Shuleykin, (1968) ($54^{\circ} 24'$) whereas with $R > 3$ body lengths it was somewhat lower than expected (49°).

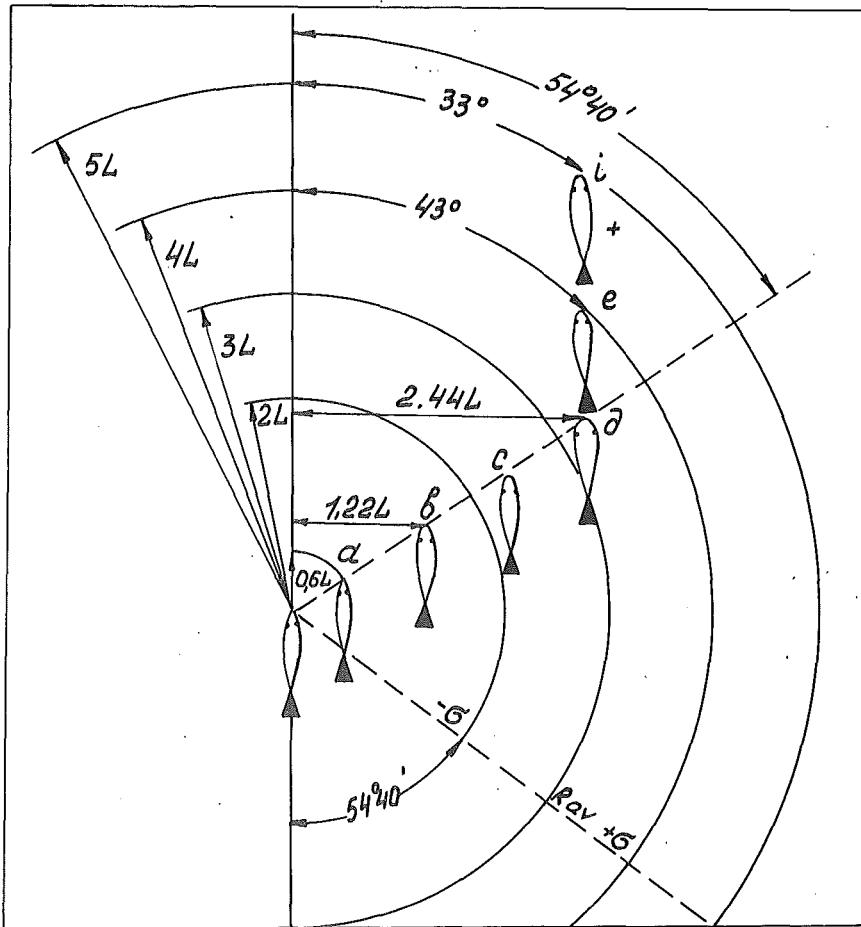


Figure 6. Bearings relative to nearest neighbours in the subgroup in the horizontal (top) and vertical (bottom) planes at different distances between fish.

Thus, if specimens move at a distance up to 5 body lengths from each other, then the distance may be maintained with no decline in optimal bearing. At distances greater than 5 body lengths, vortex energy dissipates and bearing is irrelevant.

It should be noted that when the distance between fish equals 1.22 body lengths (point b) vortices from neighbouring fish will provide, according to Belyaev and Zuev, (1969), conditions for the best flow of bodies moving in water. This seems to account for the peak in point b on the distribution curve (Fig. 5).

The density of subgroups with the mean distance between fish of about 3 body lengths, (point d in Fig. 5), corresponds to the maximum density of schools observed - 10-20 spec./m³.

On density of distribution and orientation of capelin schools

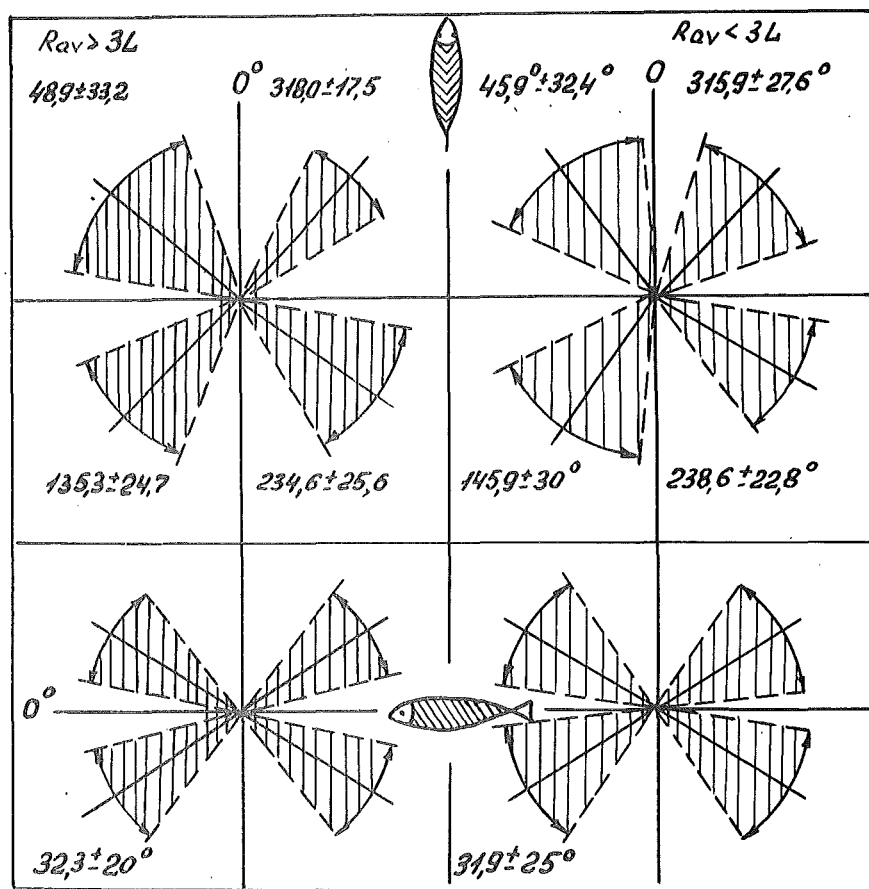


Figure 7. Real relative bearings between nearest neighbours brought together in two quadrants.

4. DISCUSSION

The two levels of group interactions in fish schools are brought about, apparently, by specific biological functions of schooling behaviour on each of these levels. In particular, it is evident that the hydrodynamics permitting fish to swim with a lower energy consumption are created by interaction with nearest neighbours within an elementary subgroup. The same adaptive functions of schooling behaviour can be realized on the level of these subgroups, and facilitate such things as search and consumption of food, protection against predators, coordinated movement during migrations etc.

According to Belyaev and Zuev (1969), optimal distance between neighbours in a moving school may be based on group hydrodynamics, where the interaction of vortex trails and the distance between the trajectories of migrating fish result in an average distance of 2.4 body lengths (Serebrov, 1976). According to Shuleykin's (1968) hypothesis, optimal swimming may be obtained at about $54^\circ 40'$ to the nearest neighbour.

Proceeding from these hypotheses, let us try to conceive mutual positions of two nearest neighbours in the school (Fig. 8), if the intervals between them correspond to points a, b, c, d, e and i on the distribution curve (Fig. 5).

Fig. 8 shows that with the optimal relative bearing of $54^{\circ}40'$ and the mean interval between fish amounting to 3.04 body lengths (point a), the distance between fish tracks will be 2.44 body lengths, i.e. under these conditions the group hydrodynamic effect may be manifested.

With the nearest neighbour in point b ($R = 1.5$ body lengths), the distance between fish tracks will be half of the above value, i.e. 1.22 body lengths.

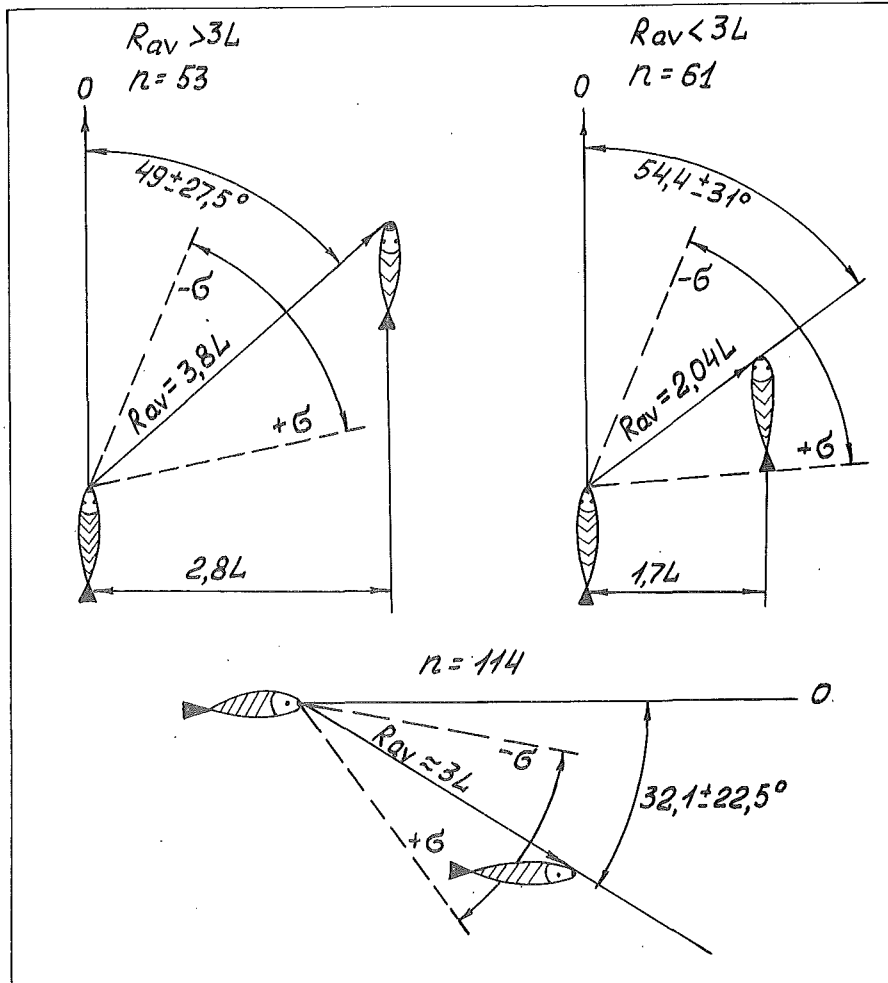


Figure 8. Versions of possible positions of nearest neighbours in the subgroup with different distances between them. For alphabetical symbols, see Fig. 5.

The distance valid for effective interactions of vortex trails from neighbouring fish equal to 2.44 body lengths may also be preserved when the interval between neighbours is above the average value 3.04 body lengths, but in this case relative bearings should be below the optimal angle $54^{\circ}40'$ (Fig. 6, points c and i).

A frightened group of fish accelerates its swimming speed and, consequently, becomes compact. It may well be that in this case mean distances between fish diminish and tend to $R = 1.5$ body lengths, corresponding to the best flow-past conditions (point b in Figs. 5 and 6). In particular, it was shown earlier for juvenile minnow (Serebrov, 1978) that when fish are frightened this distance declines from 1.9 body lengths to 1.36 body lengths and, correspondingly, the density

On density of distribution and orientation of capelin schools

A still higher density of schools is biologically unreasonable and may occur, apparently, under artificial conditions, e.g. in gears, reservoirs, tanks etc.

6. REFERENCES

- Belyaev, V.V., and G.V. Zuev, 1969. Hydrodynamic hypothesis of fish school formation. Vopr. Ikhtiolog., 9, 4(57):716-725. (In Russian).
- Buyakas, V.P., A.A. Darkov, and P.V. Radakov, 1978. Mathematical model of fish school motion. Vopr. Ikhtiolog., 18, 5(112):924-934. (In Russian).
- Cullen, J.M., E. Show, and H.A. Baldwin, 1965. Methods for measuring the three-dimensional structure of fish schools. Animal Behaviour, 13.
- Darkov, A.A., 1975. Behavioural reactions of schooling fish on specimens of the same species and the problem of school formation. Vopr. Ikhtiolog., 15, 4(93):763-766. (In Russian).
- Gerasimov, V.V., 1983. Ecological-physiological regularities of fish schooling behaviour. Nauka Press, 125 pp. (In Russian).
- Lebedev, N.V., 1967. Elementary populations of fish. Pishchevaya promyshlennost, 212 pp. (In Russian).
- Patridge, B.L., 1981. Internal dynamics and interrelations of fish in schools. J. Comp. Physiol., 3
- Serebrov, L.I., 1973. Utilization of underwater automatic photcamera to investigate the behaviour of bottom fishes. Rybnoje khozjajstvo, 7:52-54. (In Russian).
- Serebrov, L.I., 1974. Utilization of quantitative methods to investigate the behaviour of commercial bottom fishes. Rybnoje khozjajstvo, 9:14-16. (In Russian).
- Serebrov, L.I., 1976. Relationship between school density and fish length. Vopr. Ikhtiolog., 16, 1(96):152-157. (In Russian).
- Serebrov, L.I., 1978. Distribution of young minnow (Phoxinus phoxinus L.) in mobile and immobile schools. Vopr. Ikhtiolog., 18, 3(98):565-568. (In Russian).
- Serebrov, L.I., V.S. Bakanev, and A.S. Seliverstov, 1975. Instrumental estimation of the Newfoundland stock of capelin. Rybnoje khozjajstvo, 10:13-16. (In Russian).

On density of distribution and orientation of capelin schools

- Shuleykin, V.V., 1968. Physics of the sea. Nauka Press, 1083 pp. (In Russian).
- Zaferman, M.L., 1965. On the influence of objects suspended in water on behaviour of some fish species. In: Materials of fishery research in the northern basin, Murmansk, 185-187. (In Russian).
- Zaferman, M.L., 1972. Observations over capelin in the Hopen Island area. In: Materials of fishery research in the northern basin, Murmansk, PINRO, 93-101. (In Russian).

increases by a factor of almost 3, agreeing with the above assumption.

The interactions between fish also determine such attributes of subgroups as viscosity and elasticity (Buyakas et al., 1978). With the distance between fish below one body length their manoeuvring becomes limited, and the efficiency of hydrodynamic interaction may decline. Thus the mean distances between fish equal to 0.58 body length observed during the experiments on herring kept in a tank (Cullen et al., 1965) should not be related to schools under natural conditions. Direct measurement of distances between neighbours in the subgroup confirmed the above assumption (Serebrov, 1976) that distance in body length ranges around some optimal value dependent on hydrological factors. However, it has become evident that positions of fish in the subgroup differ fundamentally from spacing of points in the cube-shaped lattice, as far as bearings relative to the nearest neighbour approximates, as is seen from measurements, not to 90° but to 54° . Consequently, proceeding from the cubic model, the ratio of the density of the subgroup ρ and the mean distance from each fish to the nearest neighbour R_{av}

$$R_{av} = \rho^{-1/3} \quad (4)$$

should be considered not reliable.

The expected mean distance between fish calculated on the basis of the cubic model of distribution following formula (4) and the data on length composition of fish in a catch show that they differ significantly from the observed ones (Table 4).

Table 4. Correlation of expected (based on the cubic model of distribution) and observed mean distances between capelin in subgroups.

| Time | Expected, cm | | | Observed, cm | | | Reliability of difference (%) |
|-------|--------------|----------|------|--------------|----------|-----|-------------------------------|
| | R_{av} | σ | n | R_{av} | σ | n | |
| Day | 41.8 | 3.10 | 2091 | 51.6 | 26.9 | 189 | 99 |
| Night | 43.5 | 3.78 | 1856 | 89.4 | 58.5 | 47 | 99 |

If we insert the ratio of the expected and observed values of mean distances between fish in the daytime from Table 4;

$$\frac{51.6}{41.8} = 1.23$$

in equation 4, then the obtained expression

$$R_{av} = 1.23 \rho^{-1/3} \quad (5)$$

will most probably reflect with the maximum degree of approximation the true correlation between R_{av} and absolute density ρ existing in capelin schools.

On density of distribution and orientation of capelin schools

Proceeding from Equation 5, volume densities of capelin subgroups may be determined with the distances between fish marked with the corresponding points a, b, c, d, e and i on the curve of Fig. 5 (Table 5).

Table 5. Density of capelin subgroups and distances between individuals.

| Points on the curve | Ratio of distance and mean body length | Distances in meters | Density in spec./m ³ |
|---------------------|--|---------------------|---------------------------------|
| a | 0.6 | 0.10 | 1862.2 |
| b | 1.5 | 0.23 | 153.0 |
| c | 2.2 | 0.335 | 49.5 |
| d | 3.04 | 0.462 | 18.8 |
| e | 4.2 | 0.639 | 7.12 |
| i | 5.0 | 0.76 | 4.23 |

As is seen from Table 5, the maximum of the observed densities of schools, 15-20 spec./m³ (Fig. 4), corresponds to the distance between fish about 3 body lengths (point d in Fig. 5).

Apparently, when the school becomes compact, spacing between separate subgroups inside it disappears and it becomes a large united school.

Accelerating swimming speeds, for instance, while escaping from predators, the school may condense to such a degree that the distances between fish are reduced to 1.5 body lengths (density 159 spec./m³), thus decreasing viscosity and increasing potential maximum swimming speed.

With a higher density of capelin distribution in the school, when the distances between fish diminish to less than 1.5 body lengths, the swimming conditions sharply deteriorate, and, apparently, the coordinated manoeuvring is hampered. Under natural conditions aggregations of such density are not maintained.

5. CONCLUSIONS

The density of capelin schools is determined by the peculiarities of distance and orientation. In most cases fish inside the school are distributed not regularly, but form small subgroups of 3-5 individuals.

While moving quickly, schools condense and the delineation between subgroups dissipates, thus regulating distribution and average density to about the average density of the subgroup - 18 spec./m³. However, capelin schools with such density and structure are not common and are found in 1-2 % of the total number of observations. In exceptional cases, for instance when attacked by predators, the school compacts to 150 spec./m³. Such a concentration improves conditions of flow-past and, correspondingly, permits fish to achieve maximum swimming speed.

**INVESTIGATIONS ON CAPELIN LARVAE OFF NORTHERN NORWAY
AND IN THE BARENTS SEA IN 1981-84.**

By

Oddgeir Alvheim

Institute of Marine Research,
P.O. Box 1870, N-5011 Bergen, Nordnes
Norway

ABSTRACT

This report gives a detailed description of the sampling technique, employing the Gulf III plankton sampler. The collected data are displayed on distribution maps, which show both the total abundance of capelin larvae and the abundance for each of four length groups. A relative index is given for the number of capelin larvae.

1. METHODS1.1 Sampling with Gulf III plankton sampler

Samples of capelin larvae and plankton were collected with a Gulf III plankton sampler (Zijlstra 1970) in oblique hauls from surface to 60 meters depth and back. Cruising speed during the haul was 5 knots, and the wire speed was 0.5 meters per second. To obtain a maximum depth of 60 meters, approximately 250-260 meters wire were given out, making the duration of the haul about 17 minutes.

In order to check the depth of the Gulf III, a Benthos depth recorder was connected to the sampler in some of the hauls in 1981. In 1982 and 1984 an echo transducer was attached to the tail fin of the Gulf III (Fig. 1). The towing cable transmitted signals from the transducer to a recorder, allowing depth to be traced during the haul. When the sampler reached a depth of 60 meters, it was hoisted. In 1983 a wireless Scanmar depth sensor was connected to the Gulf III, which allowed the depth to be traced continuously onboard the vessel during the haul. Unfortunately a malfunction of the depth sensor made the readings uncertain. The transducer method used in 1982 and 1984 seems to be preferable.

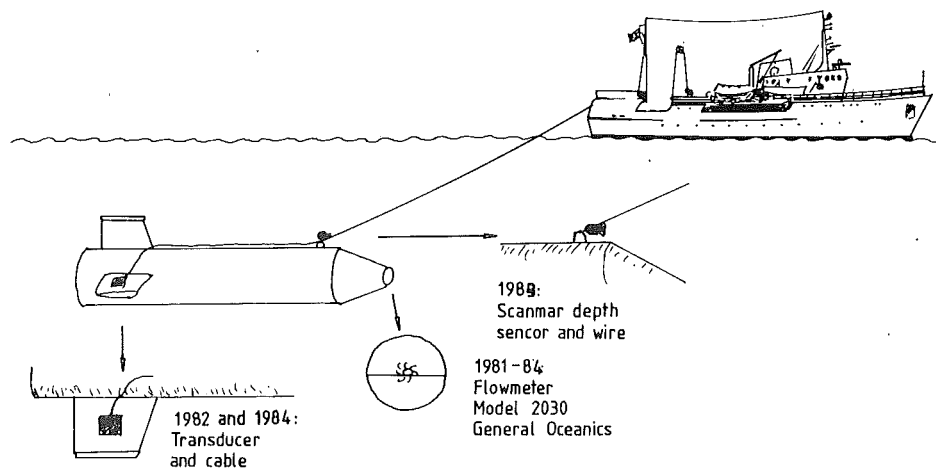


Fig. 1. Arrangement of the transducer (1982 and 1984), the Scanmar depth sensor (1983) and the flowmeter (1981-84).

A flowmeter, Model 2030 General Oceanics, was mounted in the opening of the Gulf III. The number of revolutions per haul was taken as the counter difference before and after hauling.

1.2 Mesh size of the net

The mesh size of the net in the plankton sampler was 273μ , measured as indicated by the arrows in Fig. 2.

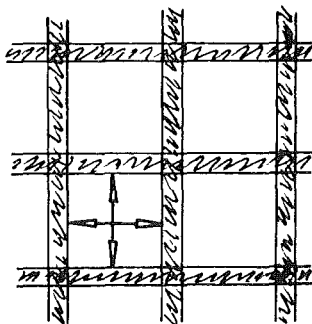


Fig. 2. Measurement of the mesh size in the plankton net.

1.3 Calculation of number of larvae per square meter surface

Number of larvae per square meter surface is calculated by the following formula:

$$N = \frac{n \cdot I}{a \cdot d' \cdot R}$$

N = number of larvae per square meter surface

n = total number of larvae caught

I = depth interval (0-60 meters = 60)

a = area of front opening of Gulf III sampler in square meters

$$(\pi \cdot r^2 = \pi \cdot 0.095^2 = 0.0283529)$$

d' = calibration constant = 0.316 (see next section)

R = number of flowmeter revolutions

Example: Station 59, date 1.6.1983:

$$n = 44$$

$$I = 60$$

$$R = 11634$$

$$N = \frac{n \cdot I}{a \cdot d' \cdot R} = \frac{44 \cdot 60}{0.0283529 \cdot 0.316 \cdot 11634} = 25.3$$

i.e. number per square meter surface = 25.3

1.4 Calibration of the flowmeter

Calibration of the flowmeter can be made either in a tank or in the field. Calibration in tank is done by reading off the counter, towing the flowmeter a known distance and reading the number of revolutions. From the following formula the calibration constant can be calculated:

$$d' = \frac{\text{distance}}{\text{no. of revolutions}}$$

Tank calibrations of the flowmeter used in these investigations gave:
 $d' = 0.316$.

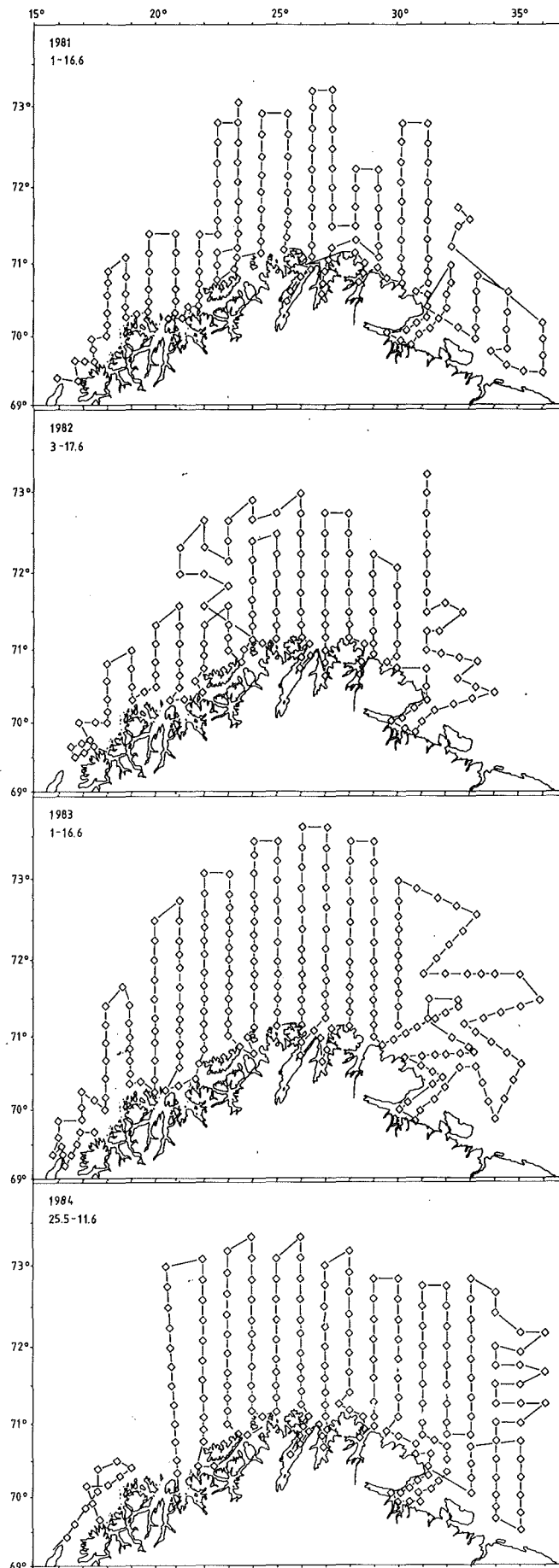
DISTRIBUTION AND MIGRATION
Investigations on capelin larvae in 1981-84

Fig. 3. Cruise tracks and grid of stations for the capelin larval cruises in 1981-84.

Calibration in the field can be accomplished by attaching an additional flowmeter with a known calibration constant to the tailfin of the sampler. Both flowmeters are read before and after the haul, whose distance can be calculated from the calibrated flowmeter reading. Using the formula given above, the calibration constant for the flowmeter in the sampler's mouth may be calculated. To avoid clogging, the plankton net should be removed from the sampler before such a calibration haul. During the capelin larval cruise in 1984 three calibration hauls were carried out. The mean value of the three calibration constants gave a $d'=0.316$.

1.5 Surveying the distribution area

Stations along north-south transects were usually taken at intervals of one degree (Fig. 3). However, the distance between stations in areas with high densities of larvae, (more than 50), was 10 nautical miles. In areas with low densities, the distance between the stations was extended to 15 nautical miles. Stations were also sampled along the coast near known spawning grounds.

1.6 Calculation of number of capelin larvae

The total number of capelin larvae (Fig. 4) and the number of larvae in four different length groups (Figs. 5-8) per square meter surface have been plotted on charts for each year. Then isolines were drawn and, by area integration, the total number of larvae and number of larvae in each length group was found (Table 1).

2. RESULTS

2.1 Total distribution of capelin larvae

Fig. 4 shows the total distribution of capelin larvae observed on the cruises in 1981-84. In 1981 and 1982 the areas of distribution were similar and relatively small, whereas in 1984 the area of distribution was extended to the east by about 60 nautical miles. The most widespread distribution was found in 1983.

The highest concentrations of capelin larvae were usually found near the coastal spawning grounds. The cruise in 1981 gave the highest values in these areas, (more than 1000 larvae per square meter surface), a magnitude occasionally attained in 1982 and 1984. 1983 resulted in a different distribution pattern, with the highest coastal concentrations of capelin larvae less than 500. Conversely, in an area of open sea ($72^{\circ}10'N$, $23^{\circ}E$) one patch of more than 500 capelin larvae per square meter surface was found.

In 1982 and 1984 relatively few capelin larvae were found along the coast in the western part of the investigated area, and few larvae were found in the eastern part during 1981-84. The number of capelin larvae in the Varangerfjord area was extremely low in 1983, mostly below 50 larvae per square meter surface.

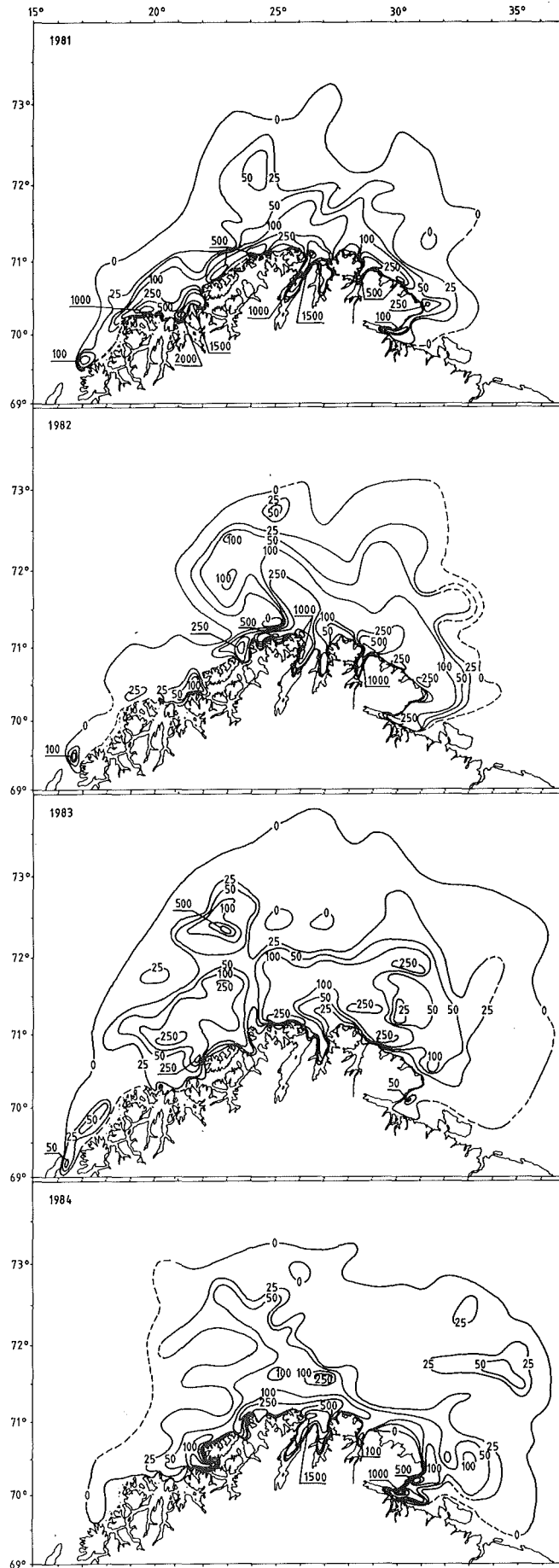
DISTRIBUTION AND MIGRATION
Investigations on capelin larvae in 1981-84

Fig. 4. Total number of capelin larvae per square meter surface in 1981-84.

2.2 Distribution of capelin larvae on length groups

Figs. 5-8 show the distribution of capelin larvae in the length groups 5-9 mm, 10-14 mm, 15-19 mm and >20 mm. typically, the highest concentrations of larvae of 5-9 mm are found near the coast, which thin out until about 100 nautical miles from the coast.

The figures show clearly an increasing area of distribution with increasing length of the larvae. Most of the larvae are transported away from the spawning grounds to the open ocean by the current, but some still remain in coastal waters and fjords.

2.3 Total number of capelin larvae

The number of larvae observed during the cruises 1981-84 is given in Table 1. The total number observed is remarkably constant for this period. Larvae in the two smallest length groups constitute the majority, while the number of larvae >20 mm is very low. The number of larvae per sub-area varies from year to year but was generally low in the eastern section. This corresponds well with the observed spawning areas, as these years only minor spawning took place off Eastern Finnmark.

Table 1. Calculated number of capelin larvae ($\times 10^{-12}$) for the years 1981-84.

| Year | Length in mm | West of 20 E | 20-25 E | 25-28 E | 28-31 E | East of 31 E Varang.f. | Sum |
|------|--------------|--------------|---------|---------|---------|------------------------|------|
| 1981 | 5- 9 | 0.52 | 1.08 | 0.15 | 0.26 | 0.06 | 2.07 |
| | 10-14 | 0.53 | 2.44 | 1.77 | 0.74 | 0.26 | 5.74 |
| | 15-19 | 0.09 | 0.71 | 0.46 | 0.42 | 0.11 | 1.79 |
| | 20 | 0.01 | 0.04 | 0.02 | 0.03 | 0.01 | 0.11 |
| | Total | 1.15 | 4.27 | 2.40 | 1.45 | 0.44 | 9.71 |
| 1982 | 5- 9 | 0.02 | 0.31 | 1.80 | 1.69 | 0.50 | 4.32 |
| | 10-14 | 0.09 | 0.84 | 1.14 | 1.30 | 1.13 | 4.50 |
| | 15-19 | 0.01 | 0.35 | 0.25 | 0.29 | 0.13 | 1.03 |
| | 20 | + | 0.01 | 0.01 | 0.01 | + | 0.03 |
| | Total | 0.12 | 1.51 | 3.20 | 3.29 | 1.76 | 9.88 |
| 1983 | 5- 9 | 0.17 | 0.85 | 0.34 | 0.48 | 0.19 | 2.03 |
| | 10-14 | 0.30 | 1.50 | 0.92 | 1.30 | 0.71 | 4.73 |
| | 15-19 | 0.13 | 0.98 | 0.37 | 0.43 | 0.34 | 2.25 |
| | 20 | 0.02 | 0.43 | 0.16 | 0.14 | 0.18 | 0.93 |
| | Total | 0.62 | 3.76 | 1.79 | 2.35 | 1.42 | 9.94 |
| 1984 | 5- 9 | 0.01 | 0.32 | 1.51 | 0.22 | 0.12 | 2.18 |
| | 10-14 | 0.02 | 0.94 | 1.26 | 0.15 | 1.14 | 3.51 |
| | 15-19 | 0.01 | 0.52 | 0.55 | 0.07 | 0.53 | 1.68 |
| | 20 | 0.02 | 0.39 | 0.18 | 0.04 | 0.15 | 0.78 |
| | Total | 0.06 | 2.17 | 3.50 | 0.48 | 1.94 | 8.15 |

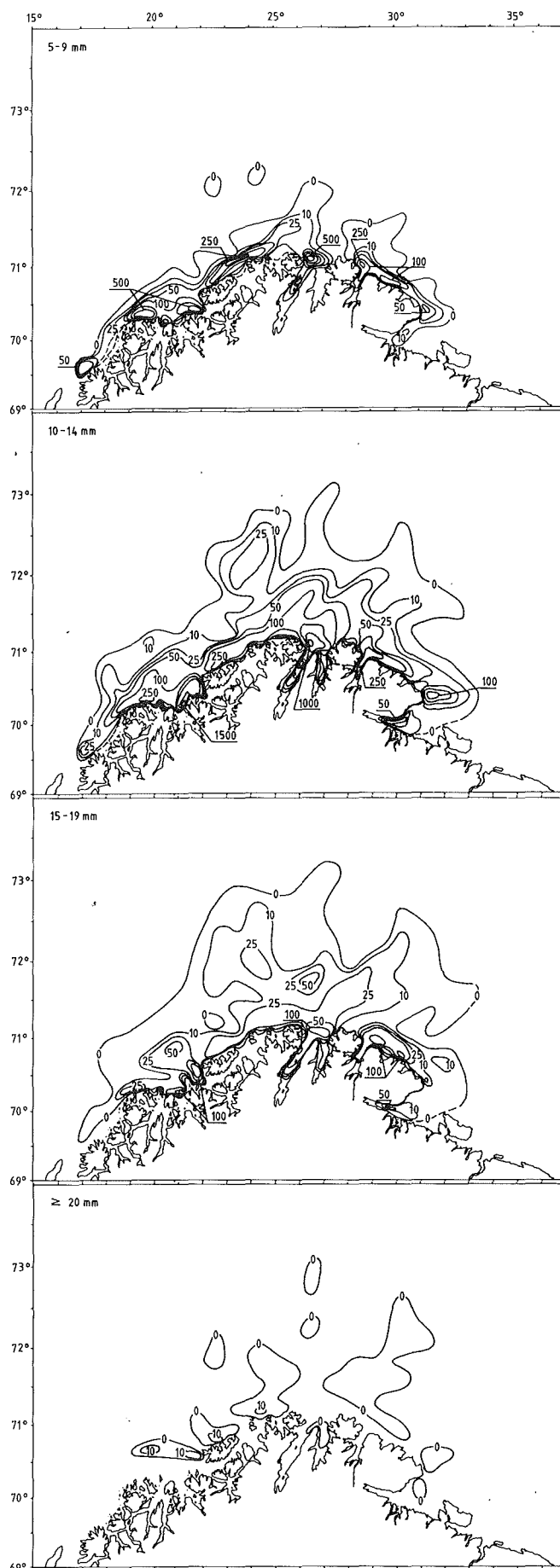
DISTRIBUTION AND MIGRATION
Investigations on capelin larvae in 1981-84

Fig. 5. Number of capelin larvae per square meter surface for different length groups in 1981.

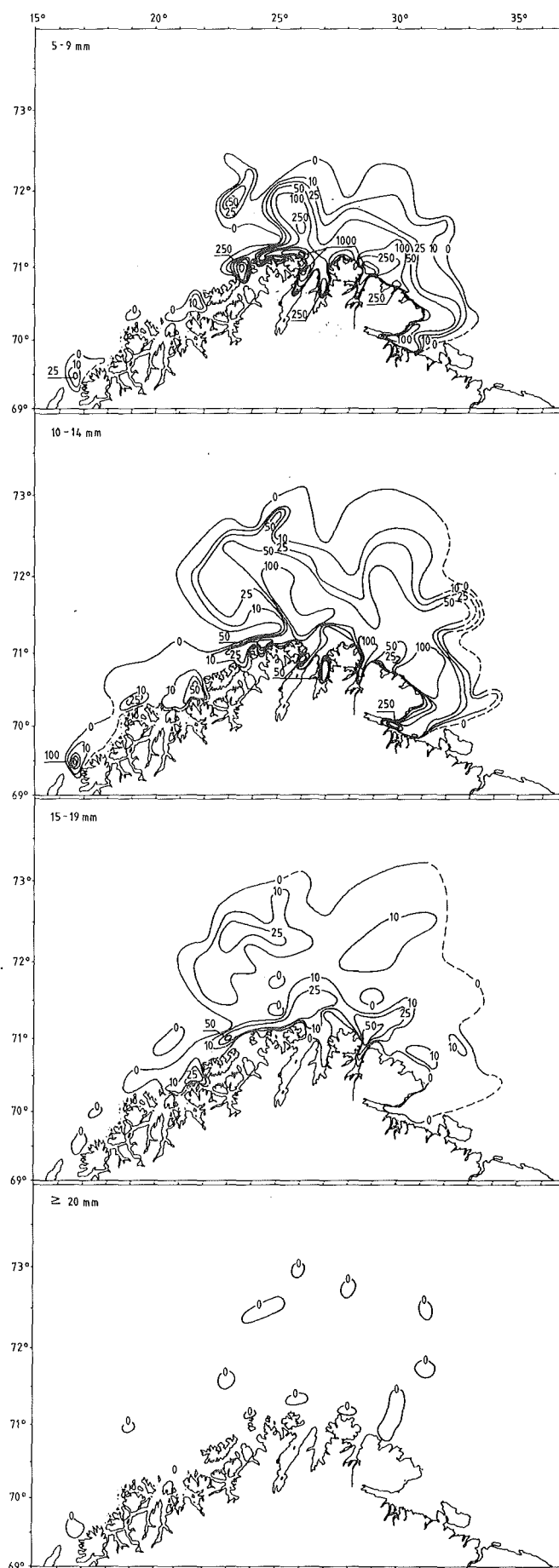


Fig. 6. Number of capelin larvae per square meter surface for different length groups in 1982.

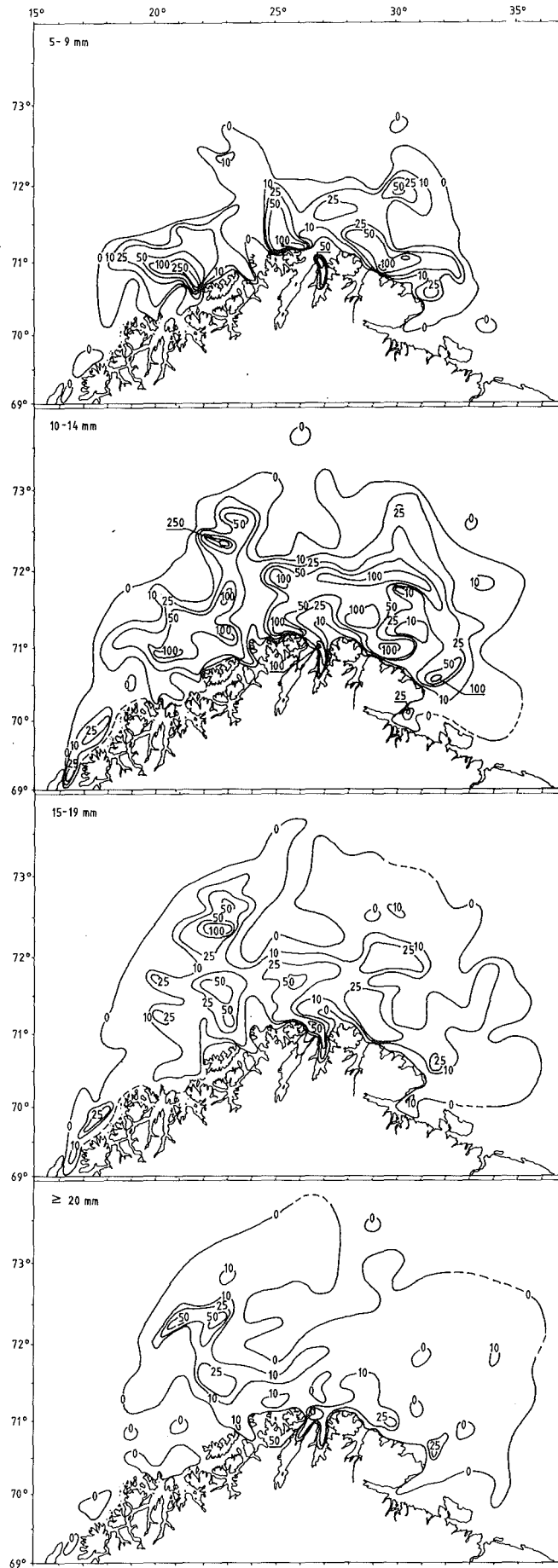
DISTRIBUTION AND MIGRATION
Investigations on capelin larvae in 1981-84

Fig. 7. Number of capelin larvae per square meter surface for different length groups in 1983.

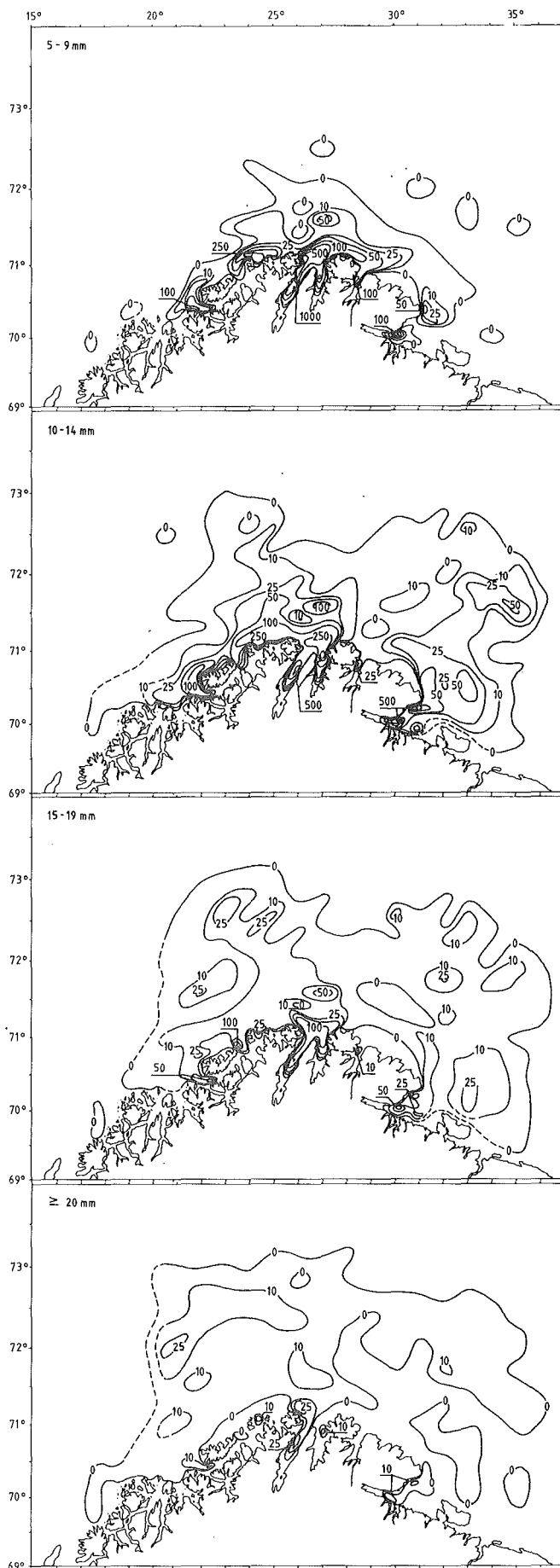


Fig. 8. Number of capelin larvae per square meter surface for different length groups in 1984.

3. DISCUSSION

3.1 Sampling technique

During the period of investigations the sampling technique has remained nearly unchanged from year to year, apart from the systems of reading the sampling depth. These do not affect the haul itself.

If the maximum depth per haul should be increased, correspondingly greater time would be needed for each cruise. Greater accuracy cannot be guaranteed in the results. No thorough investigations have been done so far, but in 1977 a capelin larval cruise was carried out, using Clarke Bumpus Plankton Samplers (CLARKE and BUMPUS 1950). Three CBPS were attached to the wire (Dragesund 1970) to sample at 5-25, 30-50 and 55-75 meters. The catch showed a trend of decreasing numbers with increasing depth (9% of the total in the last depth interval) and supports the practice of hauling only to 60 meters.

3.2 Coverage of the distribution area

To be able to cover the whole distribution area with one vessel within a reasonable short time period, a relatively open sampling grid is necessary. As a consequence of this, the accuracy of the area integration may be low in areas with strong gradients in the larval density. In most years such gradients may be found close to the coast, primarily affecting the smallest length group. An assessment of the resulting effect on the calculated larval index has not been attempted, but one may speculate that in some cases the effect could be substantial.

3.3 Time of spawning - time of larval cruise

The main spawning period for the Barents Sea capelin is March-April, while minor spawning takes place from the end of February until the summer. A dense concentration of spawning capelin was found in end of February 1984 along the coast of Troms (70° 20' N, 18° E) (TORESEN 1984). One month later a dense concentration of newly hatched capelin larvae was found in the same area (DOMMASNES, A., pers. comm.), but that year's larval cruise found very few larvae in this area. A mass mortality may have occurred to these larvae, but most likely they were transported to the north-east by the current. The patch of larvae at position 72° N, 20° E seen in the lower map on Fig. 8 probably came from this spawning area. This illustrates the difficulties of obtaining a detailed picture of the early life of capelin larvae, based on only one cruise a year.

The larvae experience a high and probably unpredictable mortality at the earliest life stages. Consequently the larval index is not only dependent on number of larvae hatched, but also on the time lag between hatching and larval cruise covering. The long spawning period adds to this source of variance.

It seems though that the larval cruise in June is carried out well after the main hatching, and probably after the period of most intense larval mortality. Consequently the larval abundance index can be regarded as a tentative index of year class strength. While too rough for a forecast of spawning stock biomass two or three years ahead, it may give information on major changes taking place in the success of spawning, hatching and survival through the earliest life stages of the capelin.

4. REFERENCES

- CLARKE, A. L. and BUMPUS, D. F. 1950. The plankton sampler - an instrument for quantitative plankton investigations. Spec.Publs Am.Soc.Limnol.Oceanogr., 5:1-8.
- DRAGESUND, O. 1970. Factors influencing year-class strength of Norwegian spring spawning herring (Clupea harengus L.). Fisk Dir.Skr.Ser.HavUndres., 15:381-450.
- TORESEN, R. 1984. To hovedinnsig av lodde vinteren-84. Fiskets Gang, 70:365. (In Norwegian)
- ZIJLSTRA, J. J. 1970. Herring larvae in the central North Sea. North Sea.Ber.Dt.Wiss.Komm.Meeresforsch., 21:92-115.

**THE DISTRIBUTION OF CAPELIN LARVAE IN THE NORWEGIAN AND BARENTS SEAS
IN APRIL-MAY 1968-1983.**

by

Serebryakov V.P.^{*}, Aldonov V.K.^{*}, Astaf'eva A.V.^{*} and Mukhina N.V.^{**}

* All-Union Research Institute of Marine Fisheries and Oceanography
/VNIRO/, Moscow, USSR.

** Polar Research Institute of Marine Fisheries and Oceanography
/PINRO/, Murmansk, USSR.

ABSTRACT

Maps of the distribution pattern of capelin larvae are constructed on the basis of material obtained during ichthyoplanktonic surveys in the northeast part of the Norwegian sea and in the southwest part of the Barents Sea in April-May in 1968-1983. The distribution area of capelin larvae in the Barents and Norwegian Seas was much larger in 1968, 1969, 1971, 1972, 1980, 1981 and 1983 than in other years. A total of three types of distribution of capelin larvae are observed:

Type I -larvae are widely distributed along the coast, the heaviest densities being observed on the Fugløy, Malang and Finnmarken Banks and in the Norwegian Trench.

Type II -larvae are distributed over a small area only in the east part of the area surveyed.

Type III -larvae are distributed only over the Norwegian Trench area and on the Finnmarken Bank. The comparison of the types with the abundance of yearclasses of capelin has indicated no correlation between the parameters.

1. INTRODUCTION

The problem of how capelin (Mallotus villosus villosus Müller) approach the costal area for spawning is frequently discussed in literature. Most researchers believe that more eastern or western approaches of capelin are associated with the thermal conditions in the Barents Sea, e.g. the spawning area shifts, as a rule, westward in hydrologically cool years and shifts eastward and northeastward in warm years (Rass 1933; Zatsepin, Petrova 1939; Marty 1939; Grinkevish 1957; Prokhorov 1957, 1963, 1965; Nizovtsev, Prokhorov 1962 and others).

Glebov (1952, 1963) believes that the approach of capelin depends on the thermal regime in the south parts of the Barents Sea in the winter-autumn period. In cool years capelin move to the Norwegian coast and West Murman, in temperate years they are widely distributed over the entire Murmansk coastal area and in warm years their spawning grounds shift to the southeast part of the Barents Sea. Recent investigations (Prokhorov 1963, 1965; Konstantinov 1967; Bochkov 1969; Penin 1973; Shevchenko, Galkin 1983) make it possible to distinguish several forecasting criteria for determining a locality and numerical strength of spawners with some degree of confidence.

Information on the presence of capelin larvae has been printed in Soviet literature more or less regularly since the 1930's (Suvorov et al. 1931; Rass 1933; Pertseva 1939). With the increasing significance of capelin in the fisheries and with the broadening scale of their usage (at first as bait in the fishery for other species and later as a food product) the investigations have intensified. Several papers are dedicated to the description of development of capelin in early ontogenesis and to the distribution of their larvae and juvenils (Khokhlina 1957; Baranenkova 1961; Baranenkova, Khokhlina 1961; Kashkina 1962; Pozdnyakov 1962; Prokhorov 1965). Data on the distribution of capelin larvae are also published in foreign literature (Wiborg, 1950, 1952, 1954, 1961, 1962).

Regular observations on the abundance of eggs and larvae of commercial species of fish on route from their spawning grounds in the Barents and Norwegian Seas have been conducted by the Polar Research Institute since 1959, (see Baranenkova et al.). However there are no papers with the exception of Baranenkova's and Khokhlina's (1970) in literature which would discuss the distribution of capelin larvae on a long term basis.

The present paper suggests an analysis of the distribution of larvae of capelin in the Barents and Norwegian Seas in April-May on the basis of the results obtained in the ichthyoplanktonic surveys made in 1968-1983.

2. MATERIALS AND METHODS

The ichthyoplanktonic surveys were conducted annually by reserch vessels of PINRO in the northeast part of the Norwegian Sea and in the southwest part of the Barents Sea.

A total of 2978 stations were sampled and a total of 8934 samples of ichthyoplankton were collected and treated.

The distribution of capelin larvae in April-May 1968-1983

A total of 138461 capelin larvae were found in samples, of them 134285 were found in collections from horizontal hauls and 4176 in samples from vertical hauls, (Table 1). Larvae were 6,0-41,0 mm long.

Table 1 The number of larvae in samples collected at standard stations in April-May 1968-1983.

| Year | Total number of stations | Number of larvae in horizontal hauls | | Number of larvae vertical hauls | Total |
|------|--------------------------|--------------------------------------|-----------------|---------------------------------|-------|
| | | near surface | in 25-0 m layer | | |
| 1968 | 191 | 2651 | 3232 | 560 | 6443 |
| 1969 | 183 | 1021 | 62839 | 553 | 64413 |
| 1970 | 197 | 7 | 598 | 44 | 649 |
| 1971 | 143 | 4478 | 5655 | 91 | 10224 |
| 1972 | 206 | 524 | 12241 | 332 | 13097 |
| 1973 | 193 | 19 | 567 | 108 | 694 |
| 1974 | 200 | 1314 | 3632 | 99 | 5045 |
| 1975 | 214 | 6 | 965 | 131 | 1102 |
| 1976 | 212 | 346 | 4277 | 168 | 4791 |
| 1977 | 189 | 2 | 24 | 8 | 34 |
| 1978 | 219 | 5 | 3 | 0 | 8 |
| 1979 | 159 | 29 | 1126 | 1 | 1156 |
| 1980 | 174 | 1376 | 4437 | 207 | 6020 |
| 1981 | 182 | 271 | 10239 | 557 | 11067 |
| 1982 | 165 | 345 | 4819 | 362 | 5526 |
| 1983 | 151 | 1735 | 5502 | 955 | 8192 |

The maps of distribution of capelin larvae are made by a computer with a graph plotter. Maps drawn on the data collected in vertical hauls were compared with those plotted on samples from horizontal hauls. It is found that areas of greatest density in 1968 and 1974 as a rule, coincide. Therefore in order to define boundaries of the distribution of larvae and areas where they are heavily concentrated the sum of data obtained from two horizontal hauls (one near the surface, the other in the 25-0 m layer) is used. The abundance of larvae is assessed by the results of vertical hauls.

The principal spawning grounds were defined by the distribution of pre-larvae (6.0-7.0 mm long) since larger larvae may drift long distances with currents. Material on the sizes of larvae and their absolute abundance in the area surveyed is not treated here.

The abundance of capelin at the age of 2+ is used as a criterium of the abundance of yearclasses (Serebryakov, 1984). A yearclass will be classified as rich if the abundance of specimens at the age of 2+ is more than 3.5×10^{11} specimens, moderate if the 2+ year-olds constitute $2.5-3.5 \times 10^{11}$ and the yearclass will be poor if the abundance of two-year-olds is less than 2.5×10^{11} .

3. RESULTS

The largest number of larvae collected is 64 413 in 1969, the smallest number is 8 in 1978 (Table 1).

One may distinguish three repeating situations in the distribution of areas with heaviest concentrations of capelin larvae (Fig. 1):

- I. Larvae are widely distributed along the coast and the heaviest concentrations occur mostly on Malang, Fugløy, Finnmarken Banks and in the Norwegian Trench area (1968, 1969, 1971, 1972, 1980, 1981, and 1983);
- II. Larvae occur only in the east part of the area surveyed and only over a small area (1973-1977);
- III. Larvae are recorded only at the northern extremity of the Scandinavian Peninsula, in the Norwegian Trench area and on the Finnmarken Bank (1970, 1979, and 1982).

Under situation I, there are two areas with the heaviest concentration of larvae. So in 1968, 1971, 1972 and 1983 most larvae were collected in two areas: on the Malang and Fugløy Banks and in the Norwegian Trench and Finnmarken Bank. The distribution of larvae in 1978 cannot be categorized under any of the situations, because only a few larvae were collected on the Røst bank and on the east slope of the Bear Bank.

The comparison of the types of distribution patterns in capelin larvae with the abundance of yearclasses indicates no relationship between the abundance of larvae and characteristics of the distribution of larvae. Abundant yearclasses appear both under Type I of distribution of larvae (1972) and under Type II (1976). Moderate yearclasses occur under Type I (1980) and Type II (1973, 1977). Poor yearclasses emerge under all three types of distribution, e.g. under Type I (1981), under Type II (1974, 1975) and under Type III (1979). Thus, the distribution pattern of larvae fail to serve in predicting the abundance of yearclasses of capelin.

4. REFERENCES

- Aldonov V.K. and Serebryakov V.P. 1983. The abundance of the Arcto-Norwegian cod north of Lofoten. Presented to the Soviet-Norwegian symposium on Reproduction and Recruitment of Arctic Cod. Leningrad, Sept. 26-30 1983, p.1-31.
- Baranenkova A.S. 1961. To the methods of investigations of early stages of development in commercial species of fish. Nauch.Bull. PINRO, Murmansk No.2-3 (16-17), p.10-13.
- Baranenkova A.S. 1974. Long-term fluctuations in the abundance of eggs and larvae of fish from the Barents Sea. Sb. Materialy rybokhoz. issled. Severnogo basseina. Murmansk, issue 21, p.93-100.
- Baranenkova A.S. Zhuravleva V.K., Khokhlina N.S. 1970. The distribution and drift of larvae of commercial species of fish from the Barents Sea in June-July 1967. Sb. Materialy rybokhoz. issled. Servenogo basseina. Murmansk, issue 14, p.26-43.

The distribution of capelin larvae in April-May 1968-1983

- Baranenкова A.S. Lutsenko G.B. Khokhlina N.S. 1982. The distribution and abundance of eggs and larvae of commercial species of fish from the Barents Sea in April-July 1971-1973. Sb. Ekologiya i promysel donnykh ryb Severo-Evropejskogo basseina, Murmansk, p.4-7.
- Baranenкова A.S. Sorokina G.B. Khokhlina N.S. 1976. The distribution and abundance of eggs and larvae of principal commercial species of fish from the Barents Sea in 1970. Trudy PINRO, issue 3, p.91-128.
- Baranenкова A.S. Khokhlina N.S. 1961. The distribution of larvae of commercial species of fish from the Barents Sea in 1959-1960. Nauch. -Tekh. bull. PINRO No.2-3 (16-17), p.14-18.
- Baranenкова A.S. Khokhlina N.S. 1970. The distribution and length of larvae and fry of capelin Mallotus villosus from the Barents Sea. Sb. Materialy rybokhoz. issled. Severnogo basseina, issue 16, part 1, p.118-131.
- Bochkov Ju.A. 1969. On the influence of the thermal conditions on the distribution and abundance of yearclasses of capelin spawning in spring. Trudy PINRO, issue 25, p.205-218.
- Glebov T.I. 1952. The family Osmeridae. Sb. Promysl. ryby Barentseva i Belogo morei. Leningrad, Pishchepromizdat, p.92-98.
- Glebov T.I. 1963. Cod from the Murmansk coast. Trudy PINRO, issue 15, p.69-130.
- Grinkevich N.S. 1957. Annual changes in the feeding habits of cod from the Barents Sea. Trudy PINRO, issue 10, p.98-105.
- Kashkina A.A. 1962. Ichthyoplankton of the southeast part of the Barents Sea. Murmanskogo morskogo inst. issue 4/8, p.97-133.
- Khokhlina N.S. 1957. The distribution and movement of the Barents Sea capelin in 1945-1952. Trudy PINRO, issue 10, p.212-229.
- Konstantinov K.C. 1967. Use of data on water temperature for short-term prediction of trawl catches in the Barents Sea. Trudy PINRO Murman. morsk. biol. inst. issue 15/19, p.54-58.
- Marty Yu.Yu. 1939. Material to the biology of Murmansk coast cod. Trudy PINRO, issue 3, p.3-38.
- Nizovtsev, C.B. Prokhorov V.S. 1962. The spawning of capelin. Nauch. Tekh. bull. PINRO, No. 4/22, p.22-23.
- Penin V.V. 1973. Use of hydrometeorological factors in the assessment of the approach pattern of capelin to the south coast of the Barents Sea. Trudy PINRO, issue 34, p.82-93.
- Pertseva T.A. 1939. Spawning, eggs and fry of fish in the Motovskij Bay. Trudy VNIRO, vol.IV, p.417-470.
- Pozdnyakov Ju.F. 1960. Material on the development of capelin from the Barents Sea. Trudy Murmanskogo Morsk. biol. inst. issue 2/6, p.211-225.

- Pozdnyakov Ju.F. 1962. The distribution of capelin larvae in the south and southeast parts of the Barents Sea. Trudy Murmanskogo Morsk. biol. inst. issue 4/8, p.134-145.
- Prokhorov, V.S. 1957. On migration and spawning of Barents sea capelin in 1953-1954. Trudy PINRO, issue 10, p.230-243.
- Prokhorov, V.S. 1963. Some ecological characteristics of capelin Mallotus villosus (Müller) from the Barents Sea. Trudy PINRO, issue 15, p.163-176.
- Prokhorov, V.S. 1965. Ecology of the Barents Sea capelin and prospect for their fishery. Trudy PINRO, issue 19, p.1-68.
- Rass T.S. 1933. Spawning of the capelin Mallotus villosus from the Barents Sea. Trudy GOIN vol. 4, issue 1, p.3-28.
- Shevchenko A.V. Galkin A.S. 1983. On forecasting dates of the approach of Barents Sea capelin to the Murman coast for spawning. Biologiya i promysel pelagicheskikh ryb Severnogo basseina. Murmansk, p.31-36.
- Suvorov, E.K. Vadova L.V. Synkov A.I. 1931. Biology of capelin. Trudy Leningr. nauch. issled. ikhtiolog. inst. vol 2, p.51-104.
- Wiborg K.F. 1950. Utbredelse og forekomst av fiske-egg og fisk-ungel på kystbankene i Nordnorge våren 1949. Fiskeridirektoratets småskrifter No. 1.
- Wiborg K.F. 1952. Forekomst av egg og yngel av fisk i nordnorske kyst og bankfarvann våren 1950-1951. Fiskets Gang No.4.
- Wiborg K.F. 1954. Forekomst av fiskeegg og yngel i nordnorske farvann våren 1952 og 1953. Fiskets Gang Nr.1.
- Wiborg K.F. 1960. Forekomst av egg og yngel av fisk i vest og nordnorske kyst og bankfarvann våren 1959. Fiskets Gang No.37.
- Wiborg K.F. 1961. Forekomst av egg og yngel av fisk i vest og nordnorske kyst og bankfarvann våren 1960. Fiskets Gang No.9.
- Wiborg K.F. 1962. Forekomst av egg og yngel av fisk i vest og nordnorske kyst og bankfarvann våren 1961. Fiskets Gang No.11.
- Zatsepin V.I. Petrova N.S. 1939. The feeding habits of commercial schools of cod in the south part of the Barents Sea. Trudy PINRO, issue 5, p.3-170.

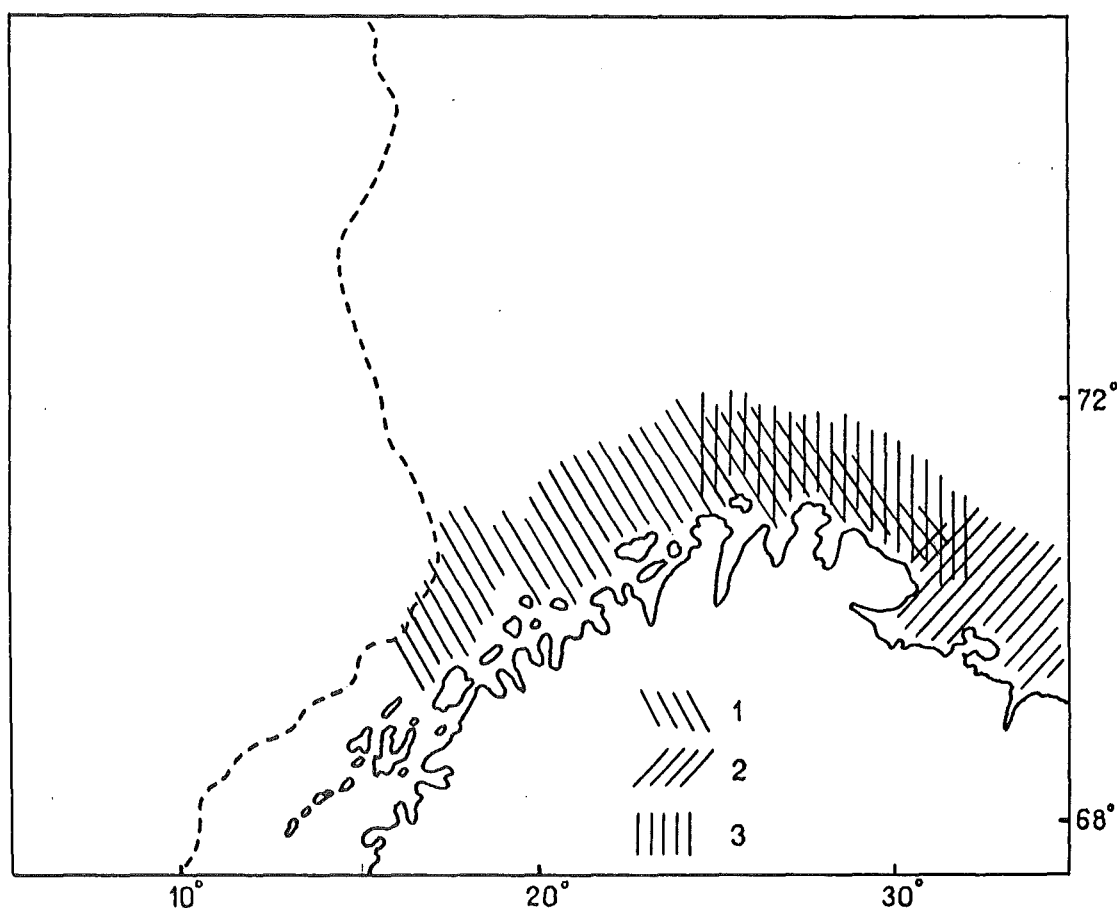


Fig.1. Three types of distribution in capelin larvae. Key to symbols:

- 1 -Type 1 of distribution of larvae.
- 2 -Type 2 of distribution of larvae.
- 3 -Type 3 of distribution of larvae.

DISTRIBUTION AND MIGRATION
The distribution of capelin larvae in April-May 1968-1983

GROWTH OF THE BARENTS SEA CAPELIN OF THE YEARCLASSES 1975-1981

By

Harald Gjøsæter

Institute of Marine Research,
P.O. Box 1870,
N-5011 Bergen, Nordnes
Norway

ABSTRACT

The method of backcalculating fish lengths based on yearly growth markings in the otoliths is applied to estimate growth of capelin in the yearclasses 1975 to 1981. The Barents Sea is divided into five subareas, and the growth estimates are discussed, in relation to the level of yearclass, year, subarea and sex.

1. INTRODUCTION

Growth differences have been documented for the Barents Sea capelin stock, both within and between yearclasses. Differences between yearclasses were discussed e.g. by Monstad and Gjøsæter (1977), and variation in the mean lengths and weights of age-groups sampled in different subareas has been discovered during the joint Soviet/Norwegian autumn surveys to assess the distribution and abundance of this capelin stock.

Growth variation is essential to management of all fish populations, and particularly so with the capelin stocks. The number of individuals in the Barents Sea capelin stock is very high, and consequently even small individual losses or gains in weight may have a significant effect on the total biomass. In addition, the population dynamic seems to be closely linked to growth through length-dependent maturity and high spawning mortality.

This paper aims at a description of growth and growth variation as observed between yearclasses, years, geographical subareas and sex in the period 1975 to 1983.

2. MATERIALS

The investigation is based on data on capelin collected during the annual joint Soviet/Norwegian cruise to assess the abundance of the Barents Sea capelin stock in September. Data from 1975 to 1983 are included. Details on sampling procedures and measurements recorded are given in Gjøsæter (1984). Only the age-groups two years and older are used for backcalculation of lengths. The Barents Sea is divided into eight subareas, (Fig. 1), but only four or five of these are usually inhabited by the capelin in September. The data are classified according to which subarea the samples were taken from and are weighed by the acoustic abundance estimates for these subareas according to the method outlined by Gjøsæter (1984)

3. METHODS

To describe the mean individual growth of capelin in yearclasses and subareas, fish lengths were backcalculated based on otolith zone radii. By using this indirect method to study growth, some problems with growth studies based on length-at-age observations are partly avoided; as illustrated in the following paragraphs.

The sampling gear selection on small fish will have no effect on the growth estimates, since the size of the youngest age-groups is estimated from otoliths from older fish.

The effects of a possible size selective mortality can be studied by comparing length estimates based on fish from the same yearclass caught at different ages.

The problems induced by differences in when the growing season ends, between years and subareas, are overcome by referring to growth between periods of slow growth represented by the hyaline zones in the otoliths.

Growth of the barents sea capelin of the yearclasses 1975-1981

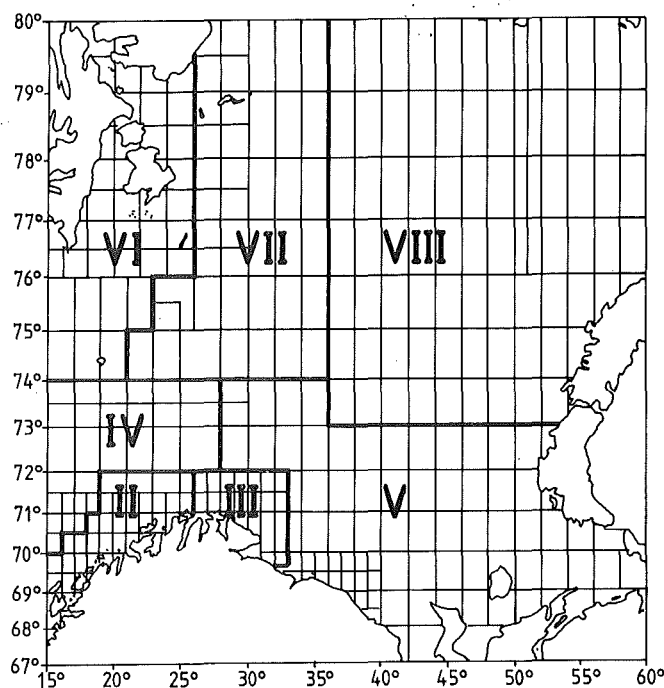


Figure 1. Map covering the Barents Sea showing the subareas (Roman numerals) referred to in the text.

The method of backcalculation of fish lengths from growth markings in scales, otoliths or other hard skeletal parts was introduced by Lea (1910) and has been widely used since then. The method, based on otoliths, can be outlined as follows, when fish length is called L and otolith radius is called R :

If the relationship between fish growth and otolith growth can, to a certain degree of accuracy, be described by a mathematical function, and there exists cyclical growth markings in the otoliths with a known period, then a certain increment in R between these growth markings is associated with a certain increment in L over the time interval delimited by the growth markings.

The relationship between fish growth and otolith growth, is of course, unknown for individual fishes. However, if a strong relationship is found between R and L over certain intervals, this function should be a good approximation of the relationship to individuals over the same intervals.

To avoid possible seasonal variation in the R/L -relationship introducing noise in the sought relation, only fish caught in the same season every year (September/October) were included in the analysis of the relationship. The data were initially divided into yearclass, age-group, sex (males, females and juveniles) and area (east and west of 25° E). Plots of R/L -relationships were made for each of the groups, and for different combinations within each yearclass. The distributions could not be compared using standard mathematical techniques, as each group contained different intervals of R and L , and there was also a clear increase in variance with increasing values of the variates. The two areas were pooled, as no systematic difference could be found by inspection of the plots. Correlation coefficients, (r) , were then calculated for the males, females and juveniles separately, and for the pooled data within each yearclass (Table 1).

The values of r indicate strong linear relationships between R and L for all studied groups. Very little difference can be traced visually between the slopes of the R/L -relationships for the juveniles, males and females. The high linear correlation for the pooled data compared to the separate groups also indicates that the groups may be pooled within yearclass and the R/L -relationship described by a single straight line. It is then reasonable to infer that the same kind of relationship is appropriate for describing the R/L -relation in each individual fish during its growth history. Although inspection of newly hatched larvae reveals that the otoliths do not grow according to this relationship during the earliest growth stages, this linear phase is in effect before the first winterring is deposited, and so will not affect the backcalculation.

The line which best describes the R/L -relationship for individual fishes in the R -interval used for backcalculation, is the straight line through its measured R/L -point at capture and the theoretical fish length at zero otolith radius, which may be considered equal for all individuals within a yearclass. This point must however, be estimated by extrapolation from the data of the linear phase of the relationship. Despite the many models proposed for describing linear relationships between variates whose values have been determined by probability distributions, there is little concensus as to which model should be used in each particular case. The most straightforward method, and perhaps the only one applicable when extrapolation outside the limits of the studied distribution is necessary, is to draw a "line of best fit" by hand. This method was applied in this study, and lines were drawn running through the mean of the bivariate distributions. The estimated intercepts varies from 14 to 21 mm for the seven yearclasses (Table 1).

An example of the R/L -plots is shown in Fig. 2. The following equation is then used for the backcalculation:

$$L_n = a + \frac{L_c - a}{R_c} \cdot R_n \quad (1)$$

where L_n is estimated length corresponding to measured otolith radius R_n ofⁿ winterring no. n , L_c and R_c are the fish length and otolith radius measured at capture, and a is the intercept of the L -axis for $R=0$, estimated by the straight line drawn through the distribution.

TABLE 1. RESULTS OF ANALYSIS OF R/L-RELATIONSHIPS

\bar{L} and \bar{R} are the mean length and mean otolith radius, estimated from data collected in September for the yearclasses 1975-1981. r is the correlation coefficient and n the number of pairs of variates.

| YEARCL. | GROUP | \bar{L} | \bar{R} | r | n | ESTIMATED |
|---------|-----------|-----------|-----------|-----|------|-----------|
| | | mm | mm | | | INTERCEPT |
| | | | | | | mm |
| 1975 | juveniles | 102.3 | .58 | .94 | 2447 | |
| | females | 134.0 | .79 | .79 | 1229 | |
| | males | 136.8 | .80 | .84 | 1162 | |
| | SUM | 118.7 | .68 | .94 | 4838 | 21 |
| 1976 | juveniles | 97.3 | .55 | .93 | 3049 | |
| | females | 133.9 | .79 | .70 | 800 | |
| | males | 136.1 | .80 | .80 | 813 | |
| | SUM | 110.3 | .64 | .95 | 4662 | 19 |
| 1977 | juveniles | 103.0 | .59 | .96 | 970 | |
| | females | 144.1 | .87 | .80 | 1664 | |
| | males | 148.3 | .88 | .85 | 1687 | |
| | SUM | 136.5 | .81 | .94 | 4321 | 14 |
| 1978 | juveniles | 127.3 | .76 | .98 | 583 | |
| | females | 135.1 | .80 | .88 | 1175 | |
| | males | 137.1 | .82 | .88 | 1643 | |
| | SUM | 134.8 | .80 | .93 | 3901 | 19 |
| 1979 | juveniles | 121.0 | .71 | .96 | 1324 | |
| | females | 128.0 | .76 | .89 | 3148 | |
| | males | 129.3 | .77 | .90 | 3170 | |
| | SUM | 127.3 | .76 | .92 | 7642 | 16 |
| 1980 | juveniles | 82.3 | .45 | .96 | 993 | |
| | females | 125.3 | .74 | .89 | 1919 | |
| | males | 126.2 | .74 | .91 | 2266 | |
| | SUM | 118.0 | .69 | .96 | 5178 | 17 |
| 1981 | juveniles | 81.1 | .43 | .94 | 1024 | |
| | females | 124.5 | .75 | .86 | 1422 | |
| | males | 125.3 | .75 | .89 | 1832 | |
| | SUM | 114.4 | .67 | .95 | 4278 | 21 |

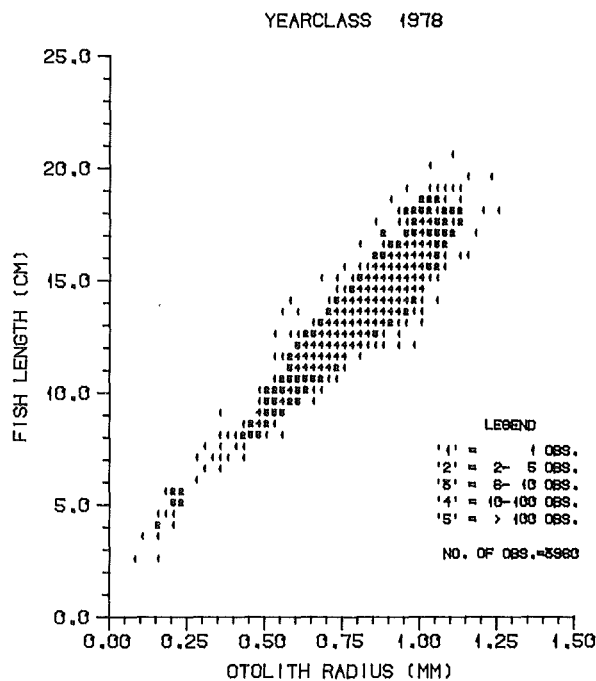


Figure 2. L/R-distribution for the yearclass 1978.

Growth of the barents sea capelin of the yearclasses 1975-1981

Earlier work on backcalculating lengths of capelin has been conducted on data from the Newfoundland area (Tempelmann 1968) and the Barents Sea (Prokhorov 1965, Monstad and Gjøsaeter 1977).

Tempelmann (1968) found an R/L-relationship in the form of two straight lines, and backcalculated along these lines. He did not separate sexes or areas when establishing the relationship.

Prokhorov (1965) arrived at similar curves for the Barents Sea capelin.

Monstad and Gjøsaeter (1977) pooled data from various subareas in the Barents Sea, from different seasons and yearclasses. They separated the sexes but found no difference in the R/L-relationship. The two straight lines derived from regressions corresponded to two segments on the R-distribution, namely R less and greater than 0.74 mm. This value was chosen because the R/L-distribution became steeper while the variance became greater above this point. Their R/L-distribution is almost identical to the ones derived in the present paper for the younger fish, but a bit steeper for the oldest. However, the deviations are rather small, so a rough comparison may be made between the backcalculated lengths and the lengths derived from the present data. For backcalculation they used average radius-measurements and calculated only mean lengths.

4. RESULTS

4.1 Growth of the yearclasses 1975 to 1981, total stock

Backcalculated lengths based on age-groups two to five are shown in Fig. 3 to 8, represented by the distribution mean. Before 1980, sex determination was carried out on individuals more than 12 cm long only. Consequently the length distribution for the two year olds are heavily biased towards greater lengths when separated by sex. For the yearclasses 1975 to 1977 only growth curves based on all fish combined are given (Fig. 3 to 5).

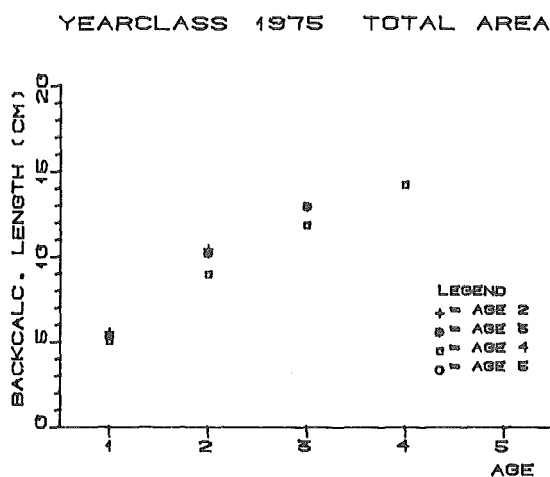


Figure 3. Backcalculated lengths for the 1975 yearclass.

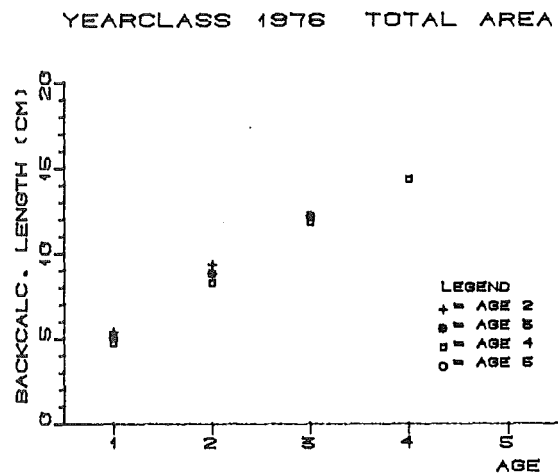


Figure 4. Backcalculated lengths for the 1976 yearclass.

Growth of the barents sea capelin of the yearclasses 1975-1981

Data based on less than 10 individuals are not shown on the plots. The number of fishes in each age-group each year is shown in table 2. Corresponding analyses were not conducted for each subarea separately, as the different parts of the stock do probably not stay in the same area throughout all life stages.

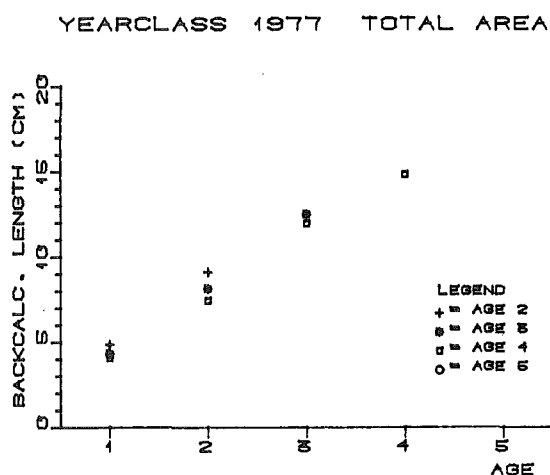


Figure 5. Backcalculated lengths for the 1977 yearclass.

The tables 3, 4 and 5 reveals the magnitude of the growth differences between sexes and yearclasses. The standard deviation given for the backcalculated length distributions is a product of the variation in the underlying R-distributions and the additional variation which may be introduced by the backcalculation.

4.2 Length differences between sexes

At L_1 , there is no great differences between the sexes. When 2-year-olds are measured, the females are an average of 0.4 mm longer than the males. Measured at three- and four years old, the males are an average of 0.7 and 2.8 mm longer than the females (Table 3).

At the time of deposition of the second winterring, the length difference is 0.4 mm in favour of the males when measured at two years old, and the males are 2.3 and 6.5 mm longer as measured in three- and four-year-olds (Table 4).

When the third ring is deposited, the males are longer than the females measured both at three- and four-year-olds, by 4.4 and 7.1 mm respectively (Table 5).

Based on these results, two important observations may be made. Firstly there is a gradual decrease in both L_1 , L_2 and L_3 with increasing age. This is generally known as "Lee's phenomenon", and will be discussed later. Secondly, this phenomenon is seen to be more pronounced for the females than for the males.

TABLE 2 NUMBER OF FISHES SAMPLED

| YEAR | AGE | SUBAREAS | | | | | | TOTAL AREA |
|------|-----|----------|-----|-----|-----|------|------|------------|
| | | III | IV | V | VI | VII | VIII | |
| 1977 | 2 | 0 | 0 | 25 | 74 | 696 | 1571 | 2366 |
| | 3 | 0 | 0 | 0 | 30 | 304 | 907 | 1241 |
| | 4 | 0 | 0 | 0 | 12 | 86 | 353 | 451 |
| | 5 | 0 | 0 | 0 | 1 | 15 | 62 | 78 |
| 1978 | 2 | 0 | 82 | 79 | 281 | 1012 | 1092 | 2546 |
| | 3 | 0 | 2 | 0 | 52 | 177 | 287 | 518 |
| | 4 | 0 | 0 | 0 | 4 | 15 | 38 | 57 |
| | 5 | 0 | 0 | 0 | 1 | 4 | 4 | 9 |
| 1979 | 2 | 0 | 0 | 54 | 0 | 511 | 660 | 1225 |
| | 3 | 0 | 0 | 66 | 0 | 221 | 363 | 650 |
| | 4 | 0 | 0 | 2 | 0 | 11 | 13 | 26 |
| | 5 | 0 | 0 | 0 | 0 | 0 | 0 | 0 |
| 1980 | 2 | 0 | 0 | 175 | 144 | 1051 | 1111 | 2481 |
| | 3 | 0 | 0 | 156 | 128 | 726 | 1376 | 2386 |
| | 4 | 0 | 0 | 29 | 12 | 168 | 244 | 453 |
| | 5 | 0 | 0 | 1 | 0 | 1 | 4 | 4 |
| 1981 | 2 | 0 | 0 | 150 | 159 | 2531 | 1829 | 4669 |
| | 3 | 0 | 0 | 43 | 45 | 521 | 528 | 1137 |
| | 4 | 0 | 0 | 5 | 9 | 104 | 157 | 275 |
| | 5 | 0 | 0 | 0 | 1 | 0 | 5 | 6 |
| 1982 | 2 | 37 | 103 | 886 | 202 | 881 | 1287 | 3396 |
| | 3 | 1 | 7 | 303 | 56 | 148 | 484 | 999 |
| | 4 | 0 | 0 | 14 | 2 | 5 | 17 | 38 |
| | 5 | 0 | 0 | 0 | 0 | 0 | 0 | 0 |
| 1983 | 2 | 51 | 14 | 297 | 250 | 1250 | 658 | 2520 |
| | 3 | 4 | 2 | 35 | 69 | 235 | 80 | 425 |
| | 4 | 0 | 0 | 2 | 4 | 3 | 0 | 9 |
| | 5 | 0 | 0 | 0 | 0 | 0 | 0 | 0 |

TABLE 3. LENGTH AT FIRST WINTER (L_1) (CM).

| YEARCLASS | SEX | AGE WHEN MEASURED | | | | | | | |
|-----------|-----|-------------------|-----|-------------|------|-------------|-----|-------------|-----|
| | | 2 | | 3 | | 4 | | 5 | |
| | | \bar{L}_1 | SD | \bar{L}_1 | SD | \bar{L}_1 | SD | \bar{L}_1 | SD |
| 1975 | F | 5.90 | .74 | 5.33 | 1.01 | 4.96 | .97 | (4.18) | .26 |
| | M | 5.94 | .80 | 5.37 | .96 | 5.08 | .54 | (4.37) | - |
| 1976 | F | 5.92 | .66 | 5.04 | .79 | 4.54 | .68 | (4.12) | - |
| | M | 5.77 | .77 | 5.11 | .82 | 4.88 | .72 | (4.60) | .35 |
| 1977 | F | 5.01 | .72 | 4.33 | .74 | 3.90 | .71 | - | - |
| | M | 5.11 | .80 | 4.32 | .74 | 4.23 | .57 | - | - |
| 1978 | F | 4.81 | .74 | 4.70 | .76 | 4.86 | .91 | - | - |
| | M | 4.71 | .76 | 4.82 | .91 | 5.00 | .65 | - | - |
| 1979 | F | 5.24 | .89 | 5.34 | .84 | (4.14) | .47 | - | - |
| | M | 5.15 | .92 | 5.45 | .86 | (5.01) | .48 | - | - |
| 1980 | F | 5.08 | .81 | 4.94 | .87 | - | - | - | - |
| | M | 5.03 | .82 | 5.01 | .88 | - | - | - | - |
| 1981 | F | 4.95 | .83 | - | - | - | - | - | - |
| | M | 4.89 | .87 | - | - | - | - | - | - |

Data based on less than 10 individuals are put in parantheses.

Growth of the barents sea capelin of the yearclasses 1975-1981

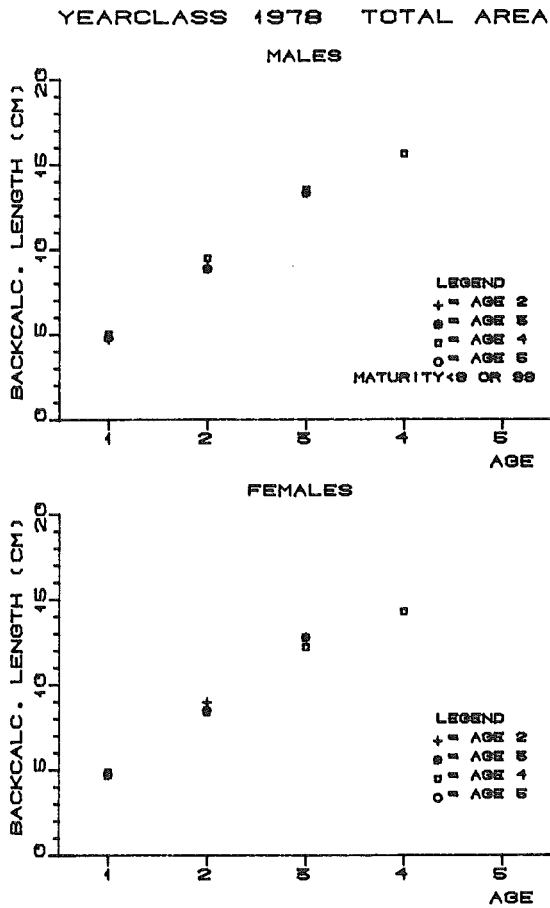


Figure 6. Backcalculated lengths for the 1978 yearclass.

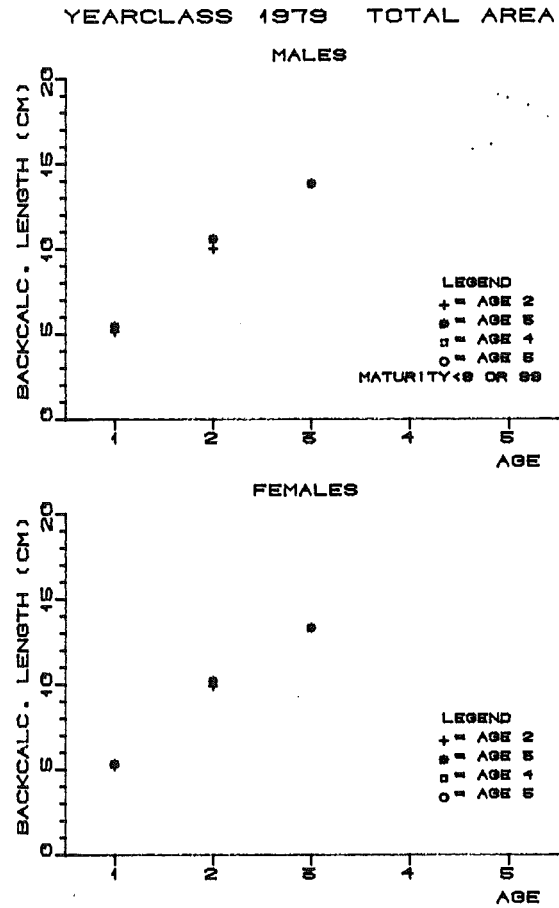


Figure 7. Backcalculated lengths for the 1979 yearclass.

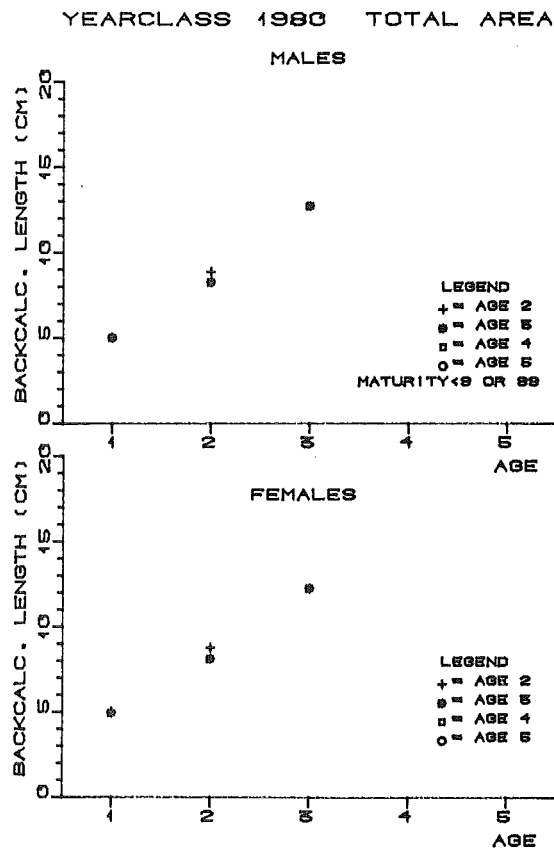


Figure 8. Backcalculated lengths for the 1980 yearclass.

TABLE 4. LENGTH AT SECOND WINTER (L_2) (CM).

| YEARCLASS | SEX | AGE WHEN MEASURED | | | | | | | |
|-----------|-----|-------------------|------|-------------|------|-------------|------|-------------|-----|
| | | 2 | | 3 | | 4 | | 5 | |
| | | \bar{L}_2 | SD | \bar{L}_2 | SD | \bar{L}_2 | SD | \bar{L}_2 | SD |
| 1975 | F | 10.92 | .79 | 10.20 | 1.55 | 8.81 | 1.35 | (7.72) | .32 |
| | M | 11.06 | .94 | 10.25 | 1.47 | 9.09 | 1.10 | (8.27) | - |
| 1976 | F | 10.16 | .83 | 8.70 | 1.24 | 7.98 | 1.13 | (6.03) | - |
| | M | 10.15 | 1.18 | 8.95 | 1.30 | 8.54 | 1.14 | (7.72) | .52 |
| 1977 | F | 9.44 | 1.00 | 8.04 | 1.48 | 7.10 | 1.00 | - | - |
| | M | 9.63 | 1.05 | 8.24 | 1.52 | 7.76 | 1.30 | - | - |
| 1978 | F | 8.97 | 1.35 | 8.49 | 1.47 | 8.38 | 1.25 | - | - |
| | M | 8.94 | 1.47 | 8.85 | 1.82 | 9.47 | 1.20 | - | - |
| 1979 | F | 9.97 | 1.25 | 10.19 | 1.20 | (8.72) | .61 | - | - |
| | M | 10.00 | 1.27 | 10.58 | 1.30 | (9.74) | .68 | - | - |
| 1980 | F | 8.91 | 1.54 | 8.13 | 1.49 | - | - | - | - |
| | M | 8.85 | 1.67 | 8.26 | 1.56 | - | - | - | - |
| 1981 | F | 8.86 | 1.33 | - | - | - | - | - | - |
| | M | 8.89 | 1.48 | - | - | - | - | - | - |

Data based on less than 10 individuals are put in parantheses.

TABLE 5. LENGTH AT THIRD WINTER (L_3) (CM).

| YEARCLASS | SEX | AGE WHEN MEASURED | | | | | |
|-----------|-----|-------------------|------|-------------|------|-------------|------|
| | | 3 | | 4 | | 5 | |
| | | \bar{L}_3 | SD | \bar{L}_3 | SD | \bar{L}_3 | SD |
| 1975 | F | 12.85 | 1.12 | 11.71 | .85 | (10.29) | .76 |
| | M | 13.05 | 1.37 | 11.92 | .87 | (11.85) | - |
| 1976 | F | 11.97 | 1.11 | 11.50 | .89 | (10.80) | - |
| | M | 12.43 | 1.18 | 12.11 | 1.01 | (10.62) | 1.45 |
| 1977 | F | 12.27 | 1.04 | 11.59 | .90 | - | - |
| | M | 12.71 | 1.12 | 12.30 | .96 | - | - |
| 1978 | F | 12.77 | 1.02 | 12.19 | .82 | - | - |
| | M | 13.32 | 1.36 | 13.51 | .63 | - | - |
| 1979 | F | 13.31 | .95 | (12.18) | .41 | - | - |
| | M | 13.84 | 1.16 | (13.94) | .85 | - | - |
| 1980 | F | 12.28 | 1.11 | - | - | - | - |
| | M | 12.73 | 1.41 | - | - | - | - |

Data based on less than 10 individuals are put in parantheses.

Growth of the barents sea capelin of the yearclasses 1975-1981

4.3 Growth in the current year for 2- to 4-year-olds in each subarea

These growth estimates, calculated as the length at sampling minus the backcalculated length from the outermost winterring, are shown for the years 1977 to 1981 in tables 6 to 8, and represented by the distribution mean.

TABLE 6 LENGTH INCREMENTS (CM) AGE-GROUP TWO FOR SUBAREA, YEAR AND SEX GROUP.

| YEAR | SEX | SUBAREAS | | | | | | TOTAL AREA |
|------|-----|----------|--------|--------|------|------|------|------------|
| | | III | IV | V | VI | VII | VIII | |
| 1977 | F | - | - | 2.65 | 2.20 | 2.24 | 2.13 | 2.19 |
| | M | - | - | (2.62) | 2.53 | 2.43 | 2.11 | 2.19 |
| | SUM | - | - | 2.65 | 2.29 | 2.30 | 2.12 | 2.19 |
| 1978 | F | - | 3.32 | 3.38 | 3.23 | 2.92 | 2.90 | 2.97 |
| | M | - | (3.88) | 4.32 | 3.16 | 3.08 | 2.77 | 2.97 |
| | SUM | - | 3.35 | 3.48 | 3.21 | 2.95 | 2.87 | 2.97 |
| 1979 | F | - | - | 4.36 | - | 3.61 | 3.53 | 3.58 |
| | M | - | - | 3.71 | - | 3.52 | 3.23 | 3.32 |
| | SUM | - | - | 4.30 | - | 3.58 | 3.41 | 3.48 |
| 1980 | F | - | - | 3.60 | 2.89 | 3.98 | 3.47 | 3.80 |
| | M | - | - | 3.76 | 3.11 | 4.11 | 3.54 | 3.91 |
| | SUM | - | - | 3.72 | 3.02 | 4.04 | 3.51 | 3.86 |
| 1981 | F | - | - | 3.09 | 4.82 | 2.91 | 2.87 | 2.96 |
| | M | - | - | 3.10 | 5.28 | 3.07 | 2.92 | 3.10 |
| | SUM | - | - | 3.10 | 5.07 | 2.98 | 2.90 | 3.03 |
| 1982 | F | 4.70 | 3.95 | 3.98 | 4.01 | 3.61 | 3.29 | 3.68 |
| | M | 4.82 | 4.12 | 4.05 | 4.27 | 3.79 | 3.38 | 3.79 |
| | SUM | 4.75 | 4.03 | 4.02 | 4.12 | 3.70 | 3.34 | 3.73 |
| 1983 | F | 4.78 | (4.54) | 3.89 | 4.04 | 3.63 | 3.22 | 3.54 |
| | M | 4.58 | 4.04 | 4.54 | 4.30 | 3.62 | 3.28 | 3.58 |
| | SUM | 4.68 | 4.14 | 4.12 | 4.20 | 3.63 | 3.25 | 3.57 |

Mean length increments put in parantheses are based on ten or less individuals and cannot be considered representative for the areas.

' - ' means no data.

TABLE 7 LENGTH INCREMENTS (CM) AGE-GROUP THREE FOR SUBAREAS, YEAR AND SEX GROUP.

| YEAR | SEX | SUBAREAS | | | | | | TOTAL AREA |
|------|-----|----------|--------|------|------|------|------|------------|
| | | III | IV | V | VI | VII | VIII | |
| 1978 | F | - | (2.46) | - | 2.03 | 2.10 | 2.03 | 2.03 |
| | M | - | - | - | 2.55 | 2.54 | 2.28 | 2.36 |
| | SUM | - | (2.46) | - | 2.28 | 2.28 | 2.15 | 2.20 |
| 1979 | F | - | - | 2.24 | - | 2.26 | 2.13 | 2.17 |
| | M | - | - | 2.36 | - | 2.51 | 2.16 | 2.27 |
| | SUM | - | - | 2.31 | - | 2.37 | 2.14 | 2.21 |
| 1980 | F | - | - | 2.66 | 2.40 | 2.86 | 2.62 | 2.72 |
| | M | - | - | 2.86 | 2.59 | 3.15 | 2.75 | 2.96 |
| | SUM | - | - | 2.73 | 2.49 | 3.00 | 2.67 | 2.83 |
| 1981 | F | - | - | 2.11 | 3.68 | 2.28 | 2.35 | 2.33 |
| | M | - | - | 2.25 | 4.10 | 2.41 | 2.43 | 2.47 |
| | SUM | - | - | 2.16 | 3.90 | 2.34 | 2.38 | 2.39 |
| 1982 | F | (2.27) | (2.86) | 2.10 | 3.03 | 2.45 | 2.00 | 2.36 |
| | M | - | (2.16) | 2.26 | 3.37 | 2.81 | 2.16 | 2.55 |
| | SUM | (2.27) | (2.66) | 2.17 | 3.21 | 2.62 | 2.07 | 2.39 |
| 1983 | F | (3.83) | - | 2.73 | 3.23 | 2.53 | 2.26 | 2.46 |
| | M | (4.22) | (3.07) | 3.50 | 3.70 | 2.97 | 2.30 | 2.86 |
| | SUM | (4.02) | (3.07) | 3.07 | 3.55 | 2.72 | 2.27 | 2.63 |

Mean length increments put in parantheses are based on ten or less individuals and cannot be considered representative for the areas.
' - ' means no data.

Growth of the barents sea capelin of the yearclasses 1975-1981

TABLE 8 LENGTH INCREMENTS (CM) AGE-GROUP FOUR FOR SUBAREAS, YEAR AND SEX GROUP.

| YEAR | SEX | SUBAREAS | | | | | | TOTAL AREA |
|------|-----|----------|----|--------|--------|--------|--------|------------|
| | | III | IV | V | VI | VII | VIII | |
| 1979 | F | - | - | (1.62) | - | (2.15) | (1.17) | 1.72 |
| | M | - | - | (0.64) | - | (1.65) | (2.33) | 2.21 |
| | SUM | - | - | (1.13) | - | 1.96 | 2.09 | 2.05 |
| 1980 | F | - | - | 1.61 | (1.85) | 2.19 | 1.96 | 2.06 |
| | M | - | - | (2.31) | (1.80) | 2.43 | 2.24 | 2.36 |
| | SUM | - | - | 1.74 | 1.83 | 2.29 | 2.07 | 2.18 |
| 1981 | F | - | - | (2.25) | (2.73) | 1.69 | 1.90 | 1.80 |
| | M | - | - | (1.86) | (3.36) | 2.09 | 1.98 | 2.10 |
| | SUM | - | - | (1.94) | (3.32) | 1.95 | 1.94 | 1.97 |
| 1982 | F | - | - | (1.33) | - | (1.60) | (1.54) | 1.52 |
| | M | - | - | (1.45) | (2.72) | (1.71) | (1.44) | 1.84 |
| | SUM | - | - | 1.40 | (2.72) | (1.63) | 1.50 | 1.68 |
| 1983 | F | - | - | (2.10) | (1.21) | (1.22) | - | (1.23) |
| | M | - | - | - | (2.11) | - | - | (2.11) |
| | SUM | - | - | (2.10) | (1.89) | (1.22) | - | (1.24) |

Mean length increments put in parantheses are based on ten or less individuals and cannot be considered representative for the areas.

' - ' means no data.

The length increment in the current year is seen to vary between 2.1 and 5.1 cm for the two year olds, but between 2.1 and 3.9 cm for three- year-olds (Table 6 and 7). Despite the considerable overlap in growth between the two age-groups, the two year olds always have a faster growth within area and year. For the four-year-olds, the mean length increments vary between 1.5 and 2.4 cm (Table 8).

The growth difference between the sexes seems to increase with increasing age (Tables 6 to 8 and Figures 6 to 8). While the difference in growth in the second year amounts to only 0.2 mm, the difference increase to 2.3 mm and 4.6 mm in the third and fourth year of life respectively.

4.4 Comparison of growth between areas and years

To facilitate the comparison of growth in areas and years, growth deviations were calculated for each area, based on the average length increments in the area in 1977 to 1983 (A), and the average length increment for all areas (unweighed) each year (B) for males, females and juveniles combined (Table 9 and 10).

Growth of the barents sea capelin of the yearclasses 1975-1981

TABLE 9 GROWTH DEVIATIONS (CM) BETWEEN SUBAREAS FOR AGE-GROUP TWO, SEXES COMBINED.

| YEAR | SUBAREAS | | | | | | | | TOTAL AREA A |
|------|----------|-------|-------|-------|-------|-------|-------|-------|-----------------|
| | Y | | VI | | VII | | VIII | | |
| | A | B | A | B | A | B | A | B | |
| 1977 | -0.98 | +0.31 | -1.36 | -0.05 | -1.01 | -0.04 | -0.94 | -0.22 | -1.07 |
| 1978 | -0.15 | +0.31 | -0.44 | +0.04 | -0.36 | -0.22 | -0.19 | -0.30 | -0.29 |
| 1979 | +0.67 | +0.53 | - | - | +0.27 | -0.19 | +0.35 | -0.36 | +0.22 |
| 1980 | -0.09 | +0.15 | -0.63 | -0.55 | +0.73 | +0.47 | +0.45 | -0.06 | +0.60 |
| 1981 | -0.53 | -0.41 | +1.42 | +1.56 | -0.33 | -0.53 | -0.16 | -0.61 | -0.23 |
| 1962 | +0.39 | +0.02 | +0.47 | +0.13 | +0.39 | +0.29 | +0.28 | -0.65 | +0.47 |
| 1983 | +0.49 | +0.12 | +0.55 | +0.20 | +0.32 | -0.37 | +0.19 | -0.75 | +0.31 |

A = Deviation from average length increment in the area 1977-83

B = Deviation from average length increment in all areas this year.

TABLE 10 GROWTH DEVIATIONS (CM) BETWEEN SUBAREAS FOR AGE-GROUP THREE, SEXES COMBINED.

| YEAR | SUBAREAS | | | | | | | | TOTAL AREA A |
|------|----------|-------|-------|-------|-------|-------|-------|-------|-----------------|
| | Y | | VI | | VII | | VIII | | |
| | A | B | A | B | A | B | A | B | |
| 1978 | - | - | -0.81 | +0.04 | -0.28 | +0.04 | -0.13 | -0.09 | -0.24 |
| 1979 | -0.18 | +0.04 | - | - | -0.19 | +0.10 | -0.14 | -0.13 | -0.23 |
| 1980 | +0.24 | +0.01 | -0.60 | -0.23 | +0.44 | +0.28 | +0.39 | -0.05 | +0.39 |
| 1981 | -0.33 | -0.54 | +0.81 | +1.20 | -0.22 | -0.36 | +0.10 | -0.32 | -0.05 |
| 1982 | -0.32 | -0.35 | +0.12 | +0.69 | +0.16 | +0.10 | -0.21 | -0.45 | -0.05 |
| 1983 | +0.58 | +0.17 | +0.46 | +0.65 | +0.16 | -0.18 | -0.01 | -0.63 | +0.19 |

A = Deviation from average length increment in the area 1977-83

B = Deviation from average length increment in all areas this year.

With few exceptions, an increase in growth has taken place during the years 1977 to 1983, which is also reflected in the weighed mean length increment values for the total stock (Table 6 to 8). The length increment deviations thus show an increasing trend with time, but the growth reach maximum in 1980 and level off afterwards (Table 9 to 10).

4.5 Growth index of areas and years

Based on the data given in Tables 6 and 7 a "growth index" was calculated for each area each year (Table 11). The index is the unweighed mean length increment of the age-groups two and three, both sexes combined, for each area and year.

The growth indices are meant as a basis for comparison between subareas and years. It is calculated from the length increment in the current year for age-group two and three only, as the four-year-olds are not always represented in all subareas. Backcalculated length increments for the 0- and 1-group are also not included, as there may

Growth of the barents sea capelin of the yearclasses 1975-1981

be some doubt that the capelin remains in the same area from age 0 to age 3.

TABLE 11. GROWTH INDICES (UNWEIGHED MEAN LENGTH INCREMENTS FOR BOTH SEXES COMBINED IN AGE-GROUP TWO AND THREE) FOR SUBAREAS AND YEARS.

| YEAR | SUBAREAS | | | | MEAN | TOTAL AREA |
|------|----------|------|------|------|------|------------|
| | V | VI | VII | VIII | | |
| 1978 | - | 2.75 | 2.62 | 2.51 | 2.63 | 2.59 |
| 1979 | 3.31 | - | 2.98 | 2.78 | 3.02 | 2.85 |
| 1980 | 3.23 | 2.76 | 3.52 | 3.09 | 3.15 | 3.35 |
| 1981 | 2.63 | 4.49 | 2.66 | 2.64 | 3.11 | 2.71 |
| 1982 | 3.10 | 3.67 | 3.16 | 2.71 | 3.16 | 3.06 |
| 1983 | 3.60 | 3.88 | 3.18 | 2.76 | 3.36 | 3.10 |
| MEAN | 3.17 | 3.51 | 3.02 | 2.75 | | 2.94 |

5. DISCUSSION

5.1 Growth of the yearclasses

With the exception of the 1978 yearclass, all yearclasses show discrepancies between lengths backcalculated from different age-groups. The differences in L_1 and L_2 backcalculated from two- and three-year-old fish are small, except for the 1977-yearclass, where the three-year-olds show smaller L_1 and L_2 than the 2-group. The four-year-olds, however, have smaller backcalculated lengths than the younger age-groups.

The term "Lee's phenomenon" has been applied to discrepancies of this type, named after Rosa Lee who was the first one to investigate possible causes of the phenomenon. Different explanations have been proposed for this feature of backcalculated growth curves, among which a length selective mortality may be most common.

It is believed that capelin in the Barents Sea experience mass mortality after spawning, although there is not full agreement over whether the mortality is total or not. This mass mortality is very likely length selective, as the maturation of individuals is known to be partly length dependent, at least for the females (Tjelmeland and Forberg 1984). Such a mortality would work in the following way: the larger individuals among the three year olds, which also probably were among the largest at ages one and two, and therefore also have the greatest R_1 and R_2 , will spawn and die, thus removing the upper part of the distribution² of R_1 , R_2 and R_3 for this yearclass, making the mean radii smaller for the surviving part of the yearclass. At age four, the largest among the survivors will mature, spawn and die, thus again removing the upper part of the R-distributions, making the mean R_1 , R_2 and R_3 still smaller. This will continue until there are no survivors left. The mean L_1 , L_2 and L_3 calculated from otoliths from individuals of increasing age, will decrease correspondingly, but will always be representative for the part of the yearclass surviving until sampling.

There is also a possibility for a length-selective fishing mortality. The importance of this is difficult to assess. If the spawning mortality is total, a length-dependent fishing mortality on the spawning stock will have no effect. Conversely, in the autumn fishery, it could affect the calculated growth curves. However, the part of the total stock exploited in this fishery is almost exclusively the part that, in any case, would have entered the spawning stock the next spring, and again, if the spawning mortality is total or nearly so, this will have little or no effect.

In addition to a length selective mortality, sampling error is another possible cause of Lee's phenomenon. If the samples were biased towards greater individuals for the two-year-olds and/or towards smaller individuals for the oldest age-groups, this would have the observed effect on mean R_1 measured for each age-group. Biased sampling could be caused by gear selectivity and/or behavioural differences of age-groups. Unfortunately, we have little exact knowledge of the gear selectivity for capelin in the utilized trawls. The smallest individuals are thought to be underestimated, and this has led to the decision not to include the 0- and 1-group capelin in analyses where an unbiased length distribution is required. However, it is unknown whether gear selectivity on length also might effect the older age-groups. Behavioural differences related to length, either directly or indirectly through length-dependent maturation could for example imply different vulnerability to the sampling gear by dept stratification or amount of schooling. Unfortunately, too little is known about possible mechanisms, and their effect on the sampling. This possibility must be kept in mind when inquiring into the causes of the Lee's phenomenon.

A third possible mechanism for the observed phenomenon is an inadequate backcalculation technique. To test if this explanation could apply for the present study, the mean backcalculated lengths were compared with the corresponding mean otolith radia for the different yearclasses. The result for the yearclass 1975 is shown as an example (Table 12). The decrease in backcalculated lengths is accompanied by a large decrease in otolith radia. This makes it improbable that the decrease in backcalculated lengths is an artifact caused by methodological errors. For this to happen, the L/R-ratio among the fishes in the first winter had to decrease in proportion to the number of years left until sampling. This is, of course, just a theoretical possibility. A methodological error can, however, change the effect a certain change in radius will have on the backcalculated length. It can be shown that, if, for example, the real L/R-relationship was curved either upwards or downwards for increasing values of R, while the intercept of the L-axis was correct, the method used would lower the magnitude of the Lee's phenomenon. The effect of an incorrectly estimated L-intercept would vary with the sign of the difference between true and estimated values. A too low estimated L-intercept would cause a too high range in backcalculated lengths for a given interval on R, and vice versa. The magnitude of this error will decrease for increasing values of R, so while this could have some effect on backcalculated L_1 , the effect on L_2 and L_3 would probably be negligible.

Growth of the barents sea capelin of the yearclasses 1975-1981

TABLE 12 CORRESPONDING VALUES OF R AND BACKCALCULATED L

| YEARCLASS | AGE | R ₁ mm | L ₁ mm | R ₂ mm | L ₂ mm | R ₃ mm | L ₃ mm |
|-----------|-----|----------------------|----------------------|----------------------|----------------------|----------------------|----------------------|
| 1975 | 2 | .229 | 54.0 | .562 | 101.8 | - | - |
| | 3 | .215 | 53.3 | .538 | 101.9 | .721 | 129.0 |
| | 4 | .194 | 50.4 | .454 | 89.9 | .644 | 118.5 |
| | 5 | (.151) | (42.0) | (.410) | (77.7) | (.599) | (104.2) |

It is reasonable to conclude that a length dependent spawning mortality stands as the most probable main cause for the Lee's phenomenon in this stock. If this hypothesis is right, the age at which Lee's phenomenon appears and its magnitude may give some information on the amount of spawning at different age groups.

The growth differences between sexes seems to start at age three and increase thereafter with age (Tables 3 to 8). Lee's phenomenon is more pronounced among the females (Tables 3 to 5), which, if this is caused by length-dependent mortality, implies that females are more affected by this selection than are the males. Various reasons may explain this difference. The females may have a higher spawning mortality rate than the males. Forberg (1982) has shown that female capelin have the potential to spawn more than once, while it is doubtful whether the males have the same potential. Consequently, the males should have a lower probability of surviving the spawning than the females have. However, the males may start the maturation process later, resulting in a lower maturity rate for the youngest age-groups.

It is difficult to test these different hypothesis by means of independent data. Also, a thorough discussion of possible reasons for the observed differences in Lee's phenomenon lies beyond the scope of this paper. It can readily be seen however, that the amount of Lee's phenomenon is not directly linked to length (Tables 3 to 5).

Monstad and Gjøsæter (1977), backcalculating lengths for the 1967-70 yearclasses, found L₁'s about 7% higher than those calculated for the yearclasses 1975 to 1981. L₂ was, however, an average of 15% higher than those calculated in the present study. As for the L₃'s, the mean value for the 1967 - 70 yearclasses was about 5% higher than for the 1975 - 80 yearclass. These differences are not an artifact caused by different backcalculation methods, as they are confirmed by comparison of corresponding mean otolith radia. This indicates a higher mean growth rate of the yearclasses in the period 1967 to 1973 than of those in the period 1975 to 1983. However, Monstad and Gjøsæter (1977) did not take into account possible spatial growth variation, nor did they weigh the data by abundance. A direct comparison of the results should therefore be avoided.

The growth pattern of the yearclasses 1975 to 1981 show some differences (Fig. 3 to 8). This can probably be partly explained by changes in the growth conditions from year to year affecting the yearclasses at different ages. For instance in 1980 the 0-group had an above average growth, the two-group had the best two-group growth in the studied period, and the three-group had the highest growth measured for a three-group, with the effect that the 1978 yearclass, while at age three were among the smallest, got an average length well above the age four average.

5.2 Growth in current year

The growth estimates (Table 6 to 8) cover the period from last winter to sampling in September. There may be some variation in the time of termination of the growing season between areas and years, and this may put some restrictions to the use of these calculated length increments as estimates of the last year of growth. The major part of the growth has, however, probably taken place before this time, so the calculated length increments may give a good indication of the growth in current year. Only in 1977 were more than 10 individuals of five year old fish sampled (Table 2), so nothing can be said about the growth of the five-year-olds. Also the four-year-olds are very poorly represented in the catches, reflecting the low number of older fishes in the stock in the last years.

The highest values are found in the southern part of the sea, areas three, four and five, and the northwestern area, no. six. As the abundance of fish is always highest in the central and northeastern areas, the mean growth for the total stock is only slightly higher than for the two areas seven and eight of slow growth. The length increment values for the total stock of two-year-olds varies between 2.2 and 3.9 cm, the three-year-olds vary between 2.2 and 2.8 cm, and the four-year-olds between 1.7 and 2.2 cm during the years covered, with arithmetic mean values at 3.4, 2.4 and 2.0 cm respectively.

The growth differences between the sexes (Table 6 to 8) is negligible among the two-year-olds, amounting to 0.2 mm in favour of the males. As three year olds, the males show a faster growth in all areas and years, at an average 2.5 mm. The same applies for the four-year-olds, where the difference amounts to 3.5 mm.

Generally the differences between areas are rather small, but 1981 is an exception, as this year the growth in area no. 6 is about 60 % higher than in the other areas for age-groups two to four. In 1980 this area was also exceptional, in that the growth in area 6 is the lowest measured this year.

These results show that although a pattern of growth variations between areas may be recognized, unpredictable variations occur, whose mechanisms are as yet poorly understood.

The comparison of growth between years and areas (Table 7 and 8) shows similar trends for the two- and three-year-old fish. The within-area deviations (A in the tables) are generally negative in the first years of the investigation, but also as late as in 1981 for all areas except no. six. Also, in the last two years, the deviations are generally positive, indicating a general increase in growth of age-groups two and three during the period. The within-year-deviations (B in the tables) reveal that the growth, almost without exception, is lowest in areas seven and eight.

To facilitate the comparison of growth between areas and years, the arithmetic mean of the length increments of two- and three-year-old fish was calculated (Table 11). These "growth indices" (GI) will give an overall picture of the growth variation in space and time. The average GI over the time period for each area and over all areas each year was also calculated (Table 11). Based on these results the areas can be ranked in the order of best growth from six, five, seven and eight. The two areas in the southwestern part of the sea (not included in table 11) is difficult to compare with the others as only with age

group two in the last few years was a significant number of fishes sampled. These years however, the growth seems to have been very good (Tables 6 and 7). A ranking of years would put 1980, 1982 and 1983 on top and 1978, 1979 and 1981 on bottom.

The mechanisms behind these growth differences are unknown. Environmental factors like temperature may be important (Gjøsæter and Loeng 1984), but also factors as competition for food, parts of the population with different growth capacity inhabiting different subareas, maturity and mortality affecting the subpopulations differently etc. could affect the growth in various ways.

6. CONCLUSIONS

Based on the results from this investigation, the following main conclusions may be drawn.

1. The otolith radia and the fish lengths are linearly correlated, and thus the method of backcalculating fish lengths from otolith growth zone radia along straight lines can be applied.
2. The growth is higher in males than in females after the second year of life.
3. The growth decreases with increasing age from the first year of life.
4. The growth is generally higher in the western and southern parts of the Barents Sea than in the northern and eastern parts.
5. The growth is higher in the years 1980 to 1983 than in the period 1977 to 1979.
6. A considerable amount of "Lee's phenomenon" is found. It could be caused by a length dependent spawning mortality, but factors as length selective fishing mortality or sampling errors may also play an important role.
7. Lee's phenomenon is more pronounced among the females than among the males, which can be caused by a higher spawning mortality rate among the females and/or a lower maturity rate among the males.
8. The growth variations are similar in all age-groups during a growth season within a subarea. That is, the growth variations are related to area and/or year, which indicates that environmental factors affect the whole stock in a similar way.

As mentioned introductory, understanding the growth and growth variations in the capelin stock is essential to the management of the resource. If a growth rate could be predicted for the next year based on expected environmental changes, the management could be greatly improved. The growth will affect both the number of fishes entering the spawning stock next year, the number remaining in the immature part of the stock, the spawning stock's gain in weight until the time of spawning, and the growth of the immature part of the population until the autumn fishery next year (Tjelmeland 1984).

The description of the historical growth patterns and growth rates contained in this paper does not allow for such forecasting. However, by comparing these results with relevant data on changes in environmental factors, an understanding of which factors affect the growth could possibly be gained. In the meantime, a longer time series of historical growth should be collected, allowing for an improved base of average historical growth rates for modelling future growth.

7. REFERENCES

- Forberg, K. 1982. A histological study of development of oocytes in capelin, Mallotus villosus villosus (Muller). J. Fish Biol. 20:143-154
- Gjøsaeter, H. 1984. Standard sampling procedure for Barents Sea capelin. A description of standard sampling technique and methods applied to improve the representativeness of the samples. (Contribution to the joint Soviet/Norwegian symposium on Barents Sea capelin, Bergen, August 1984). 12 pp + appendix. [mimeo.] (Included in this volume)
- Gjøsaeter, H. and H. Loeng 1984. Growth of the Barents Sea capelin in relation to water temperature 1977 to 1983. (Contribution to the joint Soviet/Norwegian symposium on the Barents Sea capelin, Bergen, August 1984). 7 pp. [mimeo.]
- Lea, E. 1910. Contribution to the methodics on herring investigations. Cons.Intern. Explor. Mer. Publ. de Circ. No 53.
- Monstad, T. and J. Gjøsaeter 1977. Growth of the Barents Sea capelin of the yearclasses 1967-70. Int. Coun. Explor. Sea. C.M. 1977/H:39 15 pp. [mimeo.]
- Prokhorov, V. S. 1965. Ecology of the Barents Sea capelin (Mallotus villosus Müller) and perspectives for its commercial utilization. Fish Res. Bd. Can. Transl. Ser. 813:1-131 [mimeo.] (Translated from Russian).
- Tempelmann, W. 1968. Review of some aspects of capelin biology in the Canadian area of the Northwest Atlantic. Rapp. P.-v. Rèun. Cons Perm. Int. Explor Mer, 158:41-53.
- Tjelmeland, S. 1984. The capelin assessment model - a documentation. (Contribution to the joint Soviet/Norwegian symposium on the Barents Sea capelin, Bergen August 1984) 15 pp. [mimeo.] (Included in this volume)
- Tjelmeland, S. and K. Forberg. Maturity studies of the Barents Sea capelin. (Contribution to the joint Soviet/Norwegian symposium on the Barents Sea capelin, Bergen August 1984) 9 pp. [mimeo.] (Included in this volume)

MATURITY STUDIES OF BARENTS SEA CAPELIN.

Variations in length at maturity for female capelin.

By

Knut Forberg

Institute of Fisheries
University of Tromsø
P.O. Box 3083 Guleng 9001 Tromsø

and

Sigurd Tjelmeland

Institute of Marine Research
P.O. Box 1870, 5011 Bergen, Nordnes
Norway

ABSTRACT

The sexual maturation of female capelin in the Barents Sea is studied using a new method based on microscope investigation of eggs. A "length at maturity" (L) is defined, and a method for synthesizing the data is developed. The value of L is found to vary considerably between age groups, between areas, and from one year to the next. Some consequences for the TAC calculating procedure are discussed.

1. INTRODUCTION

The sexual maturation of capelin is a key process to management models for the Barents Sea. In the management model presently in use the maturity is implemented as a function of length, such that all fish above a certain length constitute the mature population. This critical length is referred to as length at maturity. Presently total spawning mortality is assumed and the length at maturity is estimated by comparing the age distribution of the stock as calculated from the autumn data to the age composition of the measured stock (Tjelmeland 1984, Hamre and Tjelmeland 1982). If the maturing could be incorporated in the model on the basis of independent data, the model's reliability could be considerably improved. In recent years a method for classification of maturity based on microscope investigations of eggs has been developed (Forberg, 1983). The present paper summarizes some of the results obtained so far, and suggests improvement of the TAC procedure by analysis of the data sources from new angles and by new methods.

2. A NEW METHOD OF DETERMINING MATURITY

In order to improve the methods for estimating the spawning stock and to develop a method for predicting spawning time, a new scale of maturity has been constructed (Forberg, 1983), based on a histological study of maturing sex cells (Forberg, 1982). Maturity is assessed according to morphological structures in fresh or conserved sex cells studied by low power microscopy. This method is inapplicable to male sex cells due to their small size, and the scale only describes the maturity of female capelin.

In the construction of the maturity scale, stages have been ranked from class I (immature) to class IX (degenerating). A description of the class criteria are given in detail by Forberg, (1983), and an abbreviated version is given here:

Classes IIa, IIb, IIIa-IIIc describe maturity when oocyte growth is slow, roughly within the period from June to November.

Class IV describes maturity when yolk accumulates at a high rate, giving rapid growth of the ovary.

Class V capelin are mature, as all the oocytes have ovulated and are loose in the lumen.

Class VI are spawning capelin,

Class VII are spent, and

Class VIII are spent and recovering.

Classes IV, V and VI can with some practice be detected just as well without using a microscope. The term "class", and Roman numerals are used to avoid confusion with the existing scale in which maturity is described in "stages" labelled with Arabic numerals. (Gjøsæter, 1984).

Separation into classes, except for class I, is based on the relative number of second growth phase oocytes (SGP oocytes) within the sample.

The morphology of these oocytes has been described in Forberg, 1982. In the construction of the maturity scale, the description of the transitional condition between immature and early maturing capelin has been emphasized so that ripening fish can be identified as early as possible. Further, the development is described in as many classes as discernible, to facilitate the estimation of the spawning time and to aid in distinguishing between different groups of spawners. Some subclasses are described in order to emphasize minor developmental changes.

To record maturity, a small piece (2X2X2mm) taken from the center of the ovary is spread on a microscope slide and a drop of water added before examination under the microscope using transmitted light. 70X-100X enlargement is used for young stages and about 35X enlargement for advanced stages.

3. A MATHEMATICAL MODEL OF MATURITY

3.1 The maturity function

Figure 1 shows a typical distribution on length and maturity for 2 and 3 year old capelin.

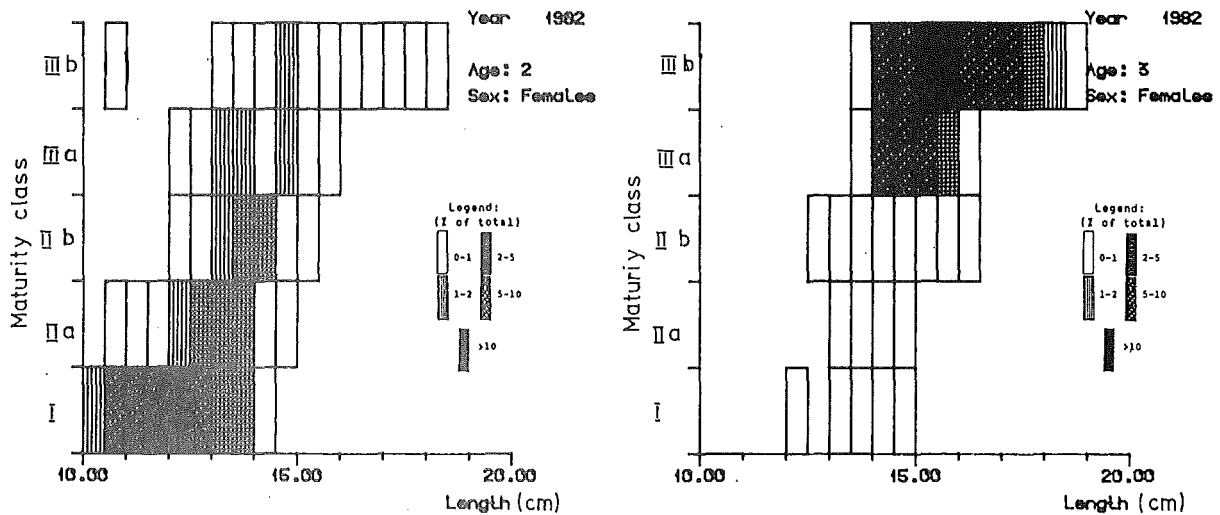


Figure 1. Length distribution within each maturity class (horizontally) and maturity distribution within each 1/2-cm group (vertically) for 2 year old (a) and 3 year old (b) capelin, area VII, 1982.

As is seen from Figure 1, there is a correlation between length and maturity. As the population grows, more fish are found in the higher maturity classes. However, the region in length-maturity space in which the population is found seems to be a little different for 2 and 3 year old fish, the 3 year old fish maturing at smaller size than the 2 year old fish. In order to study variations in maturity independent of the actual length increments of fish it is of importance to find parameters that reflect the correlation between length and maturity. Then variations in these parameters may be studied to reveal

additional dependence on age, environmental conditions etc.

The number of mature capelin within each length group increases with length, compared to the number of immature capelin. Thus, we define the number of mature capelin divided by the total number of capelin in each length group to be the maturation function, $f(l)$. The following mathematical model is suggested for the maturation function:

$$f(l) = \frac{1}{1 + \exp(4I(L-l))}$$

where: $f(l)$ = the fraction of mature fish in each length group.

L = length at which 50 % of the fish are maturing.

I = the increase in maturity with length (maturity rate) at 50% maturity.

This function has the necessary property of approaching zero at low lengths and 1 at great lengths, and being a two-parameter model, it is flexible enough to be well fit to the data at hand. However, maturity is an ambiguous concept, as it is dependent on the maturity class one uses. Thus, the parameters L and I will be different when different maturity classes are used to define the lower limit of the spawning stock. The ultimate goal is to relate some maturity class to the spawning in April and some other class to the later spawning in June-July. Thus, by studying the number of fish in various classes, one can forecast the timing of the coming spawning season. Fig. 2 shows the empirical maturation function and its associated $f(l)$ for the same data displayed in Figure 1.

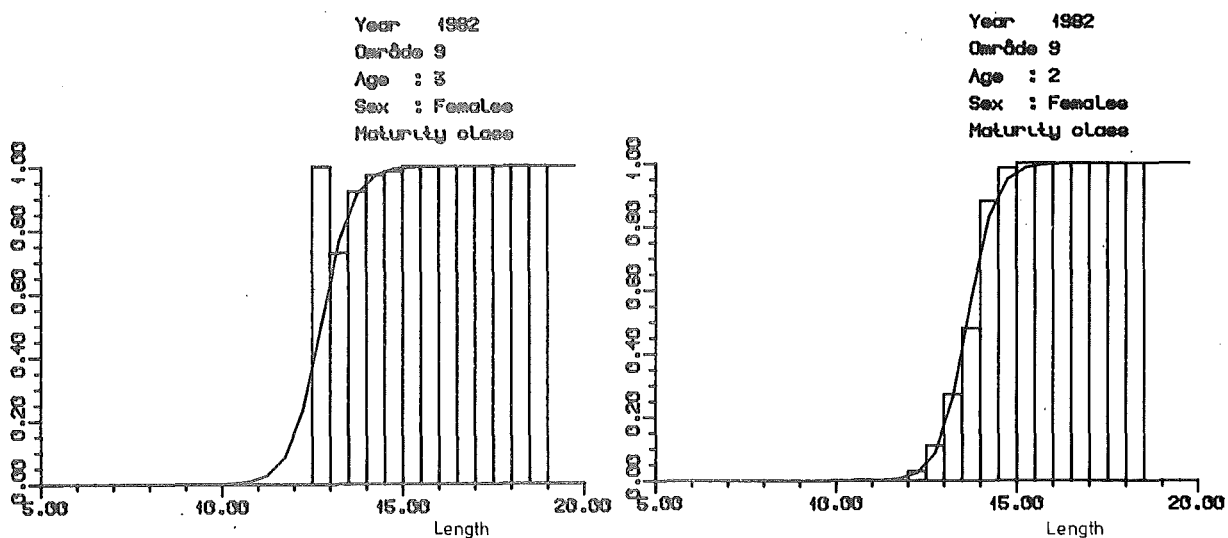


Figure 2. Relative maturity by length as expressed by the maturation function (see the text), for 2 year old and 3 year old capelin, using the same data displayed in Figure 1, and Class IIb as the lower limit of maturity.

3.2 Parameterizing the model

In order to summarize the observations from several years, the parameters L and I must be estimated from the data. Given that the model is correct, the probability of one measured fish being mature is simply given by $f(l)$. For N fish in one length group the probability of exactly r fish being mature is given by the binomial expression

$$h(r) = \frac{N!}{r!(N-r)!} f(l)^r (1-f(l))^{N-r}$$

Given several length groups, and supposing the maturation is described by $f(l)$, the probability of obtaining the measured result will be

$$P = \prod_l h_l$$

where the multiplication is extended over all length groups and all the samples within the region of interest.

Here, we have assumed that the same maturation parameters are valid throughout the whole area in which the samples are taken. These parameters are determined by maximizing the above function. It may be shown (Eadie & al, 1971) that the function

$$-2 \log \frac{P(L, I)}{P(\hat{L}, \hat{I})}$$

is χ^2 -distributed with two degrees of freedom. \hat{L} and \hat{I} are those values of L and I that maximize $P(L, I)$. Using this property the parameter estimates and the corresponding confidence intervals may be calculated.

4. LENGTH AT MATURITY (L) DURING THE PERIOD 1978-1983

4.1 Area variation in L

Using the unweighed data from the two areas in which capelin is most abundant (area VII and VIII, Figure 3) in September each year, L is calculated, with class II b as the lower limit for maturing 3 year old capelin. The result of the calculations is shown in Figure 4. with 75% confidence intervals. There is a significant variation in L between areas. The variation is, however, not consistent from one year to the next, L being significantly larger in area VII than in area VIII in 1978 and 1980, while the opposite is true in 1979 and 1983. The observed variation is probably explained either by different and

varying physical and/or nutritional conditions in the two areas, or by different groups of the maturing population occupying separate habitats which vary from year to year. With this in mind, care should be taken when maturation data from different areas are used.

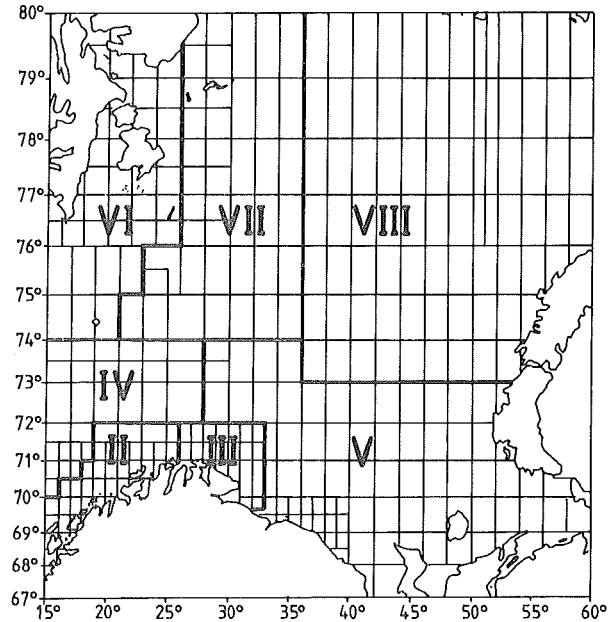


Figure 3. Area division of the Barents Sea.

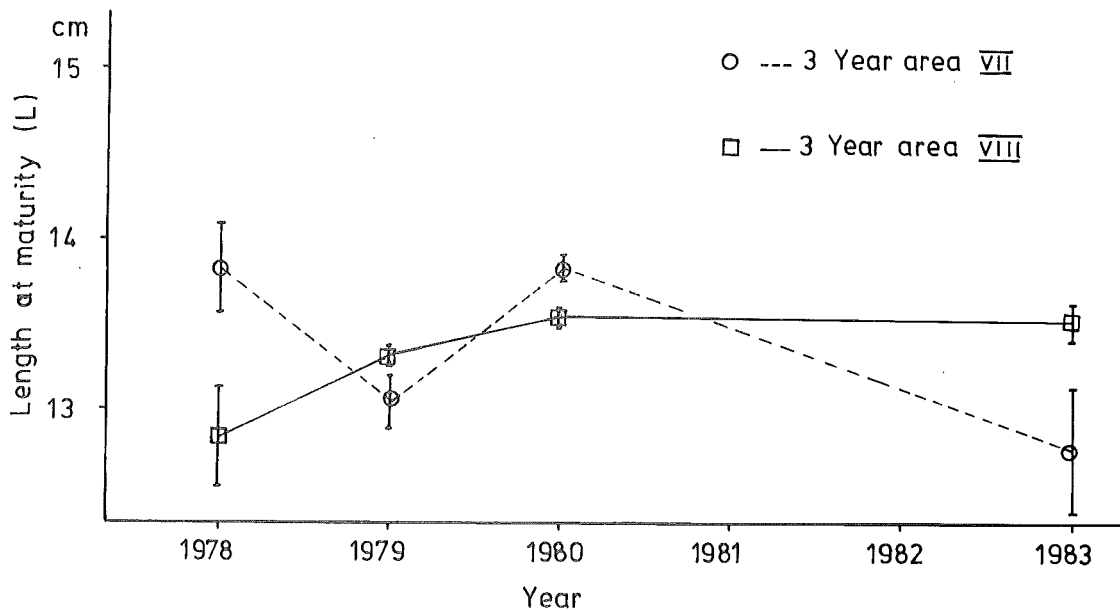


Figure 4. Values of L during 1978 - 1983 for 3 year old capelin from area VII and from area VIII, maturity \geq IIb. Bars represent 75% confidence intervals.

4.2 Annual variation in L

Using the weighed data from cruises in September each year, L is calculated for each of the maturity groups \geq IIa, \geq IIB, \geq IIIa, and \geq IIIb for 3 year old capelin (fig. 5). For the total spawning stock (\geq class IIA/IIB) there is a considerable variation in the L-values during the observed period. The L-values are, however, fairly constant for the most mature group (\geq class IIIb), which probably consists of winter spawners only. The trend of variation of L is rather consistent for all maturity groups. The annual variation in L may reflect actual differences in average spawning length from one year to the next or, more probably, differences in timing of the sexual maturation of capelin.

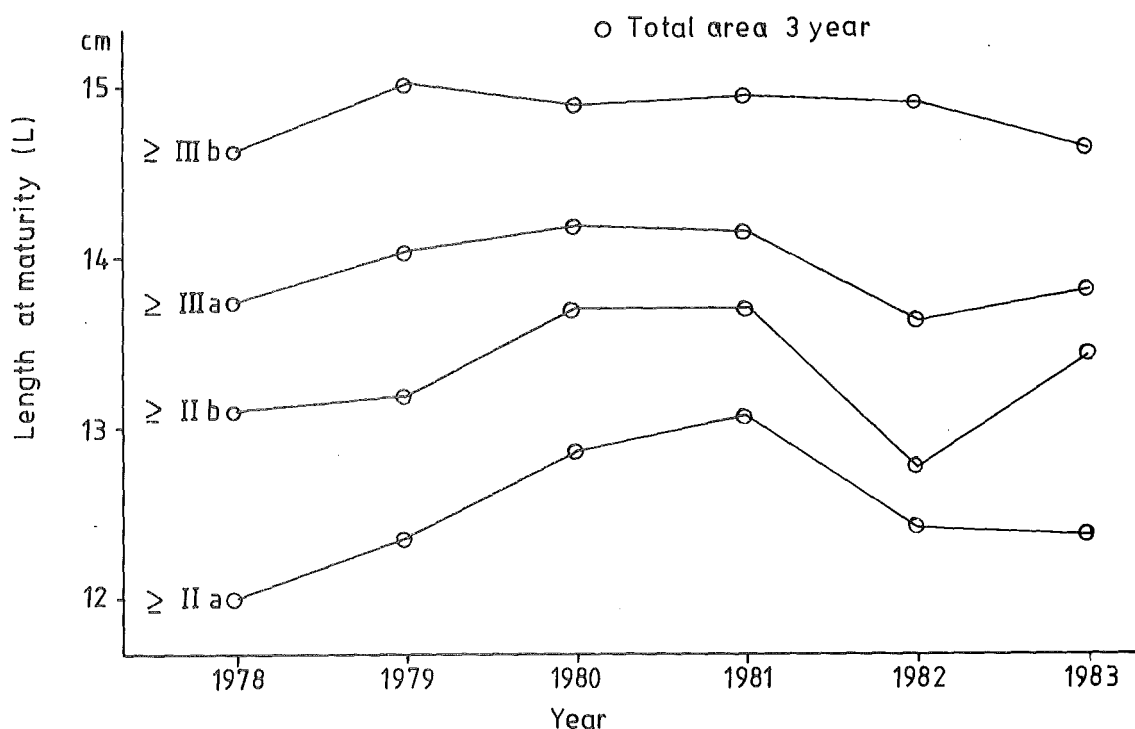


Figure 5. Values of L during the period 1978 - 1983 for different groups of maturing capelin.

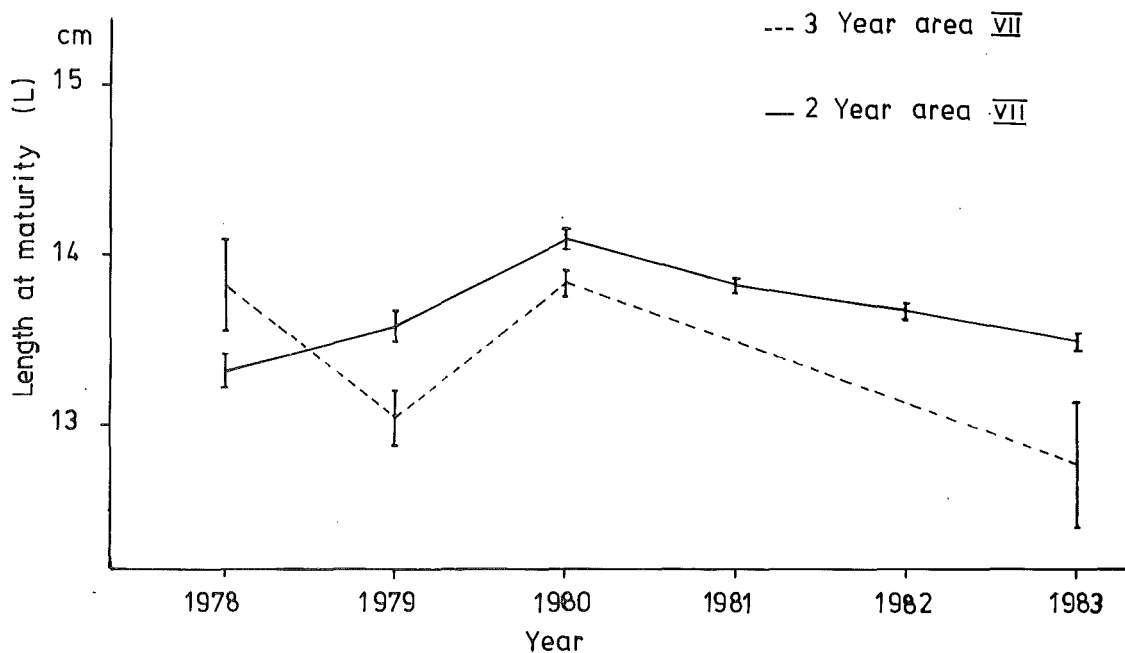
4.3 Age variation in L

Using the unweighed data from the annual cruises in September in area VII, L and the associated 75 % confidence intervals are calculated for 2- and 3-year-old capelin, with Class IIB as a lower limit for the maturing population (Figure 6). The length at maturity for 2-year-old fish is significantly larger than that for 3-year-old fish, except for 1978. 2-year-old capelin are generally smaller than 3-year-old capelin, and for fishes from these groups of the same length, the 2-year-old capelin must have invested a lot more energy per unit time than the 3-year-old capelin in somatic growth. So competing energy requirements may explain differences in maturity rates and, hence, in length at maturity between fishes of different age. A similar relationship was observed in a local stock of capelin in Balsfjord (Forberg, in prep.), between the age group containing only recruits to

the spawning stock and the group one year older containing both recruits and repeated spawners. In this instance, delayed maturity among the former is discussed in relation to the competing energy requirements of two processes:

- 1) High somatic growth during the period of maturation of the young recruits, which delays maturity.
- 2) Repeat-spawners may have developed an ovary structure such that gonad maturation is more energy efficient compared to first time spawners.

The 2-year-old capelin in the Barents Sea probably solely consist of immatures and maturing first time spawners while the 3-year-old capelin consist of both first time spawners and repeat-spawners. Thus, both hypotheses of energy use may apply for the Barents Sea capelin.



Figur 6. Values of L for 2- and 3-year-old capelin, area VII 1978-1983, using Class I Ib as the lower limit of maturity. Bars represent 75% confidence intervals.

5. IMPACT ON THE TAC PROCEDURE

The variation in length at maturity from year to year, between age-groups, and maybe between areas should be taken into account when giving advice on the management of Barents Sea capelin. As it is now, a constant length at maturity is used. Furthermore, the maturation model presently employed treats the length at maturity as a dividing line where all fish below belong to the immature part of the population and all fish above this length belong to the maturing part of the population. However, the most vital question concerning the application of this new maturity scale to a management model has not

been dealt with, that of assessing the maturity of the male part of the population.

If an equally good method of assessing the maturity of males can be found, good estimates of the spring spawning population after an autumn acoustic survey may be obtained. However, in order to use this procedure effectively, the maturity parameters should also be predicted for the next autumn. The reason for this is that the autumn catches are assessed by evaluating the effect on the spawning stock 1 1/2 year ahead in time, as referred to the time of advice. So, the full benefit of the suggested procedure relies on some time-varying or growth-dependent model for the maturity parameters being found. The feasibility of this is not yet known.

6. REFERENCES

- Eadie, W.T., Drijard, D., James, F.E., Roos, M., and Sadoulet, B., 1982. Statistical methods in experimental physics. (North-Holland publishing company, 291 pp).
- Forberg, K. 1982. A histological study of development of oocytes in capelin, Mallotus villosus villosus (Müller). J. Fish. Biol. 20, 143-154.
- Forberg, K. 1983. Maturity classification and growth of capelin, Mallotus villosus villosus (M), oocytes. J. Fish. Biol. 22, 485- 496.
- Forberg, K. in prep. Structure and behaviour of the spawning stock of capelin (Mallotus villosus (M)) in Balsfjord, Northern Norway.
- Gjøsæter, H. 1984. Standard sampling procedure for Barents Sea capelin. A description of standard sampling technique and methods applied to improve the representativeness of the samples. Contribution to the joint Soviet/Norwegian symposium on Barents Sea capelin, Bergen, August 1984. (Included in this volume). 15 pp.
- Hamre, J. and Tjelmeland, S. 1982. Sustainable yield estimates of the Barents Sea capelin stock. Int. Coun. Explor. Sea. C.M.1982/H:45, (mimeo).
- Tjelmeland, S. 1984. The capelin assessment model - a documentation. Contribution to the joint Soviet/Norwegian symposium on the Barents Sea capelin, Bergen August 1984. (Included in this volume). 17 pp.
- Tjelmeland S. and Forberg K. Maturity studies of Barents Sea capelin. A method for assessing early and late spawning capelin. Contribution to the joint Soviet/Norwegian symposium on the Barents Sea capelin, Bergen August 1984. (mimeo). 22 pp.

**SOVIET INVESTIGATIONS OF THE INTRASPECIFIC STRUCTURE
OF THE BARENTS SEA CAPELIN**

by

V.V. Dushchenko

Polar Research Institute of Marine Fisheries and Oceanography (PINRO),
6 Knipovich Street,
183763 Murmansk,
USSR

ABSTRACT

In 1983 the hypothesis of genetic determination of spatial and temporal differentiation of the Barents Sea capelin was tested. The variability of myogens, non-specific esterases and malic enzymes in samples taken during spring and late spawning as well as in those from feeding aggregations was studied by means of electrophoresis in polyacrylamide gel. For the present the obtained material does not give grounds for distinguishing any reproductively isolated groups.

1. INTRODUCTION

The intraspecific structure of the Barents Sea capelin was studied with the aim of genetically distinguishing spring and late-spawning groups sampled over different areas and time of spawning (Rass, 1933; Martinsen, 1933). Genetic characteristics of spatially dispersed concentrations of feeding capelin in different periods of the yearly cycle were also investigated. The paper treats only the data for 1983, and the conclusions should be regarded as preliminary.

2. MATERIALS AND METHODS

Samples of muscle tissue collected and frozen by PINRO research ships were analysed. Proteins were separated in an 8% polyacrylamide gel with an homogenous tris-EDTA-borate buffer system at pH 8.3 (Peacock et al., 1965) and a multipurpose device for vertical electrophoresis (Truveler and Nefedov, 1974). Electropherograms were stained by generally accepted methods (Shaw and Prasad, 1970) with some modifications. Electrophoretic spectra of myogens (My), non-specific esterases (Est) and malic enzymes (ME) were distinguished.

Significant differences between genotype frequencies of samples were estimated by means of χ^2 (Urbakh, 1964). The comparison of genetic frequencies was subjected to a t-test

$$t = \frac{p_1 - p_2}{\sqrt{(s_1^2 + s_2^2)}}$$

where p_1 and p_2 are the sample concentrations of genes and s_1 is the sampling error determined by the formula (Tikhonov, 1967):

$$s_1 = \frac{\sqrt{[p_1(1-p_1)]}}{\sqrt{2n}}$$

where n is the sample volume.

While comparing concentrations of locus alleles in the samples, the t statistic was estimated for one pair with the greatest difference of frequencies. In this case, four rare alleles were not taken into account.

3. RESULTS AND DISCUSSION

Data on genetic variability of the Barents Sea capelin are given in Table 1. The variability of the polymorphic locus of myogens agreed with that described by other authors (Gulev and Nefedov, 1983). It may be assumed that, as concentrations are so low, the locus of myogens should be treated as diallelic. Ten alleles were found in the locus Est-II. The mobility of the corresponding allozymes relative to the monomorphic zone of ceruloplasmin averaged from 1.1 to 2.0. These were numbered from 1 to 10 according to their mobility (Table 3). Activity of malic enzymes was pronounced in two zones, the more mobile of which is controlled by the diallelic locus. The results obtained from analysis of these polymorphic loci are given in Tables 2-4.

The intraspecific structure of the Barents Sea capelin

Table 1. Genetic variability of the Barents Sea capelin.

| Group | Area | Date | Locus | | |
|-----------------------------|-------------------------|----------|-------|--------|------|
| | | | My | Est-II | ME-I |
| Spring spawners | 1. Malangen Bank | 28.02.83 | 200 | 133 | - |
| | 2. Fugløy Bank | 13.02.83 | 223 | 200 | - |
| | 3. Fugløy Bank | 01.02.83 | 200 | 183 | - |
| | 4. Nordkyn Bank | 27.02.83 | 200 | 170 | - |
| | 5. Finnmark Bank | 03.03.83 | 200 | 191 | - |
| | 6. Rybachya Bank | 25.02.83 | 200 | 190 | - |
| Late spawning capelin | 7. Kildin Bank | 08.06.83 | 138 | - | - |
| | 8. Western coastal area | 07.06.83 | 200 | 131 | 40 |
| | 9. Eastern coastal area | 05.06.83 | 200 | 157 | 200 |
| Feeding capelin | 10. South Cape Deep | 19.09.83 | 80 | - | 60 |
| | 11. Perseus Elevation | 18.09.83 | 200 | 193 | 200 |
| | 12. Central elevation | 12.09.83 | 192 | 193 | 195 |
| | 13. Novaya Zemlya Bank | 22.09.83 | 120 | 113 | 120 |

Table 2. Concentrations of genotypes with polymorphic locus of myogens in samples of the Barents Sea capelin.

| Group | Area | Genotype | | | N | χ^2 | pMy _B |
|-----------------------------|-------------------------|----------|-----|----|-----|----------|------------------|
| | | AA | AB | BB | | | |
| Spring spawners | 1. Malangen Bank | 29 | 95 | 76 | 200 | 0.006 | .618 |
| | 2. Fugløy Bank | 28 | 98 | 97 | 223 | 0.175 | .655 |
| | 3. Fugløy Bank | 19 | 102 | 79 | 200 | 2.923 | .650 |
| | 4. Nordkyn Bank | 24 | 81 | 95 | 200 | 1.071 | .678 |
| | 5. Finnmark Bank | 23 | 85 | 92 | 200 | 0.236 | .673 |
| | 6. Rybachya Bank | 29 | 95 | 76 | 200 | 0.006 | .618 |
| Late spawning capelin | 7. Kildin Bank | 19 | 62 | 57 | 138 | 0.106 | .638 |
| | 8. Western coastal area | 28 | 100 | 72 | 200 | 0.517 | .610 |
| | 9. Eastern coastal area | 19 | 83 | 98 | 200 | 0.053 | .698 |
| Feeding capelin | 10. South Cape Deep | 6 | 44 | 30 | 80 | 3.487 | .650 |
| | 11. Perseus Elevation | 34 | 98 | 68 | 200 | 0.017 | .585 |
| | 12. Central elevation | 26 | 86 | 80 | 192 | 0.143 | .641 |
| | 13. Novaya Zemlya Bank | 15 | 50 | 55 | 120 | 0.471 | .667 |

Table 3. Concentrations of alleles in the locus Est-II in samples of the Barents Sea capelin.

| Group | Area | A L L E L E S | | | | | | | | | | N |
|-----------------------------|-------------------------|---------------|-------|-------|-------|-------|-------|-------|-------|-------|-------|-----|
| | | 1 | 2 | 3 | 4 | 5 | 6 | 7 | 8 | 9 | 10 | |
| Spring spawners | 1. Malangen Bank | - | 0.038 | 0.098 | 0.188 | 0.244 | 0.229 | 0.102 | 0.068 | 0.026 | 0.007 | 133 |
| | 2. Fugløy Bank | 0.002 | 0.055 | 0.097 | 0.225 | 0.233 | 0.183 | 0.128 | 0.062 | 0.015 | - | 200 |
| | 3. Fugløy Bank | 0.005 | 0.022 | 0.106 | 0.171 | 0.247 | 0.168 | 0.160 | 0.100 | 0.016 | 0.003 | 183 |
| | 4. Nordkyn Bank | - | 0.021 | 0.082 | 0.156 | 0.235 | 0.191 | 0.195 | 0.115 | 0.009 | - | 170 |
| | 5. Finnmark Bank | - | 0.016 | 0.086 | 0.157 | 0.225 | 0.225 | 0.194 | 0.084 | 0.013 | - | 191 |
| | 6. Rybachya Bank | 0.003 | 0.013 | 0.102 | 0.153 | 0.281 | 0.213 | 0.158 | 0.058 | 0.016 | 0.003 | 190 |
| Late spawning capelin | 8. Western coastal area | - | 0.038 | 0.107 | 0.198 | 0.214 | 0.194 | 0.153 | 0.069 | 0.027 | - | 131 |
| | 9. Eastern coastal area | 0.006 | 0.051 | 0.134 | 0.204 | 0.220 | 0.178 | 0.162 | 0.045 | - | - | 157 |
| Feeding capelin | 11. Perseus Elevation | - | 0.021 | 0.085 | 0.189 | 0.275 | 0.171 | 0.171 | 0.080 | 0.008 | - | 193 |
| | 12. Central elevation | 0.005 | 0.023 | 0.117 | 0.218 | 0.215 | 0.205 | 0.122 | 0.080 | 0.010 | 0.005 | 193 |
| | 13. Novaya Zemlya Bank | - | 0.005 | 0.106 | 0.190 | 0.248 | 0.221 | 0.168 | 0.049 | 0.013 | - | 113 |

The intraspecific structure of the Barents Sea capelin

Comparing some of the frequencies of genes and genotypes in samples of spring- and late-spawners showed that their intragroup variations usually overlap possible intergroup differences. Concentrations of the gene ME-I_B, (Table 4) indicate a small but statistically insignificant isolation of late spawners. Conversely, significant differences are found in concentrations of genes and genotypes of polymorphic loci of myogens and Est-II (Table 1), but this is of the same scale as between spatially dispersed groups both of late and spring spawners. Thus, in two samples taken on the Malangen and Fugløy Banks during spring-spawning, a decline in concentration of the allele Est-II₁ was observed, while samples of late spawners from the Eastern and Western Coastal areas differ in the distribution of myogen phenotypes. The level of capelin populations heterogeneity may be judged by Table 5, where significant differences between all samples are presented. As is seen, the degree of genetic heterogeneity of capelin is rather high, owing, mainly, to spatial differentiation. However, the appearance of differences in concentration of genes and genotypes may theoretically be accounted for by a number of factors including degree of reproductive isolation, selective death or different behavioural mechanisms.

Table 4. Concentrations of genotypes with locus ME-I in samples of the Barents Sea capelin.

| Group | Area | Genotype | | | N | pME-I _B |
|-----------------------|-------------------------|----------|----|-----|-----|--------------------|
| | | AA | AB | BB | | |
| Late spawning capelin | 8. Western coastal area | 1 | 6 | 33 | 40 | .900 |
| | 9. Eastern coastal area | - | 24 | 176 | 200 | .940 |
| Feeding capelin | 10. South Cape Deep | - | 5 | 55 | 60 | .958 |
| | 11. Perseus Elevation | - | 14 | 186 | 200 | .965 |
| | 12. Central elevation | - | 17 | 178 | 195 | .956 |
| | 13. Novaya Zemlya Bank | 1 | 11 | 108 | 120 | .946 |

If we consider those factors in relation to the object of investigation, then the existence of some independent groups is hardly possible. Due to variability in the spawning area and availability of a pelagic stage in ontogeny, the nature and scale of the observed genetic variations are not sufficient to prove isolation of groups. Different selective mechanisms operate in relation to loci ME-I and Est-II, but a more detailed analysis and a greater number of samples are necessary. Differences in concentrations of genes and genotypes of polymorphic locus of myogens, are not connected distinctly with these same mechanisms, because no violation of the Castle-Hardy-Weinberg law was observed in any of the samples.

Proceeding from the above, it seems reasonable at present to consider the Barents Sea capelin as a united population within which panmixia is partly limited by division into smaller sub-populations like those for other species (Altukhov and Rychkov, 1970).

The above data confirm the opinion (Rakhmanova, 1928; Prokhorov, 1965;

The intraspecific structure of the Barents Sea capelin

Luka, 1978) that late-spawning capelin are not an independent intraspecific group.

Table 5. Significance level of the observed differences between samples of the Barents Sea capelin. Significance levels 0.01 and 0.005 are numbered 1 and 2, respectively. Samples are numbered as in table 1.

| Samples | 1 | 2 | 3 | 4 | 5 | 6 | 7 | 8 | 9 | 10 | 11 | 12 | 13 |
|---------|---|---|---|---|---|---|---|---|---|----|----|----|----|
| 1 | - | - | - | 1 | 1 | 2 | - | - | 2 | - | 2 | - | 2 |
| 2 | | - | - | 2 | 2 | 2 | - | - | - | - | 2 | - | - |
| 3 | | | - | - | - | - | - | - | - | - | - | - | 2 |
| 4 | | | | - | - | - | - | - | 1 | - | 2 | 2 | - |
| 5 | | | | | - | - | - | - | - | - | 2 | 2 | - |
| 6 | | | | | | - | - | - | 2 | - | - | 2 | - |
| 7 | | | | | | | - | - | - | - | - | - | - |
| 8 | | | | | | | | - | 2 | - | - | - | - |
| 9 | | | | | | | | | - | - | 1 | - | - |
| 10 | | | | | | | | | | - | - | - | - |
| 11 | | | | | | | | | | | - | - | 2 |
| 12 | | | | | | | | | | | | - | - |
| 13 | | | | | | | | | | | | | - |

4. REFERENCES

- Altukhov, Yu.P. and Yu.G. Rychkov 1970. Populational systems and their structural components. Genetic stability and variability. Zurnal obshchey biologii, 31(5):507-526. (In Russian).
- Guleva, I.B. and G.I. Nefedov 1983. Biochemical polymorphism of muscular esterases and myogens in capelin of the Barents Sea. (Manuscript deposited in VINITI 12 August 1983, No. 4452-83 Dep) 7 pp. (In Russian).
- Luka, G.I. 1978. On systematics and biological groups of capelin in the Barents Sea. Trudy PINRO, 4(1):36-49. (In Russian).
- Martinsen, Yu.V. 1933. On distribution of capelin (Mallotus villosus) in the Barents Sea. Trudy PINRO, 4(1):36-49. (In Russian).
- Peacock, A.C., S.L. Bunting and K.G. Queen 1965. Serum protein electrophoresis in acrylamide gel. Science, 147:1451-1452.
- Prokhorov, V.S. 1965. Ecology of the Barents Sea capelin and perspectives of their commercial exploitation. Trudy PINRO, 19:1-68. (In Russian).
- Rakhmanova, S.I. 1928. On capelin in the Barents Sea. Trudy NIRKh, 3(2):117-130. (In Russian).
- Rass, T.S. 1933. Spawning of capelin (Mallotus villosus Müll.) in the Barents Sea. Trudy PINRO, 4(1):3-33. (In Russian).

The intraspecific structure of the Barents Sea capelin

Shaw, C.R. and R. Prasad 1970. Starch gel electrophoresis of enzymes - a compilation of recipes. Biochemical genetics 4:297-320.

Tikhonov, V.I. 1967. Utilization of blood groups in selection of animals. Kolos Press, 106 pp. (In Russian).

Truveller, K.A. and G.I. Nefedov 1974. Multipurpose device for vertical electrophoresis in parallel plates of polyacrylamide gel. Nauchn. doklady vyssh. shkoly. Ser. Biological Sciences, 9:137-140. (In Russian).

Urbakh, V.Yu. 1964. Biometric methods. Nauka Press, 415 pp. (In Russian).

REPORT ON THE ACOUSTICS WORKSHOP

held at the Soviet/Norwegian symposium on the Barents Sea capelin,
Bergen, Norway 14-19 August 1984

Reported by Odd Nakken (IMR)

The workshop was held Wednesday 15. between 1330 and 1500 hours.

Participants: Z.M. Berdichevskiy (PINRO)
L.I. Serebrov (PINRO)
J. Dalen (IMR)
O. Nakken (IMR)
I. Røttingen (IMR)
T. Jensen (IMR) -interpreter

1. Nakken gave a brief introduction to the echosounder simulator and its use. He also described the education system in fisheries acoustics in Bergen, which includes regular courses for university students in fisheries biology and special courses and job training for electronic engineers and instrument operators.

2. The following points were discussed:

- a) Calibration of acoustic integration systems.
- b) Back scattering cross section and the conversion factor for integration systems.
- c) Data sampling and processing at sea.

The main points in the discussions are given in this report.

A) Calibration

Acoustic calibration is carried out on standard targets according to standard procedures. An ICES manual for calibration is now in preparation at IMR, Bergen and at the Marine Laboratory, Aberdeen and will be approved by the working group on Fisheries Acoustic Science and Technology (ICES) in May 1985.

The acoustic calibration results in a system instrumentation constant. When this constant is applied in the integration, the outputs (integrator values) are in absolute values and directly comparable from vessel to vessel (system to system).

The units of these absolute values of back scattering is in m^2 per unit area. It was agreed that all the acoustic survey data to be exchanged in future should be in absolute values having the dimension:

m^2 per (nautical mile)².

The importance of knowing the exact values of the transducer directivity function was discussed. Observations indicate that the directivity function may change when a transducer is fitted to the hull of the vessel. Directivity measurements of transducers should therefore be undertaken preferably after installation. Both PINRO and IMR will consider this problem.

B. The back scattering cross section and the conversion factor.

The relationship between the back scattering cross section, σ_{bs} , the system instrumentation constant, C_1 and the conversions factor C is:

$$C = \frac{C_1}{\sigma_{bs}}$$

Adopting the values of the conversion factor, C, used for capelin, a target strength to length relationship of

$$TS = 19.1 \log L - 74.5$$

is arrived at.

This relationship gives values of TS which are higher than those arrived at in experimental situations (see paper by Dommasnes and Røttingen at this meeting).

In order to arrive at a more reliable TS - length relationship usable in the abundance estimation, TS - measurements in situ should be carried out by both institutes. Such experiments should include several species: capelin, cod and haddock, blue whiting, herring and polar cod. The work should continue over the next 3-5 years and results should be exchanged and discussed during the yearly March meetings. It is essential that this work is carried out in single species concentrations with narrow length distributions, and that corresponding distributions of target strength, length and weight are obtained. Instrumentation for such work is (or will soon be) available.

C. Data sampling and processing.

This point was only discussed in brief due to lack of time.

REPORT ON THE OTOLITH WORKSHOP

held at the Soviet/Norwegian symposium on the Barents Sea capelin,
Bergen, Norway 14-19 August 1984

Reported by Harald Gjøsæter (IMR)

The workshop was held Wednesday 15. between 1330 and 1500 hours.

Participants: N.G. Ushakov (PINRO)
V.N. Shleinik (PINRO)
O. Alvheim (IMR)
H. Gjøsæter (IMR)

In addition Dir. G.I. Luka attended the workshop without taking part in the practical session on otolith reading.

The participants agreed on the working plan shown below.

1. Practical session on otolith reading.
 - a) Independent reading of some otoliths new to all participants.
 - b) Comparison of the results and discussion of the otoliths using video equipment.
2. Exchange and discussion of the results from the inter-calibration of otolith reading by scientists from the PINRO and the IMR.
3. Discussion of various topics relevant to ageing of capelin.

1. Practical session.

The 23 otoliths read during the workshop were chosen to elucidate different problems in the age-reading. The otoliths were read by all participants independently, after which the readers, who in this report appear by their number only, submitted their results for comparison. (Table 1). All otoliths which had been interpreted differently were then displayed on a video screen for individual discussion, and each reader explained his evaluation of the otolith. Emphasis was not on reaching an agreement, but rather on classifying the otoliths according to the type of problem which lead to the disagreement. However, on some otoliths a full agreement was reached after the discussion.

TABLE 1. Number of otoliths interpreted differently between pairs of readers. A total of 23 otoliths were examined.

| Nos. of otol. differently interpreted | Pairs of readers (referenced by their nos.) | | | | | |
|---|---|-----|-----|-----|-----|-----|
| | 1-2 | 1-3 | 1-4 | 2-3 | 2-4 | 3-4 |
| | 5 | 5 | 4 | 6 | 1 | 5 |

Reader no. 1 and 3 are PINRO scientists, the other two from the IMR. No differences greater than one year were detected. As so few otoliths were read one should be cautious to conclude on any inter- or intra-institute variation. This topic will be discussed in the next section, covering the exchanged otolith samples. More interestingly, those otoliths interpreted differently, could be classified in two groups, namely, those with the first ring problem and those with the false or additional ring problem.

The false ring problem evidently exists, and can hardly be solved. Many criteria are considered, consciously and unconsciously, when discriminating between true and false rings, and hence the variation is due more to individual rather than institutional differences. The otoliths problematic in this respect were considered difficult by all participants. All readers agreed on the more objective criterion for discriminating between true and false rings of considering the otolith growth pattern.

The other difficulty was the first-ring problem. There was some disagreement whether the small first rings of some otoliths should be counted or not. Moreover, there was no consensus over which criteria to use for such discrimination. The PINRO scientists count such rings if some summer growth can be seen inside, while the IMR scientists tend to use the size of the zone as a criterion. Despite this difference, the disagreement over these otoliths was not always between the institutes.

2. The samples exchanged between the PINRO and the IMR.

On a meeting in Murmansk in March 1984 between Soviet and Norwegian scientists it was decided to exchange some samples of capelin otoliths to intercalibrate the ageing carried out on this species. Four samples of otoliths were brought to PINRO and exchanged with four samples read by the Soviet scientists. It was agreed to exchange results at the joint symposium on the Barents Sea capelin in Bergen August 1984. In accordance with this the results from the intercalibration on earlier exchanged otoliths were presented and briefly discussed on the workshop.

2.1 The PINRO samples.

The four samples were brought to the IMR and mounted on otolith plates according to the normal Norwegian procedure. They were then read by two people independently, of which one (no. 1) is a very experienced reader.

The otoliths were classified as good, difficult or impossible to read. Two of the samples were from the winter, and contained mainly older fish. The other two were collected in the autumn, and contained 1-3 year old fish. After the reading, all results were compared from both institutes.

The results, given as per cent deviations between the different readers (number of otoliths read differently in per cent of total number of otoliths) appears in Table 2.

The variation is largest for the spring samples. The percentage of otoliths classified as difficult or impossible by one or both Norwegian readers was also much higher for these samples. This may partly be associated with the higher mean age in these samples.

With only one exception, no deviations greater than one year were found. The number of deviations varied between 3 and 13% between the PINRO-reader and IMR reader no. 1, amounting to an average of 5.75 %. Of these otoliths, about 1/3 were classified as difficult by reader no. 1.

TABLE 2. Percent deviation between pairs of readers.

| Sample no. | Season | PINRO - 1 | PINRO - 2 | 1 - 2 |
|------------|--------|-----------|-----------|-------|
| 1 | winter | 13 | 14 | 11 |
| 2 | winter | 4 | 6 | 5 |
| 3 | autumn | 4 | 5 | 4 |
| 4 | autumn | 3 | 6 | 5 |

It can be seen that the percentage deviation is practically identical between all readers, effectively eliminating institutional differences as a primary cause of the variation.

2.2 The IMR samples.

The results from the PINRO reading of the samples sent from IMR is displayed in Table 3.

TABLE 3. Percent deviation between pairs of readers.

| Sample no. | Season | PINRO-reader - IMR-reader |
|------------|--------|---------------------------|
| 1 | winter | 18 |
| 2 | winter | 0 |
| 3 | autumn | 4 |
| 4 | autumn | 0 |

The PINRO scientists stated that these samples were aged by different readers at PINRO, and some variations appeared between those readers.

3. Conclusions.

After the practical session, and a discussion of the results from the exchanged otolith samples, the workshop reached some conclusions which are recapitulated below.

1. The overall variation in otolith reading between PINRO and IMR seems to be of the same magnitude as that between individual readers at each institute.
2. No systematic differences can be traced between the institutes.
3. The difficulties are of two types, (1) how to interpret small first rings, and (2) how to discriminate false or additional rings from true winterrings.
4. The workshop is of the opinion that the first problem is the most serious, because differences between institutes here could partly be caused by employing different criteria to small first rings. The second problem of false rings can be minimized when samples are aged by experienced readers only.