

REPORT OF THE
**Working Group on the Biology and Assessment of
Deep-Sea Fisheries Resources**

Horta, the Azores, Portugal
4–10 April 2002

This report is not to be quoted without prior consultation with the General Secretary. The document is a report of an expert group under the auspices of the International Council for the Exploration of the Sea and does not necessarily represent the views of the Council.

International Council for the Exploration of the Sea
Conseil International pour l'Exploration de la Mer

Palægade 2–4 DK–1261 Copenhagen K Denmark

TABLE OF CONTENTS

Section	Page
1 INTRODUCTION.....	1
1.1 Terms of Reference	1
2 OVERVIEW	2
2.1 Background	2
2.2 Data availability	3
2.3 Ongoing or recently completed research projects/programmes, and activities of non-ICES advisory groups	3
2.3.1 EC FAIR 95-655 Developing deep-water fisheries: data for their assessment and for understanding their interaction with and impact on a fragile environment (Deep-fisheries)	3
2.3.2 EC DGXIV 97/84 Environment and biology of deep-water species <i>Aphanopus carbo</i> in NE Atlantic: basis for its management (BASBLACK)	3
2.3.3 EC DGXIV 97/81 Seasonal changes in biological and ecological traits of demersal and deep-water fish species in the Azores	4
2.3.4 EC FAIR 98/4365 Otolith microchemistry as a means of identifying stocks of deep-water demersal fish (Otomac)	4
2.3.5 DGXIV Study Contract 99/55 Development of elasmobranch assessment (DELASS).....	4
2.3.6 EU project TECTAC.....	4
2.3.7 EC DGXIV Study Contract: 97/059 Framework for improved European Stock Assessment (FIEFA).....	4
2.3.8 EC DGXIV Study Contract: 99/099 Improving sampling of western and southern European Atlantic fisheries” (SAMFISH)	5
2.3.9 EC FAIR PL 96/1304 Concerted Action: European Fish Ageing Network (EFAN).....	5
2.3.10 UK JNCC Contract	5
2.3.11 BIM Deepwater Programme 2001	5
2.3.12 PROMA collaboration	5
2.3.13 Spanish observer programme on the Hatton Bank (Sub-areas VI and XII, international waters).....	5
2.3.14 EC EVK3/2001/00152- Oceanic Seamounts: an integrated study (OASIS).....	6
2.3.15 Mar-Eco, a Census of Marine Life project in the northern Mid-Atlantic.....	6
2.3.16 European Commission, STEFC <i>Ad hoc</i> working group.....	6
2.3.17 Joint NAFO/ICES/CSIRO symposium on deep-sea fisheries.....	7
2.3.18 National fishery-independent surveys	7
2.4 Summary of landings	9
3 ASSESSMENT METHODOLOGY AND SOFTWARE	16
3.1 Methods	16
3.2 Software	17
4 PRECAUTIONARY APPROACH	18
5 STOCK SUMMARY	19
6 GENERAL	20
6.1 Description of fisheries by nation	20
6.1.1 Faroe Islands	20
6.1.2 France	20
6.1.3 Germany.....	21
6.1.4 Greenland.....	21
6.1.5 Iceland.....	21
6.1.6 Norway.....	21
6.1.7 Portugal.....	22
6.1.8 Russian Federation.....	24
6.1.9 Spain	28
6.1.10 Denmark 29	
6.1.11 Ireland 30	
6.1.12 Netherlands	30
6.1.13 United Kingdom	31
6.2 International waters.....	31
6.3 Stock identity	31
6.3.1 Categories of Deep-water species	32
6.3.2 Species/stock account	32
6.4 Discards	35
6.4.1 Newly reported data on discarding	35
6.4.2 Inventory of existing discard data.....	44

6.5	Inventory of fish community data.....	45
7	LING (MOLVA MOLVA)	47
7.1	Catch Trends	47
7.2	Stocks.....	47
7.3	Catch-effort data	47
7.4	Length Distribution, Age Composition, Mean Weight and Maturity at Age	48
7.5	Biological parameters	48
7.6	Assessment: CPUE analyses and mortality estimates	48
7.7	Comments on Assessment	49
7.8	Management considerations.....	49
8	BLUE LING (MOLVA DYPTERYGIA)	65
8.1	Catch trends	65
8.2	Stocks.....	65
8.3	Catch-Effort Data.....	66
8.4	Length distribution, age composition, mean weight at age, maturity at age, natural mortality.....	66
8.5	Biological parameters	66
8.6	Assessment.....	67
8.7	Comments on assessments	67
8.8	Management considerations.....	67
9	TUSK (BROSME BROSME).....	81
9.1	Catch Trends	81
9.2	Stocks.....	81
9.3	Catch And Effort Data	81
9.4	Length Distribution, Age Composition, Mean Weight At Age, Maturity.....	82
9.5	Biological Parameters	82
9.6	Assessment, CPUE Analyses And Mortality Estimates.....	82
9.7	Comments On Assessment.....	83
9.8	Management Considerations.....	83
10	GREATER SILVER SMELT (<i>ARGENTINA SILUS</i>).....	101
10.1	Catch trends	101
10.2	Stock structure	101
10.3	Commercial catch-effort and research vessel surveys.....	101
10.4	Length and Age compositions and mean weights at age.....	102
10.5	Discards	102
10.6	Biological parameters	102
10.7	Assessment.....	103
10.8	Management considerations.....	103
11	ORANGE ROUGHY (HOPLOSTETHUS ATLANTICUS).....	111
11.1	Catch trends	111
11.2	Stocks.....	111
11.3	Commercial CPUE and research surveys.....	111
11.4	Length and age composition	111
11.5	Biological parameters	111
11.6	Assessment.....	112
	11.6.1 Sub-area VI.....	112
	11.6.2 Sub-area VII.....	112
	11.6.3 Other sub-areas	113
11.7	Comments on the assessment.....	113
11.8	Management considerations.....	113
12	ROUNDNOSE GRENADIER (<i>CORYPHAENOIDES RUPESTRIS</i>).....	121
12.1	Catch trends	121
12.2	Stock identity	121
12.3	Commercial CPUE.....	121

12.4	Age and length composition.....	122
12.5	Discards	122
12.6	Biological data	122
12.7	Assessment.....	123
12.8	Comment on assessment	123
12.9	Management considerations.....	123
13	BLACK SCABBARD FISH (<i>APHANOPUS CARBO</i>).....	135
13.1	Catch trends	135
13.2	Stock structure	135
13.3	Commercial catch and effort data	135
13.4	Length and Age compositions and mean weights at age.....	135
13.5	Biological parameters	136
13.6	Assessment.....	136
13.7	Management considerations.....	137
14	RED (=BLACKSPOT) SEABREAM (<i>PAGELLUS BOGARAVEO</i>).....	147
14.1	Catch trends	147
14.2	Stock structure	147
14.2.1	<i>P. bogaraveo</i> in the Azores region (Sub-area X)	148
14.2.1.1	Commercial LPUE and Research Surveys.....	148
14.2.1.2	Length and Age compositions.....	148
14.2.1.3	Biological parameters	148
14.2.1.4	Assessment.....	149
14.2.1.5	Biological reference points	149
14.2.1.6	Comments on the assessment.....	149
14.2.1.7	Management considerations.....	149
14.2.1.8	<i>P. bogaraveo</i> in Sub-area IX.....	149
14.2.1.9	Commercial CPUE and Research Surveys.....	150
14.2.1.10	Length and Age compositions.....	150
14.2.1.11	Biological parameters	151
14.2.1.12	Assessment.....	152
14.2.1.13	Biological reference points	152
14.2.1.14	Comments on assessment.....	152
14.2.1.15	Management considerations.....	152
14.2.2	<i>P. bogaraveo</i> in Sub-areas VI, VII and VIII.....	152
14.2.2.1	Commercial CPUE and Research Surveys.....	152
14.2.2.2	Length and Age compositions.....	152
14.2.2.3	Biological parameters	152
14.2.2.4	Assessment.....	152
14.2.2.5	Biological reference points	152
14.2.2.6	Comments on assessment.....	153
14.2.2.7	Management considerations.....	153
15	GREATER FORKBEARD (<i>PHYCIS BLENNOIDES</i>)	168
15.1	Catch trends	168
15.2	Stock structure	168
15.3	Commercial CPUE and research surveys.....	168
15.4	Length and age composition	169
15.5	Discards	169
15.6	Biological parameters	170
15.7	Assessment.....	170
15.8	Biological reference points	170
15.9	Comments on Assessment	170
15.10	Management considerations.....	170
16	ALFONSINOS/GOLDEN EYE PERCH (<i>BERYX SPP</i>).....	178
16.1	Catch trends	178
16.2	Stocks.....	179
16.3	Commercial CPUE and Research Surveys.....	179
16.4	Length and Age compositions.....	179

16.5	Biological parameters	179
16.5.1	Age and growth.....	180
16.5.2	Reproduction.....	181
16.6	Assessment.....	182
16.7	Biological reference points	182
16.8	Comments on the Assessment.....	182
16.9	Management considerations.....	182
17	DEEPWATER SQUALID SHARKS CENTROPHORUS SQUAMOSUS AND CENTROSCYMNUS COELOLEPIS	192
17.1	Catch Trends	192
17.2	Stocks	193
17.3	Commercial CPUE and Research Surveys.....	193
17.4	Length and age composition	193
17.5	Biological parameters	194
17.6	Assessment.....	194
17.7	Comments on assessment.....	195
17.8	Management considerations.....	195
18	OTHER SPECIES	210
18.1	Exploratory fishing	210
18.2	Landings and biological information for other species	212
18.2.1	Roughhead grenadier (<i>Macrourus berglax</i>).....	212
18.2.2	<i>Mora moro</i> (Mora) and Moridae.....	212
18.2.3	Rabbit fish (<i>Chimaera monstrosa</i>)	212
18.2.4	Baird's smoothhead (<i>Alepocephalus bairdii</i>).....	212
18.2.5	Wreckfish (<i>Polyprion americanum</i>).....	213
18.2.6	Bluemouth (<i>Helicolenus dactylopterus</i>).....	213
18.2.7	Silver scabbard fish (<i>Lepidopus caudatus</i>)	213
18.2.8	Deep-water cardinal fish (<i>Epigonus telescopus</i>).....	213
19	RECOMMENDATIONS	232
20	REFERENCES AND WORKING DOCUMENTS	234
20.1	References.....	234
20.2	Working Documents	243
APPENDIX 1: RESPONSE TO REQUEST FROM ICES ACE REGARDING THE PROPOSAL FROM OSPAR THAT ORANGE ROUGHT (<i>HOPLOSTETHUS ATLANTICUS</i>) SHOULD BE PLACED ON A LIST OF THREATENED SPECIES		244
APPENDIX 2: DESCRIPTION OF THE ASSESSMENT METHODS USED BY WGDEEP.....		248
APPENDIX 3: MEMBERS OF THE ICES WGDEEP, 2002		254

1 INTRODUCTION

Participants

O.A. Bergstad (Chair)	Norway
W.R. Bowering	Canada
T. Blasdale	United Kingdom
M. Clarke	Ireland
P. Durán Muñoz	Spain
I. Figueiredo	Portugal
J. Gil	Spain
M. Girard	France
J.D.M. Gordon	United Kingdom
K. Helle	Norway
P.A. Large	United Kingdom
P. Lorance	France
P. Lucio	Spain
P. Marchal	France
G. Menezes	Portugal
S. Munch-Petersen	Denmark
J. Palsson	Iceland
M. Pinho	Portugal
Á. Nicolajsen	Faroe Islands
V. Vinnichenko	Russian Federation

1.1 Terms of Reference

At the 2001 Annual Science Conference, it was decided that the **Working Group on the Biology and Assessment of Deep-Sea Fisheries Resources** [WGDEEP] (Chair: O.A. Bergstad, Norway) would meet in Horta, Azores from 4–10 April 2002 to:

- a) assess the status of deep-water species, including blue ling, ling, and tusk, by ICES Sub-area or Division as appropriate;
- b) compile the available data on landings and effort of deep-water species, including blue ling, ling, and tusk, by ICES Sub-area or Division;
- c) update descriptions of deep water fisheries in waters inside and beyond coastal state jurisdiction, for species such as grenadiers, scabbard fishes, orange roughy, forkbeards, sharks, ling, blue ling, and tusk, especially catch statistics by species, fleets and gear – and if possible the biological status of these stocks;
- d) update the data on length/age at maturity, growth and fecundity and document other relevant biological information on deep-water species;
- e) update information on quantities of discards by gear type for the stocks and fisheries considered by this group and make an inventory of deep-water fish community data;
- f) produce a document that discusses the applicability for assessment purposes of different types of survey for different types of deep water species and different hydrographic and bathymetric conditions. The document shall include for each survey type (long line, bottom and pelagic trawl, acoustic, egg production estimation, etc.) a discussion of their advantages and disadvantages.

WGDEEP would report by 20 April 2002 for the attention of ACFM and of the Living Resources Committee.

The point f) of the above Terms of Reference, requesting a document on surveys, was dealt with by WGDEEP in the 2001 report. After consultation with the Secretariat, the group was therefore permitted to refer to the document ICES C.M. 2001/ACFM:23 and not provide a new document on surveys. This report thus concerns the points a) to e) of the Terms of Reference.

Appendix 1 is the WGDEEP response to a request from ICES ACE regarding threatened species and habitats proposed by OSPAR. The group had agreed to consider this task in addition to the above Terms of Reference.

Appendix 3 is a description of assessment methods that have been applied for certain stocks.

Appendix 3 is a list of the current members of WGDEEP and their contact details, including also members who did not attend the 2002 meeting.

2 OVERVIEW

2.1 Background

The first ICES Study Group on the Biology and Assessment of Deep-Sea Fisheries Resources was held in 1994 (C.M. 1995/Assess:4). It provided the background information on what was known about deep-water fisheries within the ICES area and compiled landings data from both official statistics, where available, and from individual members of the Study Group. The report also summarised the current status of knowledge on the biology of these deep-water species. At this time ling, blue ling and tusk were the responsibility of the Northern Shelf Working Group.

The Study Group met by correspondence in 1995 (C.M.1995/Assess:21) but had little to report. The next meeting of the Study Group was in February 1996 (C.M.1996/Assess:8). Its terms of reference were to: (a) compile and analyse available data on a number of deep-water species (namely argentinines, orange roughy, roundnose grenadier, black scabbard fish, golden eye perch (*Beryx splendens*) and red (blackspot) seabream (*Pagellus bogaraveo*)) in the ICES area and, if possible, provide assessments of the state of the stocks and the level of exploitation, and (b) provide information on the stocks and state of exploitation of the stocks of blue ling, ling, and tusk in Sub-areas IIa, IVa, V, VI, VII and XIV and identify outstanding data requirements. The Study Group met by correspondence in 1997 (C.M.1997/Assess:17) and, in addition to updating descriptions of fisheries, the available information on length/age at maturity, growth and fecundity of deep-water species, including blue ling, ling and tusk, was presented in tabular form. The available information on discards was also compiled.

The terms of reference for the 1998 meeting of the Study Group included the additional request to consider the possibility of carrying out assessments of fisheries for deep-sea resources and developing advice consistent with the precautionary approach. The layout of the report (CM 1998/ACFM:12) was modified to conform to the format of an assessment working group report and the existing data were reformatted to allow for year on year updating. The possibilities for carrying out age-structured assessments were very limited, but several provisional assessments were carried out using DeLury constant recruitment and Schaefer production models. The catch and effort assessment methods used by the Group suggested that time series of effort and CPUE may be particularly valuable for the assessment of deep-water species. The Study Group therefore recommended that member states maintain and refine long-term data series and where possible collate historical data. The Study Group recommended that the members be encouraged to provide discard and fish community data.

The Study Group worked by correspondence in 1999 and updated landings statistics and data on biological characteristics. The next (and final) meeting as a Study Group was held in 2000 (ICES CM 2000/ACFM:8), and in addition to carrying out the tasks requested in the previous years, more attempts were made to carry out assessments using catch and effort methods. This was successful for some of the species in some areas, and the results were used for evaluations consistent with the precautionary response. The report was structured so that species-specific sections were provided for those species for which sufficient information was available to provide evaluations of stock status was possible, at least in some areas. As in previous years, it was recognized that the input data remain generally unsatisfactory and that the assessment results should be interpreted with caution. However, it was also concluded that available information showed that many stocks were very probably being exploited at too high levels and some were depleted.

In 2001 the Study Group was re-established as the Working Group on the Biology and Assessment of Deep-Sea Fisheries Resources (WGDEEP), and again worked by correspondence to update landings, fisheries descriptions, discard and biological data, but in addition the Working Group was requested to provide a document on the applicability of fishery-independent surveys for assessment purposes. This document was an integral part of the report (ICES CM 2001/ACFM:23). The report should also address issues raised in special requests to ICES from NEAFC, the Government of Norway and the EU. These requests were considered by ACFM in the May and October sessions (see ICES 2001b, ICES Coop. Res.rep. 246(3), p. 625-641).

In 2001 the assessments of stock status could not be updated, and the last evaluation of the state of the deep-sea stocks were thus provided by ACFM in 2000 (ICES 2000c, ICES Coop. Res. Rep. 242 (2)). The Terms of Reference for the 2002 meeting of WGDEEP includes the evaluation of stock status, and it was therefore a central aim to carry out or update assessments for as many stocks as possible. The conclusions from the ACFM evaluations in 2000 and 2001 formed the important background of the work.

2.2 Data availability

At the end of the 1998 meeting of the Study Group species co-ordinators were appointed to collate available data prior to the meeting and forward them to an assessment co-ordinator. This arrangement facilitated the assessment work at the meeting and was thus continued for the 2002 meeting.

It continues to be a major problem for the assessment of stock status that data on landings and particularly fishing effort are limited or of relatively poor quality. The quality of landings data has improved over the years for most major species, at least from areas within national jurisdiction. Nevertheless, there is still suspicion that not all landings from international waters are forthcoming. Most landings data for 2000 and 2001 were provided by working group members because official statistics provided through ICES were incomplete. A specific problem concerns the non-target species for which landings may be relatively small and scattered. The reporting for such species depends to a large extent on the efforts of individual members of the group, and changes of membership appears to affect this reporting. This may result in inconsistency, and lack of reporting makes compilation of data on such species very difficult.

For major species such as ling and tusk, effort data from major fisheries (i.e. Norwegian and Faroese) could not be updated because of lack of reporting. This prevents the Group from carrying out assessments for these species in most areas. There appears to have been no improvement in this situation since the 2000 meeting.

For a range of species exploited by trawl in the areas west of Scotland, Ireland and France, assessments in 2000 were largely based on the catch per unit of effort data series from French trawlers, i.e. the fleet landing a major proportion of deep-sea fish in these areas. It had been agreed by the Group at its previous meeting that it was especially important to utilise directed effort data where possible to create reasonably reliable CPUE data series for each species. Therefore, data were provided that had been produced by a selection procedure implemented in order to extract data considered to represent directed effort for several target species.

Due to changes in formatting of the French commercial database, directed effort data could not be extracted for 1999 and 2001 (Ch. 6.1.2). As a result, the only updated effort series available from France at this meeting was the total effort directed at all deep-sea species. This presented a significant concern in updating assessments of several stocks. Consequently, comparisons were made between the CPUE based on directed effort and CPUE based on total effort to determine if it was considered reasonable to update assessments using the French CPUE data. The results of these comparisons are included in the species-specific sections below.

Based on these comparisons the Group agreed that useful information could be obtained from updated assessments for most of these stocks even though assessment results from 2002 obtained using total effort may not necessarily be consistent with results reported in 2000.

2.3 Ongoing or recently completed research projects/programmes, and activities of non-ICES advisory groups

2.3.1 EC FAIR 95-655 Developing deep-water fisheries: data for their assessment and for understanding their interaction with and impact on a fragile environment (Deep-fisheries)

The draft final report of this project was available to the Study Group in 2000. The final report is now available to download as a .pdf file from www.sams.ac.uk. The special issue of Fisheries Research (Vol. 51, Parts 2-3) has a brief summary of the aims and results of the project (Gordon 2001a) and also contains many papers that resulted in whole or in part from work done in the project.

2.3.2 EC DGXIV 97/84 Environment and biology of deep-water species *Aphanopus carbo* in NE Atlantic: basis for its management (BASBLACK)

This project, funded by the European Commission (DGXIV in support of the Common Fisheries Policy), began in early 1998. The project was coordinated by Portugal and also had partners from Spain and the United Kingdom. The main objectives were to review the available information on black scabbardfish, establish a sampling programme of landings, investigate stock discrimination, investigate biological parameters (especially growth, feeding, and reproduction); collect relevant data on the habitat and environment, monitor the levels of bioaccumulation and the construction of a data base that includes historical and recent survey and landing information. Whenever georeferenced data was available this database allows a easy transfer into a GIS system. A final report is available (Anon. 2000).

2.3.3 EC DGXIV 97/81 Seasonal changes in biological and ecological traits of demersal and deep-water fish species in the Azores

This project, which was funded by the European Commission (DGXIV in support of the Common Fisheries Policy), began in early 1998 and was coordinated by Portugal with the United Kingdom as a partner. The overall objective was to improve current knowledge on age estimation, growth and reproduction of some of the commercially important demersal and deep-water species exploited in the Azores. Investigations were also carried out on stock discrimination of *Pagellus bogaraveo* and *Beryx splendens* using micro-satellite DNA. The ecological studies included the spatial scales of genetic differentiation of those species for a better understanding of the population biology of the target species. The vertical and horizontal migrations, and the structure of demersal communities between seamounts and the islands margins were also studied. The report is available at the Department of Oceanography and Fisheries (MENEZES G., ROGERS A., KRUG H., MENDONÇA A., STOCKLEY B. M., ISIDRO E., PINHO M. R., FERNANDES A., 2001. Seasonal changes in biological and ecological traits of demersal and deep-water fish species in the Azores. Final report, draft, DG XIV/C/1- study contract 97-081. Universidade dos Açores, University of Southampton, Horta, The Azores. Arquivos do Dop – Série Estudos, Nº 1/2001, 164 p + appendix pp.) or as a PDF file upon request to the author.

2.3.4 EC FAIR 98/4365 Otolith microchemistry as a means of identifying stocks of deep-water demersal fish (Otomic)

This project is being coordinated by the United Kingdom with Spain as a partner. The objective is to use the chemical signal embedded in the otoliths to discriminate between stocks of deep-water species. The underlying principle is that otoliths are inert objects and during their life incorporate a chemical signature of water mass in which they live. Differences in chemical composition, especially in the nucleus, could indicate different origin and hence stock. The project involves both the Atlantic and the Mediterranean. The species involved are the roundnose grenadier (*Coryphaenoides rupestris*), *Nezumia aequalis*, hake (*Merluccius merluccius*), and bluemouth (*Helicolenus dactylopterus*).

2.3.5 DGXIV Study Contract 99/55 Development of elasmobranch assessment (DELASS)

This project is funded by the European Commission, in support of the Common Fisheries policy. The DELASS project involves 15 European research institutes and 2 sub-contractors. The duration of the project is three years (2000-2002) and the main objective is the improvement of the scientific basis for the management in Europe of fisheries taking elasmobranchs. The study contract provides for a work programme for assessing the stock status of 9 elasmobranch species, comprising pelagic sharks, skates, coastal dogfish and deepwater sharks.

The deepwater sharks being considered by the project are *Centroscyrnus coelolepis* and *Centrophorus squamosus* in all ICES areas combined, *Galeus melastomus* in Division IX a and *Dalatias licha* in Sub-area X. The four main tasks of the project are 1) species identification and sampling, 2) stock discrimination, 3) data compilation and 4) stock assessment. The DELASS project aims to support the work of ICES, and preliminary stock assessment exercises will be performed for the 4 case study deepwater sharks at the forthcoming ICES Study Group on Elasmobranch Fisheries, in May 2002.

2.3.6 EU project TECTAC

TECTAC (TEChnological developments and TACTical adaptation of important EU fleets) is a project, which has been earmarked for funding by the EU. The overall objective of this project is to evaluate and predict the impact of various management scenarios on fleet dynamics and fish resource. One case study that will be investigated during this project is the French deep-water fisheries in sub-areas VI and VII. The working group will be kept updated of the findings of this project, which is due to start in September 2002.

2.3.7 EC DGXIV Study Contract: 97/059 Framework for improved European Stock Assessment (FIEFA)

This project, funded by the European Commission (DG XIV in support of the Common Fisheries Policy), began in early 1998 and finished in January 2000. The project was coordinated by Ireland with France, Portugal, Spain (IEO and AZTI) and UK (CEFAS). It was focused mainly on obtaining basic statistics on landings, sampling for length measurements and material for routine age determination of demersal and pelagic species in Sub-area VII, Div. VIIa,b,d and Div. VIIIc & IXa. Information on deep-water species was also obtained from these sea areas.

2.3.8 EC DGXIV Study Contract: 99/099 Improving sampling of western and southern European Atlantic fisheries” (SAMFISH)

This project, funded by the European Commission (DG XIV in support of the Common Fisheries Policy), began in March 2000 and finished in February 2002. The project was coordinated by Spain (AZTI) with Spain (IEO), France, Ireland, Portugal and UK (CEFAS) as partners. Its main objective was to maintain the strength of international sampling of fisheries, data management and data analysis of the most important commercially exploited stocks in ICES Sub-areas: VI, VII, VIII, IX, and X. Information on deep water species was also obtained from these sea areas.

2.3.9 EC FAIR PL 96/1304 Concerted Action: European Fish Ageing Network (EFAN)

This project, funded by the European Commission (DG XIV, in support of the Common Fisheries Policy), began in 1997 and ended in 2000. More than 20 institutes from 13 countries took part in this concerted action coordinated by Norway. The aims were to “develop, conduct and coordinate collaborative research and training, and thereby ensure that age determination becomes a reliable element of the assessments underlying the scientific management advice on fisheries.” Some deep sea species assessed by the WGDEEP were taken into account.

2.3.10 UK JNCC Contract

Under a two year contract with the Joint Nature Conservation Committee of the UK, with partners from the UK (CEFAS, SAMS) and France (IFREMER), the effects of deep-water fishing using trawl survey data from the Rockall Trough were investigated. Some stock assessments were also carried out, and the data and results were made available to the Study Group in 2000. A report is currently being published.

2.3.11 BIM Deepwater Programme 2001

The Fisheries Development Division of the Irish Sea Fisheries Board (BIM) carried out a scientific and technical observer programme during deepwater fishing trials in 2001. New vessels entering the fishery were required to carry observers (BIM, 2002a). Catch and effort, spatial and bathymetric distributions and length frequency data were collected for commercial (BIM, 2002b) and discard species (BIM, 2002c) during the programme. Catch rates by depth interval were also collected. In addition otoliths from a range of species were collected and age estimates were produced by the Central Ageing Facility (CAF), Marine and Freshwater Resources Institute, Queenscliff, Australia. Age estimates and length at age were presented for orange roughy, black scabbard, roundnose grenadier, deepwater redfish, blue ling, wreckfish, bluemouth, conger eel, mora, greater forkbeard, deepwater cardinal, greater argentine, blue antimora, and Baird’s smoothhead (Talman et al., 2002). The reports detailing the programme (BIM, 2002abc; Talman et al. 2002) became available to WGDEEP on the final day of the meeting, and given the time constraints the group were unable to evaluate them in sufficient detail.

2.3.12 PROMA collaboration

Strong collaboration with fishermen started in June 2001 within a collaboration between PROMA and IFREMER. PROMA is a fishermen’s organisation that developed a research activity in order to provide data that is usually not available for assessment. These data are expected to provide useful additional information to fishery catch and effort statistics (Girard *et al.*, 2000) and also landings samplings. Description of the data, methods and preliminary results (specific composition of the discards, CPUE of *Argentina silus* according to the depth and CPUE in *Coryphaenoides rupestris*, *Aphanopus carbo* and “sikis”) have been provided during this WG (Girard 2002, WD).

2.3.13 Spanish observer programme on the Hatton Bank (Sub-areas VI and XII, international waters)

In the year 1996, at the start of the Spanish deep-sea fishery at Hatton Bank, an intensive scientific observer programme was established by agreement between the Spanish Fisheries Administration and the Shipowners’ Associations. Detailed description of this programme is given in Durán Muñoz et al. (2001). The objective is to collect the information required for monitoring the fishery. The Spanish Institute of Oceanography (IEO) in Vigo is responsible of the scientific tasks, while funding is provided by the Institute, Administration and the Shipowners’ Associations. The independent scientific observers provide data on effort, catches and discards by species, depth and position, haul by haul. In addition, length distributions by sex and biological samples are also recorded. This programme provided samples and data for several deep-sea fisheries studies (i.e. otoliths for BASBLACK project). During the period 1996-2001 an average about 23% of the total fishing days were sampled.

2.3.14 EC EVK3/2001/00152- Oceanic Seamounts: an integrated study (OASIS)

This project, funded by the European Commission begins in the summer of 2002 and will last until 2005. The project is coordinated by the University of Hamburg (Germany). The project aims at describing the functional characteristics of seamounts ecosystems, integrating hydrographical, biochemical and biological information.

2.3.15 Mar-Eco, a Census of Marine Life project in the northern Mid-Atlantic

The Mid-Atlantic Ridge and adjacent areas is the target of an emerging international ecosystem study under the Census of Marine Life programme. This project shall gather new knowledge on biodiversity, distribution patterns, and ecological processes, and the overriding aim is “to describe and understand the patterns of distribution, abundance and trophic relationships of the organisms inhabiting the mid-oceanic North Atlantic, and identify and model ecological processes that cause variability in these patterns”. The project will focus on pelagic, benthopelagic and epibenthic macrofauna, and analyse distribution and abundance patterns in relation to the abiotic and biotic environment, as well as trophic relationships and life history strategies. Fish, crustaceans, cephalopods and gelatinous plankton and nekton have the highest priority in the study.

A major challenge of the project is to overcome observation difficulties at large depths and in rugged terrain. A central aim is thus to utilise modern remote sensing technology (acoustics, optics) using advanced instrument carriers (e.g., towed vehicles, ROVs, AUVs etc.).

The project will be carried out as a multi-ship operation in 2003-2005, and the ongoing planning is a collaborative effort involving many nations around the North Atlantic. The project will work on the Mid-Atlantic Ridge and in adjacent waters from the Azores to Iceland, both by surveying large areas by acoustics and mid-water trawling, and by focussing on selected sub-areas for intensive sampling and observation by traditional and novel methods and technology. Overlapping with the field seasons, the period 2004-2008 will be an analytical phase.

An already initiated component project of Mar-Eco is an analysis of population genetics of several of the fish species considered by WGDEEP, and the collection of reference tissue samples has already begun in many slope areas exploited by deep-sea fisheries. Studies of life history strategies of several species are also being planned, and these and other elements of the project will be very relevant for the future work of the Working Group.

Updated information and central documents on Mar-Eco is provided on the website www.mar-eco.no. Participation in component projects of the study is encouraged, and outlines of proposed studies are provided on the website.

2.3.16 European Commission, STEFC *Ad hoc* working group

The European Commission hosted and chaired an open NEAFC hearing on deep-sea species in June 1999. The Commission has further requested ICES for advice on management measures for the various deep-sea fisheries. The Commission's concern over the development of the deep-sea fisheries, and in particular the possible management measure for these fisheries, lead to the establishment in 2001 of a special 'ad hoc' working group under the STECF (Scientific, Technical and Economic Committee for Fisheries), which met in October 2001. The main points in the TOR for this meeting were:

- To review the status of the deep-sea fisheries in community waters (including the Mediterranean).
- To indicate appropriate management and conservation measures for each stock unit.

The report from this meeting (Report of the sub-group Fishery and Environment: Deep-sea fisheries, Brussels 22-26 October 2001, which is available on: www.europarl.eu.int/meetdocs/committees/pech/pech20020326.htm, contains overviews for the NE Atlantic and the Mediterranean of the various fisheries and lists the various possible management measures 'on the market', i.e. technical measures, TAC regulation, effort regulation and, for some fisheries, moratoria.

For the NE Atlantic (ICES areas), it is recommended, that management measures for the various deep-sea fisheries be based on some effort control. It is also stressed, that since most of the deep-sea fisheries are mixed fisheries, application of TACs (by species/stock) for these mixed fisheries is not likely to be an effective manage measure. Thus, if TACs are introduced then these could only be regarded as 'ad hoc' emergency measures, until they can be replaced by effort-based management measures.

In fact, the EU proposal (March 2002) for a council regulation (2002/0053) to regulate the access to fishing on deep-sea stocks also reflects the attitude that TACs are not the appropriate management measures for the deep-sea fisheries.

2.3.17 Joint NAFO/ICES/CSIRO symposium on deep-sea fisheries

The Symposium “Deep-Sea Fisheries”, hosted by NAFO, was held at the Centro de Convenciones de Plaza de Americas, Varadero, Cuba with co-conveners J. A. Moore (NAFO), J. D. M. Gordon (ICES), and J. A. Koslow (CSIRO) from 12-14 September 2001. There were 104 participants from Australia, Austria, Brazil, Canada, Cuba, Denmark, Estonia, Faroe Islands, France, Greece, Iceland, Ireland, Italy, Mexico, New Zealand, Norway, Poland, Portugal, Russia, Spain, United Kingdom, and United States of America.

The Symposium considered current research, advances, and impacts of deepwater fisheries in many different locations around the world. In addition, two sessions were devoted to important deepwater fisheries (Greenland halibut and redfish) of the North Atlantic region. Three invited speakers addressed specific issues within the six sessions. Thirty-five other oral presentations were delivered and 63 posters were displayed. Posters were highlighted in the Greenland halibut session during which five poster authors presented 5-minute summaries of their work.

Day one began with a session on deepwater fisheries, which covered a wide range of topics from exploratory fishing, distribution and gear selectivity. This was followed by a session on Greenland halibut, which considered the effects of fishing on growth, stock structure issues and reproduction. The opening session of the second day began with some papers on the impact of trawling on deep-water corals and other sessile organisms. Two papers covered the deep-water fisheries of the ICES area and options for their assessment. The afternoon session was on biology and life history and described the trophic ecology and biological parameters of a number of deep-water species. The final day comprised a session on redfish and another on fisheries ecology, the latter covering a wide range of topics from age estimation to size spectra.

In the general discussion it was considered that the emerging deep-water fisheries could learn from the experience in managing some of the longer established fisheries such as Greenland halibut and redfish. It was noted that the 2001 report of the ICES Working Group on the Biology and Assessment of Deep-sea Fishery Resources had, at the request of NEAFC, made a first attempt at ranking life history characteristics of deep-water fish in relation to these two species. A recurring theme in many papers was the fact that the current ICES Sub-areas and Divisions are, in many instances, unsuitable in terms of bathymetry and water masses for reporting information on deep-water species. Given the high discard rates and likely high mortality of escapees in trawl fisheries it was considered to be important to report catch and not simply landings. There is increasing public awareness about the impact of fishing activities on the deep-water ecosystem and the conservation of deep-water coral reefs and seamounts were good examples of how there should be wider involvement in the decision making process. The importance of the use of non-invasive technology for studies in the deep-sea, was considered to be an area that should be given greater priority.

Most of the papers read are available as NAFO Scientific Council Reports on www.nafo.ca/meetings/scicoun/2001/resdocs/sertoc.htm, and a more detailed account of the proceedings, the programme and the list of participants are given as a Redbook Report at www.nafo.ca/publications/redbook/2001/index.htm.

2.3.18 National fishery-independent surveys

In the 2001 report of WGDEEP a document discussing the applicability of various surveys for obtaining relevant data for assessments of deep-water fishes was provided. Information was also given on surveys being conducted by different countries. The following is a shortened version of the description of national surveys. Accounts on a Scottish continental slope survey have been added.

Exploratory fishing activities have not been included in this section, but may be found in Section 18.1.

Spain

Since several years ago, the Spanish Institute of Oceanography (IEO) has conducted research surveys in ICES area. A stratified random bottom trawl survey is carried out annually since 1997 in the Svalbard slope (Division IIb), to estimate the biomass and abundance indices of Greenland halibut and other groundfishes. Information on these surveys is presented in the ICES Arctic Fisheries Working Group. A stratified random bottom trawl survey in ICES VII (Porcupine 0991) began in 2001. It is a multi-species survey that samples depths from 190 to 800 meters in two geographic sectors and three depth strata (<200, 200-400 and 400-800). The most abundant species are *Micromesistius poutassou* in the sector 1 and the *Argentina silus* mainly in the sector 2. Trawl surveys may provide swept area biomass estimates. More

information will be given in the 2001 ICES IBTS Working Group in a Working Document format. Also, bottom trawl surveys are carried out in the Cantabrian sea and in the Gulf of Cádiz.

Greenland

Greenland has conducted stratified random bottom trawl surveys in ICES XIVB since 1998, and estimates of biomass and abundance and length frequencies on roundnose and roughhead grenadier were provided for 2000 in the 2001 report. Further, information on sex, length and weight on the very few tusk, ling and different species of elasmobranchs that were recorded during the survey. The utility of this survey for assessment purposes cannot yet be evaluated. Another survey will be conducted in 2002.

Iceland

The Icelandic groundfish survey, which has been conducted annually since 1985, yields information on the variation in time of the fishable biomass of many exploited stocks in Division Va, and also useful information on many other species. More than 500 stations are taken annually, but the survey depth is restricted to the shelf and slope shallower than 500 m. Therefore the survey area does not cover the most important distribution area of ling and blue ling as their distribution extends into greater depths.

An annual deep-water groundfish survey has been carried out all around Iceland since 1996. Although the main target species in this survey are Greenland halibut (*Reinhardtius hippoglossoides*) and deepwater redfish (*Sebastes mentella*), data for all species are collected. These data include length distributions and number of all species caught as well as weight, sex and maturity stages of selected ones.

Portugal (Azores)

Annual longlines surveys were implemented and optimised since 1995 in the Azores using the R/V "Arquipélago". These monitoring surveys aimed to obtain annual relative abundances of demersal and deep-water fish species in the Azores, as well as collect biological material for growth, reproduction and genetics studies of several species. Ecological aspects as horizontal and depth distribution and feeding habits among others, were also carried out. Detailed descriptions and results, of these surveys, can be found in Menezes et al. (1998) and Menezes et al. (1999). Annually the survey covers the main fishing grounds of the region, including all the islands and the major banks and seamounts, and the depths between 25 and 1200 m.

Due to the rough bottom conditions of the Azores archipelago and the depth of the surrounding waters, longlines have proven the most appropriate gear for monitoring surveys of demersal and deep-water fish species in the region. The relative abundances from surveys seem to be a useful independent index of abundance for the most important species, and being so, have already been included in assessment analysis.

Portugal (mainland)

Portugal carries out bottom trawl surveys more or less regularly in Division IXa waters shallower than 900 m. Most of the catches are composed of species which have yet relatively low or no commercial value. The survey does not provide data for assessment of e.g. black scabbardfish.

Ireland

The Marine Institute began a deepwater research survey programme to the west of Ireland in 1993. To date ten surveys have been carried out, five each by trawl and longline. The survey programme was initiated to obtain samples of deepwater fish for biological analysis. The surveys have also produced catch per unit effort (CPUE) and discarding information. Irish experience in conducting such surveys allows for some general points to be made.

Scotland

Since 1998 The Marine Laboratory, Aberdeen has implemented a program of research fishing on the continental slope west of the UK. Fishing is stratified by depth and ranges between 500 and 1300 metres. The survey area extends from the Wyville Thomson Ridge in the north to south of the Hebridean Terrace. Survey methodology followed standard Marlab sampling procedures. Data collected in the form of length frequencies for all species, weight of each species,

length/weight data and biological sampling as required for current projects. Surveys took place in 1998 and 2000 and a further survey is planned for 2002. It is expected that surveys will continue on a biannual basis.

2.4 Summary of landings

The estimated landings of deep-water species by ICES Sub-area and division for the period 1988 to 2001 (preliminary data) are given in Table 2.1. The data in this Table are derived from a variety of sources. Working Group members have provided information that has filled some of the gaps in the STATLANT database but an inspection of the more detailed information presented for each species in the following sections of this report will reveal that the data are still somewhat incomplete. For this reason, some of the apparent trends and fluctuations during the time series should be treated with caution. Some new data not available to previous meetings of the Working Group have been used to refine and correct landings data.

In ICES Sub-area I+II there is directed longline and gillnet fisheries for ling (*Molva molva*) and tusk (*Brosme brosme*). There is also a directed bottom and pelagic trawl fishery for *Argentina silus* and a minor fjord fishery for roundnose grenadier (*Coryphaenoides rupestris*). Landings of *Argentina silus* rose sharply in 2001. Roughhead grenadier (*Macrourus berglax*) is taken as bycatch in the trawl, gillnet and longline fisheries for Greenland halibut and redfish.

In ICES Sub-area III there is a targeted trawl fishery for roundnose grenadier and *Argentina silus*. These species are also a bycatch of the *Pandalus* and *Nephrops* fisheries with trawls, and probably only a minor part of this bycatch is landed.

In ICES Sub-area IV there is a bycatch of *Argentina silus* from the industrial trawl fishery. There is a longline fishery for tusk and ling with forkbeard (*Phycis blennoides*) and some roughhead grenadier as a bycatch. There is a bycatch of some deep-water species in the trawl fisheries targeting *Lophius* spp. and Greenland halibut.

In ICES Sub-area V there are trawl fisheries which target blue ling (*Molva dypterygia*), redfish, argentine (*Argentina silus*) and occasionally orange roughy (*Hoplostethus atlanticus*). By-catch species are typically roundnose grenadier, roughhead grenadier, black scabbard fish (*Aphanopus carbo*), anglerfish (*Lophius piscatorius*), bluemouth (*Helicolenus dactylopterus*), mora (*Mora moro*), greater forkbeard (*Phycis blennoides*), argentine (*Argentina silus*), deep-water cardinal fish (*Epigonus telescopus*) and rabbit fish (*Chimaera monstrosa*). There are traditional longline fisheries for ling and tusk and these species are also bycatches in trawl and gillnet fisheries. There are also targeted trawl and gill net fisheries for Greenland halibut and *Lophius* spp which have deep-water bycatch of for example deep-water red crab (*Chaceon affinis*). There have also been trap fisheries for the deep-water red crab (*Chaceon* (formerly *Geryon*) *affinis*).

In ICES Sub-areas VI and VII there are directed trawl fisheries for blue ling, roundnose grenadier, orange roughy (*Hoplostethus atlanticus*), black scabbard fish and the deepwater sharks *Centroscymnus coelolepis* and *Centrophorus squamosus*. The orange roughy landings doubled from 2000 to 2001, and most of the landings were taken in Sub-area VII. The *Argentina silus* and blue ling landings appear to increase, the former reflecting increased target fisheries. By catch species in these areas include bluemouth (*Helicolenus dactylopterus*), mora (*Mora moro*), greater forkbeard (*Phycis blennoides*), argentine (*Argentina silus*), deep-water cardinal fish (*Epigonus telescopus*) and chimaerids of which *Chimaera monstrosa* is the most important. There are directed longline fisheries for ling and tusk and also for hake. Deep-water sharks are a bycatch of the longline fisheries but there are also targeted fisheries for sharks in Sub-areas VI and VII. There is gill net fishery in Sub-area VII for ling.

In ICES Sub-area VIII there is a longline fishery that mainly targets greater forkbeard (*Phycis blennoides*). There are also some trawl fisheries targeting species such as hake, megrim, anglerfish and *Nephrops* that have a bycatch of deep-water species. These include *Molva* spp., *Phycis phycis*, *Phycis blennoides*, *Pagellus bogaraveo*, *Conger conger*, *Helicolenus dactylopterus*, *Polyprion americanus* and *Beryx* spp.

In ICES Sub-area IX some deep-water species are a bycatch of the trawl fisheries for crustaceans. Typical species are bluemouth (*Helicolenus dactylopterus*), greater forkbeard (*Phycis blennoides*) conger eel (*Conger conger*), blackmouth dogfish (*Galeus melastomus*), kitefin shark (*Dalatias licha*) and gulper shark (*Centrophorus squamosus*). There is a directed longline fishery for black scabbard fish (*Aphanopus carbo*) with a bycatch of the *Centroscymnus coelolepis*. There is also a artisanal longline (Voracera) fishery for *Pagellus bogaraveo*.

In ICES Sub-area X the main fisheries are by handline and longline near the Azores, and the main species landed are red (=blackspot) seabream (*Pagellus bogaraveo*), wreckfish (*Polyprion americanus*), conger eel (*Conger conger*), bluemouth (*Helicolenus dactylopterus*), golden eye perch (*Beryx splendens*) and alfonsino (*Beryx decadactylus*). At present the catches of kitefin shark (*Dalatias licha*) are made by the longline and handline deep-water vessels and can

be considered as accidental. There are no vessels at present catching this species using gillnets. Outside the Azorean EEZ there are trawl fisheries for golden eye perch (*Beryx splendens*), orange roughy (*Hoplostethus atlanticus*), cardinal fish (*Epigonus telescopus*), black scabbard fish (*Aphanopus carbo*), and wreckfish (*Polyprion americanus*).

In ICES Sub-area XII there are trawl fisheries on the Mid-Atlantic Ridge for orange roughy, roundnose grenadier, and black scabbard fish. There is a multi-species trawl and longline fishery on Hatton Bank, and some of this occurs in this sub-area, some in Sub-area VI. There is considerable exploratory fishing on the Hatton Bank, and effort seems to be increasing. Smoothheads seem now to a greater extent to feature in the landings statistics but was previously usually discarded.

In ICES Sub-area XIV there are trawl and longline fisheries for Greenland halibut and redfish that have bycatches of roundnose grenadier, roughhead grenadier and tusk.

Table 2.1 Estimated landings (tonnes) of deep-water species by ICES Sub-areas and Divisions, 1988-2001. Data for 2000 and 2001 are preliminary.

I+II	Species	1988	1989	1990	1991	1992	1993	1994	1995	1996	1997	1998	1999	2000	2001
	ALFONSINOS (<i>Beryx</i> spp.)														
	ARGENTINES (<i>Argentina silus</i>)	11351	8390	9120	7741	8234	7913	6807	6775	6604	4463	8261	7163	6098	14363
	BLUE LING (<i>Molva dypterygia</i>)	3537	2058	1412	1479	1039	1020	422	364	267	292	279	292	252	200
	BLACK SCABBARDFISH (<i>Aphanopus carbo</i>)														
	BLUEMOUTH (<i>Helicolenus dactylopterus</i>)														
	GREATER FORKBEARD (<i>Phycis blennoides</i>)			23	39	33	1								8
	LING (<i>Molva molva</i>)	6126	7368	7628	7793	6521	7093	6322	5954	6346	5409	9200	7651	5964	4950
	MORIDAE														
	ORANGE ROUGHY (<i>Hoplostethus atlanticus</i>)														
	RABBITFISHES (<i>Chimaerids</i>)												1	6	5
	ROUGHHEAD GRENADIER (<i>Macrourus berglax</i>)			589	829	424	136				17	55		48	94
	ROUNDNOSE GRENADIER (<i>Coryphaenoides rupestris</i>)		22	49	72	52	15	15	7	2	106	100	46		2
	RED (=BLACKSPOT) SEABREAM (<i>Pagellus bogaraveo</i>)														
	SHARKS, VARIOUS	37	15												1
	SILVER SCABBARDFISH (<i>Lepidopus caudatus</i>)														
	SMOOTHHEADS (<i>Alepocephalidae</i>)														
	TUSK (<i>Brosme brosme</i>)	14403	19350	18628	18306	15974	17585	12566	11617	12795	9426	15353	17183	14008	12050
	WRECKFISH (<i>Polyprion americanus</i>)														
III+IV	Species	1988	1989	1990	1991	1992	1993	1994	1995	1996	1997	1998	1999	2000	2001
	ALFONSINOS (<i>Beryx</i> spp.)			1		2									
	ARGENTINES (<i>Argentina silus</i>)	2718	3786	2321	2554	5319	3269	1508	1082	3300	2598	3982	4319	2471	1914
	BLUE LING (<i>Molva dypterygia</i>)	385	482	522	648	592	438	442	503	202	291	292	271	144	276
	BLACK SCABBARDFISH (<i>Aphanopus carbo</i>)	2		57				16	2	4	2	9	6	5	12
	BLUEMOUTH (<i>Helicolenus dactylopterus</i>)												5		
	GREATER FORKBEARD (<i>Phycis blennoides</i>)	15	12	115	181	145	34	12	3	18	7	12	31	11	26
	LING (<i>Molva molva</i>)	11933	12486	11025	10943	12154	14249	12288	14112	14531	12325	14472	10472	9858	8375
	MORIDAE														
	ORANGE ROUGHY (<i>Hoplostethus atlanticus</i>)														
	RABBITFISHES (<i>Chimaerids</i>)													15	10
	ROUGHHEAD GRENADIER (<i>Macrourus berglax</i>)					7					36		4		11
	ROUNDNOSE GRENADIER (<i>Coryphaenoides rupestris</i>)	618	1055	1439	2053	2754	1441	771	85	2284	177	1854	3187	2406	3121
	RED (=BLACKSPOT) SEABREAM (<i>Pagellus bogaraveo</i>)														
	SHARKS, VARIOUS				3	133	78	86	20	14	32	359	201	36	62
	SILVER SCABBARDFISH (<i>Lepidopus caudatus</i>)					27									
	SMOOTHHEADS (<i>Alepocephalidae</i>)														
	TUSK (<i>Brosme brosme</i>)	4490	6515	4319	4623	5029	5234	3433	3405	3576	2341	3474	2498	3411	3196
	WRECKFISH (<i>Polyprion americanus</i>)														

Table 2.1 (Continued)															
Va	Species	1988	1989	1990	1991	1992	1993	1994	1995	1996	1997	1998	1999	2000	2001
	ALFONSINOS (<i>Beryx</i> spp.)														
	ARGENTINES (<i>Argentina silus</i>)	206	8	112	247	657	1255	613	492	808	3367	13387	5518	4593	3046
	BLUE LING (<i>Molva dypterygia</i>)	2171	2533	3021	1824	2906	2233	1632	1635	1323	1344	1154	1583	1680	885
	BLACK SCABBARDFISH (<i>Aphanopus carbo</i>)							1			1		9	18	8
	BLUEMOUTH (<i>Helicolenus dactylopterus</i>)														
	GREATER FORKBEARD (<i>Phycis blennoides</i>)														
	LING (<i>Molva molva</i>)	5861	5612	5598	5805	5116	4854	4604	4192	4060	3933	4302	4647	3743	3320
	MORIDAE														
	ORANGE ROUGHY (<i>Hoplostethus atlanticus</i>)				65	382	717	158	64	40	79	28	14	68	19
	RABBITFISHES (<i>Chimaerids</i>)				499	106	3	60	106	21	15		2	4	
	ROUGHHEAD GRENADIER (<i>Macrourus berglax</i>)									15	4	1		5	
	ROUNDNOSE GRENADIER (<i>Coryphaenoides rupestris</i>)	2	4	7	48	210	276	210	398	140	198	120	129	67	57
	RED (=BLACKSPOT) SEABREAM (<i>Pagellus bogaraveo</i>)														
	SHARKS, VARIOUS		31	54	58	70	39	42	45	65	70	87	45	45	57
	SILVER SCABBARDFISH (<i>Lepidopus caudatus</i>)														
	SMOOTHHEADS (<i>Alepocephalidae</i>)					10	3	1	1						
	TUSK (<i>Brosme brosme</i>)	6855	7061	7291	8732	8009	6075	5824	6225	6102	5394	5171	7264	6391	4743
	WRECKFISH (<i>Polyprion americanus</i>)														
Vb	Species	1988	1989	1990	1991	1992	1993	1994	1995	1996	1997	1998	1999	2000	2001
	ALFONSINOS (<i>Beryx</i> spp.)			5		4			1						
	ARGENTINES (<i>Argentina silus</i>)	287	227	2888	60	1443	1063	960	12286	9498	8433	17570	8214	8343	10899
	BLUE LING (<i>Molva dypterygia</i>)	9526	5264	4799	2962	4702	2836	1644	2440	1602	2798	2584	2932	2514	2315
	BLACK SCABBARDFISH (<i>Aphanopus carbo</i>)		166	419	152	33	287	160	424	186	68	180	172	313	620
	BLUEMOUTH (<i>Helicolenus dactylopterus</i>)												58	16	
	DEEP WATER CARDINAL FISH (<i>Epigonus telescopus</i>)												8	2	6
	GREATER FORKBEARD (<i>Phycis blennoides</i>)	2	1	38	53	49	27	4	9	7	7	8	34	32	98
	LING (<i>Molva molva</i>)	4488	4652	3857	4512	3614	2856	3622	4070	4896	5657	5359	5238	3719	4500
	MORIDAE				5								1		
	ORANGE ROUGHY (<i>Hoplostethus atlanticus</i>)			22	48	13	37	170	420	79	18	3	5	155	5
	RABBITFISHES (<i>Chimaerids</i>)								1				3	54	82
	ROUGHHEAD GRENADIER (<i>Macrourus berglax</i>)											9	58	1	4
	ROUNDNOSE GRENADIER (<i>Coryphaenoides rupestris</i>)	1	258	1549	2311	3817	1681	668	1223	1078	1112	1667	1996	1787	1719
	RED (=BLACKSPOT) SEABREAM (<i>Pagellus bogaraveo</i>)														
	SHARKS, VARIOUS		140	78	164	478	192	262	380	308	433	470	409	543	
	SILVER SCABBARDFISH (<i>Lepidopus caudatus</i>)														
	SMOOTHHEADS (<i>Alepocephalidae</i>)														
	TUSK (<i>Brosme brosme</i>)	5665	5122	6181	6266	5391	3439	4316	3978	3310	3319	2710	3964	2974	4004
	WRECKFISH (<i>Polyprion americanus</i>)														

Table 2.1 (Continued)															
VI+VII	Species	1988	1989	1990	1991	1992	1993	1994	1995	1996	1997	1998	1999	2000	2001
	ALFONSINOS (<i>Beryx</i> spp.)		12	8		3	1	5	3	178	25	81	87	100	103
	ARGENTINES (<i>Argentina silus</i>)	10438	25559	7294	5197	5906	1577	5707	7546	5863	7301	5555	8856	13863	15391
	BLUE LING (<i>Molva dypterygia</i>)	9285	9434	6396	7319	6697	5471	4309	4892	6928	7361	8004	9471	8469	11278
	BLACK SCABBARDFISH (<i>Aphanopus carbo</i>)		154	1060	2759	3436	3529	3101	3278	3689	2995	1967	2166	3712	4625
	BLUEMOUTH (<i>Helicolenus dactylopterus</i>)												403	342	137
	DEEP WATER CARDINAL FISH (<i>Epigonus telescopus</i>)												279	241	349
	GREATER FORKBEARD (<i>Phycis blennoides</i>)	1898	1815	1921	1574	1640	1462	1571	2138	3590	2335	3040	3430	4568	4116
	LING (<i>Molva molva</i>)	28092	20545	15766	14684	12671	13763	17439	20856	20838	16668	19863	15087	14123	11237
	MORIDAE				1	25							20	104	95
	ORANGE ROUGHY (<i>Hoplostethus atlanticus</i>)		8	17	4908	4523	2097	1901	947	995	1039	1071	1337	1887	3691
	RABBITFISHES (Chimaerids)							2					236	355	641
	ROUGHHEAD GRENADIER (<i>Macrourus berglax</i>)						18	5	2				34	9	28
	ROUNDNOSE GRENADIER (<i>Coryphaenoides rupestris</i>)	32	2440	5730	7793	8338	10121	7860	7767	7095	7070	6364	6538	9790	10131
	RED (=BLACKSPOT) SEABREAM (<i>Pagellus bogarada</i>)	252	189	134	123	40	22	10	11	29	56	17	25	20	50
	SHARKS, VARIOUS	85	40	43	254	639	1392	1864	2099	2176	3240	3023	1791	8	
	SILVER SCABBARDFISH (<i>Lepidopus caudatus</i>)						2						18	15	
	SMOOTHHEADS (Alepocephalidae)										7				
	TUSK (<i>Brosme brosme</i>)	3002	4086	3216	2719	2817	2378	3233	3085	2417	1832	2240	1654	4415	2669
	WRECKFISH (<i>Polyprion americanus</i>)	7		2	10	15				83		12	14	14	17
VIII+IX	Species	1988	1989	1990	1991	1992	1993	1994	1995	1996	1997	1998	1999	2000	2001
	ALFONSINOS (<i>Beryx</i> spp.)			1		1		2	82	88	135	269	198	160	224
	ARGENTINES (<i>Argentina silus</i>)														
	BLUE LING (<i>Molva dypterygia</i>)										14	33	29		
	BLACK SCABBARDFISH (<i>Aphanopus carbo</i>)	2602	3473	3274	3979	4389	4513	3429	4272	3815	3556	3152	2752	2404	2767
	BLUEMOUTH (<i>Helicolenus dactylopterus</i>)												31	36	34
	DEEP WATER CARDINAL FISH (<i>Epigonus telescopus</i>)												3	5	3
	GREATER FORKBEARD (<i>Phycis blennoides</i>)	81	145	234	130	179	395	320	384	456	361	665	377	383	451
	LING (<i>Molva molva</i>)	1028	1221	1372	1139	802	510	85	845	1041	1034	1799	451	281	509
	MORIDAE								83	52	88			20	18
	ORANGE ROUGHY (<i>Hoplostethus atlanticus</i>)					83	68	31	7	22	23	14	39	52	20
	RABBITFISHES (Chimaerids)												2	2	7
	ROUGHHEAD GRENADIER (<i>Macrourus berglax</i>)														
	ROUNDNOSE GRENADIER (<i>Coryphaenoides rupestris</i>)			5	1	12	18	5		1		20	16	9	10
	RED (=BLACKSPOT) SEABREAM (<i>Pagellus bogarada</i>)	826	948	906	666	921	1175	1135	939	1001	1036	981	647	689	445
	SHARKS, VARIOUS	3545	1789	1789	2850	6590	3740	4	43	64	1104	2890	2287	704	549
	SILVER SCABBARDFISH (<i>Lepidopus caudatus</i>)	2666	1385	584	808	1374	2397	1054	5672	1237	1725	966	4653	30	24
	SMOOTHHEADS (Alepocephalidae)										7				
	TUSK (<i>Brosme brosme</i>)	1										1			
	WRECKFISH (<i>Polyprion americanus</i>)	198	284	163	194	269	338	409	393	294	214	227	151	121	165

Table 2.1 (Continued)															
X	Species	1988	1989	1990	1991	1992	1993	1994	1995	1996	1997	1998	1999	2000	2001
	ALFONSINOS (<i>Beryx</i> spp.)	225	260	338	371	450	728	1500	623	536	983	228	175	229	199
	ARGENTINES (<i>Argentina silus</i>)														
	BLUE LING (<i>Molva dypterygia</i>)	18	17	23	69	31	33	42	29	26	21	13	10	13	
	BLACK SCABBARDFISH (<i>Aphanopus carbo</i>)				166	370	2		3	11	3	99	112	113	
	BLUEMOUTH (<i>Helicolenus dactylopterus</i>)												320	452	301
	DEEP WATER CARDINAL FISH (<i>Epigonus telescopus</i>)													3	
	GREATER FORKBEARD (<i>Phycis blennoides</i>)	29	42	50	68	81	115	135	71	45	30	38	41	94	83
	LING (<i>Molva molva</i>)														
	MORIDAE	18	17	23	36	31	33	42							
	ORANGE ROUGHY (<i>Hoplostethus atlanticus</i>)						1			471	6	177	10	188	28
	RABBITFISHES (<i>Chimaerids</i>)														
	ROUGHHEAD GRENADIER (<i>Macrourus berglax</i>)												3		
	ROUNDNOSE GRENADIER (<i>Coryphaenoides rupestris</i>)									3	1	1	6	74	
	RED (=BLACKSPOT) SEABREAM (<i>Pagellus bogaraveo</i>)	637	924	889	874	1110	829	983	1096	1036	1012	1114	1222	947	1034
	SHARKS, VARIOUS	1098	2703	1204	3864	4241	1183	309	1246	1117	859	995			
	SILVER SCABBARDFISH (<i>Lepidopus caudatus</i>)	70	91	120	166	2160	1722	373	789	815	1115	1186	86	28	14
	SMOOTHHEADS (<i>Alepocephalidae</i>)														
	TUSK (<i>Brosme brosme</i>)														
	WRECKFISH (<i>Polyprion americanus</i>)	191	235	224	170	237	311	428	240	240	177	139	133	268	232
XII	Species	1988	1989	1990	1991	1992	1993	1994	1995	1996	1997	1998	1999	2000	2001
	ALFONSINOS (<i>Beryx</i> spp.)								2						
	ARGENTINES (<i>Argentina silus</i>)						6			1			2		
	BLUE LING (<i>Molva dypterygia</i>)	263	70	5	1147	971	3335	752	573	788	417	438	1353	505	839
	BLACK SCABBARDFISH (<i>Aphanopus carbo</i>)					512	1144	824	301	444	200	154	112	244	164
	BLUEMOUTH (<i>Helicolenus dactylopterus</i>)														
	GREATER FORKBEARD (<i>Phycis blennoides</i>)					1	1	3	4	2	2	1		6	8
	LING (<i>Molva molva</i>)			3	10			5	50	2	9	2	2	7	59
	MORIDAE													1	
	ORANGE ROUGHY (<i>Hoplostethus atlanticus</i>)					8	32	93	676	818	808	629	431	104	201
	RABBITFISHES (<i>Chimaerids</i>)										32	42	115	48	63
	ROUGHHEAD GRENADIER (<i>Macrourus berglax</i>)												39	5	
	ROUNDNOSE GRENADIER (<i>Coryphaenoides rupestris</i>)	10600	9500	2800	7510	1997	2741	1161	644	1728	8676	11978	9660	8522	9551
	RED (=BLACKSPOT) SEABREAM (<i>Pagellus bogaraveo</i>)							75							
	SHARKS, VARIOUS				1	2	6	8	139	147	32	56	50	1069	1208
	SILVER SCABBARDFISH (<i>Lepidopus caudatus</i>)		102	20			19								
	SMOOTHHEADS (<i>Alepocephalidae</i>)									230	3692	4643	6549	978	3902
	TUSK (<i>Brosme brosme</i>)	1	1		1	1	12	1	18	158	30	1	1	5	51
	WRECKFISH (<i>Polyprion americanus</i>)														

Table 2.1 (Continued)																
XIV	Species	1988	1989	1990	1991	1992	1993	1994	1995	1996	1997	1998	1999	2000	2001	
	ALFONSINOS (<i>Beryx</i> spp.)															
	ARGENTINES (<i>Argentina silus</i>)			6										217	66	
	BLUE LING (<i>Molva dyptergia</i>)	242	71	79	155	110	3725	384	141	14	4	55	8	532	1181	
	BLACK SCABBARDFISH (<i>Aphanopus carbo</i>)											2		90	12	
	BLUEMOUTH (<i>Helicolenus dactylopterus</i>)															
	GREATER FORKBEARD (<i>Phycis blennoides</i>)															
	LING (<i>Molva molva</i>)	3	1	9	1	17	9	6	17	0	61	6	1	26	35	
	MORIDAE															
	ORANGE ROUGHY (<i>Hoplostethus atlanticus</i>)															
	RABBITFISHES (<i>Chimaerids</i>)															
	ROUGHHEAD GRENADIER (<i>Macrourus berglax</i>)						52	5	2				14	15		
	ROUNDNOSE GRENADIER (<i>Coryphaenoides rupestris</i>)	52	45	47	29	31	26	15	27	25	59	126	124	46	92	
	RED (=BLACKSPOT) SEABREAM (<i>Pagellus bogaraveo</i>)															
	SQUALID SHARKS	2253	2151	3871	5610	7836	7985	7474	6801	7065	6158	6318	5636	7150	9175	
	SHARKS, VARIOUS including some squalids	3630	1860	2026	4453	10429	9044	5757	5383	5974	7579	9602	7655	6764	7874	
	SILVER SCABBARDFISH (<i>Lepidopus caudatus</i>)															
	SMOOTHHEADS (<i>Alepocephalidae</i>)													4158	4121	
	TUSK (<i>Brosme brosme</i>)	2	23	32	135	202	80	25	87	281	118	15	9	11	69	
	WRECKFISH (<i>Polyprion americanus</i>)															

3 ASSESSMENT METHODOLOGY AND SOFTWARE

This section summarises the methods and software used by the Working Group. Two working papers on assessment methodology were submitted. Firstly, a general paper describing a range of non-age based assessment methods (Dobby, 2002), and secondly a paper describing and trialing stock reduction analysis on data for orange roughy in Sub-area VI (Large, 2002). Information from these papers, particularly the general paper, has been incorporated in a detailed description of the methods used at the Working Group attached in Appendix 2. Section 3.1 below provides a simple overview.

3.1 Methods

Catch curve analysis

The Group was aware of the assumption of constant recruitment implied when constructing catch curves within years. Lack of historical data frequently required this course of action rather than the preferred option of analysing individual year classes by cohort.

Depletion models

A catch and effort data analysis package (CEDA) was used to apply modified Delury constant recruitment models when sufficient data were available. The Study Group recognised that depletion models in general assume that data are from a single stock (i.e., there is no immigration or emigration) and that this approach should not be applied to components of stocks or fisheries. Notwithstanding these assumptions, and the lack of knowledge regarding the stock structure of deep-water species, the Group still felt these methods were worth trying as an investigative tool. The general procedure adopted was to use sensitivity analysis to evaluate the effect on results (goodness of fit, residual plots, parameter estimates- principally carrying capacity, catchability and current population size) of a range of assumptions for stock size in the first year as a proportion of carrying capacity and error models. Indexed recruitment depletion models could not be attempted because of a lack of recruit data.

Production models

CEDA was also used to fit dynamic (ie non-equilibrium) Schaefer production models. Again sensitivity analysis of outputs was used to evaluate the effect of error models and ratio of initial to virgin biomass. A time-lag of zero was used in the majority of assessments because available time-series of catch and CPUE were too short (frequently 8-10 years) to explore the effect of time-lag over a range of years commensurate to age of recruitment. It was assumed, therefore, that growth rather than recruitment was the main contributor to biomass production. For some of the stocks assessed, available time-series data of CPUE comprise a gradual decline across the time period studied. The Study Group was aware that the results from production models in these circumstances (the so called 'one way trip') can be unreliable.

VPA analysis

This method has been used in the assessment of red (blackspot) seabream (*Pagellus bogaraveo*). The Lowesoft VPA package was used and extended survivors analysis (XSA) was used for tuning.

Stock reduction models

Stock reduction analysis is a developed form of a delay-difference model (Quinn and Deriso, 1999). The method uses biologically meaningful parameters and information for time delays due to growth and recruitment to predict the basic biomass dynamics of the populations without requiring information on age structure. Thus it can be considered to be a conceptual hybrid between dynamic surplus production and full age based models (Hilborn and Walters, 1992). A full description of the general approach can be found in Kimura and Tagart (1982), Kimura *et al* (1984) and Kimura (1985 and 1988).

The stock reduction model used is part of program suite (PMOD) developed by Francis (1992, 1993) and Francis *et al* (1995). Simple deterministic and enhanced stochastic models are included, but given the paucity of the available data it was decided to use the former. The method requires time-series data of annual catches, one or more abundance index and a range of biological parameters. Given the uncertainty in the biological parameters for deep-water species in the

ICES area, the model was run for alternative parameter scenarios to test the sensitivity of the results to these values. A Beverton and Holt stock and recruitment relationship with a steepness of 0.75 was used throughout (Francis, 1993).

The method provides an estimate of virgin biomass (B_0) and current biomass from which a depletion ratio can be calculated. This ratio is then used to evaluate the status of stocks in relation to precautionary and limit biomass reference points, which for deep-water stocks in the ICES area are 50% and 20% of virgin exploitable biomass, respectively (ICES, 1998).

The stock reduction model developed by Francis also provides an estimate of the annual mean catch that can be taken, consistent with a 10% probability of spawning stock biomass falling below 20% of virgin SSB. In New Zealand and Australian fisheries this catch is termed the maximum constant yield (MCY). Given that age of recruitment and age of maturity are reasonably similar for some species e.g. orange roughy, 20% of virgin SSB can be considered to be broadly equivalent to 20% of virgin exploitable biomass. It should be possible, therefore, to estimate a sustainable constant catch broadly consistent with a high probability of maintaining exploitable biomass above the limit reference level for deep-water stocks in the ICES area.

Ad hoc methods

Where *ad hoc* methods have been used these are described in the relevant species assessment sections.

3.2 Software

The main assessment software used at the Study Group was CEDA: Catch Effort data analysis, produced by MRAG Ltd, 27 Campden Street, London W8 7EP, UK.

4 PRECAUTIONARY APPROACH

Deep-water fishes continue to receive increased attention from national and international management authorities, conventions and non-governmental organisations. Increasing fishing effort on species many of which are generally considered to be long-lived, slow growing, with low reproductive potential for replacement is a potentially serious threat to deep-water fish stocks in many parts of the world. Moreover, for most stocks the effect of increased levels of fishing is difficult to determine because of a lack of scientific data. However, this is now no longer justification for not introducing management measures. Article 7.5 of the FAO Code of Conduct states that:

“States should apply the precautionary approach widely to conservation, management and exploitation of living aquatic resources in order to protect them and preserve the aquatic environment. The absence of adequate scientific information should not be used as a reason for postponing or failing to take conservation or management measures. In implementing the precautionary approach, States should take into account, inter alia, uncertainties relating to the size and productivity of the stocks, reference points, stock condition in relation to such reference points, levels and distribution of fishing mortality and the impact of fishing activities, including discards on non-target and associated and dependent species as well as environmental and socio-economic conditions. States and subregional or regional fisheries management organisations and arrangements should, on the basis of the best scientific evidence available, inter alia, determine stock specific limit reference points and, at the same time, the action to be taken if they are exceeded.”

The urgent need to implement the precautionary approach to manage deep-water fish stocks is exacerbated by the low survival rate of discarded species and escapees. Thus, increasing fishing effort will affect deep-water fish assemblages in general and not just species of commercial importance.

With regard to suitable biological reference points for deep-water stocks, given that the basic data available for these stocks are still comparatively sparse the Group, at its 2000 meeting, felt that the proposed PA limit and reference points for data-poor situations by the ICES Study Group on the Precautionary Approach to Fishery Management (ICES C.M. 1997/Assess:7) were reasonable:

$$F_{lim} = F_{35} \% SPR$$

$$F_{pa} = M$$

$$U_{lim} = 0.2 * U_{max} \text{ (may be a smoothed abundance index)}$$

$$U_{pa} = 0.5 * U_{max}$$

Where U is the index of exploitable biomass (notation used for deep-water stocks by ACFM in May 1998).

In its 2000 report the Group commented on the state of stocks in relation to these reference points whenever possible. The ACFM subsequently adopted the U_{lim} and U_{pa} reference points for all deep water stocks for which advice was provided (ICES, 2001b, ICES Coop. Res. Rep. 246(3)).

It was noted from the 2001 report of the ICES Study Group on the Precautionary Approach to Fishery Management that the SGPA was unable to offer any alternative to these proposals as a first approach to setting precautionary reference points when appropriate data are available”. Therefore, the Group continued to use where possible the measures above as implemented previously.

The Group was informed that another meeting of the ICES Study Group on the Precautionary Approach to Fishery Management was held in March, 2002 and that it had investigated alternative measures for certain deepwater stocks. However, the report from the SGPA is not yet available to allow the Group to evaluate the appropriateness of any potentially new measures suggested.

Table 5.1 Stock summary for species considered by the ICES Working Group on the Biology and Assessment of Deep-sea Fisheries Resources. The Working Group acknowledges that stock units are not well defined for the above species.

Species	ICES Sub-area/division	Assessment type and final year of data	Salient features	State of stock	Concerns / comments
Ling (<i>Molva molva</i>)	IIa,IVa,V,VI and VII	Catch curves in late 90s and CPUE. Main CPUE series truncated in mid-90s. 2001	Average Z very high in late 90s. Historical CPUE data show strong decline in most areas.	Stock declining in Va and believed to remain very low in other areas and is < Upa and possibly close to Ulim, as stated in 2000.	Length and age data series available but not provided to the WG.
Blue ling (<i>Molva dypterygia</i>)	I-XII and XIV	Assessments unreliable. CPUE only. 2001.	Strong decline in CPUE	Stock declining. Considered to be below Ulim	Fishing on spawning concentrations implies that CPUE trend may underestimate the stock trends and should be treated with caution.
Tusk (<i>Brosme brosme</i>)	IIa,IVa,V,VI	Catch curves in late 90s and CPUE. Main CPUE series truncated in mid 90s. 2001	Historical CPUE data show strong decline in most areas.	Stock below Upa in Va and believed to be at a very low level in other areas.	Length and age data series still inadequate for analytical assessment.
Greater Silver Smelt (<i>Argentina silas</i>)	Mainly IIa,III,V,VI,VII	No recent assessment. 2001		Uncertain	Overall landings have been increasing in recent years, particularly in areas VI & VII.
Orange Roughy (<i>Hoplostethus atlanticus</i>)	Mainly V, VI, VII, X and XII	Assessments unreliable. CPUE data only. 2001	Stock heavily depleted in VI. Situation in VII less clear. CPUE data stable but reflects sequential discovery of new aggregations.	Stock biomass in VI depleted. Situation on VII less clear	CPUE trends may only reflect fish density on successively exploited aggregations. Recent high landings in VII are unlikely to be sustainable.
Roundnose Grenadier (<i>Coryphaenoides rupestris</i>)	III,V, VI VII and XII. Data mainly from V,VI & VII	Assessment unreliable. CPUE data only. 2001	CPUE declining until 1999 and then increased. Increase not believed to reflect stock abundance.	Probably below Upa.	Requirement for age data. Number of large fish declining. Discard data should be collected.
Black Scabbardfish (<i>Aphanopus carbo</i>)	Mainly V,VI,VII,VIII and IX	Assessment unreliable. CPUE data only. 2001	Consistent decline in CPUE in V, VI and VII but sharp increase in 2001 for VI and VII. CPUE in VIII & IX stable.	Uncertain in V VI VII and XII but probably below Upa. Situation in VIII & IX stable.	Stock structure unknown.
Golden Eye Perch (<i>Beryx splendens</i>)	Mainly X	No information		Unknown	Concern about sequential depletion and reporting from international waters.
Red (blackspot) Seabream (<i>Pagellus bogaraveo</i>)	Mainly in X, some in IX and residual in VI, VII, VIII	VPA assessment attempted but results unreliable. 2001.		Uncertain in IX and X. Historical trend of landings for other areas indicates a continued depleted state.	
Greater forkbeard (<i>Phycis blennoides</i>)	All areas but mainly VI, VII, VIII and IX	No assessment	CPUE data not used because landings statistics may include landings of Morids and concerns about CPUE of bycatch species.	Unknown	Mainly bycatch
Deepwater sharks Mainly <i>Centroscymnus coelolepis</i> and <i>CentropHORUS squamosus</i>	Mainly in VI, VII, VIII, IX, X and XII	No assessment. CPUE data available for <i>C. squamosus</i> & <i>C. coelolepis</i> 2001	Overall decline in CPUE in VI but sharp increase in 2001. CPUE in V & VII declining particularly in VI	Uncertain. Believed to be low in V, VI and VII	Short CPUE time series. Need for species separated data

6 GENERAL

6.1 Description of fisheries by nation

6.1.1 Faroe Islands

Longline fisheries for tusk (*Brosme brosme*), ling (*Molva molva*) and blueling (*Molva dypterygia*) have been well established for many years. In the late 1970s the trawl fishery extended into deeper water targeting redfish (*Sebastes spp.*) and blue ling and to a lesser degree black scabbardfish (*Aphanopus carbo*) and roundnose grenadier (*Coryphaenoides rupestris*). In the 1990s a gill net fishery directed at monkfish (*Lophius piscatorius*) and Greenland halibut (*Reinhardtius hippoglossoides*) developed and more recently a directed longline fishery on deepwater sharks (*Centroscymnus coelolepis* and *Centrophorus squamosus*) was initiated. A trawl fishery for argentine (*Argentina silus*) has been expanded rapidly in recent years. Most fisheries take place inside the Faroese zone, but from time to time the fishery has been expanded to the Hatton Bank/Rockall area, eg. targeting blue ling during spawning season.

In the early 1990s one trawler fished continuously on Hatton Bank for 5-6 years. During the first quarter of the year the vessel was targeting blue ling. In the second quarter black scabbardfish became the most important species and later in the year roundnose grenadier had increasing importance. The trawler has now changed to fishing on the shelf.

Following a special exploratory trawl fishing programme initiated in 1992 aimed at orange roughy (*Hoplostethus atlanticus*), one trawler has been regularly fishing on the Mid-Atlantic Ridge. The fishery is directed towards orange roughy most of the time, but sometimes other deep-sea species as black scabbardfish, roundnose grenadier and deep-water sharks are taken.

6.1.2 France

Deep-water fisheries for typical deep-water species (*Coryphaenoides rupestris*, *Centrophorus squamosus* and *Centroscymnus coelolepis*-siki-, *Aphanopus carbo*, *Hoplostethus atlanticus*).

The landings of these deep-water fishes are mainly land in three ports: Boulogne-sur-Mer, Concarneau and Lorient. Only bottom trawlers are involved in this fishery. In Boulogne-sur-Mer, the 7 high seas bottom trawlers involved in the fishery are large trawlers (50 to 55 meters long). In Lorient and Concarneau, the main part of the fleet is composed of medium high seas trawlers (30 vessels from 32 to 40 m long). The other part is composed with largest high seas trawlers (8 vessels). About 20 trawlers regularly landed their fish in UK and the catch are return by lorries in France to be sell in the French fish auction market. There is no cargo anymore that carried the catches to France. It seems that this number of units will decline in near future.

Fishery for other species of continental slope (*Molva molva*, *Beryx splendens*, *Phycis blennoides*)

In France, these species are not considered as from the deep fishery as they distribute in the upper continental slope contrary to the previous species that distribute in the mid slope. The ports in which typical deep-water species are landed, account for two third of the catch of ling (*Molva molva*) and in those ports this species is also landed by artisanal trawlers (17-28 meters long) that are used to work in the shelf in sub-areas VII and XII. In the same way, *Beryx splendens* and *Phycis blennoides* are landed both by the deep-water fleet and shelf trawlers.

French CPUE series

The French catch and effort data used in stock assessments are extracted from the official national database owned by the Directorate of Fisheries and Aquaculture. In 1999, the configuration of the database has been altered. This change has adversely affected the extraction of the most recent years of data, until recently. Fisheries data for period 1999-2001 became available to the Working Group only a few weeks before it started. The format and quality of these data is thought to be coherent along the whole time series. However, the spatial allocation of fishing time could not be made available for period 1999-2001, as a result of the late data delivery. Therefore, it was not possible this year to derive the directed fishing effort by species as in SGDEEP 2000. In WGDEEP 2002, the fishing effort of the French tuning fleets has been equated to the total annual trawling time, and this estimate was used to calculate the relevant CPUE time series. It has then been investigated the extent to which the new way of calculating fishing effort could affect the CPUE and stock impressions as assessed in SGDEEP 2000. A comprehensive spatially distributed catch and effort data set will be made available to the next meeting, so that the procedure of deriving directed fishing effort and CPUE for the French fleets as applied in 2000 may be resumed.

6.1.3 Germany

There have been no new developments since the 1998 report.

6.1.4 Greenland

Traditionally small by-catches have been reported of roundnose grenadier from the Greenland fisheries for Greenland halibut in ICES Division XIVb.

6.1.5 Iceland

Tusk, ling and blue ling remains the most important “deep-sea species” in Icelandic waters. In 1999 - 2001, about 120 vessels were engaged in these fisheries with registered catches from less than 100 kg to nearly 1000 tonnes. In 2001 around 4500 tonnes of deep water species were caught in bottom trawl, whereof 3000 were greater silver smelt. This is a reduction of 40% from 2000 landings. The reduction is mostly due to the decrease in the greater silver smelt fishery, but also due to reduction in the landings of tusk. By longline, nearly 4500 tonnes were caught, mostly tusk, but also blue ling and ling. Compared with 2000, this is a reduction of about 35%. About 1200 tonnes were fished with other gear types. Landings of deep-sea species in 2001 were almost exclusively taken within the Icelandic EEZ.

Discarding is prohibited on Icelandic vessels and information on discard is not available. A review of the deep-water fisheries of Iceland has been published by Magnusson (1998) and in Gordon (1999).

6.1.6 Norway

Longline fisheries

The longline fishery for ling (*Molva molva*) and tusk (*Brosme brosme*) remains the most important aimed deep-sea fishery in Norway (e.g. Bergstad and Hareide 1996). Around 60 vessels longer than 70 feet are engaged in these fisheries which are mainly conducted in ICES Divisions and Sub-areas IIa, IVa, V, VI, VII, and XIV. The longliner fleet also has other often preferred target species for parts of the year, primarily northeast Arctic cod in area I and IIa. A time series of effort data on the fisheries in the period 1974–1996, i.e., number of vessels, weeks at sea, distribution of effort by species and Norwegian Directorate of Fisheries statistical areas, were given in the 1998 report. The number of vessels declined until 1994, but the number increased again in the most recent years. Due to technological advances, effort in terms of number of hooks increased throughout the series despite the decline in number of vessels and number of weeks engaged in the fishery (see Hareide and Godø 1996; Bergstad and Hareide 1996; Magnússon *et al.* 1997a).

The same vessels may also temporarily target other species such as redfish (*Sebastes* sp.) and Greenland halibut (*Reinhardtius hippoglossoides*). In recent years a longline fishery developed off southeastern Greenland at depths down to 1500 m. The target species is Greenland halibut, but probably as much as 30 % of the by-catch is roughhead grenadier (*Macrourus berglax*). The area of this fishery has expanded to eastern and western slopes of the Reykjanes Ridge south of Iceland.

In 1996, a dropline (and gillnet) fishery targeting “giant redfish” (*Sebastes marinus*) also developed on the Reykjanes Ridge (Sub-areas XII and Division XIVb). Detailed data on this fishery and estimated catches were presented in the final report of the EC FAIR project (Gordon, 1999). In 1996, 9 vessels were engaged in the fishery for a few weeks (number of active fishing days was 399). Tusk (*Brosme brosme*) and Atlantic halibut (*Hippoglossus hippoglossus*) were significant landed by-catches. By-catches of the deep-water shark *Centroscyllium fabricii* and some other species were discarded. In 1997, the number of vessels participating dropped to 7 and the effort in terms of fishing days declined by 77%. The activity declined further to low levels in 1998 and 1999, suggesting that this fishery was not viable at the level observed in 1996.

In 1999-2001, some exploratory longlining was carried out on the slope of the Hatton Bank and to a limited extent on the Mid-Atlantic Ridge (WD by Hareide *et al.* 2002 and references therein).

Trawl fisheries

The relevant trawl fisheries were described in previous reports (ICES C.M. 1994/Assess:4; ICES C.M. 1996/ Assess:8). There have been no major changes in the recent years.

7 LING (*MOLVA MOLVA*)

7.1 Catch Trends

Landings by Sub-area or Division for the period 1988-2001 are given in Table 7.1. The 2000 and 2001 data are provisional.

The major fisheries in Division IIa are the Norwegian longline and gillnet fisheries, but there are also by-catches by other gears, i.e., trawls and handline. The total landings of almost about 9,000 t in 1998 was the highest in the period 1988-2001, and in recent years there has been a decline. The preliminary landing for 2001 is 4,851 t. Of the Norwegian landings in 2001, 49.8% were taken by longline and 44.9% by gillnet. Landings in areas I, IIb, and III remained small and are mostly by-catches.

In Division IVa the total landings has varied between near 8,000 and 10,000 t since 1998, at a somewhat lower level than previously. The major aimed ling fishery in IVa is the Norwegian longline fishery conducted around Shetland and in the Norwegian Deep, and of the total Norwegian landings in 2001 75.5% were taken by longline, and 16.9% by gillnet and the remainder by trawl. The bulk of landings from other countries were taken by trawl as by-catches in other fisheries, and the landings from the United Kingdom (Scotland) are the most substantial. The comparatively low landings from the central and southern North Sea (IVb,c), are by-catches in various other fisheries.

In Divisions Va the landings decreased from 5,600-5,800 t in the late 1980s to about 4,000 t in recent years and most are by-catches in fisheries for other species. Of the Icelandic landings in 2000 and 2001, about 45% were taken by longlines, and 20-30% from each of gillnet and trawls. Landings in Division Vb1 and Vb2, which are mainly Faroese and Norwegian longline catches, appeared to increase in the late 1990s, but preliminary figures for 2000 and 2001 indicates a decline to a somewhat lower level more equal to the level in the late 1980s and early and mid-1990s.

In Division VIa the statistics are incomplete for the period 1989-1993, and no conclusions on trends can be drawn. In the period 1994-2001 when the data are complete, there was no trend. The major fisheries are the Norwegian aimed longline fisheries, and trawl fisheries by the United Kingdom (Scotland) and France which primarily take ling as by-catch. The Norwegian landings declined substantially in 2001 compared with earlier years. In Division VIb landings declined in the period 1994-1997, primarily due to reduced Norwegian contributions, but has since varied without trend between approximately 800 and 1,900 t.

In Sub-area VII the Divisions b, c, and g-k provide most of the landings of ling. There appears to have been an increasing trend in the 1990s and landings in the period 1995-1997 were above 10 000 t. In 1998 the total landing was 11,107 t. Subsequently there has been a decline in most areas, and the preliminary landing figure for 2001 is only 5,386 t. Norwegian landings, and some of Irish and Spanish are from longline fisheries, whereas other landings are primarily by-catches in trawl fisheries. Data split by gear type was not available for all countries, but the bulk of the total landings (at least 60-70%) are taken by trawl in these areas. Some data on discards of ling representing the Basque trawler metiers were provided in a working document by Lucio *et al.* (2002), but similar data were not available for other fisheries in the area.

In Sub-area VII landings appear to have declined in the most recent years, and all are by-catches in various fisheries.

7.2 Stocks

No new information on stock separation was available. Relevant data were presented and discussed in reports of previous Norwegian and Nordic projects and summarised in the 1998 report of the study group (ICES C.M. 1998/ACFM:12). There is currently no evidence of genetically distinct populations within the ICES area. However, ling at widely separated fishing grounds may still be sufficiently isolated to be considered management units, i.e., stocks, between which exchange of individuals is limited and has little effect on the structure and dynamics of each unit. It was suggested that Iceland (Va), the Norwegian Coast (II), and the Faroes and Faroe Bank (Vb) have separate stocks, but that the existence of distinguishable stocks along the continental shelf west and north of the British Isles and the northern North Sea (Sub-areas IV, VI, VII and VIII) is less probable.

7.3 Catch-effort data

The extensive Norwegian longliner CPUE data based on skipper's logbooks presented in the 1996 report were not updated after 1994. In the 1998 report (Table 6.5 of ICES C.M. 1998/ACFM:12), effort data were given for the period 1974-1996 based on official statistics, but the series has not been extended.

Revised commercial CPUE data for Division Vb were available from Faroese longliners for the period 1986-1999 (Table 7.2, of ICES C.M. 2000/ACFM:08). Updated data were not available for the more recent years.

Effort and CPUE from Icelandic longliners in the period 1994-2001 were presented (Sigurdsson 2002) and are given in Table 7.2. A time series for a CPUE index from the Icelandic groundfish survey is shown in Figure 7.1 for the period 1985-2001.

CPUE data for Basque trawlers and longliners fishing in Sub-area VI and VII in the years 1994-2001 were available (Fig. 7.2).

CPUE from the French trawl fishery in division Vb and sub-areas VI and VII were provided (Figure 7.3). This CPUE was computed from the reference deep water fleet (see Ch. 6.1.2). This CPUE is a basic ratio of the total catch per area (in tonnes) to the total fishing effort in hours. As ling is only a bycatch species for this deep water fleet, this CPUE should be regarded with caution. It is advisable to consider it as a simple indication until evidence of its reliability has been provided. New CPUE series will be computed under the TECTAC project (Ch. 2.3.6).

An abundance index of ling in the annual French trawling cruise in the bay of Biscay was presented (Figure 7.4). The index presented is an average number of ling caught per haul. It should be noted that this species is only caught in small numbers in this cruise and the index is only preliminary. Improvement and assessment of reliability of abundance indices from this survey are on going.

Data on catch and corresponding effort for the Danish fleets taking Ling in IIIA and IVA are available for the period 1992-2001 from the logbooks, see (Table 7.3). There seem to be no clear trend in CPUEs in both areas for the period. However, since Ling is a by-catch and the catches are small, one should be cautious using these CPUEs alone as indicators for the stock in this area.

7.4 Length Distribution, Age Composition, Mean Weight and Maturity at Age

Data available from different countries and Divisions were indicated in Tables 6.3.1-6.3.6 of ICES C.M. 1996/Assess:8 and in ICES C.M. 1998/ACFM:12. Overviews of Norwegian samples from 1995 and earlier were given by Bergstad and Hareide (1996). Very little data were collected by Norway after 1995.

Length distributions of Icelandic catches in Division Va for the period 1995-2001 are shown in Figure 7.5. Figure 7.6 shows length distributions from the Icelandic groundfish survey representing the period 1985-2001. The length distributions suggest no change in the size composition with time.

Length frequency from the Irish longline survey in Sub-area VII for 2000 is shown in Figure 7.7.

7.5 Biological parameters

Considerable information on biological parameters from many parts of the distribution area were presented in two relatively recent project reports, i.e., Bergstad and Hareide (1996) and Magnússon *et al.* (1997a), and Bergstad *et al.* (1998). No new data were presented to the Working Group this year. The following text table is a compilation of available data, extracted from the report of WGDEEP in 2001 (ICES C.M. 2001/ACFM: 23):

Variable	Value	Source/comment
Longevity (years)	Approx. 20	Bergstad and Hareide 1996, Magnússon <i>et al.</i> 1997
Growth rate, K	No data	Growth curves available in Bergstad and Hareide 1996.
Natural mortality, M	0.2-0.3	Based on review by SGDEEP 2000.
Fecundity (absolute)	millions	No exact data available.
Length at first maturity	60-75 cm	Magnússon <i>et al.</i> 1997
Age at first maturity	5-7 years	Magnússon <i>et al.</i> 1997

7.6 Assessment: CPUE analyses and mortality estimates

No new assessments could be conducted in 2002 primarily due to the lack of sufficient CPUE data from the main fisheries. Updated data were presented from Iceland (Va), the Spanish fleets fishing in VI and VII, and the French and Danish trawlers. With the exception of the Va series from Iceland, these do not represent the major fisheries for ling.

In addition, no new data were available to estimate mortality despite that in previous assessments it was estimated to have been high during the last decade. The last stock status evaluation was presented in 2000 (ICES C.M. 2000/ACFM:08).

The Icelandic CPUE series from commercial longliners show no obvious trend, but the survey series suggest a decline in abundance. It is, however, a concern that the survey does not sample the entire depth range of the species.

Spanish CPUE data from Basque trawlers and longliners were available for the period 1994–2001 (Figure 7.3). The effort unit is number of trips. The number of longline vessels included in the analysis is very low and the trawler data, primarily from vessels targeting hake, should be considered somewhat more reliable. There was a rather consistent decline in the trawler CPUE of ling in Sub-area VI and VII in the period 1994-1998, and an apparent increase in 1999-2000, but overall the series show no clear trend. The longliner series shows an unexplained increase in 1998-1999, but then a decline.

7.7 Comments on Assessment

It is still not possible to make analytical or CPUE based assessments for the ling stocks due to lack of good time series of data from the major fisheries. The Working Group is of the opinion that further improvement in the recording of effort and catch data from all fleets and areas should be encouraged, since CPUE analyses was previously used with some success to provide an index of abundance and as basis of production analyses.

7.8 Management considerations

This issue was considered at some length in 2000 (ICES CM 2000/ACFM:08), and due to the lack of new assessment results, very little can be added.

The updated CPUE series for the Icelandic longline fishery in Va shows no trend in the period 1994-2001. The series from the groundfish survey, for the years 1985 to 2001, shows however a rather clear declining trend, and indices for 2000 and 2001 are the lowest in the series. The commercial effort statistics may not fully account for changes in efficiency. Considered together, these series may be interpreted as showing a declining abundance of ling being compensated for by enhanced efficiency in the commercial fishery.

No new data were available for evaluating stock status in relation to reference points. There is, however, no evidence to suggest that the state of the ling stocks has changed since the assessments in 1998 and 2000. Available data suggest that also the ling stock in Va is declining, but no statement can be made of the state of the stock in relation to reference points at this stage.

Table 7.1. Ling (*Molva molva*). Working Group estimates of landings (tonnes).**LING I**

Year	Norway	Iceland	Total
1996	136		136
1997	31		31
1998	123		123
1999	64		64
2000*	68	1	69
2001*	65	1	66

*Preliminary

LING IIa

Year	Faroes	France	Germany	Norway	E & W	Scotland	Total
1988	3	29	10	6,070	4	3	6,119
1989	2	19	11	7,326	10	-	7,368
1990	14	20	17	7,549	25	3	7,628
1991	17	12	5	7,755	4	+	7,793
1992	3	9	6	6,495	8	+	6,521
1993	-	9	13	7,032	39	-	7,093
1994	101	n/a	9	6,169	30	-	6,309
1995	14	6	8	5,921	3	2	5,954
1996	0	2	17	6,059	2	3	6,083
1997	0	15	7	5,343	6	2	5,373
1998		13	6	9,049	3	1	9,072
1999		11	7	7,557	2	4	7,581
2000*		9	39	5,836	5	2	5,891
2001*		9	34	4,805	0	3	4,851

*Preliminary

LING IIb

Year	Norway	E & W	Total
1988		7	7
1989		-	
1990		-	
1991		-	
1992		-	
1993		-	
1994		13	13
1995		-	
1996	127	-	127
1997	5	-	5
1998	5	+	5
1999	6		6
2000*	4	-	4
2001*	33	-	33

*Preliminary

Table 7.1. continued

LING III

Year	Belgium	Denmark	Germany	Norway	Sweden	E & W	Total
1988	2	165	-	135	29	-	331
1989	1	246	-	140	35	-	422
1990	4	375	3	131	30	-	543
1991	1	278	-	161	44	-	484
1992	4	325	-	120	100	-	549
1993	3	343	-	150	131	15	642
1994	2	239	+	116	112	-	469
1995	4	212	-	113	83	-	412
1996		212	1	124	65	-	402
1997		159	+	105	47	-	311
1998		103	-	111	-	-	214
1999		101	-	115	-	-	216
2000*		101	+	96	31		228
2001*		125	+	102	25		252

*Preliminary

LING IVa

Year	Belgium	Denmark	Faroes	France	Germany	Neth.	Norway	Sweden	E&W	N.I.	Scot.	Total
1988	3	408	13	1,143	262	4	6,473	5	55	1	2,856	11,223
1989	1	578	3	751	217	16	7,239	29	136	14	2,693	11,677
1990	1	610	9	655	241	-	6,290	13	213	-	1,995	10,027
1991	4	609	6	847	223	-	5,799	24	197	+	2,260	9,969
1992	9	623	2	414	200	-	5,945	28	330	4	3,208	10,763
1993	9	630	14	395	726	-	6,522	13	363	-	4,138	12,810
1994	20	530	25	n/a	770	-	5,355	3	148	+	4,645	11,496
1995	17	407	51	290	425	-	6,148	5	181		5,517	13,041
1996	8	514	25	241	448	-	6,622	4	193		4,650	12,705
1997	3	643	6	206	320		4,715	5	242		5,175	11,315
1998	8	558	19	175	176		7,069	-	125		5,501	13,631
1999	16	596	n.a.	293	141		5,077		240		3,447	9,810
2000*	20	538	2	146	103		4,780	7	74		3,576	9,246
2001*		702	1	115	54		3,613	6	60		3,290	7,841

*Preliminary. ⁽¹⁾ Includes IVb 1988-1993.

LING IVb,c

Year	Belgium	Denmark	France	Sweden	Norway	E & W	Scotland	Germany	Total
1988					100	173	106	-	379
1989					43	236	108	-	387
1990					59	268	128	-	455
1991					51	274	165	-	490
1992		261			56	392	133	-	842
1993		263			26	412	96	-	797
1994		177			42	40	64	-	323
1995		161			39	301	135	23	659
1996		986			100	187	106	45	1424
1997	33	166	1	9	57	215	170	48	699
1998	47	164	5		129	128	136	18	627
1999	35	138	-		51	106	106	10	446
2000*	59	101	0	8	45	77	90	4	384
2001*	47	81	0	3	23	62	60	6	282

* Preliminary

Table 7.1 continued

LING Va

Year	Belgium	Faroes	Germany	Iceland	Norway	E & W	Scotland	Total
1988	134	619	-	5,098	10			5,861
1989	95	614	-	4,898	5			5,612
1990	42	399	-	5,157	-			5,598
1991	69	530	-	5,206	-			5,805
1992	34	526	-	4,556	-			5,116
1993	20	501	-	4,333				4,854
1994	3	548	+	4,053				4,604
1995		463	+	3,729	-			4,192
1996		358		3,670	20	12		4,060
1997		299		3,634	0	-		3,933
1998		699		3,603	-	-		4,302
1999		542	+	3,980	120	4	1	4,647
2000*		452	+	3,221	67	3	+	3,743
2001*		333	2	2,864	117	4	+	3,320

*Preliminary.

LING Vb1

Year	Denmark	Faroes	France ⁽²⁾	Germany	Norway	E&W ⁽¹⁾	Scotland ⁽¹⁾	Total
1988	42	1,383	53	4	884	1	5	2,372
1989	-	1,498	44	2	1,415	-	3	2,962
1990	-	1,575	36	1	1,441	+	9	3,062
1991	-	1,828	37	2	1,594	-	4	3,465
1992	-	1,218	3	+	1,153	15	11	2,400
1993	-	1,242	5	1	921	62	11	2,242
1994	-	1,541	6	13	1,047	30	20	2,657
1995		2,789	4	13	446	2	32	3,286
1996		2,672			1,284	12	28	3,996
1997		3,224	7		1,428	34	40	4,733
1998		2,422	6		1,452	4	145	4,029
1999		2,446	22	3	2,034	0	71	4,576
2000*		1,942	9	1	1,305	2	61	3,320
2001*		2,206	17	3	1,496	0	99	3,821

*Preliminary. ⁽¹⁾ Includes Vb₂. ⁽²⁾ Includes Vb₂ and Va. ⁽³⁾ Reported as Vb.

LING Vb2

Year	Faroes	Norway	Total
1988	832	1,284	2,116
1989	362	1,328	1,690
1990	162	633	795
1991	492	555	1,047
1992	577	637	1,214
1993	282	332	614
1994	479	486	965
1995	281	503	784
1996	102	798	900
1997	526	398	924
1998	511	819	1,330
1999	164	498	662
2000*		399	399
2001*	182	497	679

*Preliminary. ⁽¹⁾ Included in Vb₁.

Table 7.1. continued

LING VIa

Year	Belgiu	Denmar	Faroes	France	German	Ireland	Norway	Spain ⁽²⁾	E&W	IOM	N.I.	Scot.	Total
1988	4	+	-	5,381	6	196	3,392	3575	1,075	-	53	874	14,556
1989	6	1	6	3,417	11	138	3,858		307	+	6	881	8,631
1990	-	+	8	2,568	1	41	3,263		111	-	2	736	6,730
1991	3	+	3	1,777	2	57	2,029		260	-	10	654	4,795
1992	-	1	-	1,297	2	38	2,305		259	+	6	680	4,588
1993	+	+	-	1,513	92	171	1937		442	-	13	1,133	5,301
1994	1	1		1713	134	133	2034	1027	551	-	10	1,126	6,730
1995	-	2	0	1970	130	108	3,156	927	560	n/a		1994	8,847
1996			0	1762	370	106	2809	1064	269			2197	8,577
1997			0	1,631	135	113	2229	37	151			2,450	6,746
1998				1,531	9	72	2,910	292	154			2,394	7,362
1999				941	4	73	2,997	468	152			2,264	6,899
2000*	+	+		717	3	75	2,956	359	143			2,287	6,240
2001*				720	3	70	1,869	129	106			2,179	5,076

*Preliminary. ⁽¹⁾ Includes VIb until 1996 ⁽²⁾ Includes minor landings from VIb.

LING VIb

Year	Faroes	France ⁽²⁾	Germany	Ireland	Norway	Spain ⁽³⁾	E & W	N.I.	Scotland	Russia	Total
1988	196		-	-	1,253		93	-	223		1,765
1989	17		-	-	3,616		26	-	84		3,743
1990	3		-	26	1,315		10	+	151		1,505
1991	-		-	31	2,489		29	2	111		2,662
1992	35		+	23	1,713		28	2	90		1,891
1993	4		+	60	1179		43	4	232		1,522
1994	104		-	44	2116		52	4	220		2,540
1995	66		+	57	1,308		84		123		1,638
1996	0		124	70	679		150		101		1,124
1997	0		46	29	504		103		132		814
1998		1	10	44	944		71		324		1,394
1999		26	25	41	498		86		499		1,175
2000*	+	18	31	19	1,172		157		475	7	1,879
2001*		16	3	18	328		116		307		788

*Preliminary. ⁽¹⁾ Includes XII. ⁽²⁾ Until 1966 included in VIa. ⁽³⁾ Included in Ling VIa.

LING VII

Year	France	Total
1988	5,057	5,057
1989	5,261	5,261
1990	4,575	4,575
1991	3,977	3,977
1992	2,552	2,552
1993	2,294	2,294
1994	2,185	2,185
1995	⁽¹⁾	
1996	⁽¹⁾	
1997	⁽¹⁾	
1998	⁽¹⁾	
1999	⁽¹⁾	
2000	⁽¹⁾	
2001	⁽¹⁾	

⁽¹⁾ Reported by Division

Table 7.1. continued

LING VIIa

Year	Belgium	France	Ireland	E & W	IOM	N.I.	Scotland	Total
1988	14	⁽¹⁾	100	49	-	38	10	211
1989	10	⁽¹⁾	138	112	1	43	7	311
1990	11	⁽¹⁾	8	63	1	59	27	169
1991	4	⁽¹⁾	10	31	2	60	18	125
1992	4	⁽¹⁾	7	43	1	40	10	105
1993	10	⁽¹⁾	51	81	2	60	15	219
1994	8	⁽¹⁾	136	46	2	76	16	284
1995	12	9	143	106	1	⁽²⁾	34	305
1996	11	6	147	29	-	⁽²⁾	17	210
1997	8	6	179	59	2	⁽²⁾	10	264
1998	7	7	89	69	1	⁽²⁾	25	198
1999	7	3	32	29		⁽²⁾	13	84
2000*	3	2	18	25			25	73
2001*		3	33	20			31	87

*Preliminary. ⁽¹⁾ French catches in VII not split into divisions, see Ling VII. ⁽²⁾ Included with UK (EW)

LING VIIb,c

Year	France	Germany	Ireland	Norway	Spain ⁽³⁾	E & W	N.I.	Scotland	Total
1988	⁽¹⁾	-	50	57		750	-	8	865
1989	⁽¹⁾	+	43	368		161	-	5	577
1990	⁽¹⁾	-	51	463		133	-	31	678
1991	⁽¹⁾	-	62	326		294	8	59	749
1992	⁽¹⁾	-	44	610		485	4	143	1,286
1993	⁽¹⁾	97	224	145		550	9	409	1,434
1994	⁽¹⁾	98	225	306		530	2	434	1,595
1995	78	161	465	295		630	⁽²⁾	315	1,944
1996	57	234	283	168		1117	⁽²⁾	342	2,201
1997	65	252	184	418		635	⁽²⁾	226	1,780
1998	32	1	190	89		393		329	1,034
1999	50	4	377	288		488		159	1,366
2000*	116	21	401	170		327		140	1,175
2001*	71	2	413	515		94		122	1,217

*Preliminary. ⁽¹⁾ See Ling VII. ⁽²⁾ Included with UK (EW). ⁽³⁾ Included with VIIg-k.

LING VIIId,e

Year	Belgium	Denmark	France	Ireland	E & W	Scotland	Ch. Islands	Total
1988	36	+	⁽¹⁾	-	743	-		779
1989	52	-	⁽¹⁾	-	644	4		700
1990	31	-	⁽¹⁾	22	743	3		799
1991	7	-	⁽¹⁾	25	647	1		680
1992	10	+	⁽¹⁾	16	493	+		519
1993	15	-	⁽¹⁾	-	421	+		436
1994	14	+	⁽¹⁾	-	437	0		451
1995	10	-	885	2	492	0		1,389
1996	15		960		499	3		1,477
1997	12		1,049	1	372	1	37	1,472
1998	10		953		510	1	26	1,500
1999	7		538	-	507	1		1,053
2000*	5		446	1	372	+	14	837
2001*			384	-	399	-		783

*Preliminary. ⁽¹⁾ See Ling VII.

LING VIII

Year	Belgium	France (1)	Ireland	E & W	Scotland	Total
1988	77	(1)	-	367	-	444
1989	42	(1)	-	265	3	310
1990	23	(1)	3	207	-	233
1991	34	(1)	5	259	4	302
1992	9	(1)	1	127	-	137
1993	8	(1)	-	215	+	223
1994	21	(1)	-	379	-	400
1995	36	110	-	456	0	602
1996	40	121	-	238	0	399
1997	30	204	-	313		547
1998	29	204	-	328		561
1999	16	108	-	188		312
2000*	15	90	1	111		217
2001*		110	-	92		202

*Preliminary. ⁽¹⁾ See Ling VII.

LING VIIg-k

Year	Belgium	Denmark	France	Germany	Ireland	Norway	Spain ⁽²⁾	E&W	IOM	N.I.	Scot.	Total
1988	35	1	(1)	-	286	-	2,652	1,439	-	-	2	4,415
1989	23	-	(1)	-	301	163		518	-	+	7	1,012
1990	20	+	(1)	-	356	260		434	+	-	7	1,077
1991	10	+	(1)	-	454	-		830	-	-	100	1,394
1992	10	-	(1)	-	323	-		1,130	-	+	130	1,593
1993	9	+	(1)	35	374			1,551	-	1	364	2,334
1994	19	-	(1)	10	620		184	2,143	-	1	277	3,254
1995	33	-	1597	40	766	-	195	3046		⁽³⁾	454	6,131
1996	45	-	1626	169	771		583	3209			447	6,850
1997	37	-	1,574	156	674		33	2112			459	5,045
1998	18	-	1,362	88	877		1669	3,465			335	7,814
1999	-	-	1,229	49	554		455	1,619			292	4,198
2000*	17		1006	12	624	-	518	921			303	3,401
2001*			963	4	727	24	490	591			285	3,084

*Preliminary. ⁽¹⁾ See Ling VII. ⁽²⁾ Includes VIIb,c. ⁽³⁾ Included in UK (EW).

LING VIII

Year	Belgium	France	Germany	Spain	E & W	Scot.	Total
1988		1,018			10		1,028
1989		1,214			7		1,221
1990		1,371			1		1,372
1991		1,127			12		1,139
1992		801			1		802
1993		508			2		510
1994		n/a		77	8		85
1995		693		106	46		845
1996		825	23	170	23		1,041
1997	1	705	+	290	38		1,034
1998	5	1,220	-	543	29		1,797
1999	22	232	-	188	8		450
2000*	1	218		56	5		280
2001*		167		333	7	2	509

*Preliminary

Table 7.1. continued

LING IX

Year	Spain	Total
1997	0	0
1998	2	2
1999	1	1
2000*	1	1
2001*	0	0

*Preliminary

LING XII

Year	Faroes	France	Norway	E & W	Scotland	Germany	Ireland	Total
1988				-				0
1989				-				0
1990				3				3
1991				10				10
1992				-				0
1993				-				0
1994				5				5
1995	5			45				50
1996	-		2					2
1997	-		+	9				9
1998	-	1	-	1				2
1999	-	0	-	-	+	2		2
2000*		1	-		6			7
2001*		0	29	2	24		4	59

*Preliminary

LING XIV

Year	Faroes	Germany	Iceland	Norway	E & W	Scotland	Total
1988		3	-	-	-	-	3
1989		1	-	-	-	-	1
1990		1	-	2	6	-	9
1991		+	-	+	1	-	1
1992		9	-	7	1	-	17
1993		-	+	1	8	-	9
1994		+	-	4	1	1	6
1995	-	-		14	3	0	17
1996	-			0			0
1997	1			60			61
1998	-			6			6
1999	-			1			1
2000*			26	-			26
2001*				35			35

*Preliminary.

Table 7.1. continued

Ling, total landings by Sub-areas or Division

Year	I	IIa	IIb	III	IVa	IVb,c	Va	Vb1	Vb2	VIa	VIb	VII	VIIa	VIIb,c	VIIId,e	VIIIf	VIIg-k	VIII	IX	XII	XIV	All areas
1988		6,119	7	331	11,223	379	5,861	2,372	2,116	14,556	1,765	5,057	211	865	779	444	4,415	1,028	0	3		57,531
1989		7,368		422	11,677	387	5,612	2,962	1,690	8,631	3,743	5,261	311	577	700	310	1,012	1,221	0	1		51,885
1990		7,628		543	10,027	455	5,598	3,062	795	6,730	1,505	4,575	169	678	799	233	1,077	1,372	3	9		45,258
1991		7,793		484	9,969	490	5,805	3,465	1,047	4,795	2,662	3,977	125	749	680	302	1,394	1,139	10	1		44,887
1992		6,521		549	10,763	842	5,116	2,400	1,214	4,588	1,891	2,552	105	1,286	519	137	1,593	802	0	17		40,895
1993		7,093		642	12,810	797	4,854	2,242	614	5,301	1,522	2,294	219	1,434	436	223	2,334	510	0	9		43,334
1994		6,309	13	469	11,496	323	4,604	2,657	965	6,730	2,540	2,185	284	1,595	451	400	3,254	85	5	6		44,371
1995		5,954		412	13,041	659	4,192	3,286	784	8,847	1,638		305	1,944	1,389	602	6,131	845	50	17		50,096
1996	136	6,083	127	402	12,705	1,424	4,060	3,996	900	8,577	1,124		210	2,201	1,477	399	6,850	1,041	2	0		51,714
1997	31	5,373	5	311	11,315	699	3,933	4,733	924	6,746	814		264	1,780	1,472	547	5,045	1,034	0	9	61	45,096
1998	123	9,072	5	214	13,631	627	4,302	4,029	1,330	7,362	1,394		198	1,034	1,500	561	7,814	1,797	2	2	6	55,003
1999	64	7,581	6	216	9,810	446	4,647	4,576	662	6,899	1,175		84	1,366	1,053	312	4,198	450	1	2	1	38,907
2000*	69	5,891	4	228	9,246	384	3,743	3,320	399	6,540	1,879		73	1,175	838	217	3,401	280	1	7	26	37,721
2001*	66	4,851	33	252	7,841	282	3,320	3,821	679	5,076	788		87	1,217	783	202	3,084	509	0	59	35	32,985

*Preliminary.

Table 7.2. Effort and cpue in ling, as calculated from the Icelandic long-line logbook data.

Effort - No of hooks (*10000)

Ling	
1994	3401
1995	4237
1996	3962
1997	3332
1998	3251
1999	5478
2000	5916
2001	4776

CPUE (g/hook)

Ling	
1994	42.9
1995	30.1
1996	33.6
1997	43.5
1998	48.5
1999	38.5
2000	29.2
2001	33.7

Table 7.3. Ling. Catch per unit effort of Danish trawlers in Sub-areas IVa and IIIa.

DENMARK:

Logbook recorded catch and effort.

Species: **Ling**

Area: **IVA**

Year	Mesh size in Trawl:												All trawls CPUE
	>100 mm			70 - 100 mm			30 - 45 mm			< 25 mm			
	Kg	days	CPUE	Kg	days	CPUE	Kg	days	CPUE	Kg	days	CPUE	
1992	42495	310	137.1	199651	1780	112.2	4059	165	24.6	232918	1542	151.0	126.2
1993	24744	212	116.7	166759	1288	129.5	18245	512	35.6	253771	1799	141.1	121.6
1994	6434	87	74.0	213367	1758	121.4	6907	209	33.0	164916	1072	153.8	125.3
1995	3480	42	82.9	195463	1212	161.3	6195	197	31.4	119565	695	172.0	151.3
1996	2113	40	52.8	315231	2169	145.3	7729	177	43.7	76210	747	102.0	128.1
1997	81030	193	419.8	425886	2183	195.1	4310	120	35.9	47360	459	103.2	189.0
1998	40955	310	132.1	291986	1518	192.3	14479	161	89.9	47413	456	104.0	161.5
1999	79105	409	193.4	371259	2286	162.4	14553	326	44.6	22141	330	67.1	145.3
2000	35800	274	130.7	346237	2650	130.7	6972	224	31.1	32625	375	87.0	119.7
2001	139215	614	226.7	448600	3161	141.9	12685	297	42.7	117185	348	336.7	162.4

DENMARK:

Logbook recorded catch and effort.

Species: **Ling**

Area: **IIIa**

Year	Mesh size in Trawl:												All trawls CPUE
	>100 mm			70 - 100 mm			30 - 45 mm			< 25 mm			
	Kg	days	CPUE	Kg	days	CPUE	Kg	days	CPUE	Kg	days	CPUE	
1992	4749	90	52.8	15431	363	42.5	2315	84	27.6	3335	51	65.4	43.9
1993	8060	166	48.6	55717	649	85.9	2228	96	23.2	8630	31	278.4	79.2
1994	5703	69	82.7	23369	390	59.9	915	41	22.3	2220	3	740.0	64.0
1995	4694	81	58.0	13406	270	49.7	672	30	22.4	260	5	52.0	49.3
1996	2732	55	49.7	9810	245	40.0	662	19	34.8	235	7	33.6	41.2
1997	1565	34	46.0	4362	157	27.8	350	10	35.0				31.2
1998	1325	19	69.7	3042	87	35.0	470	13	36.2	175	3	58.3	41.1
1999	948	28	33.9	2290	77	29.7	2709	79	34.3				32.3
2000	206	7	29.4	7688	211	36.4	1360	11	123.6				40.4
2001	2300	31	74.2	14886	304	49.0	65	2	32.5	1400	7	200.0	54.2

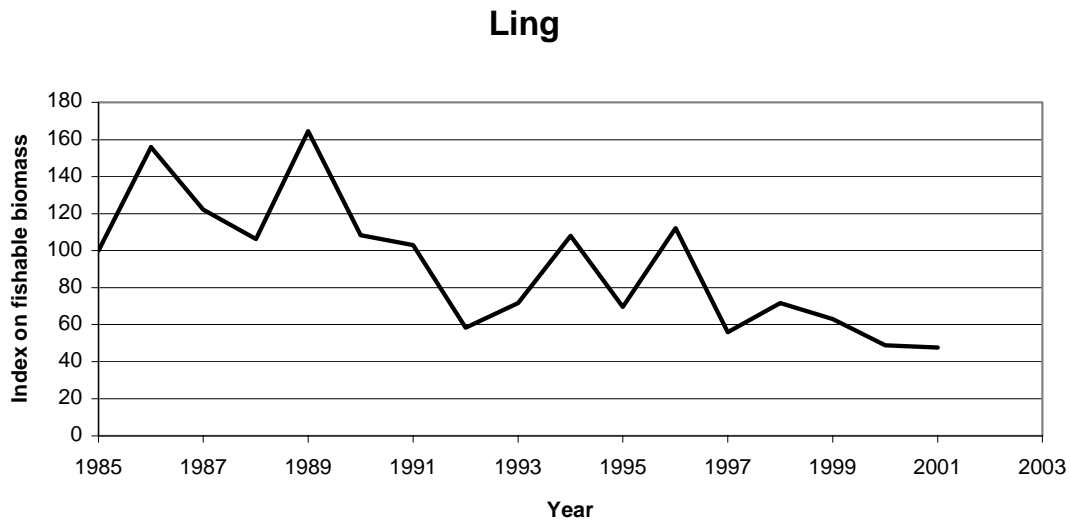
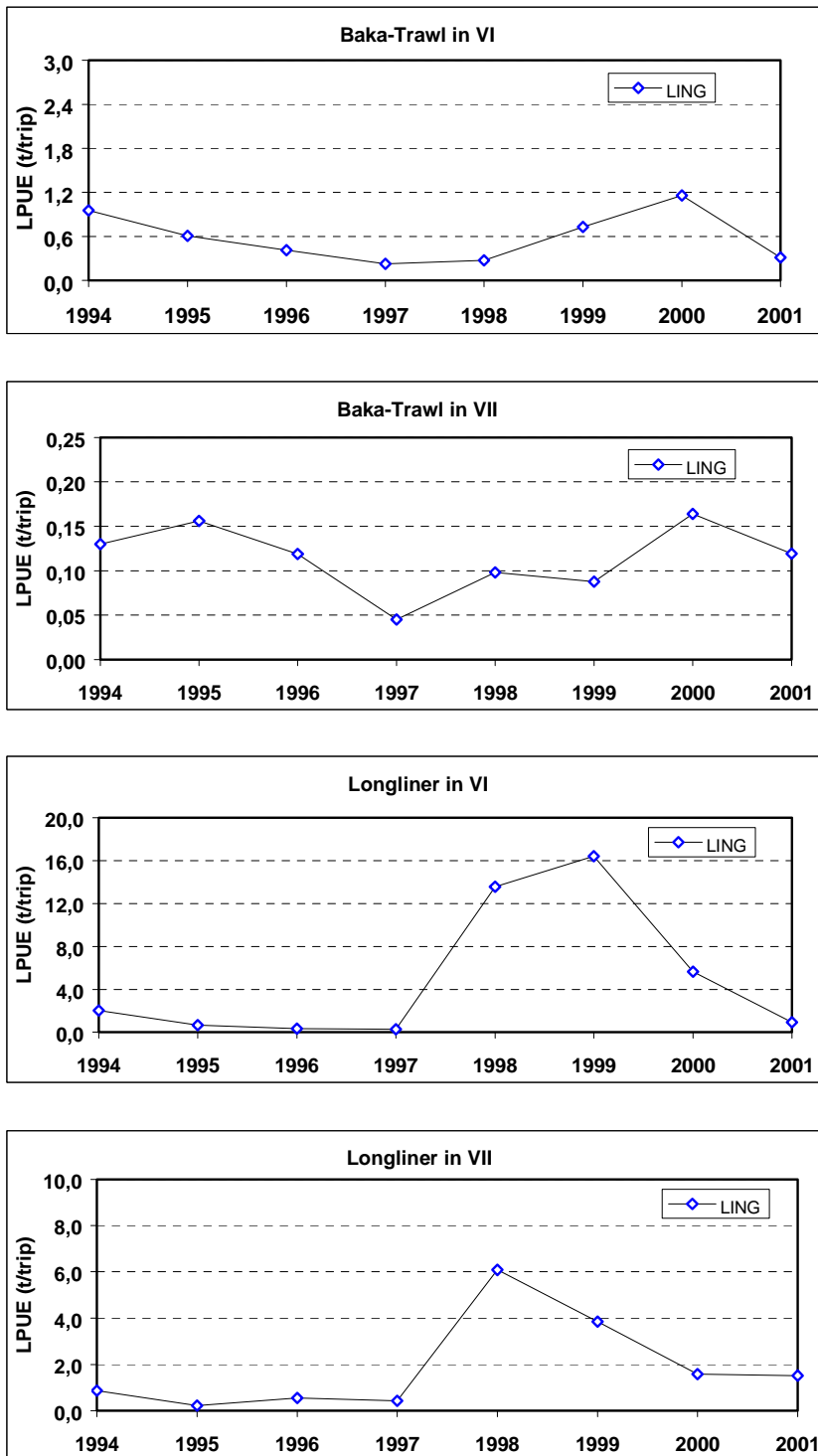

Figure 7.1. Ling. Index on fishable biomass calculated from the Icelandic groundfish survey at the Icelandic shelf.

Figure 7.2. Landings per fishing effort (LPFE: tones/trip) of Basque “Baka” trawlers and longliners in Sub-areas VI and VII (extracted from working document by Lucio *et al.*). (Data on 2001 are preliminary). Data for longliners represent 1-3 vessels only.



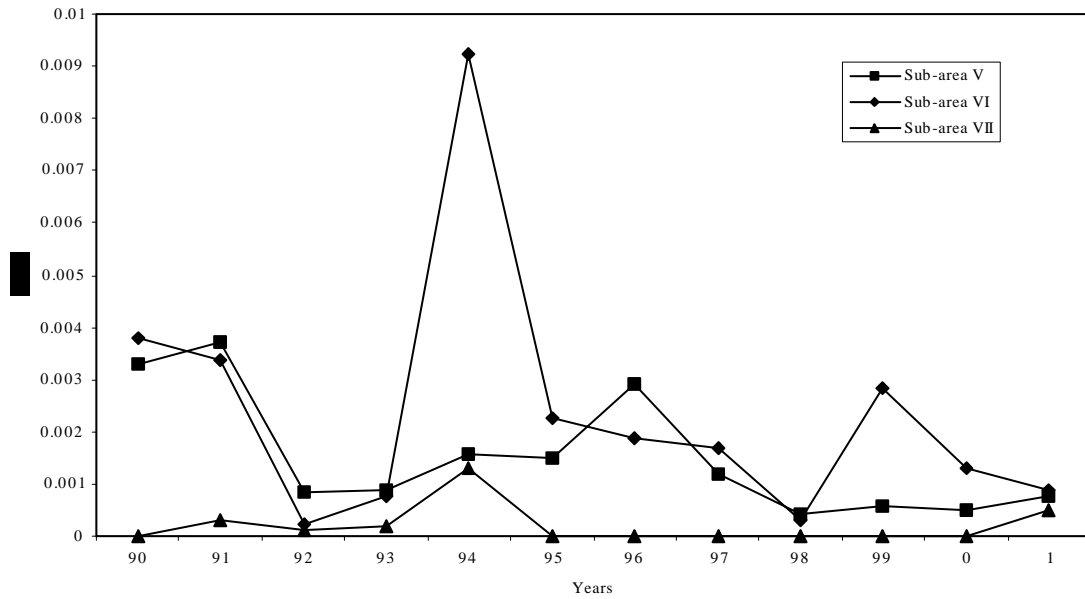

Figure 7.3. CPUE (tonnes/h) of the French deep water trawling fleet in division Vb and sub-areas VI and VII.

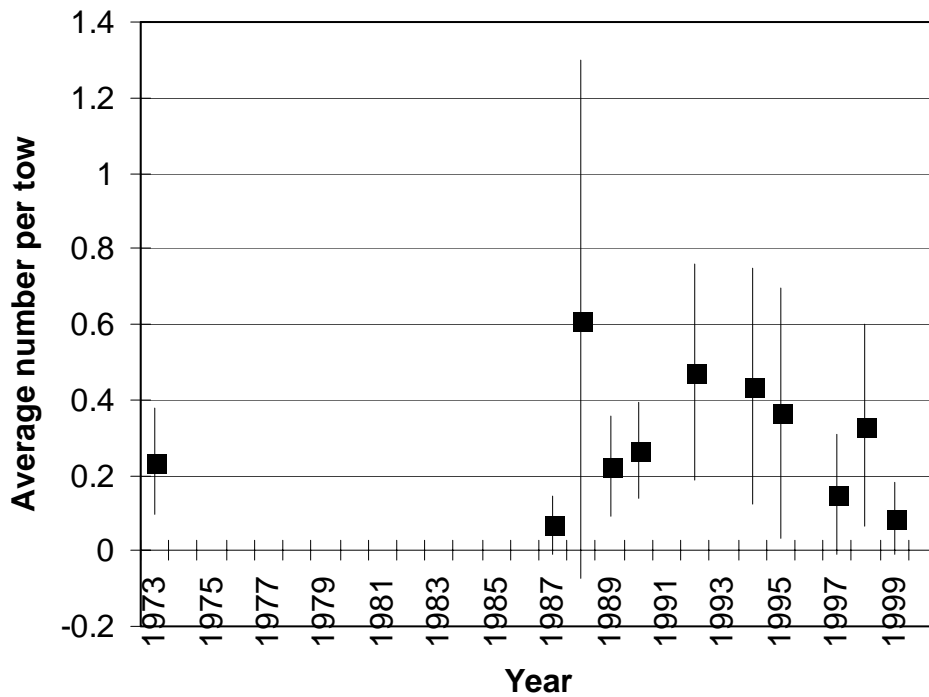

Figure 7.4. Average number of ling caught per trawl tow (with 95% confidence interval) in the EVHOE cruise in the bay of Biscay.

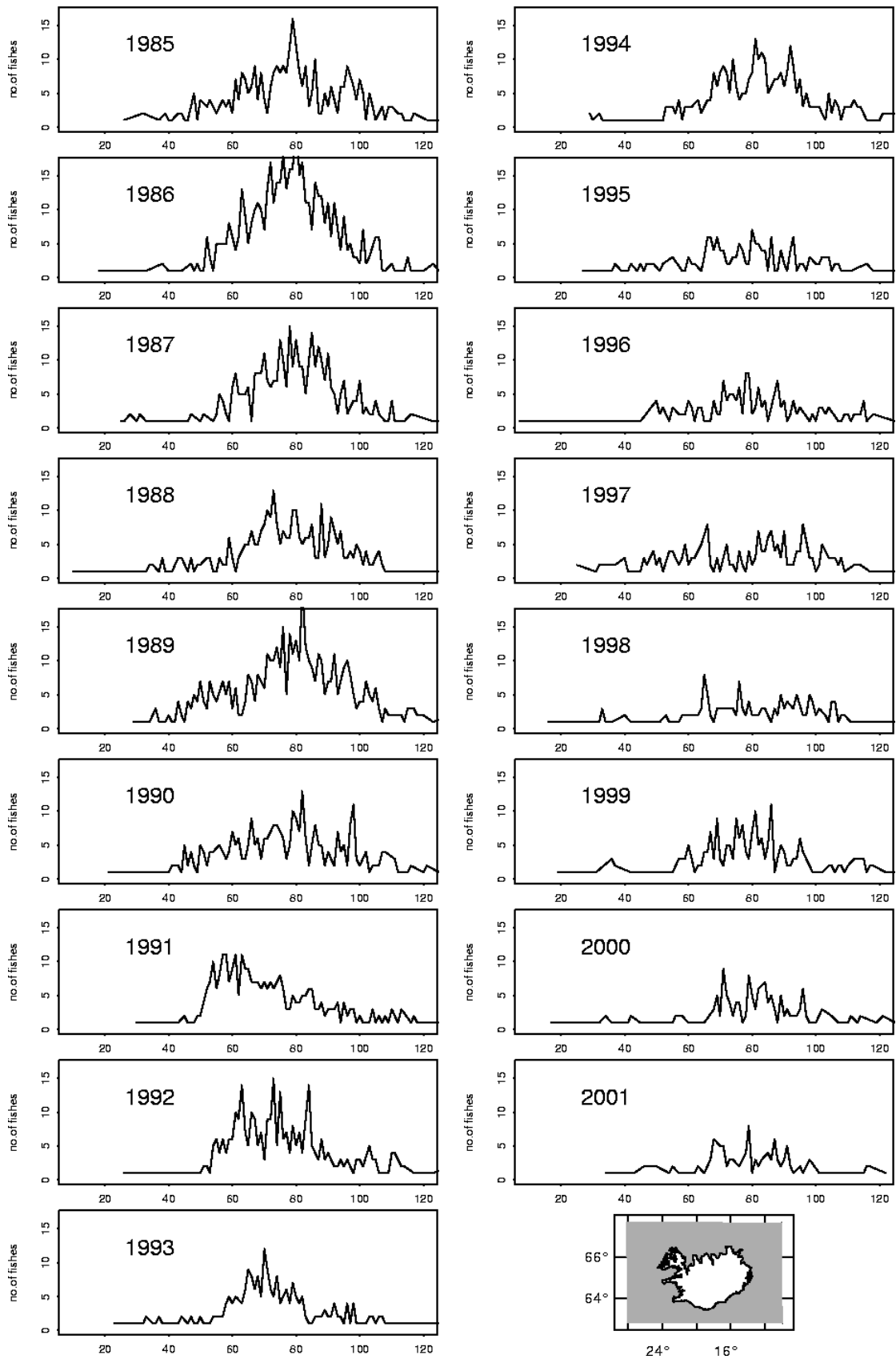
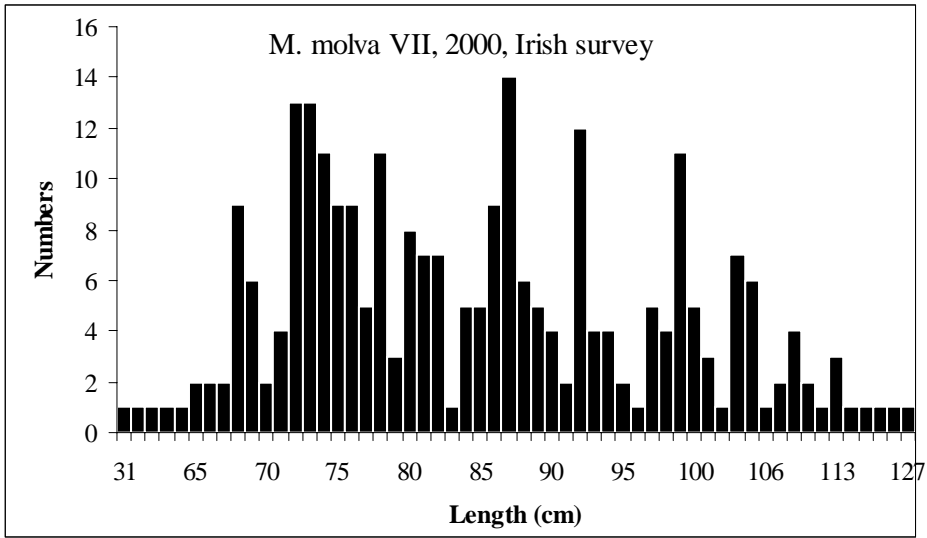

Figure 7.6. Ling length distributions in the Icelandic groundfish survey in March 1985-20

Figure 7.7. Length frequency for *M. molva* from Irish longline survey in Sub area VII.



Argentina silus has been targeted in trawl fisheries off mid-Norway (Division IIa) and the Skagerrak (IIIa) since the late 1970s. These fisheries have continued as described in ICES C.M. 1996/ Assess:8, but the effort directed at *A. silus* varies strongly with market demand. In Division IIa landings declined from top levels at 10 000–11 000 t in the mid 1980s to about half that level in the early 1990s. In the most recent years there has been a slight increase. The fishery in the Skagerrak is conducted by 1–3 trawlers and annual landings were 1 000–2 000 t/year in the late 1980s and early 1990s. Since then the activity declined and varied considerably, and landings ranged from less than 10 to 700 tonnes per year. In the Skagerrak (IIIa) and the northeastern North Sea (IVa), there are, however, trawl fisheries for Norway pout, blue whiting and deep-water shrimp (*Pandalus borealis*) that may have significant by-catches of *Argentina silus*.

No landings of by-catches of *Argentina silus* in the pelagic trawl fishery for blue whiting to the west of Scotland and Ireland (Sub-areas VI and VII) were recorded in recent years.

There is a minor fishery in mid-Norway (IIa) targeting roundnosed grenadier *Coryphaenoides rupestris* and *Argentina silus*. Six 120-140 foot trawlers have licences. Details on this fishery were given in the report of the EC FAIR project (Gordon, 1999). The roundnosed grenadier is also a by-catch in the shrimp and *Argentina silus* fisheries in the Skagerrak (IIIa), but the by-catches not landed for human consumption have not been quantified. Interview-based estimates suggest a total catch of around 1000 t/year in the shrimp fishery alone. The recorded landings are at most a few hundred tonnes.

As described in previous reports, some exploratory trawling was carried out on the Hatton Bank (VIa) and along the Mid-Atlantic Ridge (XII), but these were short-term experiments that have not thus far lead to the development of lasting new fisheries.

Gillnet fisheries

There is an aimed gillnet fishery for ling (*Molva molva*) on the upper slope off mid-Norway (Area IIa). This fishery started in 1979 as an aimed fishery for blue ling, but the catches of that species declined through the following decade to the extent that the fishery has since the 1990s become almost entirely focused on ling.

6.1.7 Portugal

Mainland

The three main deep-water fisheries off mainland Portugal have been described in detail in the report of SGDEEP from 2000 (ICES CM 2000/ACFM:8). Some further details on the fishery targeting black scabbardfish (*Aphanopus carbo*) is given here. The commercial black scabbardfish fishery in continental Portugal started in Sesimbra, a fishing village situated to south of Lisbon. The fishing takes place on hard bottoms along the slopes of canyons off Sesimbra at depths normally ranging from 800 to 1200 m (Fig 6.1). It is important to stress the localized character of this fishery. It is restricted to a fraction of the area identified as the areas of distribution of the species based on scientific longline surveys conducted along the Portuguese continental coast (Fig .6.2). The longline gear used is designed to match the vertical distribution of the black scabbardfish and also to prevent gear loss on the hard grounds. This fishery has an artisanal character. Each fleet unit has a large number of fishermen involved. Usually associated with each fleet unit are two groups of workers; one working at sea and the other ashore, being responsible for the disentangling, baiting and coiling of the main line into the tubs. This is a time consuming and very labor intensive process, all done by hand.

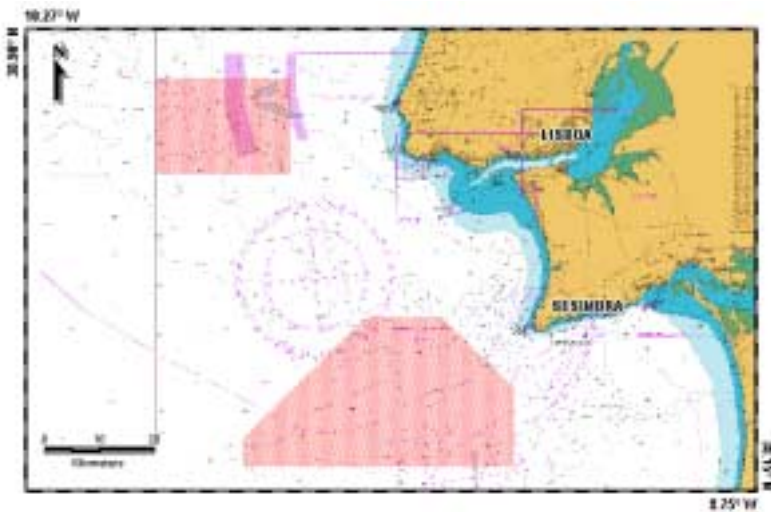

Figure 6.1. Fishing areas (shaded) of the Sesimbra fishery for black scabbardfish.

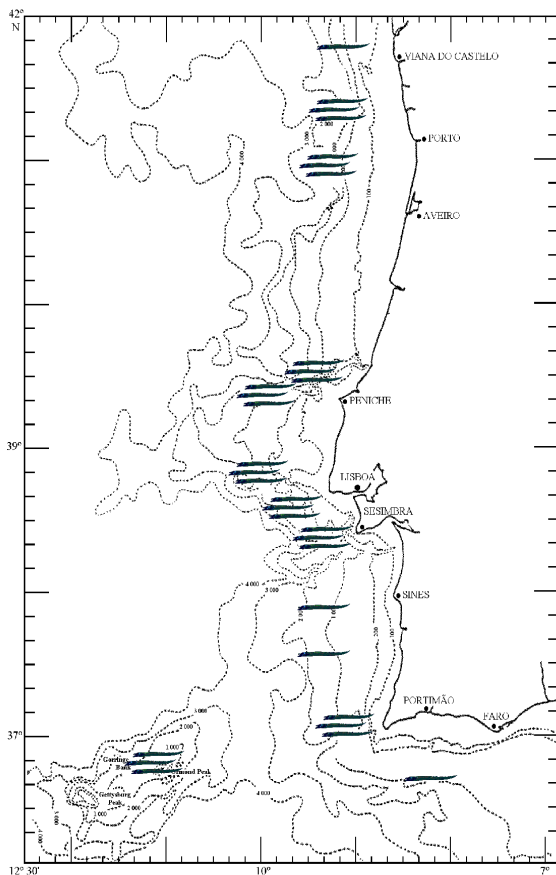

Figure 6.2. Distribution of the black scabbardfish areas along the Portuguese continental coast (from IPIMAR longline exploratory surveys).

Azores

The evolution of demersal fisheries in the Azores has undergone three main phases. The first phase, before the beginning of 1980s, the fishery was traditional and conducted by small open deck boats (<12 m) operating near the coast, using mainly handline and producing small and selective catches. A second phase, started at the early 1980s, was characterised by the introduction of the bottom longline gear and new fishing vessels (12-30 m longliners). New species and new fishing areas and depths were explored, new markets were developed, and an abrupt increase in the total demersal catches and fishing effort was observed. The third and current phase is characterised by a rather stable total catch and fishing effort, and some of

the stocks are considered to be intensively exploited. However, the effect of the multispecific character on the dynamics of the fishery is not yet very well understood.

This fishery can be considered as multispecific, since more than 20 species are caught by the longline fleet, the fleet that takes more than 80% of the catches. *Pagellus bogaraveo* is considered the target species, but other species have been caught and commercialised in significant quantities, like *Helicolenus dactylopterus*, *Conger conger*, *Beryx splendens*, *Beryx decadactylus*, *Pontinus khulii*, *Polyprion americanus*. Small quantities of other deeper-living species are also caught occasionally, e.g. *Mora mora*, *Phycis blennoides*, *Molva dypterygia macrophthalma*, *Epigonus telescopus*, and some elasmobranch species like *Deania calceus*, *Deania profundorum*. Landings of some of these species are pooled in the fishery statistics and/or are not discriminated. Catches of demersal and deep-water species by the local fleets are all sold at auctions in the Azores.

At present the catches of kitefin shark (*Dalatias licha*) are made by the longline and handline deep-water fleets and can be considered as accidental. There are no vessels at present catching this species using gillnets. This change was related to local market problems and not with the biological state of the stock.

In May-September of 1998 and August-November 1999 two longliners from Madeira, operated in the Azores (Area X), targeting black scabbardfish. The catch rates were high and a fishery may develop for this species in the region in the near future. These commercial fishing experiments were undertaken with observers on board and some data were collected. Some *Centropristis squamosus* were caught as by-catch. Experiments conducted by the industry will continue during 2002.

Madeira

The most important deep-water fishery in Madeira (Portugal) is the longline fishery for black scabbardfish (*Aphanopus carbo*). The number of vessels is declining. In fact in 1988 there were 90 fishing vessels while in 1999 only 40 were engaged in this fishery. Despite this decline, effort in terms of number of hooks maintained throughout the series at the same level. The fishing vessels are made of wood with open deck; with an average overall length of 9m, a mean power of engine of 80 Hp and an average gross registered tonnage of 12 tonnes. There are around 500 fishermen directly involved in this fishery (Sena-Carvalho, Reis and Afonso-Dias, in preparation).

6.1.8 Russian Federation

The recent Russian deep-water fishery in 2000-2001 has been described by Vinnichenko *et al.* (WD 2002).

Mid-Atlantic Ridge

In 2000 fishery for roundnose grenadier has been initiated in March by one vessel of 9th-tonnage class. In May, second trawlers of 9th-tonnage class started to operate. The trawlers had stopped the fishery in October. The whole period in 2000, vessels operated between 49-51°N (Sub-area XII). According to provisional data the catch of grenadier was 1918 t (Table 6.1, Table 6.2). In catches of roundnose grenadier taken by bottom trawls in August and October, orange roughy were found from time to time. Total catch of orange roughy constituted 12 t.

In March-April 2001 one trawler of 10th-tonnage class operated in the southern part of the Sub-area XII. In May this vessel continued the fishery in the north of the Sub-area XII. In July one trawler of 10th-tonnage class and one trawler of 11th-tonnage class operated in the central and northern parts of Sub-area XII and southern part of Division XIV b. Further on from August to December one trawler of 11th-tonnage class operated in the southern part of Sub-area XII. In September-October one trawler of 9th-tonnage class joined the fishery for grenadier. During the fishing season the fleet operated from 48° to 62° N fishery. Catch was 1786 t (Table 6.2, Table 6.3), including 1714 t in Sub-area XII and 72 t in Division XIV b.

North-Azores seamounts

In March 2000, one trawler of 9th-tonnage class fished over for a short time golden eye perch on the seamounts between 44-45° N (Sub-area X) with the efficiency of 1.9-2.6 t per fishing day. Total catch constituted 5 t.

Rockall

In the area outside 200-mile zone (division VI b) the fishery, mainly on grey gurnard, haddock and small redfish, was conducted with bottom trawls in March-December. Operating deeper than 250m argentine, ling, blue ling, tusk and

various species of Macrouridae were found from time to time (Table 6.4). Among the named species, argentine was caught in the largest number with bottom trawls. This species was also found in catches of vessels fishing for blue whiting with pelagic trawls on the Rockall. In March-April the percentage of ling in bottom trawl catches reached sometimes 1-5 %. Tusk, blue ling and grenadiers were found in catches as single specimens.

In December 2001 one long-liner carried out exploratory fishing on western slope of the bank in the depth interval of 280-1070 m. The catches varied from 10 to 260 kg per 1000 hooks and contained tusk, greater forkbeard, ling, blue ling, haddock, mora, bluemouth, skates and sharks. A total of 12 t of commercial deep-sea species were fished.

Hatton Bank

Short-time exploratory fishing was carried out with 2 trawlers in the Division VI b in March 2000. At depths of 870-950 m for 3 trawling hours, the catches were taken as follows: up to 1 t blue ling (30-32 %), rabbitfish (25-30 %), sharks (20 %), roundnose grenadier (10-15 %) and black scabbardfish (8-10 %). At depths 770-820 m for 2 trawling hours it was caught 0.5 t of rabbitfish (80 %) with by-caught blue ling (4 %) and roundnose grenadier (15 %).

Louzy Bank

In June 2000, one trawler carried out fishery for small redfish in the international waters (Division V b). Occasionally, argentine was found in catches from the depth of 230-250 m taken by bottom trawl and this species total catch constituted 5 t (Table 6.5).

In the end of March, one trawler of 9th-tonnage class carried out short-time exploratory fishing in the international waters (560-1115 m depth). Catches per trawling did not exceed 0.4 t of blue ling, velvetbelly shark, chimaera, roundnose grenadier, redfish and black scabbard fish.

Faroe fishing zone

In April-May large-tonnage fleet was fishing with pelagic trawls. From time to time, a big by-catch of argentine was found in catches of blue whiting. A total catches of argentine in Division V b were 514 t in 2000 and 414 t in 2001 (Table 6.5).

In March 2000 during exploratory fishing on Louzy Bank (1.010-1.080 m depth), catches per 1 trawling hour did not exceed 150 kg of sharks (25-47 %), roundnose grenadier (to 43 %), rabbitfish (to 100 %). At depths of 520-550 m 2.5 t were caught per 2 trawling hours (67 % of blue whiting and 30 % of argentine). On the Faroe Bank (750-950 m depths) catches per 3 trawling hours varied from 0.5 to 1.5 t of which sharks, black scabbard constituted 30 % each and roundnose grenadier, blue ling - 15-20 % each. On the Bill Bailies Bank, the catches at the depth of 750-1.200 m constituted 1.5-4 t of deep-water sharks (50-60 %) with by-catch of roundnose grenadier, blue ling, rabbitfish and smoothhead (5-15 % each).

Norwegian Sea

Greater silver smelt were sometimes caught with pelagic trawl during the fishery for blue whiting in the southern part of Division II a (Table 6.6). The species was also caught in small quantities with bottom trawl south of the Bear Island and of the North Cape.

Longliners and trawlers fishing for demersal species by-caught sometimes tusk and roughhead grenadier (Table 6.6, Table 6.7). Tusk was usually fished in small amounts over a vast area most frequently with long-lines on the continental slope in the depth interval 300-800 m, where its proportion in catches was 1-5%. The major part of catch was taken in Division II a (Table 6.6, Table 6.7). Catches usually did not exceed 100 kg per 5-6 thou. hooks. On the Malangen and Vesteraalen Banks (depth 550-750 m) in some instances tusk dominated the catch (up to 60%) with the catch rate being 10-130 kg per 1000 hooks. On the Kopytov Bank the catch was as large as 40 kg per 1000 hooks. Tusk was relatively seldom caught with bottom trawl.

Catches of roughhead grenadier were mainly discarded by longliners and trawlers and were as a rule not registered in vessels' daily reports. The grenadier were processed and frozen only onboard some vessels (Table 6.6, Table 6.7). As reported by research and exploratory fishing vessels this species was most numerous on the western slope of the Bear Island Bank, on the Kopytov Bank, in the area between Spitsbergen and the Bear Island at the depth of 500-800 m, where the catches by bottom longline reached 100-200 kg per 1000 hooks. Catches at depths of 200-400 m did not

exceed 20 kg per 1000 hooks. In the bottom trawl catches the proportion of roughhead grenadier was small. It occurred mostly in Div. II b and its catch did not exceed 50 specimens per one trawling hour.

Other deep-water species such as greater forkbeard, roundnose grenadier, ling and greater silver smelt were much more scarce. Ling was occasionally caught with long-line on the western slope of the Bear Island Bank and Kopytov Bank in depth 400-600 m. Roundnose grenadier was found as single individuals in bottom trawl catch from depth 600-1000 at West Spitsbergen.

Barents sea

Tusk, greater forkbeard and roughhead grenadier occasionally occurred in the long-line catches (did not exceed 10-40 kg per 1000 hooks) in the western part of the Sub-area I. During bottom trawl fishery sharks, roughhead grenadier and greater silver smelt were by-caught sometimes. All the catch of sharks and grenadier was thrown out. Species composition of sharks caught by fishing trawlers is unknown.

Table 6.1. Results from operation of the Russian commercial fleet (trawlers of 9th-tonnage class) at the Mid-Atlantic Ridge (Sub-area XII) in 2000 (preliminary data)

Month	No. of ship-days actual fishing	Total catch (live weight), t	Catch per shipday of fishing, t
April	20	89	4.5
May	35	250	7.1
June	38	483	12.7
July	51	499	9.8
August	36	282	7.8
September	25	213	8.5
October	3	31	10.3
Total	217	1918	8.8

Table 6.2. Catch of roundnose grenadier by USSR/Russia fishing fleet at the Mid-Atlantic Ridge in 1973-2001, x 1000 t

Year	Catch	Year	Catch	Year	Catch	Year	Catch	Year	Catch
1973	0.2	1979	6.1	1985	5.8	1991	3.2	1997	0.7
1974	5.9	1980	17.4	1986	22.8	1992	0.3	1998	0.8
1975	29.9	1981	13.0	1987	10.9	1993	0.5	1999	0.6
1976	4.5	1982	12.5	1988	10.6	1994	-	2000*	1.9
1977	9.4	1983	10.3	1989	9.5	1995	-	2001*	1.8
1978	12.3	1984	6.6	1990	2.8	1996	0.2		

* Provisional data

Table 6.3. Preliminary results from the Russian fisheries for roundnose grenadier at the Mid-Atlantic Ridge in 2001 (Sub-area XII and Division XIV a)

Month	Tonnage class of vessel	No. of ship-days actual fishing	Total catch (live weight), t	Catch per shipday of fishing, t
March-April	10	25	301.9	12.1
May	10	5	70.8	14.2
July	10	12	221.0	18.4
	11	28	234.5	8.4
	Total	40	455.5	
August	11	13	170.6	13.1
September	09	3	32.4	10.8
	11	15	120.3	8.0
	Total	18	152.7	
October	09	8	36.2	4.5
	11	19	226.8	11.9
	Total	27	263.0	
November	11	12	155.2	12.9
December	11	16	215.7	13.5
Grand total:			1785.4	

Table 6.4. Catch (t, live weight) of deep-water species taken by the Russian fishing fleet in Division VI b in 2000-2001 (preliminary data)

Species	Year	
	2000	2001
Blue ling	1	-
Ling	7	-
Tusk	1	5
Argentine	23	76
Roundnose grenadier	2	3
Other Macrouridae	7	-
Greater forkbeard	-	4
Total	41	88

Table 6.5. Catch (t, live weight) of deep-water species taken by the Russian fishing fleet in Division V b in 2000-2001 (preliminary data)

Species	Year	
	2000	2001
Greater silver smelt	519*	414
Blue ling	1	-
Tusk	1	-
Roundnose grenadier	1	-
Total	522	414

* - including 514 t in Faroe 200-mile zone and 5 t in international waters

Table 6.6 Catch (t, live weight) of deep-water species taken by the Russian fishing fleet in Division II a in 2000-2001 (preliminary data)

Species	Years	
	2000	2001
Tusk	58	66
Greater silver smelt	195	7
Roughhead grenadier	4	4
Greater forkbeard	-	4
Total	257	81

Table 6.7. Catch (t, live weight) of deep-water species taken by the Russian fishing fleet in Division II b in 2000-2001 (preliminary data)

Species	Years	
	2000	2001
Sharks	30	-
Tusk	3	5
Roughhead grenadier	9	16
Total	42	21

Table 6.8. Catch (t, live weight) of deep-water species taken by the Russian fishing fleet in Sub-area I in 2000-2001 (preliminary data)

Species	Years	
	2000	2001
Sharks	3	-
Tusk	43	6
Greater forkbeard	-	3
Total	46	9

6.1.9 Spain

A comprehensive description of the Spanish deep-water fisheries in the NE Atlantic was given in the 1998 report of the SGDEEP (ICES CM 1998/ACFM 12) and published by Piñeiro *et al.* (2001). In the present WGDEEP three WDs related to different segments of the Spanish fleet fishing deep sea species have been presented.

Multi-species deep-sea bottom trawl commercial fishery at Hatton Bank

A detailed description of this fishery (1996-2000) have been presented to the 2001 NAFO Deep-sea Fisheries Symposium (Duran *et al.* 2001) and update information is given in Duran *et al.* (2002) (Working Document). The fishery is carried out by freezer trawlers (35-84 m length) in international waters of the Hatton Bank, mainly in ICES Subarea XII and partially in Division VIb, using bottom trawl gear called "pedreira". The main commercial fish species are smoothheads, roundnose grenadier, blue ling and Portuguese dogfish. The presence of the majority of the vessels in this fishing ground is discontinuous, according to fishing opportunities in other North Atlantic grounds. Vessels conducted one to four fishing trips per year, of variable duration (1 week to 4 month aprox.). The fleet worked in Hatton Bank during a total of 1363 days in the year 2000 and 1627 days in the year 2001 (estimated days in the fishing ground), corresponding to 22202 and 26123 estimated hours trawling, respectively. As in the previous years, the fishing operations were conducted at depths mainly between 800-1600m. Since 1998, a gradual movement of the fishing effort towards the deeper bottoms occurred. This fishery involved a total of 24 bottom trawlers in the year 2000 and 28 in 2001. However few of these vessels worked full time in this fishing ground (two in 2000 and four in 2001). In addition,

some of the trawlers were operating occasionally in international waters at Reikjanes Ridge (ICES Division XIVb), during few days of the spring targeted to blue ling.

The artisanal longline (“voracera”) fleet in Division IXa

A new description of the Spanish fishery in the southern part of Div. IX, in the Strait of Gibraltar, has been presented to the Study Group by Gil *et al.* (WD) that updates the information offered in the past working group (Gil *et al.*, 2000). In 2001 around 100 vessels fished red seabream in a very small area close to the Gibraltar Strait. All catches are landed in only two ports, Algeciras and mainly in Tarifa. The standard vessel is a boat 6-9 m overall length, displacing around 5 GTR and with 3 to 5 crew. As the fishery has experienced an important decline of the catches in the recent years, a local Fishing Plan conducted by the Spanish Central Government and the Regional Government of Andalusia has been implemented in 1999 for the resource recuperation. Between the regional technical measures adopted there are: the closure of the fishing season during two months (February - March) in the 1999-2001 period, maximum number of lines per boat (30), hook size and maximum number per line (100), maximum number of automatic machines for hauling per boat (3), minimum size of fish retained or landed (25 cm total length).

The Basque Country fishery

An overview of the updated Basque deep-sea fishery has been presented to the WD by Lucio *et al.* As in the last years almost all the catches obtained by this fleet can be considered as by-catches of the bottom trawlers (mainly “baka” otter trawl) and longliners. A main feature of this fleet in the period 1994-2000 is the significant and continued reduction in the total number of the fishing boats, mainly longliners and bottom trawlers (“baka” and “bou”). In this period, only four species -Ling, Tusk and Greater forkbeard and Blue ling- amount for more than the 90% of total Basque deep-sea fish landings. The increment of the landings of some species is partly explained by the relatively increased fishing effort directed by some metiers to these deepsea (and other) species, before more focused on hake. The Basque fleet fish in three very different Northeast Atlantic areas: Bay of Biscay (Divisions VIII a,b,d), Sub-area VII (mainly in Divisions VII h,j,k), and in Sub-area VI (principally in Division VI a; but sometimes also in Division VI b, in the Rockall Bank). By the other hand, the artisanal fleet acts in the eastern part of Division VIII c and in the southern part of Division VIII b. Most of the landings (about two thirds) come from catches in Sub-area VI. The Basque red seabream fishery, the most traditional and important of the deep-sea fishery until middle of 80's, continues in the same fall down situation as in the last years and thus at present no boat is focused on this species.

6.1.10 Denmark

Among the species classified as deep-sea species Ling, Tusk, Roundnose Grenadier and Greater Silversmelt are the only ones of importance to the Danish fisheries at present. During the last 10 years a few Danish vessels have conducted fisheries targeting Roundnose grenadier and Greater Silversmelt, mainly in the Skagerrak (ICES Sub-area IIIA). But apart from the landings by these vessels, the Danish landings of deep-sea species are mainly taken as by-catch in various trawl fisheries carried out in ICES sub-areas IIIA and IVA. These trawl “fleets” may be grouped according to mesh size in the trawls:

- Bottom trawls, mesh size > 100 mm targeting mainly roundfish species.
- Bottom trawls, mesh size 70 - 100 mm targeting *Nephrops* and roundfish.
- Bottom trawls, mesh size 30 - 45 mm targeting deep-water shrimp (*Pandalus*).
- Bottom trawls, mesh size < 25 mm targeting fish species for reduction.

According to the Danish logbook records for these species the majority of catches are taken by trawls with mesh size 70-100 mm (mixed *Nephrops* and roundfish trawls). Second in importance are the by-catches in the shrimp trawl (mesh size 30- 45 mm).

At present most of the Danish landings of Roundnose grenadier are used for oil and meal, while a significant part of the landings of Greater Silversmelt is for human consumption. Most of the catches of these two species are taken in Skagerrak (ICES sub-area IIIA).

The majority of the Danish catches of Ling and Tusk are taken in the Norwegian Deep (ICES sub-area IVA) in the mixed fishery for *Nephrops* and round fish species (trawls with mesh size 70-100 mm). In addition, small quantities of Ling and Tusk are taken in line fisheries.

Also small quantities of Blue Ling as well as Rabbitfish (*Chimaera*) and Lantern shark (*Etmopterus*) are recorded in the by-catches.

6.1.11 Ireland

Ling and greater forkbeard have been the most consistently landed deepwater species by Irish vessels. These are taken in mixed trawl fisheries, on the continental shelf and slopes, but are now also been taken to some extent in deepwater longline operations, along with blue ling, deepwater sharks and mora. Greater argentine is targeted by pelagic trawlers in some years, for human consumption and fish meal. Landings have fluctuated from around 1000 t in 1997 to over 4000 t in 2000. Preliminary landing figures for 2001 are given in Table 6.10.

There has been much development of deepwater fisheries by Irish vessels in most recent years. Three new longliners target deepwater species, in various fisheries. Greenland halibut have been taken on longline at Hatton Bank, along with tusk and deepwater squalid sharks. There are by-catches of tusk in Sub-area II, in the Norwegian Sea. Ling and tusk have been targeted on the continental slopes of the Rockall Trough (Sub-area VI) and Porcupine Bank (Sub-area VII). Longline effort has also been directed at deepwater species at depths of more than 500 m, for sharks, greater forkbeard and mora.

Several new large trawlers have targeted deepwater species in Sub-areas VI and VII. The most important species is orange roughly, with up three vessels targeting the species, mainly in Sub-area VII, and preliminary landings have risen to over 2000 t. This directed fishery has low a by-catch, mainly of roundnose grenadiers and squalid sharks. Though cardinal is taken as a bycatch in this fishery also, it is not always landed. Some larger demersal trawlers prosecute a mixed-species fishery on the continental slopes of Sub-areas VI and VII for black scabbard, squalid sharks, blue ling, roundnose grenadiers, rabbitfish and forkbeards. Landings in this mixed-species fishery have also risen since 1999.

Table 6.10. Preliminary landings by gear for Irish vessels in 2001.

	Pel. Trawl	Dem. Trawl	Gillnets	Lines	Beam trawl	Seine	Misc.	Grand Total
Greater argentine	7485	13						7498
Black scabbard	2	65		1				68
Blue ling		531	24	6				561
Cardinal		216						216
Greater forkbeard		593	61	8		1		663
Roundnose grenadier		452						452
Ling		655	353	14	106	64	1	1267
Orange roughly		2477						2477
Rabbitfish		10		3				13
Siki sharks		99		115				214
Mora		8		17				25
Tusk		90		30				120
Wreckfish			1					1
Grand Total	7487	5209	439	195	107	64	1	13502

6.1.12 Netherlands

The Dutch fleet of pelagic freezer trawlers consists of 14 vessels, and another 6 vessels are sailing under different foreign flags but owned by Dutch companies. Length over all ranges from 90 - 140 m. The fleet is specialized in small pelagics such as herring (*Clupea harengus*), horse mackerel (*Trachurus trachurus*) and sardinella (*Sardinella aurita*). Fishing grounds are around the British Isles, and off Mauritania. In search of new target species, a small scale fishery for greater argentine developed to the west of the British Isles since 1989. Effort in this fishery depends on availability of different species and exhaustion of quotas. Catches are sorted on board and whole fish are frozen in packets of 22-25 kg. Total annual landings of argentine have been around 5000 t.

The main catches of greater argentine are from west and north-west of the Hebrides, from depths ranging from 600-700 m. The samples from west of Ireland (Porcupine Bank) represent minor by-catches in the fishery directed at blue

whiting (*Micromesistius poutassou*). Samples from further south are very small by-catches from a fishery for horse mackerel. (Source: poster by Heessen and Rink presented at the NAFO Deep-sea fisheries Symposium 2001).

6.1.13 United Kingdom

England and Wales

There has been little change to the UK(E+W) fisheries since last described in the 1998 report of the SGDEEP. Long-liners and gill netters target hake in (*Merluccius merluccius*) in VIa,b and VIj,k with deep-water sharks as a by-catch. Depending on market prices, sharks can sometimes be the target species. The majority of the catch is landed into Spain. Landings in England and Wales are confined mainly to Newlyn, as a by-catch from gill and drift netters, and to Milford Haven by long-liners and gill-netters.

Scotland

There has been little substantial change in the Scottish deep-water fleet since 2000. The majority of the demersal vessels involved in these fisheries continue to exploit a variety of fishing opportunities including the traditional shelf fisheries in the North Sea and west of Scotland, on the Rockall Bank and along the shelf edge fishery for monkfish and megrim as well as in deep water fisheries in the Rockall Trough and the Faroe-Shetland Channel. Vessels move between fisheries according to fishing opportunities, fish prices, quota restrictions and weather. This makes it very difficult to provide good estimates of the effort expended in deep water, however anecdotal evidence suggests that the fleet is increasing the proportion of its time spent in deep water fisheries in an effort to build up track record in anticipation of the introduction of TACs.

In addition to demersal vessels targeting the mixed deep-water fishery a number of large pelagic vessels have in recent years exploited greater argentine in area VIa. The majority of the catch of these vessels is landed overseas.

6.2 International waters

The Working Group continues to express concern over what appears to be extensive incomplete reporting of deep water catches and landings from international waters, i.e. outside national EEZs. Large fractions of Sub-areas X, XII, VI and XIV comprising parts of the fishing areas around the Rockall bank, Hatton bank and south-west part of Lousy bank, the Mid-Atlantic Ridge north of the Azores EEZ (Sub-area X), and part of the Reykjanes Ridge south of the Icelandic EEZ (Sub-areas XII, Division XIVb) lie outside EEZs.

This issue was discussed by SGDEEP in 2000 (ICES CM 2000/ACFM:8), and the background for the concern was described and illustrated by examples. The Working Group noted that the situation does not appear to have improved in more recent years. Many species dealt with by the Group have wide areas of distribution that extends from slope waters into oceanic areas outside national jurisdiction. The lack of complete data prevents the Group from evaluating the fisheries and stock status outside the areas under national or EU jurisdiction.

With reference to the concern expressed now and in previous reports, the Group continues to encourage the collection of data and reporting of catch and effort data from international waters.

6.3 Stock identity

The following overview was extracted from the report provided by a European Commission Subgroup of Fishery and Environment (SGFEN) under STEFC dealing with Deep-Sea Fisheries, that met in Brussels 22-26 October 2001 (working paper issued 1.2.2002 (SEC(2002)133). Many members of WGDEEP contributed to this report, and the updated overview on stock identity was considered relevant for the current report.

There have been very few studies of the stock-structure of deep-water fish species in the ICES area (ICES, 2000a, Menezes *et al.*, 2001, Large *et al.*, 2001). For assessment purposes, stock units have been defined on the basis of current knowledge of species distribution and similarity of observed catch-rate trends between ICES areas (ICES, 1998). Thus, stock units are currently individual or groups of ICES Sub-areas or occasionally ICES Divisions. This is not ideal because these ICES statistical areas were devised for the continental shelf and are, in many instances, inappropriate for deep-water fisheries (Coggan, 1997). For example, ICES Sub-area VI is divided into two Divisions. Division VIa covers the shelf along the continental margin and VIb the Rockall Plateau. Division VIa, however, includes both the Rockall Trough and a part of the Faroe-Shetland Channel. The deep-water fish faunas of these two areas have little in common (Gordon, 2001). Division VIb extends westwards from the Rockall Plateau and is contiguous with Sub-area

XII at longitude 18°W and in doing so bisects the Hatton Bank, which has a rapidly developing deep-water fishery, which is in international waters. Sub-area XII covers a vast area of the northeastern Atlantic that includes large parts of the Mid-Atlantic and Reykjanes Ridges. Whilst it may be reasonable to assume a stock separation between the slopes of the Rockall Trough and Mid-Atlantic Ridges, the Hatton Bank probably has more affinity with the Rockall area. However, a proportion of the landings from Sub-area XII cannot be readily attributed to the Hatton Bank and are therefore excluded by the ICES Study Group from the assessments of the Rockall area. While it would be desirable to reconfigure some existing ICES areas so that they are biologically meaningful in terms of the distribution of deep-water species as suggested by Coggan (1997) it is unlikely that this will be a viable option in the short term.

6.3.1 Categories of Deep-water species

Following Koslow (1996) two different categories of deep water species can be defined:

- widespread species that occur at relatively low density in almost any location of their geographical distribution. The roundnose grenadier (*C. rupestris*) is a typical species of this category;
- seamount (or other topographic or hydrographic feature) associated species that form dense aggregations in some particular habitats or at some time and have a very low density elsewhere.

In addition to their distribution pattern, at least, some "seamount associated" species have a different metabolism in consequence of adaptation to a particular life strategy, which allows for high local fish density in the food-limited deep-water environment. The aggregating characteristic of these species make them particularly vulnerable to fishing as high catch rates can be obtained from very small populations. Local aggregations can be fished down. In order to prevent the depletion of local populations, the proper management of such species should be at "seamount" scale. It is unlikely that each seamount is an independent genetic population as exchanges may occur in the larval, juveniles, adults or all stages.

However, from a demographic point of view, the likely low rate of exchange could explain the observed local depletion. For orange roughy, the fishery collapsed in Sub-area VI and not in VII (Lorance and Dupouy, 2001, ICES 2000b, Basson *et al.* in press). For blue ling, a spawning aggregation to the south of Iceland depleted in the early 1980s showed no sign of recovery 15 years later (Magnússon *et al.* 1997). The recovery from such local depletion, if not prevented by habitat alteration, may be a long process due to low recruitment of these species and their slow growth. For these species, maintaining the productivity of the whole stock probably requires each local aggregation to be kept at an adequate level.

6.3.2 Species/stock account

Greater Silver Smelt (*Argentina silus*)

The following account is from the 1998 report of ICES SGDEEP. Icelandic life history studies suggest that a separate stock might exist in Sub-area Va. Irish investigations on stock discrimination in areas VI and VII are inconclusive. A study by Ronan *et al.* (1993), using morphometrics (box truss analysis) and meristic measurements, suggests that populations from the north of Sub-area VI and the south of Sub-area VII form either end of a shape cline with fish in intermediary populations exhibiting a mixture of northern and southern morphologies. Norwegian investigations in 1984–1987 in Divisions IIa, IIIa and IVa appear to show two separate populations in the winter but in the summer the species is widely distributed (Bergstad, 1993).

Ling (*Molva molva*)

The following summary is from the reports of ICES Study Group on the Biology and Assessment of Deep-sea Fishery Resources (ICES; 1998, 2000b). The relevant information on stock structure has been discussed in reports of Norwegian and Nordic projects (Bergstad and Hareide 1996; Magnússon *et al.* 1997). Ripening adult ling and ling eggs have been found in all parts of the distribution area of the ling, but the banks to the west and north of Scotland and around Iceland and the Faroes seem to be the most important spawning areas. There may well be egg and larval drift among all these areas, probably with a net northward and eastward transport. Nothing is known about subsequent migrations within the area of distribution. In recent Norwegian studies of enzyme and haemoglobin frequencies, characters with sufficient variation to study spatial differences could not be found (Bergstad and Hareide 1996). There is currently no evidence of genetically distinct populations within the ICES area. However, ling at widely separated fishing grounds may still be sufficiently isolated to be considered management units, i.e., stocks, between which exchange of individuals is limited and has little effect on the structure and dynamics of each unit. Since no quantitative data on migration exist, it is however, unclear which of the many fishing areas have units satisfying the criteria of

stocks. It is tentatively suggested that Iceland (Va), the Norwegian Coast (II), and the Faroes and Faroe Bank (Vb) have separate stocks, but that the existence of distinguishable stocks along the continental shelf west and north of the British Isles and the northern North Sea (Sub-areas IV, VI, VII and VIII) is less probable.

Blue ling (*Molva dypterygia*)

The species identity of blue ling has for long been subject to debate, two forms (*dypterygia* and *macrophthalmalma*) having been considered as different species or as sub-species of the same *Molva dypterygia*. They now have been defined as two species (<http://www.fishbase.org>) and the southern limit of *M. dypterygia* is expected to be around 51°N (Ehrich, 1983). Further south, the species *M. macrophthalmalma* is distributed in the Bay of Biscay, off Spain and Portugal and in the Mediterranean. In contrast to *M. dypterygia* it is not known to form dense spawning aggregations and is not a target of any fishery. Thus, Sub-area VII appears to be the southern limit of the distribution of the blue ling (*M. dypterygia*) population(s).

Biological investigations in the early 1980s suggested that at least two adult stock components were found within the area, a northern one in Sub-area XIV and Division Va with a small component in Vb, and a southern one in Sub-area VI and adjacent waters in Division Vb. However, the observations of spawning aggregations in each of these areas and elsewhere suggest further stock separation. This is supported by differences in length and age structures between areas as well as in growth and maturity. Egg and larval data from early studies also suggest the existence of many spawning grounds. The conclusion must be that the stock structure is uncertain within the areas under consideration. However, SGDEEP considered that because there were similar trends in the CPUE series from Division Vb and Sub-areas VI and VII, the blue ling from these areas could be treated as one unit (ICES 2000b).

Tusk (*Brosme brosme*)

Ripening adult tusk and tusk eggs have been found in all parts of the distribution area, but the banks to the west and north of Scotland, around the Faroes and off Iceland, as well as the shelf edge along mid and north Norway seem to be the most important spawning areas (Magnússon *et al.* 1997). Nothing is known about migrations within the area of distribution. In recent Norwegian studies of enzyme and haemoglobin frequencies no geographical structure could be found, hence it was concluded that tusk in all areas, at least of the North-east Atlantic, belong to the same gene pool (Bergstad and Hareide, 1996). ICES SGDEEP considered that the widely separated fishing grounds may support separate management units, i.e., stocks. It is tentatively suggested that Iceland (Va) and the Norwegian coast (I and II) have self-contained units, while the separation among possibly several stocks to the north and west of the British Isles is less clear (ICES 2000b).

Roundnose grenadier (*Coryphaenoides rupestris*)

When the North Atlantic fishery for roundnose grenadier began in the late 1960s it was found that the fish from the western Atlantic were small and immature. On the other hand fish caught off southeast Iceland were large and mature. This led Russian scientists to propose that the waters off the Canadian and Greenland slopes were the nursery and feeding grounds for the roundnose grenadier and the area from which the grown fish migrate to Iceland where they spawn. The eggs and larvae would then drift back to the nursery grounds with the prevailing currents. There have been various refinements of this hypothesis over the years and differences in the frequency of parasites and enzyme polymorphisms of fish from different areas have been cited as evidence for such a migration. Large, mature roundnose grenadiers are now known to occur in waters deeper than those exploited by commercial trawlers off Canada and therefore there is no longer a need to propose such a migration. As for the migration hypothesis, parasitological and genetic evidence has been used to support the idea of separate stocks. The subject of stock identification in roundnose grenadier is likely to remain controversial until the genetic polymorphisms of a sufficiently large number of fish can be studied (Gordon and Hunter, 1994).

ICES SGDEEP considered that roundnose grenadier in Sub-areas II (Norwegian fjords) and III (Skagerrak) may represent separate stock(s) due to the physical boundary of the Wyville Thomson Ridge and fjord sills. For other populations, the stock structure remains unclear. Some preliminary evidence to support this view results from a study of otolith microchemistry (Gordon *et al.*, 2001). The Study Group carried out assessment for Division Vb and Sub areas VI and VII combined implicitly considering these areas as a stock unit for this species. Sub-area XII was not included because catches in that area include catches from the Mid-Atlantic ridge and from the Western part of Hatton Bank. They cannot be re-allocated properly to each of these areas which are likely to support rather separated stocks units. Moreover, catches in Sub-area XII are likely to be significantly under-reported.

Roughhead grenadier (*Macrourus berglax*)

A study on the genetics of the stocks of *Macrourus berglax* in three areas (West Greenland, East Greenland and the Norwegian Sea) provided strong evidence that the roughhead grenadier population in the North Atlantic was not a single panmictic stock but was composed of stock units with their own gene pools (Katsarou and Naevdal, 2001).

Alfonsinos/golden eye perch (*Beryx splendens*)

The genetics of *Beryx splendens* was studied by Hoarau and Borsa, (2000). They concluded that there was no evidence for spatial genetic variation (stock differentiation) within geographic regions for this species. They found little genetic variation between populations located in the Atlantic and Pacific. However, Menezes et al. (2001) point out that only four samples were obtained from the Atlantic, and consider the Pacific and Atlantic populations to be strongly differentiated. They conclude that there is probably a higher degree of genetic differentiation between oceans than previously thought. However, within the Azorean region the results were inconclusive and requires a better level of sampling.

Orange roughy (*Hoplostethus atlanticus*)

The genetics of orange roughy on a global scale have recently been reviewed by Branch (2001). These studies, which are almost entirely based on the southern hemisphere, have produced equivocal results. Those that have focused on environmental characteristics depend on the surroundings of the fish during its life and have generally found differences between stocks. Examples are otolith microchemistry, otolith structure, morphometric differences and parasite analysis which have found significant differences among virtually every stock examined. The mean radius of the transition zone in orange roughy otoliths differed among New Zealand populations and these differed from Namibian and Hatton Bank (west of the British Isles) populations (Horn *et al.* 1998). All of these studies suggest that adult orange roughy are relatively sedentary, and that stocks are fairly isolated from one another.

Genetic studies have generally failed to discriminate between stocks. Restriction site analysis of mitochondrial DNA has been used with the most success to distinguish stocks at a global scale eg. between Pacific and Atlantic. Branch (in press) considers that “genetic data may have poor discriminatory power because of the extreme longevity (> 100 y) of orange roughy, which has two important consequences. First, genetic changes accumulate very slowly in long-lived species, and second, the number of migrants per year need only be extremely small to allow genetic divergence”.

Wreck fish (*Polyprion americanus*)

Wreckfish have a broad disjunct geographic distribution; juveniles are very rare in the western Atlantic but are common in the eastern Atlantic. There is also a different bathymetric distribution, juveniles are pelagic up to a length of 60cm and it is uncertain where and at what size they descend to bottom.

Studies of reproduction indicate that spawning occurs off the South Carolina, and unexploited stages are then dispersed to the eastern Atlantic via the Gulf Stream. Strong evidences on population structures of Blake Plateau, Azores, Madeira also supports this dispersion pattern cycle, moreover some doubts persists on the existence of a resident spawning population in the eastern Atlantic. Genetics studies based on data from Blake Plateau, Azores, Madeira; Mallorca and some other South Atlantic and Pacific areas indicated three composite types with a clear separation between northern and southern hemispheres. Genetic similarity between eastern and western Atlantic fish indicated gene flow between the Blake Plateau Azores, Madeira and the Mediterranean (Sedberry, et al.1999).

Red (blackspot) seabream, (*Pagellus bogaraveo*)

Information on red (blackspot) seabream, *P. bogaraveo*, has been split into three different *P.* components, as referred to in the 1996 and 1998 reports of SGDEEP (ICES 1996, 1998):

- *P. bogaraveo* in Sub-areas VI, VII and VIII
- *P. bogaraveo* in Sub-area IX
- *P. bogaraveo* in Sub-area X (Azores region)

This separation does not pre-suppose that there are three different stocks of *P. bogaraveo*, but it offers a better way of recording the available information. In fact, the inter-relationships of the red seabream from the Sub-areas VI, VII, VIII and the northern part of Division IXa, and their migratory movements within these sea areas have been confirmed in the past by tagging methods (Gueguen, 1974; ICES, 1996). A recent genetic study on red sea bream at the Azores

considered that the population in this area could be considered as a single stock. There was evidence of small gene flow between the Azores and the Portuguese mainland (Menezes et al., 2001, Stockley et al., 2000).

Tagging of mature red seabream has been carried out in the Azores and the Strait of Gibraltar and recoveries indicate that there were no important movements. However, juveniles tagged in the southern Mediterranean region moved to the Strait of Gibraltar. A few fish moved from the Strait of Gibraltar to the Mediterranean. This suggests an important link between Spanish South Atlantic and the Mediterranean red seabream populations.

Black Scabbardfish (*Aphanopus carbo*)

Research into stock discrimination was carried out during the BASBLACK EC Study Contract (Anon., 2000). The working hypothesis is that there is one stock extending from Faroe Islands to Madeira. The study involved genetics (DNA) and otolith micro-chemistry. Some genetic polymorphisms were identified but the results were inconclusive. The results of the whole otolith microchemistry were not conclusive (Swan et al., 2001). Some of the results from BASBLACK, namely length distribution and reproductive behaviour, are suggestive of migratory processes of components of the population.

Bluemouth (*Helicolenus dactylopterus*)

The genetic variation in the family Scorpaenidae was studied by Johansen *et al.* (1993). The samples of blue mouth were collected around Shetland and the Faroe Islands in 1990 and analysed by starch gel electrophoresis and isoelectric focusing of haemoglobin and tissue enzymes. Intraspecific variation was low in blue mouth.

Recent and preliminary data from tagging/recapture experiments of this species made in several and sparse places in the Azores indicate no movements and a very sedentary behaviour. This could suggest the existence of separated populations in the North Atlantic that may be related to topographical barriers.

Deep-water sharks

There is little information on stock identification in deep-water sharks, rays or chimaeras. Few genetic studies have been carried on deep-water chondrichthyans. One study considered the quantitative genetics of vertebrae and dorsal finspines in the velvet belly shark *Etmopterus spinax* (Tave, 1984). However there are some data that support the view that deep-water sharks are highly migratory. Clark and King (1989) found that smallest *Deania calceus* associated with large females in waters to about 800 m, and a progressive increase in their numbers moving west to east around North Island New Zealand indicating a cyclical migration around the north island. In addition it may be likely that breeding aggregations are localised, as suggested by Clark and King (1989). The continental slopes of Portugal are populated by *Deania calceus* of smaller size (Machado and Figueiredo, 2000) than those present west of Ireland or Scotland (Clarke et al. 2001). Gravid females *Centrophorus squamosus* have been recorded in Madeira and Portugal. However there are no records of any gravid female from west of Ireland or Scotland despite intensive sampling (Girard and Du Buit, 1999), where less than 15 % of female *Centrophorus squamosus* were mature. This may indicate a north-south migration in this species, similar to that known to occur off southern Japan.

6.4 Discards

Since the end of the EC FAIR 95-0655 project (Gordon, 1999), many of the discard sampling programs initiated under that project have been discontinued or continued only on an opportunistic basis. Only France and Spain now have continuous and regular discard sampling programs. Several countries have contributed new discard data, however the format in which this data is presented varies greatly e.g. percentage occurrence of species in discards, percentage of each species discarded or retained, numbers or weights discarded per hour trawling or per long line hook. It is the opinion of the group that progress should be made towards the development of a common discard reporting format; this should aid progress towards the incorporation of discard data in future assessments.

Because of the typically low level of sampling that has been undertaken and the great heterogeneity of some fisheries in terms of fishing depth etc. it has not generally been possible to estimate with any confidence discarding at fleet level. This should be rectified in the case of the French fisheries by work currently being done by PROMA.

6.4.1 Newly reported data on discarding

France

Since June 2001, the fishermen's organization PROMA have collaborated with IFREMER to allow collection of data that is usually not available to scientists (Girard WD). Participating skippers make voluntary reports of discards on a haul-by-haul basis. Discards are reported by species except for two combined categories that have been created to avoid identification problems; mixed sharks and "Nez Pointus", an arbitrary grouping of species with similar morphology including *Trachrhynchus sp.*, *Coelorhynchus sp.*, *Nezumia aequalis*, *Coryphaenoides guentheri* and *Lepidion eques*. Results at the time of writing are preliminary but it is possible to give a breakdown of relative contribution of each category by depth (Table 6.11). For future working groups it should be possible to give total weight of discards by species raised to the level of the French fleet. The preliminary results appear to agree with the findings of Blasdale and Newton (1998) showing very high levels of discarding of blue whiting and greater argentine in the 300m to 800m depth range and of Baird's smoothhead between 700m and 1500m. Discards of species of commercial interest (of which about 80% is roundnose grenadier) are important at depths greater than 1300m

Figure 6.11 Preliminary results of discard studies by PROMA. Percentage discard in four species groups by depth range.

Depth range	Duration (minutes)	<i>Alepocephalidae</i>	"Nez pointus" *see text 6.4.1	<i>Argentina silus</i> + <i>Micromesistius poutassou</i>	Discards of species that have a commercial interest
500	5020	74.07	0.00	16.67	9.26
600	13770	3.25	0.00	87.66	9.09
700	20360	51.64	2.18	40.73	5.45
800	28565	41.38	7.47	43.68	7.47
900	17840	83.08	8.84	0.00	8.08
1000	46200	95.78	1.48	0.00	2.74
1100	63845	91.52	1.45	0.35	6.68
1200	24675	87.65	2.63	0.00	9.72
1300	24400	62.40	6.86	0.00	30.73
1400	27255	52.02	7.96	0.00	40.01
1500	10060	39.60	5.12	0.00	55.28

Spain

Since the start of the commercial fishery in 1996 the Spanish Institute of Oceanography (IEO) has collected haul by haul data on weight discarded by species, position and depth through its observer program on the Spanish freezer trawler fleet operating on the Hatton bank (sub area XII and division VIb). Data from 1996 to 1999 are presented in Durán Muñoz *et al.* 2001. New data for 2000 and 2001 are presented in tables 6.12 and 6.13. Of particular note is the low degree discarding by the Spanish freezer fleet of species normally discarded by other fleets e.g. Baird's smoothhead (3% to 8% discard) (Durán Muñoz WD)

During 1999 and 2000 a survey on quarterly basis was conducted by AZTI and IEO (EU DG XIV Study Contract N° 98/095) with observers on board of Spanish vessels to study the catch retentions and discards by different bottom trawl metiers in different ICES Sub-areas. Results for Deep-water species are presented in Table 6.14. These results must be considered with caution due to the various reasons for discarding. There is a great variability in the percentage of retention and discard for each metier, and yet from each fishing trip, sampled. The values obtained in 2000 certainly cannot be extrapolated to other metiers in the same area or to the same metier in different years (Lucio *et al.*, WD; Pérez N., pers. com.).

Table 6.12.- Spanish fishery on Hatton Bank. Estimated retained catch and discards by specie and year. %R= percentage retained, %D = Percentage discarded.

Species	Year 2000		Species	Year 2001(preliminary)	
	%R	%D		%R	%D
Blue ling	100	0	Blue ling	100	0
Mora	100	0	Geenland halibut	100	0
Portuguese dogfish	100	0	Portuguese dogfish	99	1
Geenland halibut	100	0	Black scabbardfish	98	2
Black scabbardfish	99	1	Baird's smoothhead	97	3
Cataetix laticeps	97	3	Cataetix laticeps	95	5
Leafscale gulper shark	97	3	Roundnose grenadier	93	7
Longnose velvet dogfish	95	5	Deep-water sharks various	90	10
Roundnose grenadier	93	7	Mora	89	11
Baird's smoothhead	92	8	Lanternsharks	74	26
Smoothhead n.s.	88	12	Rabittfishes	61	39
Blackdogfish	60	40	Blackdogfish	61	39
Grenadiers various	60	40	Longnose velvet dogfish	59	41
Lanternsharks	59	41	Leafscale gulper shark	59	41
Rabittfishes	58	42	Skates	52	48
Bird beak dogfish	40	60	Smoothhead n.s.	48	52
North atlantic codling	33	67	Lophius sp	44	56
Skates	28	72	Bird beak dogfish	43	57
Fishes various	3	97	Wolffishes	35	65
Roughsnout grenadier	1	99	North atlantic codling	33	67
Catsharks	0	100	Grenadiers various	18	82
Blue antimora	0	100	Fishes various	6	94
Wolffishes	0	100	Roughsnout grenadier	1	99
Orange roughy	0	100	Greenland shark	0	100
Deep-water sharks various	0	100	Catsharks	0	100
Tusk	-	-	Blue antimora	0	100
Cardinalfish	-	-	Orange roughy	0	100
Lophius sp	-	-	Tusk	0	100
Greenland shark	-	-	Cardinalfish	0	100

Table 6.13.- Spanish fishery on Hatton Bank . Composition of the discards in weight.

Year 2000		Year 2001(preliminary)	
Species	% in weight	Species	% in weight
Roundnose grenadier	35	Roughsnout grenadier	35
Baird's smothhead	28	Roundnose grenadier	31
Roughsnout grenadier	17	Baird's smothhead	11
North atlantic codling	5	North atlantic codling	4
Other species	14	Other species	20

Table 6.14 Spanish fleet (AZTI and IEO data): Deep sea species retained and discarded catches by metier in 1999-2000.

1.- AZTI data (Lucio *et al.*, WD)

Metier 1: Bottom Otter "Baka" trawl in Div. VIIIh-j :: Mixed fishery :: Mesh size = 80 mm :: Year 2000 :: Annual values

Species	N° Discard.	C.V. Dis.	N° Retain.	C.V. Ret.	N° Total Catch	% Discard.	Weigth Discard.	Weigth Retain.
Greater Fork Beard (<i>Phycis blennoides</i>)	228254	416	376760	351	605013	38	17897	52732
Ling (<i>Molva molva</i>)	7649	518	n.e.b.n		n.e.b.n	(35)	11943	22110
Red Sea Bream (<i>Pagellus bogaraveo</i>)			n.e.b.n		n.e.b.n	n.e.b.n		745
Blue-mouth (<i>Helicolenus dactylopterus</i>)			n.e.b.n		n.e.b.n	n.e.b.n		172
Silver roughy (<i>Hoplostethus mediterraneus</i>)	9094938	181			9094938	100	344633	
Argentines (<i>Argentina spp.</i>)	1594587	269			1594587	100	74249	

Metier 2: Bottom Otter "Baka" trawl in Div. VIIIa,b,d :: Mixed fishery :: Mesh size = 65 mm :: Year 2000 :: Annual values

Species	N° Discard.	C.V. Dis.	N° Retain.	C.V. Ret.	N° Total Catch	% Discard.	Weigth Discard.	Weigth Retain.
Argentines (<i>Argentina spp.</i>)	599068	442	198887	461	797955	75	15201	5820

Metier 3: Bottom Pair trawl with VHVO nets in Div. VIIIa,b,d :: Targeted fishery :: Mesh size = 75 mm :: Year 2000 :: Annual values

Species	N° Discard.	C.V. Dis.	N° Retain.	C.V. Ret.	N° Total Catch	% Discard.	Weigth Discard.	Weigth Retain.
Ling (<i>Molva molva</i>)			n.e.b.n.		n.e.b.n.	0		3043
Argentine (<i>Argentina spp.</i>)	192863	245			192863	100	13415	
Greater Fork Beard (<i>Phycis blennoides</i>)	n.e.b.n.				n.e.b.n.	100	2793	

Metier 4: Bottom Pair trawl with VHVO nets in Div. VIIIc :: Mixed fishery :: Mesh size = 45-65 mm :: Year 2000 :: Annual values

Species	N° Discard.	C.V. Dis.	N° Retain.	C.V. Ret.	N° Total Catch	% Discard.	Weigth Discard.	Weigth Retain.
Argentine (<i>Argentina spp.</i>)			21507	686	21507	0		845
Baird's smoothhead (<i>Alopocephalus bairdi</i>)	384088	255			384088	100	12546	

*n.e.b.n.= not estimated by number

2.- IEO data (Nélida Pérez, *pers. com.*)

Spanish Baka Otter Trawl fishery targeting in megrim, anglerfish and hake: Sub-areas VI and VII. Second semester of 1999.

Species	N° Discard.	C.V. Dis.	N° Retain.	C.V. Ret.	N° Total Catch	% Discard.	Weigth Discard.	Weigth Retain.
Greater silver smelt (<i>Argentina silus</i>)	2539		0		2539	100	134762	0

Spanish Baka Otter Trawl fishery targeting in megrim, anglerfish and hake: Sub-areas VI and VII. Year 2000. Annual values

Species	N° Discard.	C.V. Dis.	N° Retain.	C.V. Ret.	N° Total Catch	% Discard.	Weigth Discard.	Weigth Retain.
Greater silver smelt (<i>Argentina silus</i>)	27665		0		27665	100	1316089	0

Spanish Baka Otter Trawl fishery targeting in hake, witch, Norway lobster and megrim. Sub-areas VI-VII. Second semester of 1999.

Species	N° Discard.	C.V. Dis.	N° Retain.	C.V. Ret.	N° Total Catch	% Discard.	Weigth Discard.	Weigth Retain.
Greater silver smelt (<i>Argentina silus</i>)	12084	119	0		12084	100	953386	0
Greater forkbeard (<i>Phycis blennoides</i>)	425	177	416	87	841	51	79710	186587
Blue ling (<i>Molva dipterygia</i>)	43	296	396	249	439	10	3211	142739

Table 6.14 continued. Spanish fleet (AZTI and IEO data): Deep sea species retained and discarded catches by metier in 1999-2000. (Continued)

Spanish Baka Otter Trawl fishery targeting in hake, witch, Norway lobster and megrim. Sub-areas VI-VII. Year 2000. Annual values

Species	N° Discard.	C.V. Dis.	N° Retain.	C.V. Ret.	N° Total Catch	% Discard.	Weigth Discard.	Weigth Retain.
Greater silver smelt (<i>Argentina silus</i>)	11223	174	0		11223	100	789304	0
Greater forkbeard (<i>Phycis blennoides</i>)	1053	162	527	101	1580	67	175822	264666
Blue ling (<i>Molva dipterygia</i>)	181	216	1129	450	1310	14	14462	448247

Spanish Baka Otter Trawl mixed fishery in Division VIIIc Central. Second semester of 1999.

Species	N° Discard.	C.V. Dis.	N° Retain.	C.V. Ret.	N° Total Catch	% Discard.	Weigth Discard.	Weigth Retain.
Lesser silvert smelt (<i>Argentina sphyraena</i>)	6	294	4	424	11	59,2	321	172
Roughnose rattai (<i>Trachyrhynchus trach.</i>)	3	na	0		3	100,0	279	0
Greater forkbeard (<i>Phycis blennoides</i>)	0		1	226	1	0,0	0	306

Spanish Baka Otter Trawl mixed fishery in Division VIIIc Central. Year 2000. Annual values

Species	N° Discard.	C.V. Dis.	N° Retain.	C.V. Ret.	N° Total Catch	% Discard.	Weigth Discard.	Weigth Retain.
Lesser silvert smelt (<i>Argentina sphyraena</i>)	3	600	0		3	100	151	0
Roughnose rattai (<i>Trachyrhynchus trach.</i>)	17						2250	0
Greater forkbeard (<i>Phycis blennoides</i>)	6	600	4	290	9	60	323	457

Spanish Baka Otter Trawl mixed fishery in Divisions VIIIc West and IXa. Second semester of 1999.

Species	N° Discard.	C.V. Dis.	N° Retain.	C.V. Ret.	N° Total Catch	% Discard.	Weigth Discard.	Weigth Retain.
Greater forkbeard (<i>Phycis blennoides</i>)	266	408	84	292	350	76	10151	16594
Lesser silvert smelt (<i>Argentina sphyraena</i>)	1280	264	99	673	1379	93	51434	3618
Dogfish (<i>Scyliorhinus canicula</i>)	1560	404	139	625	1699	92	219192	57635
Roughnose rattai (<i>Trachyrhynchus trach.</i>)	41	1017	0		41	100	2823	0

Spanish Baka Otter Trawl mixed fishery in Division VIIIc West and IXa. Year 2000. Annual values

Species	N° Discard.	C.V. Dis.	N° Retain.	C.V. Ret.	N° Total Catch	% Discard.	Weigth Discard.	Weigth Retain.
Greater forkbeard (<i>Phycis blennoides</i>)	805		263		1068	75	49000	71033
Lesser silvert smelt (<i>Argentina sphyraena</i>)	3986	308	578	314	4564	87	124993	21735
Roughnose rattai (<i>Trachyrhynchus trach.</i>)	321	587	0	0	321	100	29237	0

Spanish Pair Trawl targeting blue whiting Divisions VIIIc, IXa. Second semester 1999.

Species	N° Discard.	C.V. Dis.	N° Retain.	C.V. Ret.	N° Total Catch	% Discard.	Weigth Discard.	Weigth Retain.
Lesser silvert smelt (<i>Argentina sphyraena</i>)	6	294	4	424	11	59,2	321	172
Greater forkbeard (<i>Phycis blennoides</i>)	0		1	226	1	0,0	0	306
Roughnose rattai (<i>Trachyrhynchus trach.</i>)	3	na	0		3	100,0	279	0

Spanish Pair Trawl targeting blue whiting Divisions VIIIc, IXa. Year 2000. Annual values

Species	N° Discard.	C.V. Dis.	N° Retain.	C.V. Ret.	N° Total Catch	% Discard.	Weigth Discard.	Weigth Retain.
Lesser silvert smelt (<i>Argentina sphyraena</i>)	3	600	0		3	100	151	0
Greater forkbeard (<i>Phycis blennoides</i>)	6	600	4	290	9	60	323	457
Roughnose rattai (<i>Trachyrhynchus trach.</i>)	17						2250	0

Spanish High Vertical Bottom Trawl (VHVO) targeting horse mackerel. Divisions VIIIc, IXa. Year 2000. Annual values

Species	N° Discard.	C.V. Dis.	N° Retain.	C.V. Ret.	N° Total Catch	% Discard.	Weigth Discard.	Weigth Retain.
Lesser silvert smelt (<i>Argentina sphyraena</i>)	24		0		24	100	820	0

Since the end of EC FAIR 95-0655 further discard sampling was funded under the BASBLACK project (Anon., 2000), however since then, sampling by FRS Marine Laboratory has been sporadic. The results of discard sampling since 1996 in the French and Scottish fleets are presented in Tables 6.15 and 6.16. Further discard studies were completed following the sampling protocol developed by FRS as part of a PhD thesis by Paul Crozier at the University of the Highlands and Islands Millenium Institute/Dunstaffnage Marine Laboratory, and the data from these trips have been added into Table 6.17.

Since March 2002 FRS, with the cooperation of the Scottish Fishermen's Federation and a number of fishermen, has developed a deep-water logbook which it is hoped will be completed on a voluntary basis by a large proportion of the Scottish fleet fishing in deep water. This should provide continuous data on discarding as well as improved information on fishing depth, depth distribution of catches and effort expended in deep water for this fleet.

Table 6.15 Discards from French vessels landing in Scotland sampled by FRS Marine Laboratory (hauls at depths >500m)

+ - No weight data available

year	1997		1998		1999	
hours fishing on observed trips	183		369.3		290.8	
Number of observed trips	2		3		3	
	Discards		Discards		Discards	
	No/hour	Kg/hour	No/hour	Kg/hour	No/hour	Kg/hour
Ommastrephidae	0.3	0.16	1.9	0.82	0.28	0.24
<i>Apristurus laurussoni</i>	0.75	0.33	0.39	0.15	2.09	0.72
<i>Galeus melastomus</i>	0.27	0.19	0.08	0.05	0.91	0.46
<i>Galeus murinus</i>	0	0	0.54	0.1	0.88	0.27
<i>Scyliorhinus canicula</i>	0	0	0.02	0.03	0	0
<i>Squalus acanthias</i>	0.19	0.29	0	0	0	0
<i>Centrophorus squamosus</i>	0	0	0.02	0.7	0	0
<i>Dalatias licha</i>	0	0	0	0	0.04	0.1
<i>Etmopterus princeps</i>	0	0	0	0	2.48	2.99
<i>Etmopterus spinax</i>	0.09	0.03	1.21	0.08	0.1	0.06
<i>Oxynotus paradoxus</i>	0	0	0	0	0.11	+
<i>Centroscyllium fabricii</i>	2.01	2.54	1.7	1.09	4.48	5.04
<i>Centroscymnus coelolepis</i>	0.14	0.37	0.37	0.21	0	0
<i>Centroscymnus crepidater</i>	0.87	1.39	3.56	6.08	3.72	7.26
<i>Deania calceus</i>	2.19	5.14	1.31	3.12	2.14	5.76
<i>Raja spp</i>	0	0	0.09	+	0.13	+
<i>Raja hyperborea</i>	0	0	0	0	0.1	0.31
<i>Raja fyllae</i>	0.61	0.14	7.69	3.75	10.37	3.36
<i>Raja bathyphila</i>	0.36	+	0.08	+	0.18	+
<i>Raja kreffti</i>	0	0	0.08	+	0.13	+
<i>Raja kukujevi</i>	0.1	+	0.3	+	0.42	+
<i>Breviraja caerulea</i>	0.13	+	0.23	+	0.09	+
<i>Bathyraja spp</i>	0.32	+	0	0	0	0
<i>Hydrolagus mirabilis</i>	0.36	0.08	4.65	2.12	6.73	3.33
<i>Chimaera monstrosa</i>	10.42	9.52	8.69	6.78	9.54	5.32
<i>Rhinochimaera atlantica</i>	0	0	0	0	0.11	0.42
<i>Hariotta raleighana</i>	2.7	4.06	0.1	0.18	2.17	2.16
<i>Synaphobranchus kaupi</i>	0	0	0.43	<.01	0.69	0.05
<i>Serrivomer beani</i>	0.19	+	0	0	0	0
<i>Notacanthus chemnitzii</i>	0.1	0.24	0.37	0.56	0.84	2.68
<i>Argentina silus</i>	12.18	8.08	13.86	8.86	7.83	4.9
<i>Holtbyrnia anomala</i>	0	0	0	0	0.04	+
<i>Melanostomiidae</i>	0.02	0	0	0	0	0
<i>Chauliodus sloani</i>	0	0	0.05	+	0	0
<i>Alepocephalus rostratus</i>	0	0	0.05	0.1	0	0
<i>Alepocephalus bairdii</i>	58.03	105.89	74.75	126.53	102.09	248.13
<i>Xenodermichthys copei</i>	0.02	<.01	0	0	0.05	<.01

<i>Bathypterois dubius</i>	0.08	<.01	0	0	0	0
<i>Antimora rostrata</i>	0	0	0.15	0.03	0	0
<i>Mora moro</i>	0.08	0.04	0.27	0.18	0.06	0.03
<i>Lepidion eques</i>	7.78	1.34	66.44	10.93	75.72	12.44
<i>Halargyreus johnsonii</i>	0.49	0.03	2.29	0.17	3.32	0.31
<i>Phycis blennoides</i>	0.34	0.16	0.97	0.35	0.57	0.22
<i>Molva dypterygia</i>	0.17	0.13	0.16	0.16	0	0
<i>Micromesistius poutassou</i>	0.42	0.07	1.4	0.27	0.62	0.1
<i>Antonogadus macrophthalmus</i>	0	0	0.22	0.12	0	0
<i>Merluccius merluccius</i>	0	0	0.01	<.01	0	0
<i>Cataetyx laticeps</i>	0.19	0.1	0	0	0	0
<i>Lycodes spp</i>	0	0	0	0	0.07	+
<i>Melanostigma atlanticum</i>	0	0	0.08	<.01	0	0
<i>Coryphaenoides rupestris</i>	94.53	40.51	65.59	34.17	118.31	49.69
<i>Coryphaenoides guentheri</i>	0	0	0.3	0.02	4.7	0.47
<i>Chalinura mediterranea</i>	0	0	0	0	2.75	0.47
<i>Coelorhynchus coelorhynchus</i>	0.04	0.02	0	0	0.1	0.01
<i>Coelorhynchus labiatus</i>	8.07	0.8	3.48	0.31	18.99	2.03
<i>Malacocephalus laevis</i>	0	0	0.01	<.01	0.64	0.04
<i>Nematonurus armatus</i>	0	0	0.19	+	0	0
<i>Nezumia aequalis</i>	0.03	<.01	1.69	0.15	0.4	0.02
<i>Trachyrhynchus murrayi</i>	70.38	9.34	13.15	2.09	62.44	10.73
<i>Macrourus berglax</i>	0.03	0.03	0	0	0.06	0.08
<i>Hoplostethus atlanticus</i>	0	0	0	0	0.38	0.06
<i>Neocyttus helgae</i>	0	0	0	0	1.15	0.37
<i>Sebastes viviparus</i>	0.39	0.11	0.02	<.01	3.63	0.83
<i>Helicolenus dactylopterus</i>	1.22	0.2	1.35	0.25	5.83	0.88
<i>Cottunculus microps</i>	0	0	0	0	<.01	+
<i>Cottunculus thomsonii</i>	1.13	0.52	2.29	0.61	1.2	0.36
<i>Paraliparis spp</i>	0	0	0	0	0.05	+
<i>Epigonus telescopus</i>	0	0	0.29	0.19	0.22	0.16
<i>Trachurus trachurus</i>	0	0	0	0	0.05	0.03
<i>Anarhichas denticulatus</i>	0.15	0.7	0.04	0.06	0	0
<i>Aphanopus carbo</i>	0.31	0.28	0.23	0.16	1.12	0.46
<i>Scomber scombrus</i>	0	0	0	0	<.01	<.01
<i>Centrolophus niger</i>	0.05	+	0.05	+	0.11	+
<i>Lepidorhombus whiffiagonis</i>	0.15	0.04	0	0	0	0
<i>Glyptocephalus cynoglossus</i>	0.7	0.14	0.67	0.16	0.34	0.09

Table 6.16 Discards from Scottish deep water trawlers sampled by FRS Marine Laboratory (hauls at depths >500m)

+ - No weight data available

Year	1996		1997		2001	
hours fishing on observed trips	69		224		90	
Number of observed trips	1		3		1	
	Discards		Discards		Discards	
	No/hour	Kg/hour	No/hour	Kg/hour	No/hour	Kg/hour
Ommastrephidae	0	0	0	0	4.4	4.55
<i>Apristurus laurussoni</i>	0.32	0.38	0	0	2.23	1.73
<i>Apristurus aphiodes</i>	0	0	0	0	0.07	0.04
<i>Galeus melastomus</i>	0.7	0.52	0.43	0.28	0.01	<.01
<i>Galeus murinus</i>	0	0	0	0	0.23	0.08
<i>Etmopterus princeps</i>	0	0	0	0	0.11	0.14
<i>Etmopterus spinax</i>	0	0	0	0	0.1	0.04
<i>Centroscyllium fabricii</i>	0	0	0	0	1.23	1.51
<i>Centroscymnus crepidater</i>	9.01	6.79	1.15	0.75	6.48	11.98
<i>Deania calceus</i>	2.09	5.18	0.17	0.58	1.49	4.04
<i>Raja spp</i>	0	0	0	0	0.07	+
<i>Raja fyllae</i>	8.67	5.09	0.38	0.2	0.76	0.2
<i>Raja kukujevi</i>	0	0	0	0	0.03	+
<i>Hydrolagus mirabilis</i>	0.49	0.12	0	0	10.08	4.58
<i>Chimaera monstrosa</i>	15.64	10.43	3.59	3.18	4.41	2.64
<i>Rhinochimaera atlantica</i>	0	0	0	0	0.02	0.18
<i>Hariotta raleighana</i>	0	0	0	0	0.18	0.29
<i>Synaphobranchus kaupi</i>	0.1	<.01	0	0	0	0
<i>Notacanthus chemnitzii</i>	0	0	0	0	0.69	2.09
<i>Notacanthus bonapartei</i>	0	0	0	0	0.22	0.07
<i>Argentina silus</i>	130.83	53.56	122.22	65.15	0.28	0.28
<i>Alepocephalus bairdii</i>	3.41	0.81	0	0	191.8	155.22
<i>Xenodermichthys copeii</i>	0	0	<.01	<.01	0	0
<i>Lophius piscatorius</i>	0	0	0.08	0.01	0	0
<i>Mora moro</i>	6.41	3.99	0	0	1.24	1
<i>Lepidion eques</i>	307.93	48.82	80.19	12.24	60.74	10.31
<i>Halargyreus johnsonii</i>	5.68	0.33	0.3	<.01	5.29	0.42
<i>Pollachius virens</i>	0	0	0.1	0.14	0	0
<i>Brosme brosme</i>	0.1	0.16	0.66	1.38	0	0
<i>Phycis blennoides</i>	6.25	4.31	35.96	12.88	0.21	0.14
<i>Molva dypterygia</i>	0.1	0.11	9.44	7.2	0	0
<i>Gadiculus argenteus</i>	0	0	0.33	<.01	0	0
<i>Micromesistius poutassou</i>	3.2	0.5	17.08	3.32	0.42	0.06
<i>Antonogadus macrophthalmus</i>	0	0	4.53	1.6	0	0
<i>Coryphaenoides rupestris</i>	11.84	6.84	3.07	1.78	79.64	35.67
<i>Coelorhynchus coelorhynchus</i>	0	0	0	0	0.09	<.01
<i>Coelorhynchus labiatus</i>	0	0	0	0	0.18	0.02
<i>Malacocephalus laevis</i>	0	0	0.02	<.01	0.11	0.03
<i>Nezumia aequalis</i>	6.49	0.47	0.92	0.09	1.82	0.1
<i>Trachyrhynchus murrayi</i>	0	0	0	0	4.88	0.68
<i>Helicolenus dactylopterus</i>	9.22	2.46	24.19	4.66	0	0
<i>Eutrigla gurnardus</i>	0	0	0.02	<.01	0	0
<i>Cottunculus thomsonii</i>	0	0	0	0	0.19	0.06
<i>Epigonus telescopus</i>	0.57	0.24	0.79	0.26	1.04	0.66
<i>Anarhichas denticulatus</i>	0.1	0.44	0	0	0.11	0.36
<i>Aphanopus carbo</i>	0	0	0	0	0.27	0.24
<i>Centrolophus niger</i>	0	0	0	0	0.03	+
<i>Lepidorhombus whiffiagonis</i>	0	0	0.97	0.27	0	0
<i>Glyptocephalus cynoglossus</i>	0.1	0.05	0.05	<.01	0	0

Table 6.17 Discards from French deep water trawlers landing in Scotland sampled by Paul Crozier, UHIMI/DML (hauls at depths >500m)

+ - No weight data available

Year	2000		2001	
Hours fishing on observed trips	447		93	
Number of observed trips	4		2	
	Discards		Discards	
	No/hour	No/hour	No/hour	No/hour
<i>Apristurus laurussoni</i>	0.12	0.15	0.7	0.39
<i>Galeus melastomus</i>	1.13	0.81	0.1	0.06
<i>Galeus murinus</i>	0.06	0.02	1.68	0.54
<i>Etmopterus princeps</i>	1.76	3.23	10.68	15.93
<i>Etmopterus spinax</i>	1.09	0.47	0.27	0.2
<i>Centroscyllium fabricii</i>	0.55	0.88	9.41	14.11
<i>Centroscymnus crepidater</i>	1.96	3.32	4.46	7.68
<i>Deania calceus</i>	1.06	3.28	3.15	9.04
<i>Raja fyllae</i>	2.91	1.1	0.23	0.1
<i>Hydrolagus mirabilis</i>	1.88	1.06	4.42	2.93
<i>Chimaera monstrosa</i>	10.81	4.2	13.88	11.37
<i>Hariotta raleighana</i>	0	0	14.94	14.28
<i>Argentina silus</i>	10.5	4.44	54.81	26.29
<i>Alepocephalus bairdii</i>	66.01	75.13	43.58	65.17
<i>Lepidion eques</i>	19.67	3.51	13.1	2.28
<i>Phycis blennoides</i>	0	0	0.15	0.05
<i>Molva dypterygia</i>	0	0	0.08	0.07
<i>Coryphaenoides rupestris</i>	48.8	25.48	331.34	116.1
<i>Trachyrhynchus murrayi</i>	21.94	4.76	82.17	14.25
<i>Helicolenus dactylopterus</i>	0.9	0.11	1.2	0.13

Ireland

A report on deep water fisheries commissioned by BIM contains the results of observer sampling of discards on board Irish vessels trawling and long lining in deep water. The report was not made available to the meeting in time for inclusion of new material but has been included in the inventory of existing discard data (Ch 6.4.2).

6.4.2 Inventory of existing discard data

A substantial amount of research has been carried out into deep water discarding, largely as a result of the EC FAIR project (Gordon, 1999), however much of this data remains unpublished or available only in grey literature sources. Due to the inconsistent format in which the data is presented, it has not been possible to pull it all together in a common reference collection. It has therefore been decided to present a comprehensive inventory of the discard data currently available in a variety of sources (Table 6.18).

Table 6.18. Available data on deep water fish discarding

Fishery	Area	Years covered	Institute	References
Scottish deep water trawlers	VIa	1996 & 1997	FRS	EC FAIR 1999 Blasdale & Newton, 1999
French trawlers landing in Scotland	VIa	1997 to 1999, 2001	FRS	EC FAIR 1999 Blasdale & Newton, 1998
French deep water trawlers	VI, VII	1996 & 1997	IFREMER	EC FAIR 1999 Allain, 1999 Dupouy et al. 1998
Irish deep water trawlers	VIa, VII	1996 to 2001	FRC	Connolly <i>et al.</i> , 1999 Clarke <i>et al.</i> , 1999 BIM 2002c
Irish long liners	VI, VII, XII	2000 To 2001	FRC	Clarke <i>et al.</i> , 2002 Clarke and Moore, 2002 IM 2002c
Irish exploratory trawl and long line	VI, VII	1996 to 1999	FRC	EC FAIR 1999 Connolly & Kelly 1996 Connolly & Kelly 1997 Kelly <i>et al.</i> , 1997 ICES wg deep 2000
Irish trawlers targeting orange roughy	VII	2001	BIM	BIM 2002c
Norwegian Logline fishery	IVa, IIa, Vb1, VIa, XIVb	1993 to 1997	Møre Research	EC FAIR 1999
Experimental trawling on Hatton Bank	XII	1998	Møre Research	Langedal and Hareide, 1998 Working document - WG DEEP 2000
Spanish (Basque country) Trawl fleet.	VIIIc, VIIIabd, VII	2000	AZTI	EU DGXIV 98/095
Spanish Trawl fleet.	VI, VII, VIIIc, IXa	1999 to 2000	IEO	EU DGXIV 98/095
Spanish freezer trawlers at Hatton bank	XII, VIb	1996-present	IEO	Duran et al 2001 Working document - WG DEEP 2002
Portuguese long line fishery	IXa	1997 & 1998	IPIMAR	EC FAIR 1999

6.5 Inventory of fish community data.

In the 2001 report of WGDEEP (ICES CM 2001/ACFM:23), a list of references to deep-sea fish community studies from many parts of the ICES area was provided. Apart from the new discard studies described in Ch 6.4, some of which comprise basic data for community analyses, no new references could be added this year.

8 BLUE LING (*MOLVA DYPTELYGIA*)

8.1 Catch trends

Table 8.1 gives the landings data for blue ling by ICES Sub-areas and Divisions as used by the Working Group. The most important Areas are VI, Vb, Va, II and XII, catches are intermediate in Areas XIV, IV and VII and catches are low in Areas X, III, VIII, I and IX. There is a general declining trend in total catches in the period 1988-1994 from 25 400 t to 9 600 t. From 1995 to 2001 the catches increased at a steady rate to a level of 16 200 t almost exclusively accounting for by Area VI where the effort has increased.

Landings from Sub-area I are very small and are by-catches in other fisheries. Landings from Division IIa are mainly catches in a gillnet fishery off mid-Norway. The landings declined from 3 500 t in 1988 to 1 000 t in 1993 and have since declined further to a very low level of 2-400 t in recent years. The relatively minor landings from Sub-areas III and IV are by-catches in trawl fisheries and have been declining in recent years.

In Division Va, blue ling has been taken mainly as a by-catch by trawlers engaged in the redfish and Greenland halibut fishery in recent years. Iceland takes most of the catches. During the years 1980-1984, a directed fishery for blue ling was carried out in a very limited area on spawning aggregations. No aggregation of spawning blue ling has been detected in this area since then and consequently the landings have declined from about 8 500 t in 1980 to a level of 2 000-3 000 t since 1985. In the most recent years the landings have declined further to

800-1 700 t and catches of blue ling must now exclusively be regarded as bycatch in other fisheries.

The total landings from Division Vb fluctuated between 5 000 and 10 000 t during the 1980s, but have declined since to about 2 300-2 900 t in recent years; with preliminary landings for 2001 of 1 700 t. Most of the catches are taken in the spawning time by trawlers; at other times blue ling is taken as by-catch as the effort moves to other areas/species in order to maintain catch rates. In recent years most of the catches have been taken by Faroese and French trawlers.

The landings from Sub-area VI peaked at about 13 000 t in 1985, but have since then declined to 4 000 t in 1994 and increased to 8 200 t in 2000. The preliminary landing figure for 2001 was 9 836 t. French trawlers used to take more than 95 % of the total catch but in the most recent years the share of the total catches by UK trawlers has increased considerably.

The landings from Sub-areas VII are very small as the blue ling is taken as by-catch in other fisheries only.

The landings from Sub-area XII peaked in 1993 at more than 3 300 t but have since declined. In then period 1994-2000 the catches fluctuated with out a trend with an average of 700 t. Preliminary landing figures for 2001 are 800 t. Faroese and French trawlers used to take most of the catch but in the most recent years Spanish vessels have taken the majority of the catches. There are reasons to believe that the reportings of landings to Sub-areas VI and XII are not consistent from year to year.

In 1993 the Icelandic fleet fished on aggregations of spawning blue ling in a small area on the Reykjanes ridge at the border between Sub-areas Va and XIV. This resulted in landings by Iceland of more than 3 000 t from Sub-area XIV. The French fleet fished in this area prior to the Icelandic fleet but information on landings are lacking. Landings have been very small in recent years.

8.2 Stocks

Biological investigations in the early 1980s suggested that at least two adult stock components were found within the area, a northern one in Sub-area XIV and Division Va with a small component in Vb, and a southern one in Sub-area VI and adjacent waters in Division Vb. However, the observations of spawning aggregations in each of these areas and elsewhere suggest further stock separation. This is supported by differences in length and age structures between areas as well as in growth and maturity. Egg and larval data from early studies also suggest the existence of many spawning grounds. The conclusion must be that the stock structure is uncertain within the areas under consideration.

However, in this year's assessment, based on a.o. similar trends in the CPUE series from Division Vb and Sub-areas VI and VII in 1988-1998, the blue ling from these areas were treated as one unit.

8.3 Catch-Effort Data

A French commercial tuning series, constructed as described in section 6.1.2, was used in the assessment (Table 8.2, Figure 8.1).

Two Spanish CPUE series were provided by Lucio *et al.* (WD 2002) for Sub-areas VI and VII, respectively (Figure 8.2).

Icelandic CPUE series were provided by Sigurdsson (WD 2002) for Sub-area Va. The survey index for fishable biomass of blue ling from the Icelandic groundfish survey has decreased by 50% since 1986 (Figure 8.3). For the trawler fleet the CPUE for blue ling has been declining since 1993 and was at its lowest in 2001 (Table 8.3, Figure 8.4), but 80% of the landings were from trawlers in that year. CPUE for the long-liners during the years of 1994-2001 does not show this decline (Table 8.4, Figure 8.5).

8.4 Length distribution, age composition, mean weight at age, maturity at age, natural mortality

Length distributions from Icelandic survey and landings of blue ling, provided by Sigurdsson (WD 2002) for Sub-area Va, show that the size has been decreasing in recent years (Figures 8.6-8.7).

Data on length distributions of Spanish landings were available for Division VIb in 2001 and Sub-area XII in 2000-2001 (Figures 8.8).

Data on age composition, mean weight at age and maturity at age were available for many Sub-areas but are not presented in the report due to the difficulties in ageing of this species.

No information was available on natural mortality (M). However, as an estimate of M is required for the DeLury constant recruitment model (see section 8.6), M was estimated using the relationship:

$$M = \text{LN}(100)/\text{maximum age}$$

The maximum age can be set at the age where 1% of a year-class is still alive. Based on Faroese and French age readings, it is not very wrong to assume the maximum age for blue ling is 30 years. Given this and the relationship above, M might be in the order of 0.15.

8.5 Biological parameters

Variable	Value	Source/comment
Longevity (years)	Approx. 30	Bergstad and Hareide 1996, Magnusson <i>et al.</i> 1997
Growth rate, K	No data	
Natural mortality, M	In the order of 0.15	Based on review by SGDEEP 2000.
Fecundity (absolute)	1-3.5 millions	Gordon and Hunter 1994
Length at first maturity	75-80 cm 80-85 cm	Moguedet 1988, Magnusson <i>et al.</i> 1997
Age at first maturity	6-7 7-8	Moguedet 1988, Magnusson <i>et al.</i> 1997

8.6 Assessment

For this assessment, a modified DeLury constant recruitment model and a Schaefer production model were attempted using total international catch data for Division Vb and Sub-areas VI and VII combined (1963-2001) and CPUE from the French trawl fishery (1985-2001) in these areas (see above) but the results were unreliable. The DeLury model fitted the data poorly for a range of assumptions of initial proportion of stock to virgin biomass and error models. Although the fit from Schaefer was reasonably good, estimates of the intrinsic rate of growth (r) were extremely high (0.9).

8.7 Comments on assessments

It is not understood why the results from DeLury and Shaefer are unreliable given that the landings and CPUE data used in the assessment are of reasonable length and show good contrast.

8.8 Management considerations

All available evidence from the trends in CPUE series indicates that blue ling in Divisions Va and Vb and in Sub-areas VI and VII is at a low level. The length distributions from Divisions Va, Vb and Sub-areas VI and VII also indicate that the proportion of large fish in the landings has decreased in the most recent years. Using French trawl CPUE as an index of exploitable biomass, current exploitable biomass (U) at the end of 2001 is considered to be below U_{lim} (20% of virgin biomass).

Despite ACFM advice for no directed fisheries for this stock due to its severely depleted state, the WG group noted that not only were directed fisheries continuing but with increased effort in certain areas.

Table 8.1 Blue ling (*Molva dypterygia*). Working Group estimates of landings (tonnes)**Blue ling I**

Year	Iceland	Norway	Germany	Total
1988				
1989				
1990				
1991				
1992				
1993				
1994		3		3
1995	+	5		5
1996		+		+
1997	+	1		1
1998		1		1
1999		1		1
2000		3	+	3
2001*		1		1

*Preliminary.

Blue ling IIa and b

Year	Faroes	France	Germany	Greenland	Norway	E & W	Scotland	Total
1988	77	37	5	-	3,416	2	-	3,537
1989	126	42	5	-	1,883	2	-	2,058
1990	228	48	4	-	1,128	4	-	1,412
1991	47	23	1	-	1,408	-	-	1,479
1992	28	19	+	3	987	2	-	1,039
1993	-	12	2	3	1003	+	+	1,020
1994	-	9	2	-	399	9	-	419
1995	0	12	2	2	342	1		359
1996	0	8	1		254	2	2	267
1997	0	10	1		280	+		291
1998	0	3	+		272	+	3	278
1999	0	1	1		287	+	2	291
2000		2	4		240	1	2	249
2001*		6	+		190	1	2	199

*Preliminary.

Blue ling III

Year	Denmark	Norway	Sweden	Total
1988	10	11	1	22
1989	7	15	1	23
1990	8	12	1	21
1991	9	9	3	21
1992	29	8	1	38
1993	16	6	1	23
1994	14	4	+	18
1995	16	4		20
1996	9	3		12
1997	14	5	2	21
1998	4	2		6
1999	5	1		6
2000	13	1		14
2001*	20	4		24

*Preliminary.

Table 8.1 continued

Blue ling IVa

Year	Denmark	Faroes	France	Germany	Norway	E & W	Scotland	Ireland	Total
1988	1	13	223	6	116	2	2		363
1989	1	-	244	4	196	12	+		457
1990	+	-	321	8	162	4	+		495
1991	1	31	369	7	178	2	32		620
1992	1	-	236	9	263	8	36		553
1993	2	101	76	2	186	1	44		412
1994	+		144	3	241	14	19		421
1995	+	2	73	+	201	8	193		477
1996	+	0	52	4	67	4	52		179
1997	+	0	36	+	61	0	172		269
1998	+	1	31		55	2	191		280
1999	2		21	+	94	25	120	2	264
2000	2		15	1	53	10	46	2	129
2001*	7		9	+	75	7	145	9	252

*Preliminary. ⁽¹⁾ Included in VI.

Blue ling IVb

Year	France	E & W	Norway	Faroes	Denmark	Germany	Scotland	Total
1988		-						-
1989	2	-						2
1990	6	-						6
1991	7	-						7
1992	1	-						1
1993	0	3						3
1994	0	-	+	+				0
1995	3	3	+		+			6
1996	5	5	1		+			11
1997	1		+					1
1998	5		1					6
1999	(1)	1	0			+	+	1
2000	1					+		1
2001*	0				+	+	+	0

*Preliminary.

Blue ling IVc

Year	E & W	Norway	Total
1988	-	-	-
1989	-	-	-
1990	-	-	-
1991	-	-	-
1992	-		-
1993	-	-	-
1994	3		3
1995	-	-	-
1996			-
1997			-
1998			-
1999		0	-
2000			-
2001			-

*Preliminary.

Table 8.1 continued**Blue ling Va**

Year	Faroes	Germany	Iceland	Norway	E & W	Scotland	Total
1988	271	-	1,893	7			2,171
1989	403	-	2,125	5			2,533
1990	1,029	-	1,992	-			3,021
1991	241	-	1,582	1			1,824
1992	321	-	2,584	1			2,906
1993	40	-	2,193				2,233
1994	89	1	1,542				1,632
1995	113	3	1,519	-			1,635
1996	36	3	1,284				1,323
1997	25	+	1,319				1,344
1998	59	9	1,086				1,154
1999	31	8	1,525	8	8	3	1,583
2000	36	7	1,605	25	7	+	1,680
2001*	69	12	753	49	1	1	885

*Preliminary.

Blue ling Vb₁

Year	Faroes	France ⁽³⁾	Germany ⁽²⁾	Norway	E & W	Scotland ⁽¹⁾	Ireland	Russia	Total
1988	3,487	3,036	49	94	-				6,666
1989	2,468	1,800	51	228	-				4,547
1990	946	3,073	71	450	-				4,540
1991	1,573	1,013	36	196	1				2,819
1992	1,918	407	21	390	4				2,740
1993	2,088	192	24	218	19				2,541
1994	1,065	147	3	173	-				1,388
1995	1,606	588	2	38	4				2,238
1996	1,100	301	3	82	+				1,486
1997	778	1,656	+	65	11				2,510
1998	1,026	1,411	0	24	1				2,462
1999	1,730	1,068	4	38	4				2,844
2000	1,561	575	1	163	33			1	2,334
2001*	1,547	344	4	130	8		2		2,035

*Preliminary. ⁽¹⁾ Included in Vb₂. ⁽²⁾ Includes Vb₂ ⁽³⁾ Reported as Vb.**Blue ling Vb₂**

Year	Faroes	Norway	Scotland ⁽¹⁾	E & W	Total
1988	2,788	72	-		2,860
1989	622	95	-		717
1990	68	191	-		259
1991	71	51	21		143
1992	1,705	256	1		1,962
1993	182	22	91		295
1994	239	16	1		256
1995	162	36	4		202
1996	42	62	12		116
1997	229	48	11		288
1998	64	29	29		122
1999	15	49	24		88
2000	107	37	37		181
2001*	147	69	63	1	280

*Preliminary. ⁽¹⁾ Includes Vb₁.

Table 8.1 continued

Blue ling VIa

Year	Faroes	France	Germany	Ireland	Norway	Spain ⁽¹⁾	E & W	Scotland	Total
1988	14	6,614	2	-	29		2	1	6,662
1989	6	7,382	2	-	143		-	+	7,533
1990	-	4,882	44	-	54		-	1	4,981
1991	8	4,261	18	-	63		1	35	4,386
1992	4	5,483	4	-	129		-	24	5,644
1993	-	4,311	48	3	27		13	42	4,444
1994	-	2,999	24	73	90	433	1	91	3,711
1995	0	2,835	+	11	96	392	34	738	4,106
1996	0	4,115	4		50	681	9	1407	6,266
1997	0	3,845	+	1	29	190	789	1,021	5,875
1998	0	4,644	3	1	21	142	11	1,416	6,238
1999	0	3,730	+	10	55	119	5	1,105	5,024
2000		4,441	94	9	102	57	24	1,300	6,027
2001*		2,550	6	52	117	1,009	116	2,136	5,986

*Preliminary. ⁽¹⁾ Includes VIb

Year	Faroes	France	Germany	Norway	E & W	Scotland	Iceland	Ireland	Estonia	Total
1988	2,000	499	37	42	9	14				2,601
1989	1,292	61	22	217	-	16				1,608
1990	360	703	-	127	-	2				1,192
1991	111	2,482	6	102	5	15				2,721
1992	231	348	2	50	2	14				647
1993	51	373	109	50	66	57				706
1994	5	89	104	33	3	25				259
1995	1	305	189	12	11	38				556
1996	0	87	92	7	37	74				297
1997	138	331		6	65	562	1			1,103
1998	76	469		13	190	287	122	11		1,168
1999	204	690	⁽²⁾	9	168	2411	610	4		4,096
2000	+	508		184	500	966		7		2,165
2001*		202	1	256	1499	1803		4	85	3,850

*Preliminary. ⁽¹⁾ Includes XII. ⁽²⁾ Included in VIa.

Blue ling VIIa

Year	France ⁽¹⁾	UK (Scot)	Total
1988	-	-	-
1989	-	-	-
1990	-	-	-
1991		1	1
1992		-	-
1993		-	-
1994		-	-
1995		-	-
1996			
1997			
1998			
1999			
2000			
2001*			

Table 8.1 continued

Blue ling VIIb,c

Year	France	Germany	Ireland	Norway	Spain ⁽¹⁾	E & W	Scotland	Total
1988	21	1	-	-	-	-	-	22
1989	269	-	-	2	-	-	-	271
1990	177	-	-	-	-	-	-	177
1991	157	-	-	-	-	-	-	157
1992	126	-	-	3	-	-	6	135
1993	106	-	-	2	-	11	28	147
1994	100	-	1	1	-	6	22	130
1995	95	-	3	-	-	3	11	112
1996	118	-	-	1	-	15	57	191
1997	113	-	0	2	-	36	3	154
1998	157	-	-	1	-	60	6	224
1999	36	-	3	1	-	24	7	71
2000	45	1	45	5	-	9	2	107
2001*	31	+	169	5	-	16	3	224

*Preliminary. ⁽¹⁾ Included in VIIg-k

Blue ling VIII,d,e

Year	France	Total
1988		0
1989	1	1
1990	0	0
1991	10	10
1992	15	15
1993	3	3
1994	8	8
1995	4	4
1996	4	4
1997	1	1
1998	3	3
1999		
2000		
2001*		

*Preliminary.

Blue ling VIIg-k

Year	France ⁽¹⁾	Germany	Spain ⁽¹⁾	E & W	Scotland	Ireland	Total
1988				-	-		
1989	21			-	-		21
1990	46			-	-		46
1991	44			-	-		44
1992	256			-	-		256
1993	164			5	2		171
1994	190		4	3	4		201
1995	56		13	40	5		114
1996	67		21	42	40		170
1997	65	8	0 ⁽²⁾	134	12	9	228
1998	92		22 ⁽²⁾	223	24	10	371
1999	40	2 ⁽²⁾	59 ⁽²⁾	144	11	24	280
2000	39	1	63 ⁽²⁾	22	15	30	170
2001*	41	2	59 ⁽²⁾	14	14	325	455

*Preliminary. ⁽¹⁾ Included in VIIb,c ⁽²⁾ Reported as VII.

Table 8.1 continued

Blue ling XII

Year	Faroes	France	Germany	Spain	E & W	Scotland	Norway	Iceland	Total
1988		263							263
1989		70							70
1990		5							5
1991		1147							1147
1992		971							971
1993	654	2591	90						3,335
1994	382	345	25						752
1995	514	47			12				573
1996	445	60		264		19			788
1997	1	1		411	4				417
1998	36	26		375	1				438
1999	156	17		943	8	43		186	1,353
2000		23		406	18	23	21	14	505
2001*		26		585	32	91	103	2	839

*Preliminary. ⁽¹⁾ Included in VIa

Blue ling XIV

Year	Faroes	France	Germany	Greenland	Iceland	Norway	E & W	Scotland	Spain	Total
1988	21	-	218	3	-	-	-	-	-	242
1989	13	-	58	-	-	-	-	-	-	71
1990	-	-	64	5	-	-	10	-	-	79
1991	-	-	105	5	-	+	45	-	-	155
1992	-	-	27	2	-	50	27	4	-	110
1993	-	390	16	-	3,124	173	21	1	-	3,725
1994	1	-	15	-	300	11	57	-	-	384
1995	0	-	5		117	+	16	3	-	141
1996	0	(1)	12			+	2	+	-	14
1997	1		1			+	2		-	4
1998	48					1	6		-	55
1999			+			1	7		-	8
2000	+				4		2		526	532
2001*							6		1,175	1,181

*Preliminary

Blue ling. Total landings by Subarea/division and grand total.

Year	I	II	III	III	IV	Va	Vb	VI	VII	XII	XIV	Total
1988	0	3,537	218	22	363	2171	9526	9263	22	263	242	25409
1989	0	2,058	58	23	459	2533	5264	9141	293	70	71	19912
1990	0	1,412	64	21	501	3021	4799	6173	223	5	79	16234
1991	0	1,479	105	21	627	1824	2962	7107	212	1147	155	15534
1992	0	1,039	27	38	554	2906	4702	6291	406	971	110	17017
1993	0	1,020	16	23	415	2233	2836	5150	321	3335	3725	19058
1994	3	419	15	18	424	1632	1644	3970	339	752	384	9585
1995	5	359	5	20	483	1635	2440	4662	230	573	141	10548
1996	0	267	12	12	190	1323	1602	6563	365	788	14	11124
1997	1	291	1	21	270	1344	2798	6978	383	417	4	12507
1998	1	278		6	286	1154	2584	7406	598	438	55	12806
1999	1	291	+	6	265	1583	2932	9120	351	1353	8	15910
2000	3	249		14	130	1680	2514	8192	277	505	532	14096
2001*	1	199		24	252	885	2315	9836	679	839	1181	16211

*Preliminary

Table 8.2 Blue ling. CPUE data used for assessment: total catch, total effort and CPUE of the reference fleet, total international catch and SGDEEP2000 directed CPUE.

ICES sub-area	Year	Total international catch (t)	Data for the reference fleet			
			SGDEEP2000 cpue (kg/h)	WGDEEP02		
				Catch (t)	effort (h)	cpue (kg/h)
Vb	1985		696	2014	5461	369
Vb	1986		715	2307	3216	717
Vb	1987		531	3108	5620	553
Vb	1988	9526	393	2990	7102	421
Vb	1989	5264	280	1793	7216	248
Vb	1990	4799	210	1603	9354	171
Vb	1991	2962	136	415	4320	96
Vb	1992	4702	125	168	2321	72
Vb	1993	2836	100	87	1137	77
Vb	1994	1644	128	139	1288	108
Vb	1995	2440	178	316	1992	159
Vb	1996	1602	120	156	2053	76
Vb	1997	2798	140	390	3373	116
Vb	1998	2584	152	803	6105	132
Vb	1999	2932		941	10119	93
Vb	2000	2514		455	7961	57
Vb	2001	2315		303	10336	29
VI	1985		1341	2283	1657	1378
VI	1986		680	1646	4411	373
VI	1987		882	2478	5308	467
VI	1988	9263	599	2277	5339	426
VI	1989	9141	446	2344	5702	411
VI	1990	6173	319	1294	5521	234
VI	1991	7107	359	2042	8634	237
VI	1992	6291	210	678	8373	81
VI	1993	5150	191	809	9088	89
VI	1994	3970	151	835	9222	91
VI	1995	4662	158	1042	10129	103
VI	1996	6563	119	1056	11244	94
VI	1997	6978	157	1116	10028	111
VI	1998	7406	144	1271	9347	136
VI	1999	9120		945	6027	157
VI	2000	8192		1942	9914	196
VI	2001	10599		500	5702	88
Combined	1985		898	4297	7645	905
Combined	1986		732	3953	7751	574
Combined	1987		659	5586	10928	515
Combined	1988	18811	471	5267	12551	423
Combined	1989	14698	337	4137	12953	341
Combined	1990	11195	255	2897	14896	200
Combined	1991	10281	226	2485	16061	210
Combined	1992	11399	170	882	19576	76
Combined	1993	8307	154	928	15891	85
Combined	1994	5953	130	1013	18205	90
Combined	1995	7332	150	1407	18522	112
Combined	1996	8530	105	1255	17339	89
Combined	1997	10159	124	1537	16086	110
Combined	1998	10588	111	2113	18528	132
Combined	1999	12403		1917	19138	125
Combined	2000	10983		2416	20490	171
Combined	2001	13593		823	18105	67

Data from Sub-area VII are very small and are not presented in the table. However, they have been included in the combined data in the table

Table 8.3. Blue ling. Registered catch, hours trawled and CPUE from the Icelandic trawler fleet. Tows used for calculations are those where blue ling was more than 10% of total catch in each particular haul.

year	catch (t)	hours	cpue (kg/h)
1991	515	963	534
1992	643	1197	537
1993	3587	2805	1279
1994	659	1571	419
1995	406	1135	357
1996	185	764	242
1997	186	924	201
1998	267	1015	263
1999	711	2048	347
2000	236	1485	159
2001	132	979	135

Table 8.4. Blue ling. Effort (number of hooks *1000) and cpue for blue ling, as calculated from the Icelandic long-line logbook data.

Year	Effort	CPUE (g/hook)
1994	269	14.9
1995	840	21.8
1996	586	59.4
1997	236	40.9
1998	64	26.9
1999	809	99.4
2000	619	103.0
2001	265	50.1

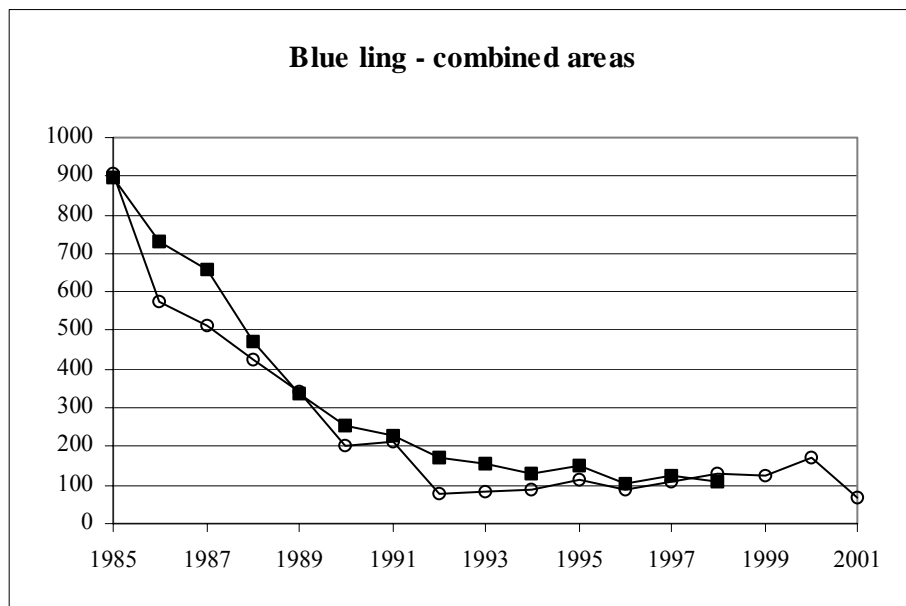

Figure 8.1. Blue ling in Division Vb and Sub-areas VI-VII combined. CPUE from directed catch and effort in 1985-1998 (closed squares) and total catch and effort 1985-2001 (open circles) of French trawlers.

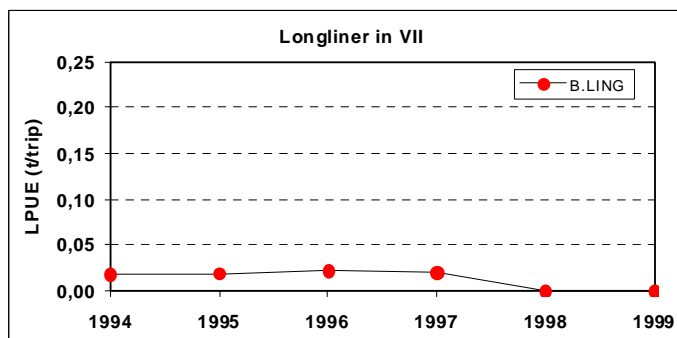
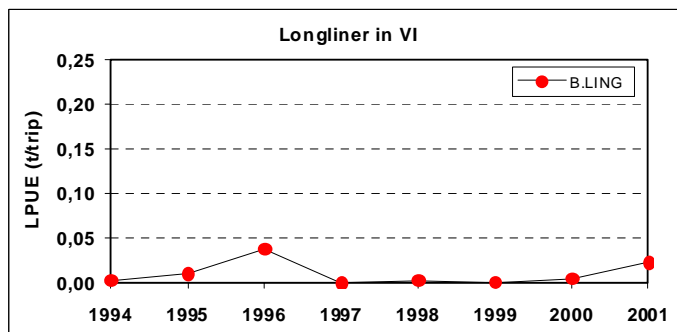
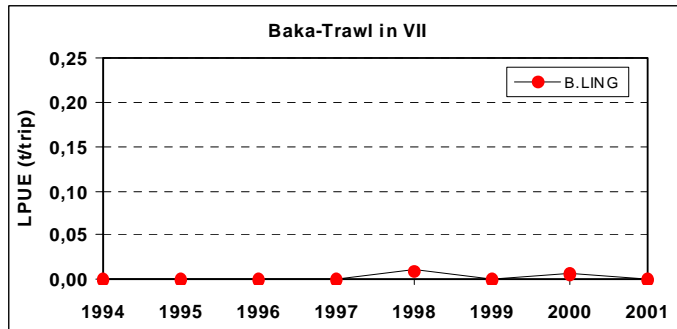
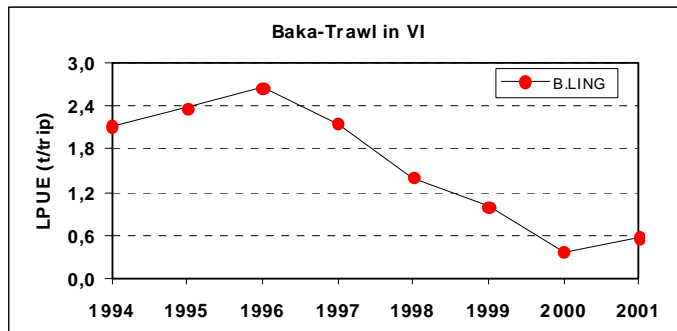

Figure 8.2. Landings per fishing effort (LPFE: tones/trip) of Blue ling in ICES Sub-area VI and VII, of "Baka" trawlers and longliners of the Basque Country, in 1994-2001. (Data on 2001 are preliminary).

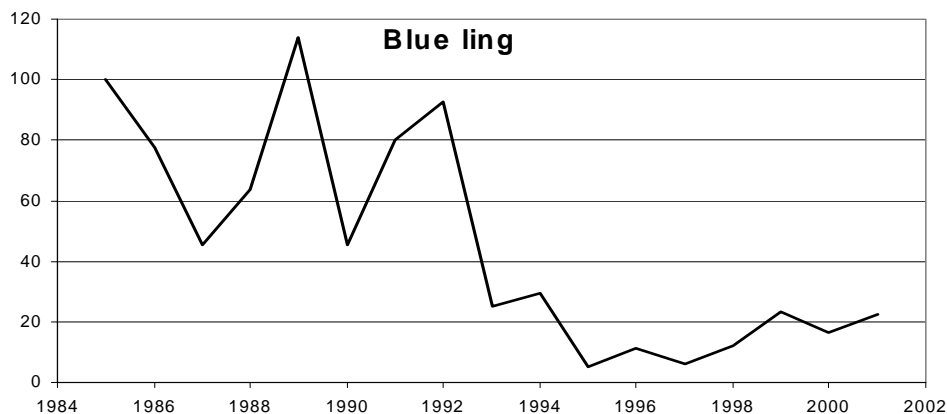

Figure 8.3. Blue ling. Index on fishable biomass calculated form the Icelandic groundfish survey at the Icelandic shelf.

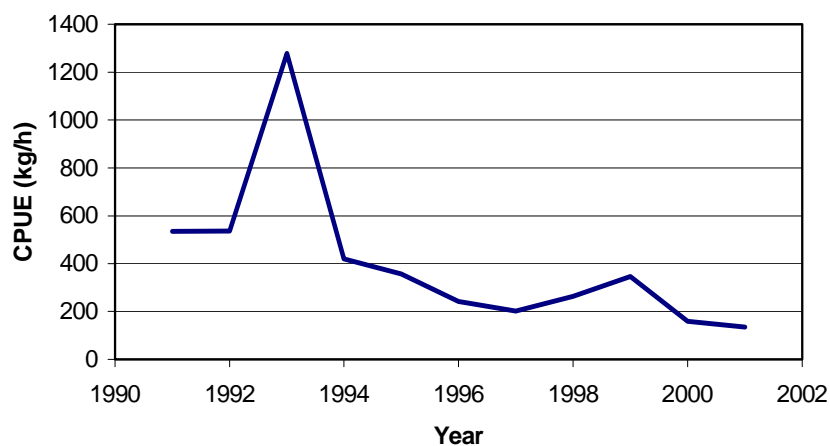

Figure 8.4. Blue ling catch per unit off effort calculated from the Icelandic trawl fishery.

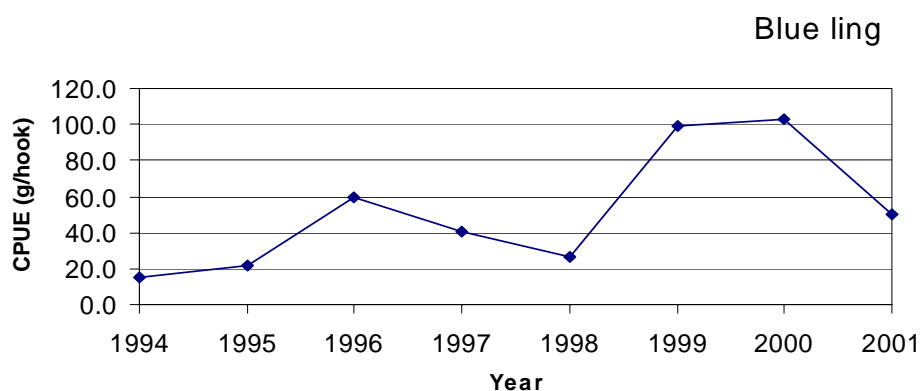

Figure 8.5. Blue ling catch per unit of effort calculated from the Icelandic long-line fishery.

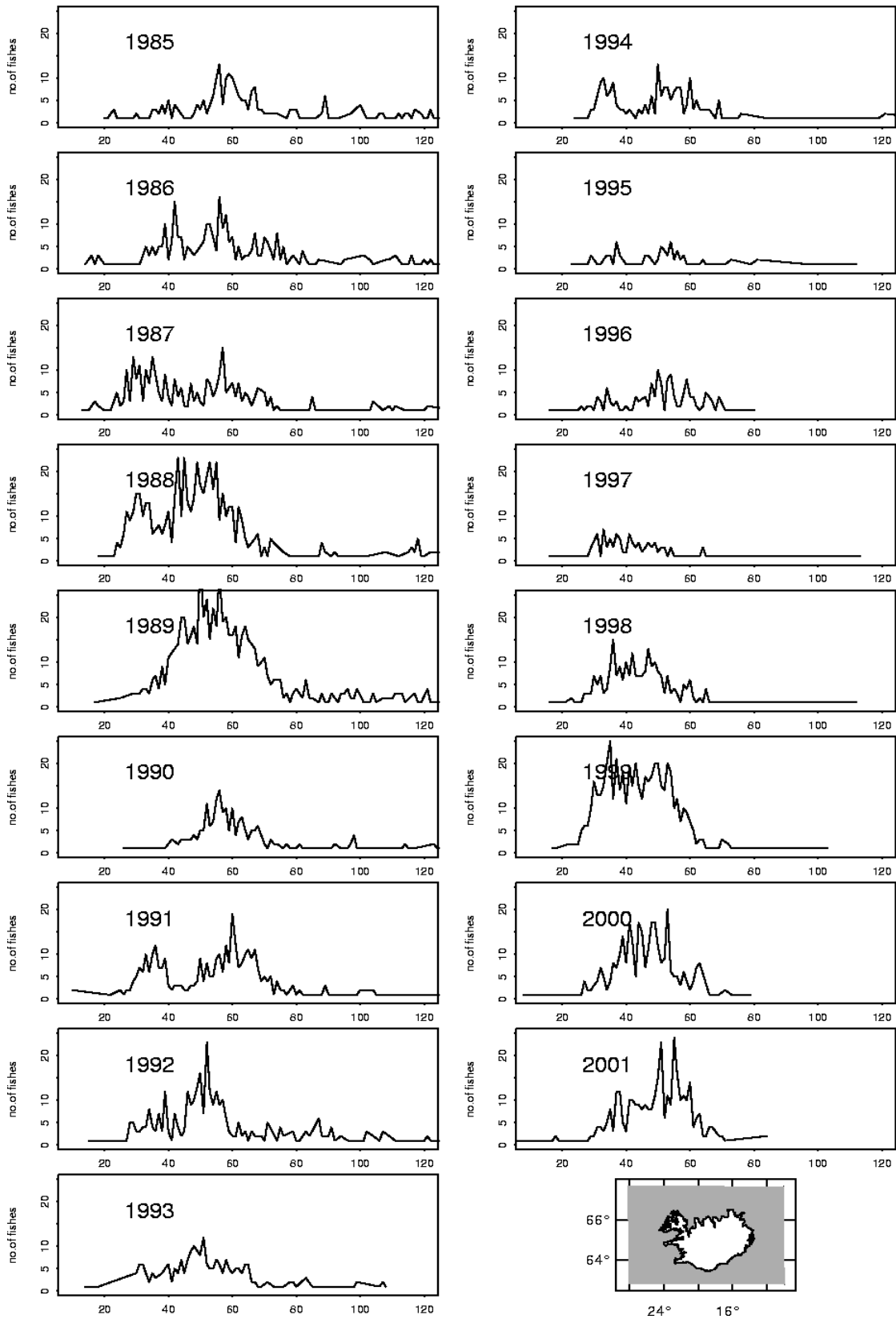
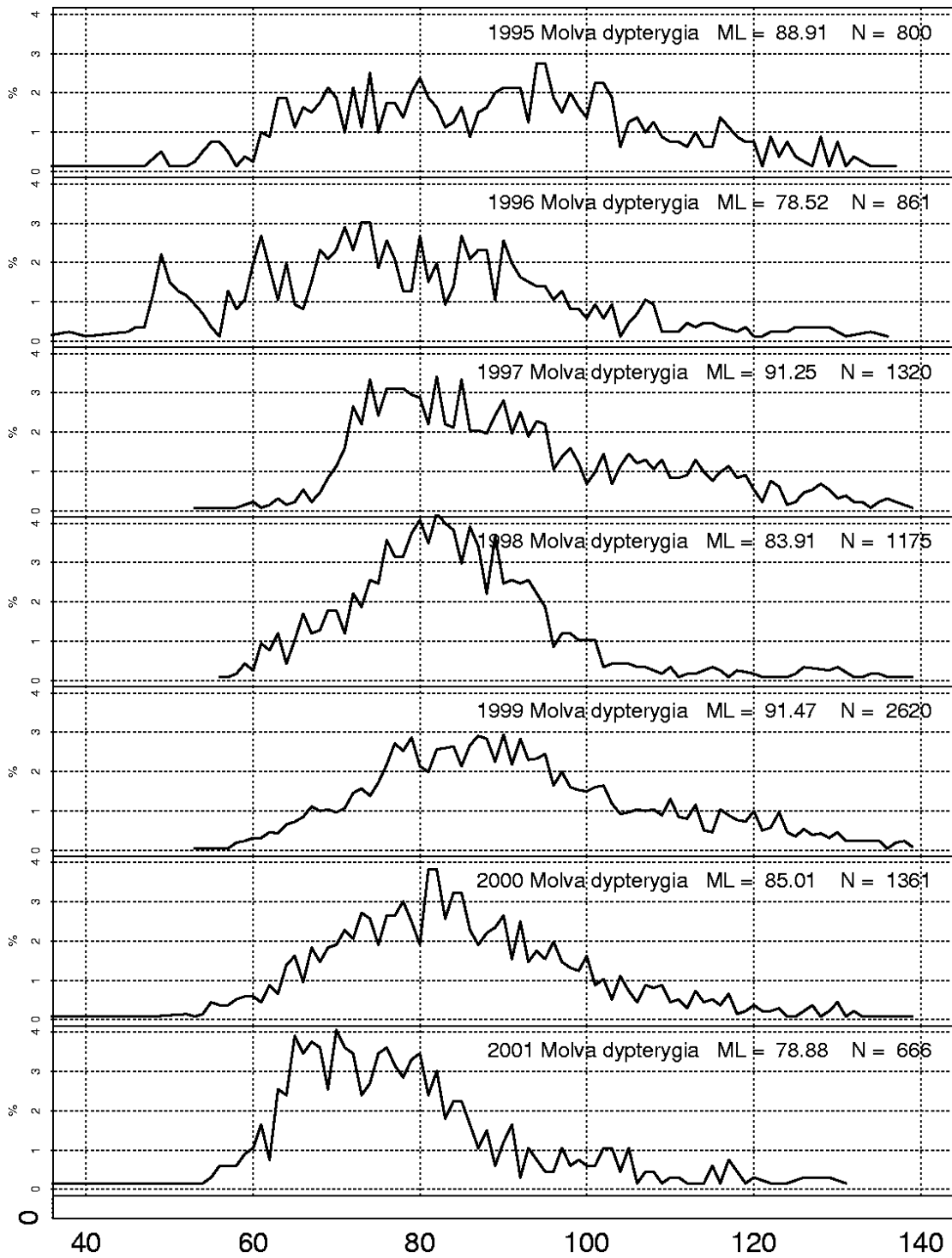

Figure 8.6. Blue ling length distributions in the Icelandic groundfish survey in March 1985-2001.



ldist.7.ps

Figure 8.7. Length distribution of blue ling in the Icelandic commercial catches.

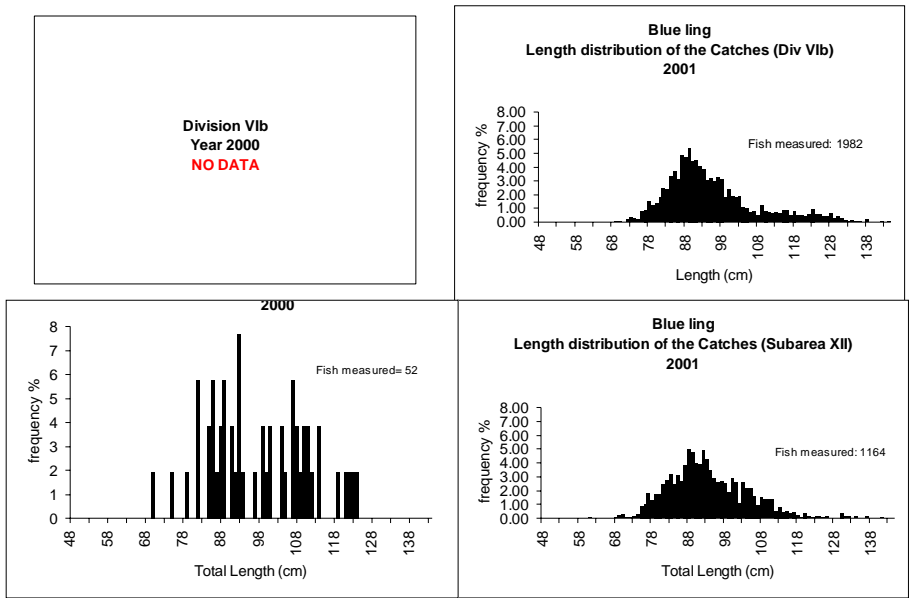

Figure 8.8. Length distribution of spanish catches in Division VIb in 2001 and Sub-area XII in 2000-2001.

9 TUSK (*BROSME BROSME*)

9.1 Catch Trends

The landings of tusk are given in Table 9.1.

In Division IIa the landings increased in 1998 and 1999 after a period with a decreasing trend from 1989 onwards. The total landings in 2000 and 2001 were 13,192 t and 11,290 t, respectively, which were lower than in previous years. There was also a decline in Sub-area I. The landings are almost entirely Norwegian, and in 2001 86.1% was taken by longlines and 11.4% by gillnets.

In Division IVa the landings in 2000 and 2001 were about 3,200 and 3,000 t which is at the level observed since 1994 but lower than the 4,000–6,500 t in 1988–1993. The bulk of the landings come from Norwegian fisheries, and around 90% of the landings are taken by longlines. The remainder of the landings from this area, and also the southern and central North Sea and Division IIIa, come from various trawl fisheries.

In Va and Vb landings increased in the period 1989–1991 but decreased again in 1994–1998. The Va landing for 1999 showed an increase, but then a significant reduction in 2000 and, at least in the Icelandic fishery, again in 2001. There is no obvious trend in Vb, but the Faroese landings seem higher than normal in 2001 (provisional data). Most of the landings from Va and Vb come from longlines, but only partly from aimed fisheries. Norwegian landings are from fisheries primarily targeting ling.

New longline fisheries where tusk is an important target amongst other species appear to develop on the Hatton Bank (VIb and XII) as reported in Working Documents by Hareide *et al.* (2002) and Vinnichenko *et al.* (2002). In recent years, the Spanish (Basque) longliners have also targeted tusk in VI at a higher degree than previously (WD by Lucio *et al.* 2002).

9.2 Stocks

No new information on stock structure was presented. In the 1998 report it was noted that ripening adult tusk and tusk eggs have been found in all parts of the distribution area, but the banks to the west and north of Scotland, around the Faroes and off Iceland, as well as the shelf edge along mid and north Norway seem to be the most important spawning areas (Magnússon *et al.* 1997a). Nothing is known about migrations within the area of distribution. Studies of enzyme and haemoglobin frequencies showed no geographical structure could, hence it was concluded that tusk in all areas, at least of the North-east Atlantic, belong to the same gene pool (Bergstad and Hareide, 1996). Widely separated fishing grounds may support separate management units, i.e., stocks. It is suggested that Iceland (Va) and the Norwegian coast (I and II) have self-contained units, while the separation among possibly several stocks to the north and west of the British Isles remains unclear.

9.3 Catch And Effort Data

Catch per unit of effort data from Norwegian longliners were presented to the Study Group in 1996 (Hareide and Godo, 1996) and were further described in Bergstad and Hareide (1996). This series was not extended beyond 1994. A corresponding time-series extended to 1996 based on official statistics for ling and tusk combined was presented in the 1998 report (ICES C.M. 1998/ACFM:12) but this series has not been extended. Tusk is usually not a target species for the longliners, rather a by-catch in the ling fishery. As suggested in the Chapter 7 on ling, there is little reason to assume that the effort has decreased since 1996.

For the meeting of SGDEEP in 2000, commercial CPUE data for Division Vb were available from Faroese longliners for the period 1986-1999 (ICES CM 2000/ACFM:08, Table 9.2, Fig. 9.1), but this series could not be updated.

A series of effort and CPUE from Icelandic longliners in Division Va is given in Table 9.2, and an index of abundance from the Icelandic groundfish survey from the period 1985-2001 is shown in Figure 9.1.

CPUE of the Basque trawlers and longliners fishing in Sub-areas VI and VII were presented (Figure 9.2). The effort measure is number of trips. Of these series, the one from trawlers may be most reliable.

Data on catch and corresponding effort for the Danish fleet taking tusk in IVa are available for the period 1992-2001 from logbooks, see Table 9.3. It appears that there is a downwards trend for the period. However, since tusk is a by-catch and the catches are small, one should be cautious using these CPUEs alone as indicators for the stock in this area.

Catch and effort data from a Norwegian exploratory longline fishery on the western slope of the Hatton Bank (Vib) in 2001 showed a catch rate of about 160 kg/1000 hooks in the depth zone 500-1000 m (Hareide *et al.* 2002). The effort in the exploratory fishery directed at tusk and blue ling was 154 days and 2541 million hooks.

9.4 Length Distribution, Age Composition, Mean Weight At Age, Maturity

With the exception of updated length composition data from Division Va and from Russian longliners in IIa and b (Figure 9.3), no new data were presented from the most important fisheries and areas.

Data available from earlier years from different Divisions were indicated in Tables 8.3.1–8.3.6 of the 1996 report (ICES C.M. 1996/ Assess:8). An overview of available Norwegian samples were given in Bergstad and Hareide (1996). Very little data were, however, presented since 1997.

Length compositions from Icelandic landings in Va for the period 1995-2001 are shown in Figure 9.4, and length data from the Icelandic groundfish surveys 1985-2001 are shown in Figure 9.5.

Length frequencies from the Irish longline survey in Sub-areas VIb, VII and XII for 2000 are shown in Figures 9.6, 9.7 and 9.8.

9.5 Biological Parameters

No new information on biological parameters was presented. As noted in the 1998 report (ICES C.M. 1998/ACFM:12), considerable information on growth, maturity etc. from many parts of the distribution area were presented in reports from Nordic projects in 1994-1997, i.e., Bergstad and Hareide (1996), Magnússon *et al.* (1997a) and Bergstad *et al.* (1998). The following text table is a compilation of available data, extracted from the report of WGDEEP in 2001 (ICES C.M. 2001/ACFM: 23):

Variable	Value	Source/comment
Longevity (years)	Approx. 20	Bergstad and Hareide 1996, Magnusson <i>et al.</i> 1997
Growth rate, K	No data	Growth curves available in Bergstad and Hareide 1996.
Natural mortality, M	0.1-0.2	Based on review by SGDEEP 2000.
Fecundity (absolute)	millions	No exact data available.
Length at first maturity	40-45 cm	Magnusson <i>et al.</i> 1997
Age at first maturity	8-10 years	Magnusson <i>et al.</i> 1997

Russia reported from an experimental longline fishery in IIa and b in 1999 (Working document by Vinnichenko, 2000), and biological data from previous investigations off Rockall (Working document by Vinnichenko, 2000 referring to article by Zaferman and Shaestopal, 1996). Some new data were also presented in 2002 (WD by Vinnichenko *et al.* 2002).

9.6 Assessment, CPUE Analyses And Mortality Estimates

No new CPUE data were available from the important fishing areas except Va, hence no analyses could be conducted.

The CPUE for the Icelandic longliners in Division Va in 2001 was the lowest on record, and seems to have declined since 1997. The abundance index derived from the groundfish survey in Va has shown an almost uninterrupted declining trend since 1985, and in 2000 and 2001 it was about 35% of the level observed at the beginning of the series. Both CPUE series thus suggest significantly declining abundance. The only indication of a growth in the stock is a somewhat higher abundance of small fish in recent years.

During the 2000 meeting of the SGDEEP, an assessment of tusk was attempted for this Division Vb using a modified DeLury constant recruitment model and a Schaefer surplus production model. There was no insufficient information to carry out similar analysis with data from 2000 and 2001 included.

No new data were provided which could be used to update mortality estimates presented previously.

9.7 Comments On Assessment

It is not possible to make age-based assessments for tusk due to lack of good time series of age-structured data. It is a serious problem that the effort series from the Norwegian longline fishery could not be extended beyond 1996. The Working Group is of the opinion that further improvement in the recording of effort and catch data should be encouraged, since CPUE may be used as an index of abundance and as the basis of production analyses. Such analyses were attempted for Division Vb tusk by SGDEEP in 2000, but could not be conducted in 2002.

9.8 Management Considerations

There was insufficient information to update this evaluation presented by SGDEEP in 2000 (ICES CM 2000/ACFM:23) except for Division Va. In that area there appear to be a decline in the CPUE indices from both surveys and the commercial longliners, and based on the survey data, a rather strong decrease in abundance (to 35% of the level in the mid 1980s) is suggested.

Table 9.1. Tusk (*Brosme brosme*). Working Group estimates of landings (tonnes)**TUSK I**

Year	Norway	Russia	Faroes	Iceland	Total
1996	587				587
1997	665				665
1998	805				805
1999	907				907
2000*	738	43	1	16	798
2001*	595	6		13	614

TUSK IIa

Year	Faroes	France	Germany	Greenland	Norway	E & W	Scotland	Russia	Ireland	Total
1988	115	32	13	-	14,241	2	-			14,403
1989	75	55	10	-	19,206	4	-			19,350
1990	153	63	13	-	18,387	12	+			18,628
1991	38	32	6	-	18,227	3	+			18,306
1992	33	21	2	-	15,908	10	-			15,974
1993	-	23	2	11	17,545	3	+			17,584
1994	281	14	2	-	12,266	3	-			12,566
1995	77	16	3	20	11,271	1				11,388
1996	0	12	5		12,029	1				12,047
1997	1	21	1		8,642	2	+			8,667
1998		9	1		14,463	1	1	-		14,475
1999		7	+		16,213		2	28		16,250
2000*		8	1		13,120	3	2	58		13,192
2001*		15	+		11,200	1	3	66	5 ⁽¹⁾	11,290

⁽¹⁾Includes IIb.**TUSK IIb**

Year	Norway	E & W	Russia	Total
1988		-		0
1989		-		0
1990		-		0
1991		-		0
1992		-		0
1993		1		1
1994		-		0
1995	229	-		229
1996	161			161
1997	92	2		94
1998	73	+	-	73
1999	26		4	26
2000*	15	-	3	18
2001*	141	-	5	146

TUSK IIIa

Year	Denmark	Norway	Sweden	Total
1988	8	51	2	61
1989	18	71	4	93
1990	9	45	6	60
1991	14	43	27	84
1992	24	46	15	85
1993	19	48	12	79
1994	6	33	12	51
1995	4	33	5	42
1996	6	32	6	44
1997	3	25	3	31
1998	2	19		21
1999	4	25		29
2000*	8	23	5	36
2001*	10	41		51

*Preliminary

Table 9.1. continued

TUSK IVa

Year	Denmar	Faroes	France	German	Norway	Sweden ⁽¹⁾	E & W	N.I.	Scotland	Ireland	Total
1988	83	1	201	62	3,998	-	12	-	72		4,429
1989	86	1	148	53	6,050	+	18	+	62		6,418
1990	136	1	144	48	3,838	1	29	-	57		4,254
1991	142	12	212	47	4,008	1	26	-	89		4,537
1992	169	-	119	42	4,435	2	34	-	131		4,932
1993	102	4	82	29	4,768	+	9	-	147		5,141
1994	82	4	86	27	3,001	+	24	-	151		3,375
1995	81	6	68	24	2,988		10		171		3,348
1996	120	8	49	47	2,970		11		164		3,369
1997	189	0	47	19	1,763	+	16		238	-	2,272
1998	114	3	38	12	2,943		11		266	-	3,387
1999	165	7	44	10	1,983		12		213	1	2,435
2000*	208	+	32	10	2,651	2	12		343	1	3,259
2001*	258		26	8	2,443		10		343	1	3,089

⁽¹⁾ Includes IVb 1988-1993

TUSK IVb

Year	Denmark	France	Norway	Germany	E & W	Scotland	Total
1988		n.a.		-	-		
1989		3		-	1		4
1990		5		-	-		5
1991		2		-	-		2
1992	10	1		-	1		12
1993	13	1		-	-		14
1994	4	1		-	2		7
1995	4	-	5	1	3	2	15
1996	134 ⁽¹⁾	-	21	4	3	1	163
1997	6	1	24	2	2	3	38
1998	4	0	55	1	3	3	66
1999	8	-	21	1	1	3	34
2000*	8		106	+	-	2	116
2001*	6		45 ⁽¹⁾	1	1	3	56

⁽¹⁾ Includes IVc

TUSK Va

Year	Faroes	Germany	Iceland	Norway	Scotland	E&W	Total
1988	3,757	-	3,078	20			6,855
1989	3,908	-	3,143	10			7,061
1990	2,475	-	4,816	-			7,291
1991	2,286	-	6,446	-			8,732
1992	1,567	-	6,442	-			8,009
1993	1,329	-	4,746	-			6,075
1994	1,212	-	4,612	-			5,824
1995	979	1	5,245	-			6,225
1996	872	1	5,226	3			6,102
1997	575		4,819				5,394
1998	1,052	1	4,118	0			5,171
1999	1,075	2	5,795	391	1		7,264
2000*	1,302	+	4,714	374	+	1	6,391
2001*	1,049	1	3,407	285	+	1	4,743

*Preliminary

Table 9.1. continued

TUSK Vb1

Year	Denmark	Faroes	France	Germany	Norway	E & W Scotland ⁽¹⁾	Russia	Total
1988	+	2,827	81	8	1,143	-		4,059
1989	-	1,828	64	2	1,828	-		3,722
1990	-	3,065	66	26	2,045	-		5,202
1991	-	3,829	19	1	1,321	-		5,170
1992	-	2,796	11	2	1,590	-		4,399
1993	-	1,647	9	2	1,202	2		2,862
1994	-	2,649	8	1 ⁽²⁾	747	2		3,407
1995		3,059	16	1 ⁽²⁾	270	1		3,347
1996		1,636	8	1	1,083			2,728
1997		1,849	11	+	869		13	2,742
1998		1,272	20	-	753	1	27	2,073
1999		1,956	27	1	1,522		11 ⁽³⁾	3,517
2000*		1,316	13	1	1,191	1	11 ⁽³⁾	2,534
2001*		1,779	13	1	1,572	-	20 ⁽³⁾	3,385

⁽¹⁾Included in Vb₂ until 1996. ⁽²⁾Includes Vb₂. ⁽³⁾Reported as Vb.

TUSK Vb2

Year	Faroe	Norway	E & W Scotland ⁽¹⁾	Total
1988	545	1,061	-	1,606
1989	163	1,237	-	1,400
1990	128	851	-	979
1991	375	721	-	1,096
1992	541	450	-	992
1993	292	285	-	577
1994	445	462	+	909
1995	225	404	⁽²⁾	631
1996	46	536		582
1997	157	420		577
1998	107	530		637
1999	132	315		447
2000*	108	333		441
2001*	150	469		619

⁽¹⁾Includes Vb₁. ⁽²⁾See Vb₁. ⁽³⁾Included in Vb₁.

TUSK VIa

Year	Denmark	Faroes	France ⁽¹⁾	Germany	Ireland	Norway	E & W	N.I.	Scot.	Spain	Total
1988	-	-	766	1	-	1,310	30	-	13		2,120
1989	+	6	694	3	2	1,583	3	-	6		2,297
1990	-	9	723	+	-	1,506	7	+	11		2,256
1991	-	5	514	+	-	998	9	+	17		1,543
1992	-	-	532	+	-	1,124	5	-	21		1,682
1993	-	-	400	4	3	783	2	+	31		1,223
1994	+		345	6	1	865	5	-	40		1,262
1995		0	332	+	33	990	1		79		1,435
1996		0	368	1	5	890	1		126		1,391
1997		0	359	+	3	750	1		137	11	1,261
1998			395	+		715	-		163	8	1,281
1999			193	+	3	113	1		182	47	539
2000*			238	+	20	1,327	8		231	75	1,899
2001*			162	+	31	1,201	8		279	33	1,714

⁽¹⁾ Not allocated by divisions before 1993.

*Preliminary

Table 9.1. continued

TUSK VIb

Year	Faroes	France	Germany	Ireland	Iceland	Norway	E & W	N.I.	Scot.	Russia	Total
1988	217		-	-		601	8	-	34		860
1989	41	1	-	-		1,537	2	-	12		1,593
1990	6	3	-	-		738	2	+	19		768
1991	-	7	+	5		1,068	3	-	25		1,108
1992	63	2	+	5		763	3	1	30		867
1993	12	3	+	32		899	3	+	54		1,003
1994	70	1	+	30		1,673	6	-	66		1,846
1995	79	1	+	33		1,415	1		35		1,564
1996	0	1		30		836	3		69		939
1997	1	1		23		359	2		90		476
1998		1		24	18	630	9		233		915
1999				26	-	591	5		331		953
2000*		2		22		1933	14		372	1	2,344
2001*		1		31		476	10		157	5	680

TUSK VIIa

Year	France	E & W	Scotland	Total
1988	n.a.	-	+	+
1989	2	-	+	2
1990	4	+	+	4
1991	1	-	1	2
1992	1	+	2	3
1993	-	+	+	+
1994	-	-	+	+
1995	-	-	1	1
1996	-	-		
1997	-	-	1	1
1998	-	-	1	1
1999	-	-	+	+
2000*		-	+	+
2001*		-	1	+

TUSK VIIb,c

Year	France	Ireland	Norway	E & W	N.I.	Scotland	Total
1988	n.a.	-	12	5	-	+	17
1989	17	-	91	-	-	-	108
1990	11	3	138	1	-	2	155
1991	11	7	30	2	1	1	52
1992	6	8	167	33	1	3	218
1993	6	15	70	17	+	12	120
1994	5	9	63	9	-	8	94
1995	3	20	18	6		1	48
1996	4	11	38	4		1	58
1997	4	8	61	1		1	75
1998	3		28	-		2	33
1999	-	16	130	-		1	147
2000*	3	58	88	12		3	164
2001*	3	54	177	4		25	263

*Preliminary

Table 9.1. continued

TUSK VIIg-k

Year	France	Germany	Ireland	Norway	E & W	Scotland	Spain	Total
1988	n.a.		-	-	5	-		5
1989	3		-	82	1	-		86
1990	6		-	27	0	+		33
1991	4		-	-	8	2		14
1992	9		-	-	38	-		47
1993	5		17	-	7	3		32
1994	4		12	-	12	3		31
1995	3		8	-	18	8		37
1996	3		20	-	3	3		29
1997	4	4	11	-		+	0	19
1998	2	3	4	-		1	0	10
1999	1	1	-	-		+	6	8
2000*	3		5	-	-	+	3	11
2001*	3		-	9	-	+	2	14

TUSK VIIIa

Year	E & W	France	Total
1988	1	n.a.	1
1989	-	-	-
1990	-	-	-
1991	-	-	-
1992	-	-	-
1993	-	-	-
1994	-	-	-
1995	-	-	-
1996	-	-	-
1997	+	+	+
1998	-	1	1
1999	-	-	0
2000*	-	-	-
2001*	-	-	-

TUSK XII

Year	Faroes	France	Iceland	Norway	Scotland	Total
1988		1				1
1989		1				1
1990		0				0
1991		1				1
1992		1				1
1993		12	+			12
1994		1	+			1
1995	8	-	10			18
1996	7	-	9	142		158
1997	11	-	+	19		30
1998		1		-		1
1999		1		+	1	1
2000*				5	+	5
2001*				51	+	51

*Preliminary

Table 9.1. continued

TUSK XIVa

Year	Germany	Norway	Total
1988	2		2
1989	1		1
1990	2		2
1991	2		2
1992	+		+
1993	+		+
1994	-		+
1995	-		+
1996			+
1997		-	+
1998		-	+
1999		+	+
2000*		-	-
2001*		0	0

TUSK XIVb

Year	Faroes	Iceland	Norway	E & W	Total
1988			-	-	
1989	19	3	-	-	22
1990	13	10	7	-	30
1991	-	64	68	1	133
1992	-	82	120	+	202
1993	-	27	53	+	80
1994	-	9	16	+	25
1995	-	57	30	+	87
1996	-	139	142		281
1997	-	10	108		118
1998	1	-	14		15
1999	-	n.a.	9		9
2000*			11		11
2001*			69		69

*Preliminary

Table 9.1. continued

Tusk, total landings by Sub-areas or Division

Year	I	IIa	IIb	III	IVa	IVb	Va	Vb1	Vb2	VIa	VIb	VIIa	VIIb,c	VIIg-k	VIIIa	XII	XIVa	XIVb	All areas
1988		14,403	0	61	4429	0	6,855	4,059	1,606	2,120	860		17	5	1	1	2	0	34,419
1989		19,350	0	93	6418	4	7,061	3,722	1,400	2,297	1,593	2	108	86		1	1	22	42,158
1990		18,628	0	60	4254	5	7,291	5,202	979	2,256	768	4	155	33		0	2	30	39,667
1991		18,306	0	84	4537	2	8,732	5,170	1,096	1,543	1,108	2	52	14		1	2	133	40,782
1992		15,974	0	85	4932	12	8,009	4,399	992	1,682	867	3	218	47		1		202	37,423
1993		17,584	1	79	5141	14	6,075	2,862	577	1,223	1,003		120	32		12		80	34,803
1994		12,566	0	51	3375	7	5,824	3,407	909	1,262	1,846		94	31		1		25	29,398
1995		11,388	229	42	3348	15	6,225	3,347	631	1,435	1,564	1	48	37		18		87	28,415
1996	587	12,047	161	44	3369	163	6,102	2,728	582	1,391	939		58	29		158		281	28,639
1997	665	8,667	94	31	2272	38	5,394	2,742	577	1,261	476	1	75	19		30		118	22,460
1998	805	14,475	73	21	3387	66	5,171	2,073	637	1,281	915	1	33	10	1	1		15	28,965
1999	907	16,250	26	29	2435	34	7,264	3,517	447	539	953		147	15	0	1		9	32,573
2000*	798	13,192	18	36	3259	116	6,391	2,533	441	1,899	2,344		164	8		5		11	31,215
2001*	614	11,290	146	51	3089	56	4,743	3,385	619	1,714	680	1	263	11		51		69	26,782

*Preliminary

Table 9.2. Effort and CPUE in tusk, as calculated from the Icelandic long-line logbook data.

Effort - No of hooks (*10000)

	Tusk
1994	7020
1995	8487
1996	8228
1997	5377
1998	5411
1999	8969
2000	9992
2001	9431

CPUE (g/hook)

	Tusk
1994	45.7
1995	43.0
1996	52.0
1997	73.2
1998	54.1
1999	59.7
2000	42.1
2001	31.6

Table 9.3. Tusk. Catch per unit effort of Danish trawlers in Sub-areas IVa and IIIa.

DENMARK: logbook recorded catch and effort. Species: **Tusk** Area: **IVA**

Year	Mesh size in Trawl:												All trawls CPUE
	>100 mm			70 - 100 mm			30 - 45 mm			< 25 mm			
	Kg	days	CPUE	Kg	days	CPUE	Kg	days	CPUE	Kg	days	CPUE	
1992	14404	103	139.8	64145	452	141.9	887	20	44.4	39305	334	117.7	130.6
1993	2105	12	175.4	47011	330	142.5	2662	49	54.3	10920	148	73.8	116.3
1994	200	1	200.0	39169	330	118.7	1080	14	77.1	7220	76	95.0	113.2
1995	1490	8	186.3	51129	507	100.8	100	1	100.0	320	8	40.0	101.2
1996	90	2	45.0	106118	1171	90.6	1115	17	65.6	465	6	77.5	90.1
1997	4530	47	96.4	106343	1130	94.1	110	4	27.5	200	3	66.7	93.9
1998	3930	51	77.1	60265	654	92.1	1705	30	56.8	430	10	43.0	89.0
1999	7615	86	88.5	111175	1290	86.2	1135	17	66.8	450	6	75.0	86.0
2000	6385	75	85.1	144620	1453	99.5	680	15	45.3				98.3
2001	28343	224	126.5	163754	1849	88.6	880	24	36.7	600	18	33.3	91.5

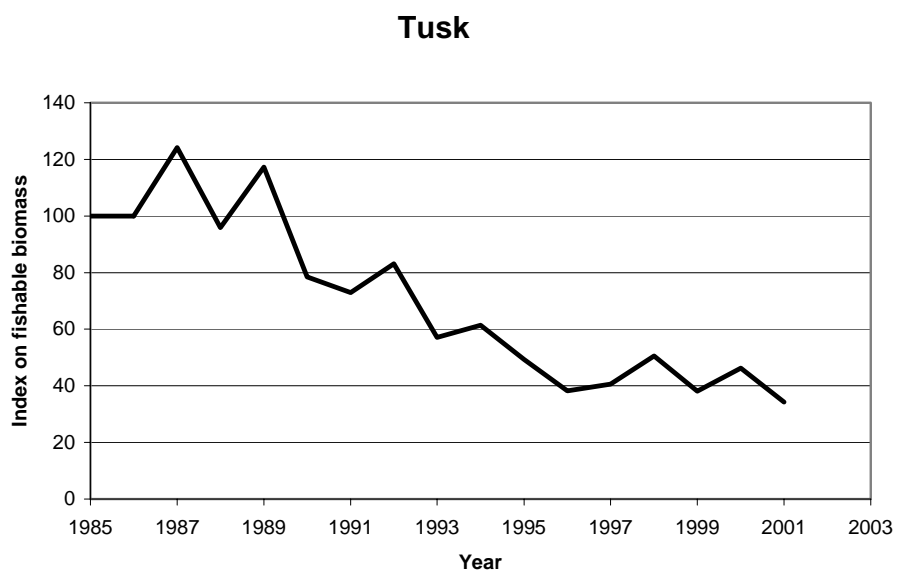
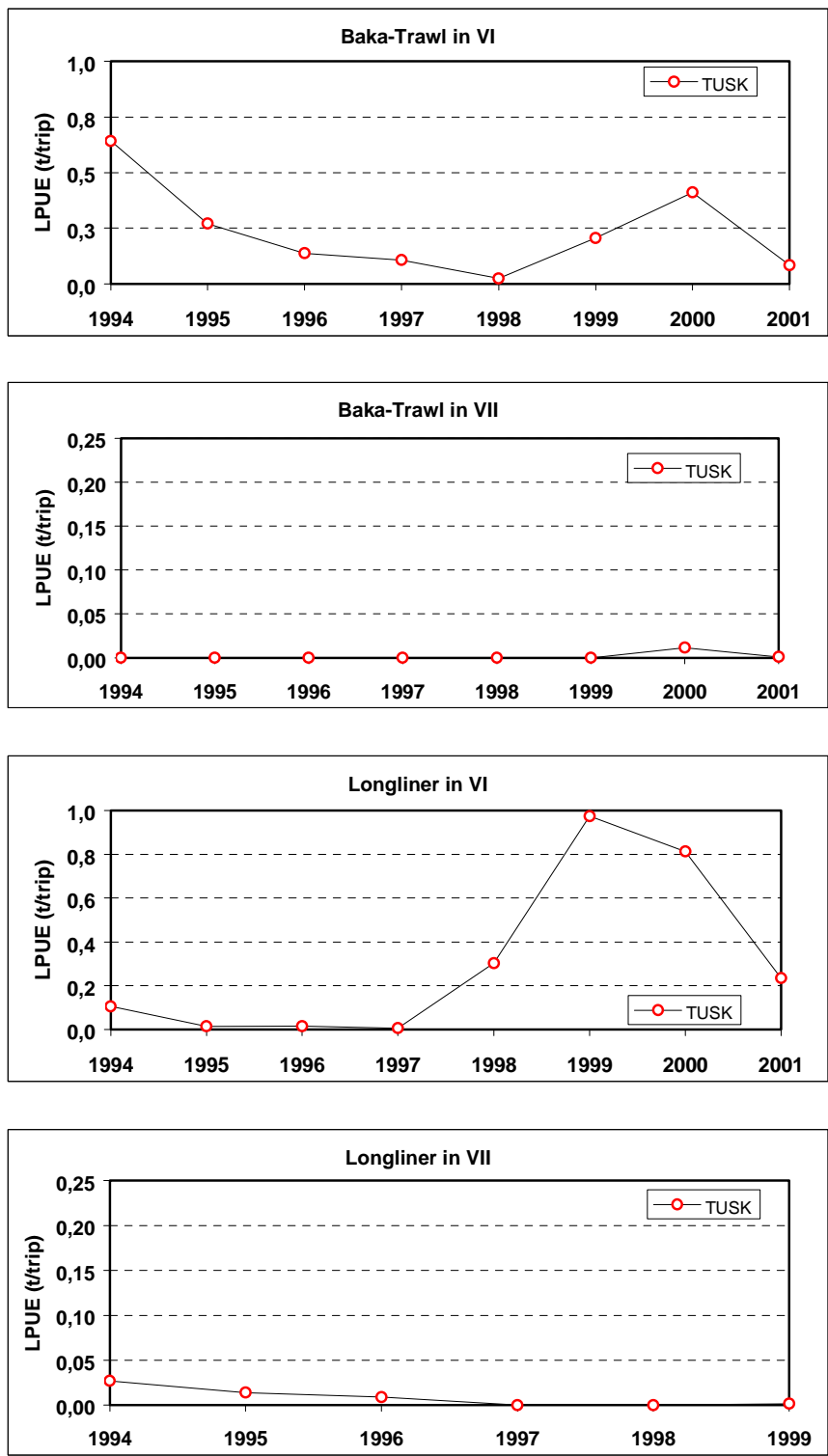

Figure 9.1. Tusk. Index on fishable biomass calculated from the Icelandic groundfish survey at the Icelandic shelf.

Figure 9.2. Landings per fishing effort (LPFE: tones/trip) of Basque “Baka” trawlers and longliners in Sub-area VI and VII (extracted from working document by Lucio *et al.*). (Data on 2001 are preliminary). Data for longliners represent 1-3 vessels only.



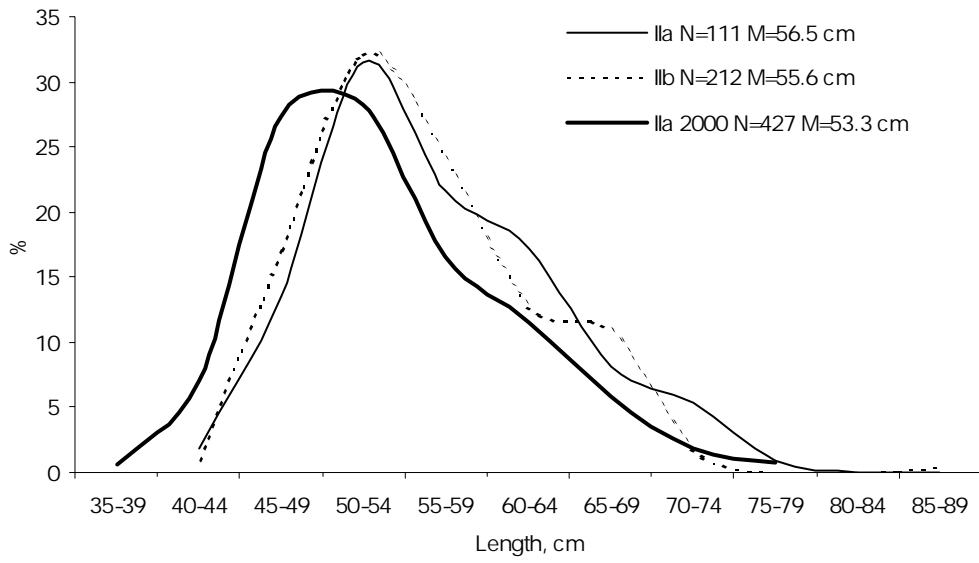

Fig 9.3. Size distribution of tusk in long-line catch in Divs. II a and II b in June 2000 and June 2001.

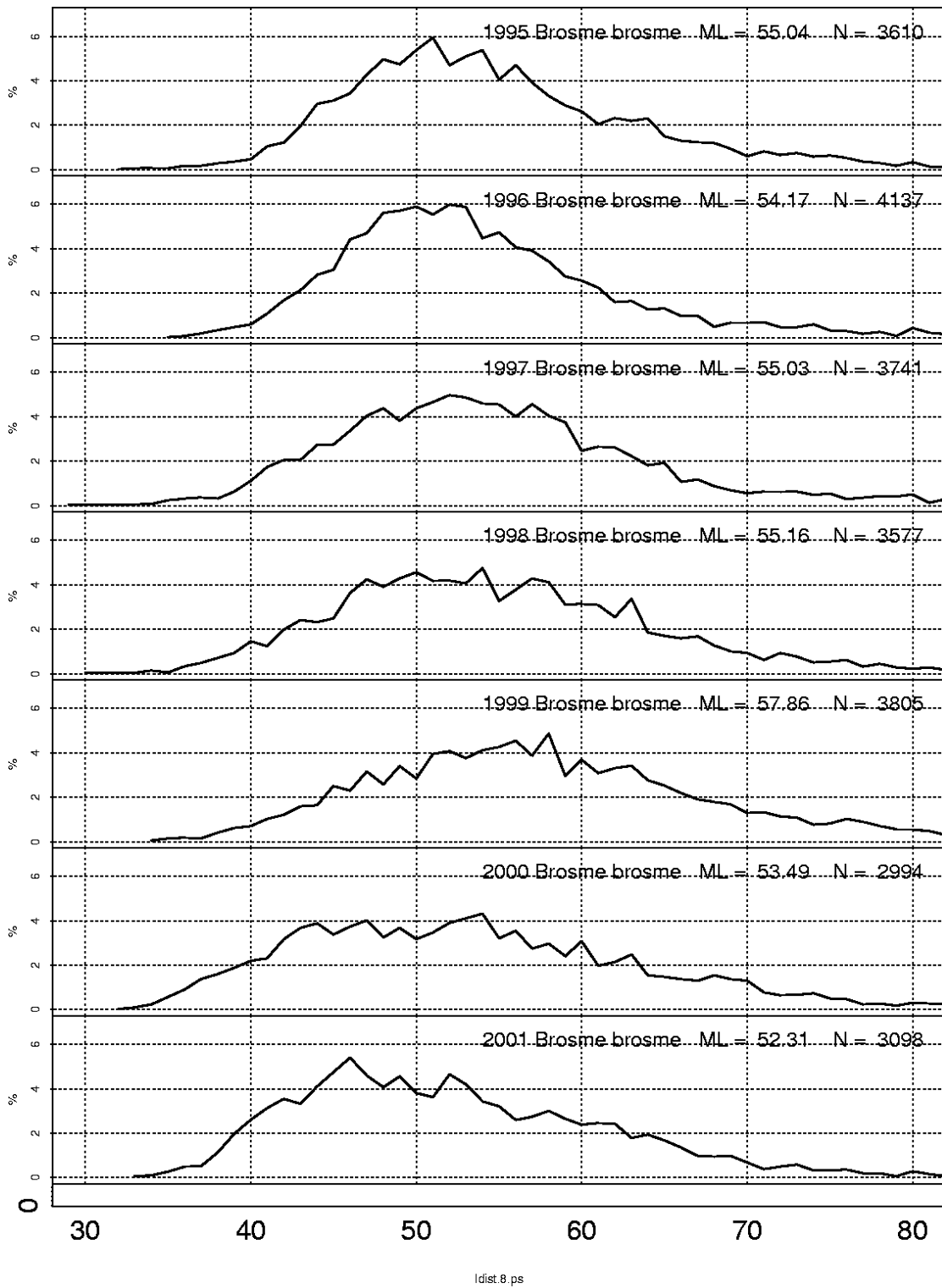

Figure 9.4. Length distribution of tusk in the Icelandic catches since 1995.

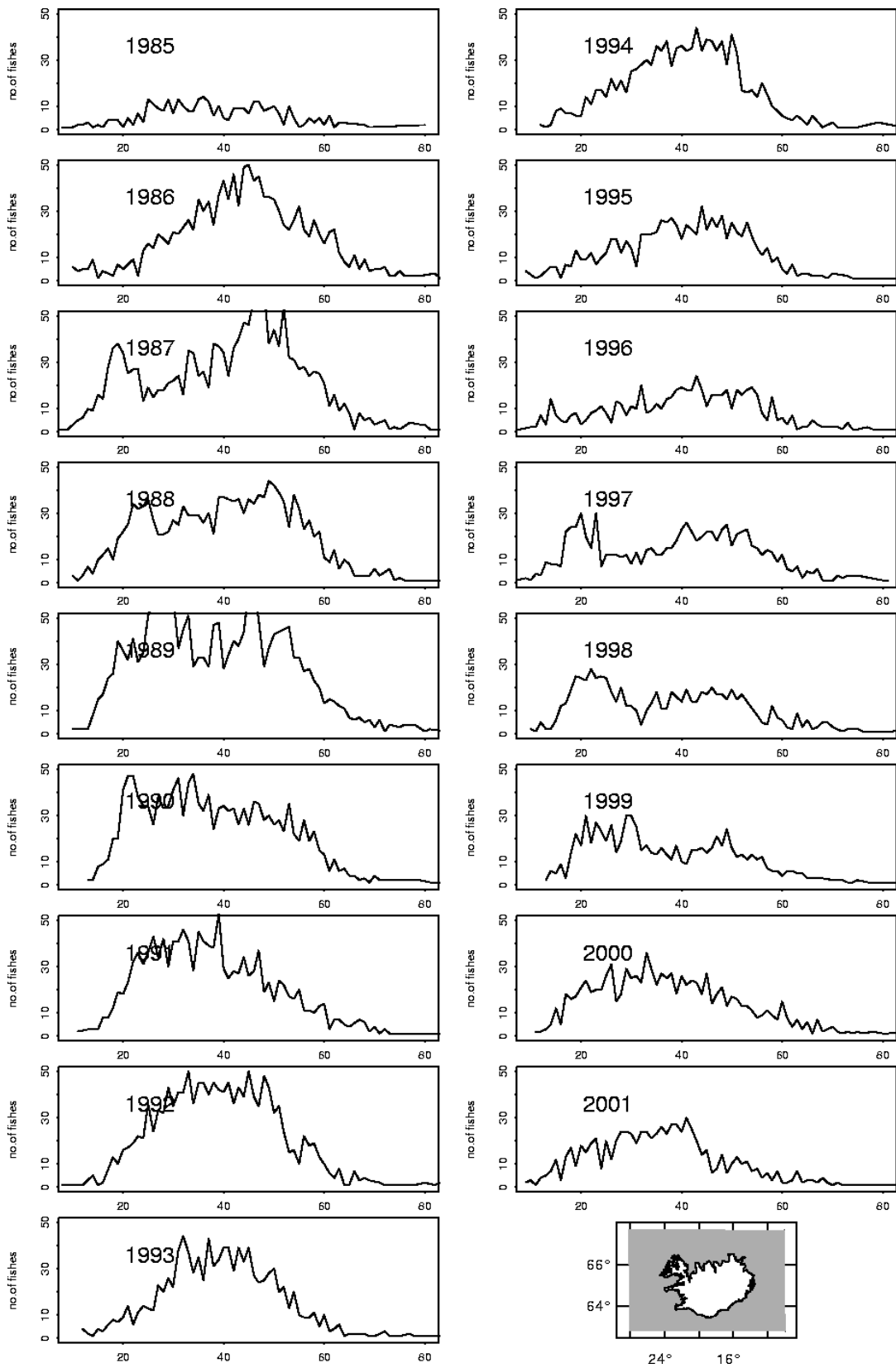

Figure 9.5. Tusk length distributions in the Icelandic groundfish survey in March 1985-2001.

Figure 9.6. Length frequency for *B. brosme* from Irish longline survey of Sub-area VIb in 2000.

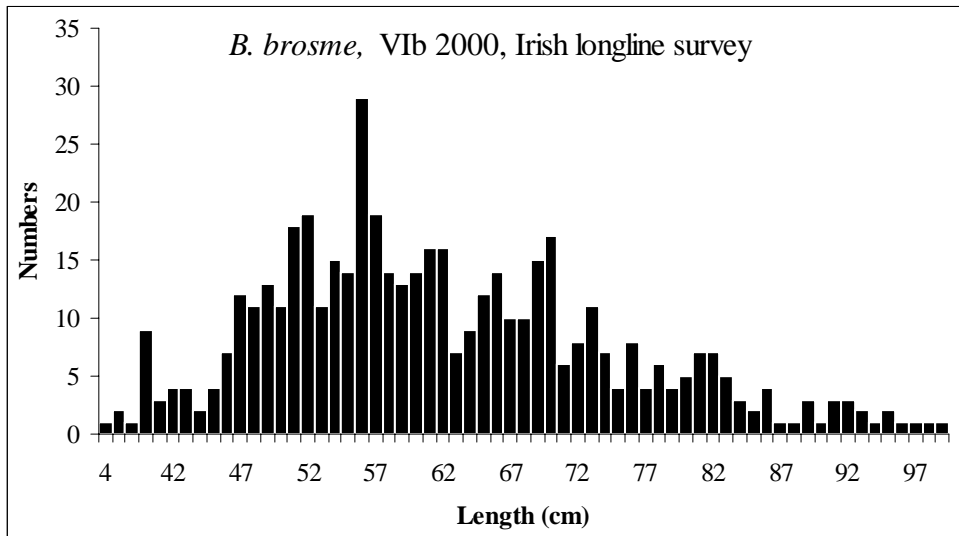

Figure 9.7. Length frequency for *B. brosme* from Irish longline survey of Sub-area VII in 2000.

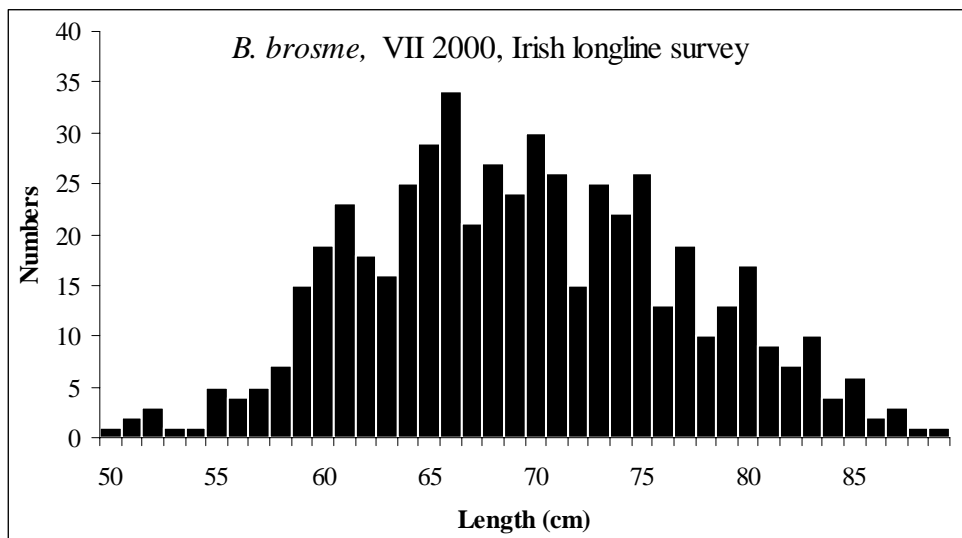
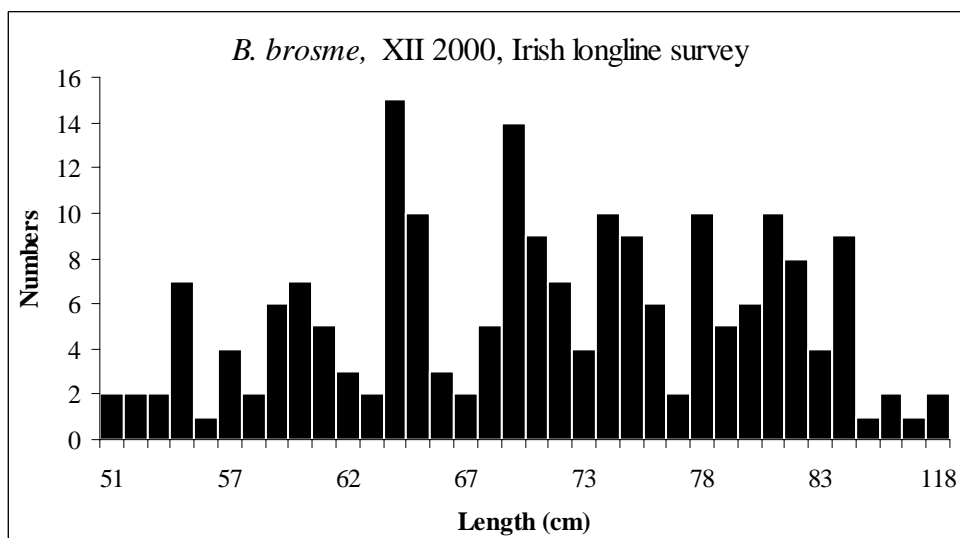

Figure 9.8. Length frequency for *B. brosme* from Irish longline survey of Sub-area XII in 2000.



10 GREATER SILVER SMELT (*ARGENTINA SILUS*)

10.1 Catch trends

Table 10.1 shows the landings data for *Argentina silus* by ICES Sub-areas/Divisions as reported to ICES or as reported to the Working Group.

Landings by Norway from Sub-areas I and II have declined from peak levels of 10 000 to 11 000 t to almost half that level until 2000. This probably represented a change in target species rather than a decline in abundance of *A. silus*. The preliminary landings for 2001 show an increase to over 14,000 t.

Landings in Sub-areas III and IV are mainly by Denmark and Norway. A new description of the Danish fishery is given in Section 6.1.10. The Danish landings from 1992 have been revised and the new data are given in Table 10.1. They have remained around the 1000 t mark except for 1992 and 1999 when they were higher. The Norwegian landings decreased from about 1000 to 2000 t to very low levels in the mid 1990s and have continued to remain at low levels. The estimated Norwegian bycatch in the industrial fishery for Norway pout and blue whiting, based on sampling at fish meal factories, was 333 t in 2000 and 397 t in 2001. There is probably a corresponding or even higher bycatch by the Danish industrial fleet. There is also an unknown bycatch of *A. silus* in the Danish, Norwegian and Swedish fishery for *Pandalus borealis* fishery.

The landings of *A. silus* in Divisions Va and Vb by Iceland and Faroe Islands respectively have increased considerably in recent years.

The previously reported considerable decline in the landings of *A. silus* from Sub-areas VI and VII from a peak in the late 1980s to the mid 1990s has been reversed in recent years and reached an estimated 22273 t were landed in 2001. A new description of the Netherlands fishery is given in Section 6.1.12. Irish landings were very high in the late 1980s when an exploratory fishery was developed by large pelagic trawlers. However by the early 1990s landings had declined to a few hundred tonnes and directed fishing had ceased by 1993. There was some directed fishing for the species in subsequent years. In 2000 and 2001 larger Irish pelagic trawlers began to direct effort at this species on the shelf edge of Sub-area VI a (N). Landings reached over 4500 tonnes in 2000 and an estimated 7500 t in 2001. The landing by Scottish vessels also increased in 2000 and 2001 and between 65 and 75 % of these landings were outside the UK. It is becoming increasingly evident that there are differences in the deep-water fisheries of Sub-areas VI and VII (see blue ling and orange roughy). Table 10.2 gives the separate landings for *A. silus* for sub-areas VI and VII for the years 1999 to 2001.

There were small landings by Iceland from Sub-area XIV

10.2 Stock structure

The limited and hypothetical information on possible stocks was reported in the 1998 Study Group report (CM 1998/ACFM:12) and are summarised in Section 6.3.2.

10.3 Commercial catch-effort and research vessel surveys

Greater Silversmelt.

Data on catch and corresponding effort for the Danish fleets taking Greater Silversmelt in IIIA are available for the period 1992-2001 from the logbooks, see Table 10.3. However, a closer evaluation of the basic logbook data for this species is necessary before accepting these CPUEs as indicators.

Some preliminary logbook catch and corresponding effort for the Danish fleet in Division IIIa are available for the period 1992-2001 but a closer evaluation is necessary before accepting these CPUEs as indicators (see Table 10.5).

A Spanish research bottom trawl survey was carried out in Sub-area VII (Porcupine 0901) in 2001 (See Section 18.1). The distribution of *A. silus* with an indication of biomass is shown in Figure 10.1. This species which has a total mean abundance of 133.24 kg/30 minute haul, is most abundant to the west of the Porcupine bank mainly at depths of more than 400 m.

10.4 Length and Age compositions and mean weights at age

An age-length key for greater argentine sampled from Irish pelagic trawlers targeting the species in Division VIa is presented in Table 10.4. The youngest observed fish were of age 7, whilst the youngest reported by Heessen and Rink (2001) in this area were of age 6.

In the Netherlands fishery in Sub-areas VI and VII a major part of the landings from the Sub-area VI in the first four years of this fishery, consisted of specimens older than 20 years. The maximum age observed was 40 years. Since 1994 the 20+ fish have almost disappeared. Samples from the Sub area VII consisted of younger fish (Heessen and Rink 2001).

Information on the age composition of samples from Norwegian research surveys in Sub-area II in the years 1980 and 1983 has been published (Johannessen and Monstad, 2001).

10.5 Discards

Argentina silus can be a very significant discard of the trawl fisheries of the continental slope of Sub-areas VI and VII. (see Ch 6.4).

Some preliminary French estimates of CPUE for *Argentina silus* by depth of fishing are given in Table 10.5. These are all discarded.

10.6 Biological parameters

Some previously unpublished data on sex distribution by depth, age at maturity, spawning and von Bertalanffy growth parameters from Norwegian research surveys in Sub-area II between 1980 and 1983 have been given by Johannessen and Monstad (2001).

In Sub-areas VI and VII samples were routinely collected for research purposes from selected vessels in the Netherlands commercial fishery. Length and weight at age was slightly greater for females than for males. Fish of the same age are slightly smaller in area south of 56° N. In area north of 56° N, both sexes started to mature at age 3 and at an age of approximately 10 years they were fully mature.

Length weight relationships from the Irish fishery in Sub –area VI a were as follows:

$$\text{Males: } W = - 6.557 L^{3.459}$$

$$\text{Females: } W = - 4.889 L^{3.017}$$

Age estimates obtained for male and female fish and length at age were similar. The females taken by this fishery, which mainly takes place in May, were mostly in a ripe/running state, with small numbers being spent.

In the Spanish survey of 2001 in Sub-area VII (see 18.1) the length distribution (Figure 10.2) reflects the lower abundance of this species in the sector 1, where three modes (16, 22 and 34 cm) are observed, the intermediate one being the most abundant. In the sector 2 the smallest mode is not present. However between the other two (22 and 35 cm) there is a new intermediate mode (26 cm) that is the most abundant in this sector. In the total area plot all four modes are present but the smallest is in low abundance.

The following text table is a compilation of available modified from the report of WGDEEP in 2001 (ICES C.M. 2001/ACFM:23)

Variable	Value	Source/comment
Longevity	~35	Bergstad 1993
Growth rate, K	Male 0.20 Female 0.17	Bergstad 1993 Bergstad 1993
Natural mortality	No data	
Fecundity	6-30 thousand	Wood and Raitt 1968
Length and age at first maturity	Male 36.2 cm, 6-9 y Female 37.2 cm, 6-9 y 3-10 y in VI/VII	Magnusson, 1988, Bergstad 1993 Gordon, 1999 Heessen & Rink 2001

10.7 Assessment

The Norwegian acoustic surveys of the 1980s and early 1990s for Sub-area II were presented in the 1998 report (ICES C.M. 1998/ACFM:12). A report on these surveys was presented at the NAFO deep-sea fisheries symposium (Monstad and Johannessen, 2001).

The Working Group noted the preliminary CPUE series for the Danish fishery in Division IIIa but did not use it for assessment. They were encouraged by this approach and recommended the collection of similar data for other areas.

The 1998 attempt to assess the argentinines in Va was unsuccessful. No new assessments were attempted.

10.8 Management considerations

The WG were concerned about the apparent increase in the directed fishery and increased landings in Sub-area VI. The age range, at least in Sub-area VI, has been truncated in recent years which may suggest high levels of exploitation.

Table 10.1. Argentines. Working Group estimates of landings (tonnes).**ARGENTINES (*Argentina silus*) I and II**

Year	Germany	Netherlands	Norway	Poland	Russia/USSR	Scotland	France	TOTAL
1988			11332	5	14			11351
1989			8367		23			8390
1990		5	9115					9120
1991			7741					7741
1992			8234					8234
1993			7913					7913
1994			6217			590		6807
1995	357		6418					6775
1996			6604					6604
1997			4463					4463
1998	40		8221					8261
1999			7145			18		7163
2000			3 6075		195	18	2	6293
2001*			14357		7	5		14363

ARGENTINES (*Argentina silus*) III and IV

Year	Denmark	Faroes	France	Germany	Netherla	Norway	Scotland	Sweden	Ireland	TOTAL
1988	1062			1		1655				2718
1989	1322				335	2128	1			3786
1990	737			13		1571				2321
1991	1421		1		3	1123	6			2554
1992	4449			1	70	698	101			5319
1993	2347				298	568	56			3269
1994	1480					4	24			1508
1995	1061					1	20			1082
1996	2695	370				213	22			3300
1997	1332			1		704	19	542		2598
1998	2716			128	277	434		427		3982
1999	3772		82		6	5	452		2	4319
2000	1806		270			32	78	273	12	2471
2001*	1653		28			3	227		3	1914

ARGENTINES (*Argentina silus*) Va

Year	Iceland	E & W	TOTAL
1988	206		206
1989	8		8
1990	112		112
1991	247		247
1992	657		657
1993	1255		1255
1994	613		613
1995	492		492
1996	808		808
1997	3367		3367
1998	13387		13387
1999*	5495	23	5518
2000	4593		4593
2001	3046		3046

ARGENTINES (*Argentina silus*) Vb

Year	Faroes	Russia/USSR	UK (Scot)	UK(EW)	Ireland	France	TOTAL
1988	287						287
1989	111	116					227
1990	2885	3					2888
1991	59		1				60
1992	1439	4					1443
1993	1063						1063
1994	960						960
1995	5534	6752					12286
1996	9495		3				9498
1997	8433						8433
1998	17570						17570
1999	8186		15	23		5	8214
2000	7094	1185	247			64	8343
2001	9952	414	94		1		10460

ARGENTINES (*Argentina silus*) VI and VII

Year	Faroese	France	German	Ireland	Netherlands	Norway	E & W	Scotland	N.I.	Russia	Spain	TOTAL
1988				5454		4984						10438
1989	188			6103	3715	12184	198	3171				25559
1990	689		37	585	5871			112				7294
1991			7	453	4723			10	4			5197
1992			1	320	5118			467				5906
1993					1168			409				1577
1994				43	150	4137		1377				5707
1995	1597			357	6	5440		146				7546
1996				1394	295	3953		221				5863
1997				1496	1089	4696		20				7301
1998				463	405	4687						5555
1999			21	24	394	8025		387		5		8856
2000			17	482	4703	3633		4965		29	34	13863
2001			12	189	7494	6882		7620		76		22273

SPA WG data zero in all years 97-2001

ARGENTINES (*Argentina silus*) XII

Year	Faroese	Iceland	TOTAL
1988			
1989			
1990			
1991			
1992			
1993	6		6
1994			
1995			
1996	1		1
1997			
1998			
1999			
2000		2	2
2001			

Table 10.1 continued

ARGENTINES (*Argentina silus*) XIV

Year	Norway	Iceland	TOTAL
1988			
1989			
1990	6		6
1991			
1992			
1993			
1994			
1995			
1996			
1997			
1998			
1999			
2000		217	217
2001	66		66

Argentina silus (all areas)

	I + II	III + IV	Va	Vb	VI + VII	XII	XIV	Total
1988	11351	2718	206	287	10438			25000
1989	8390	3786	8	227	25559			37970
1990	9120	2321	112	2888	7294		6	21741
1991	7741	2554	247	60	5197			15799
1992	8234	5319	657	1443	5906			21559
1993	7913	3269	1255	1063	1577	6		15083
1994	6807	1508	613	960	5707			15595
1995	6775	1082	492	12286	7546			28181
1996	6604	3300	808	9498	5863	1		26074
1997	4463	2598	3367	8433	7301			26162
1998	8261	3982	13387	17570	5555			48755
1999	7163	4319	5518	8214	8856	2		34087
2000	6293	2471	4593	8343	13863		217	36027
2001	14363	1914	3046	10460	15391		66	45174

Table 10.2 Landings of *Argentina silus* by country for ICES Sub-areas VI and VII for 1999 to 2001

Sub-area VI								
	France	Germany	Ireland	Netherlands	Russia	Scotland	Spain	Total
1999	19	24	345	8025	5	387		8805
2000	17	403	4536	3389	29	4965		13339
2001	7	189	5833	6880	76	4838		17823
Sub-area VII								
1999	2		49					51
2000		79	167	244			34	524
2001	5		1661	2		2782		4450

Table 10.3 Danish CPUE for *Argentina silus* in Division IIIa for 1992 to 2001

DENMARK:

logbook recorded catch and effort. Species: **Greater Silversmelt** Area: **IIIa**

Year	Mesh size in Trawl:												All trawls CPUE
	>100 mm			70 - 100 mm			30 - 45 mm			< 25 mm			
	Kg	days	CPUE	Kg	days	CPUE	Kg	days	CPUE	Kg	days	CPUE	
1992				592430	62	9555.3				77601	10	7760.1	9306.0
1993				885880	71	12477.2	720000	36	20000.0	77200	4	19300.0	15162.9
1994				978300	78	12542.3	212000	7	30285.7				14003.5
1995				647140	67	9658.8	423848	98	4325.0	10000	1	10000.0	6512.0
1996				1303420	84	15516.9							15516.9
1997				808360	69	11715.4				136000	4	34000.0	12936.4
1998				703180	56	12556.8							12556.8
1999				885900	65	13629.2	907900	66	13756.1	22000	1	22000.0	13756.1
2000				767300	89	8621.3	169000	9	18777.8	27600	4	6900.0	9450.0
2001				788520	103	7655.5				83000	7	11857.1	7922.9

Table 10.4. Age length key for *Argentina silus* from sampling of Irish pelagic trawlers in Division VIa

Length	7	8	9	10	11	12	13	14	15	16	18	19	20	21	22	23	TOTAL
32	1	1															2
33	2	1					1										4
34	4	2			1												7
35	1	2	1	1		1											6
36		2	5		3	1	1	1									13
37		2	3	1	1	1	1										9
38				3	2		1			1				1			8
39				1	3	3	1	1	1	3							13
40						1			1		1						3
41							1			1	1		1	1	1		6
42					1			1		1	2		2	2			9
43								1			2	1	1			1	6
44									1				1				2
45											1			1			2
46											2			1			3
47											1			1			2
Total	8	10	9	6	11	7	6	4	3	6	10	1	6	6	1	1	95

Table 10.5 Preliminary estimates of catch rates of *A. silus* from French skipper's log books

Depth	Duration (h.)	Kg/h
300	975	73.8
500	5020	12.9
600	13770	32.1
700	20360	19.6
800	28565	19.1

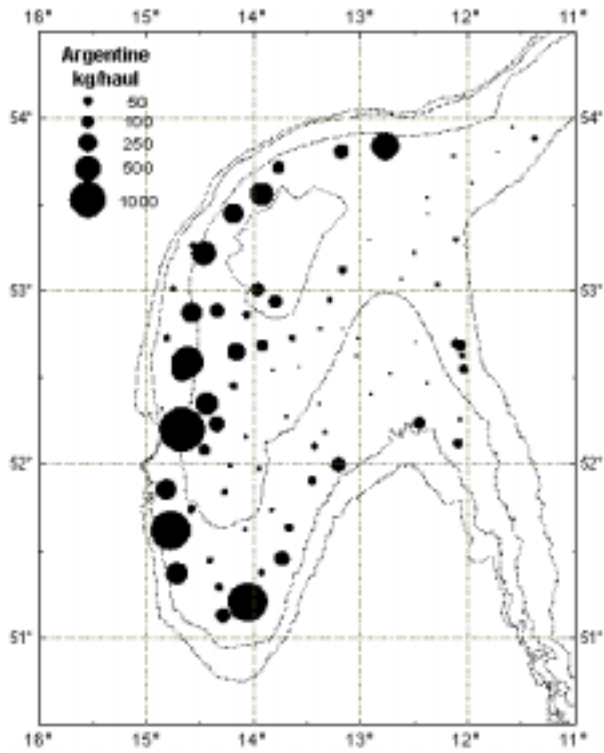

Figure 10. 1 Spanish Bottom Trawl Survey Porcupine 0901: Abundance distribution of *Argentina silus*

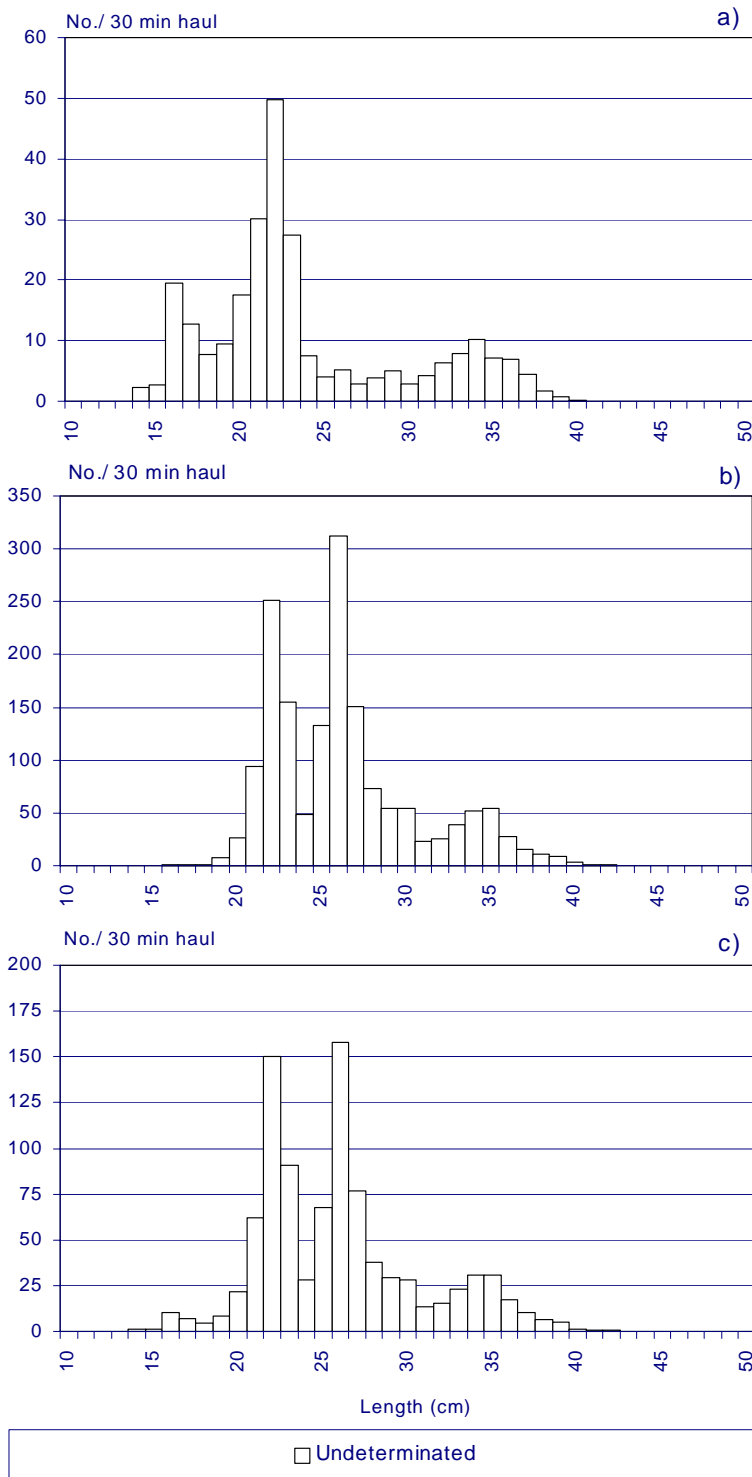

Figure 10.2 Spanish Bottom Trawl Survey Porcupine 0901: Length Distribution (by sector and total) of *Argentina silus*.
a) SE Sector b) NE Sector c) Total area.

11 ORANGE ROUGHY (*HOPLOSTETHUS ATLANTICUS*)

11.1 Catch trends

Table 11.1 shows the landings data of orange roughy by ICES area as reported to the Working Group.

There are currently four fisheries for orange roughy in the North East Atlantic. The main fishery is conducted by French trawlers in ICES sub-areas VI&VII. In 2001, an Irish fishery has rapidly developed in sub-area VII, contributing the bulk of the landings (2400 t). The other fisheries include a Faroese fleet, which mainly operates in sub-areas Vb and international waters (Hatton Bank and mid-Atlantic ridge) and a small Icelandic coastal fleet fishing in sub-area Va. The French fishery in sub-area VI started in 1991 and, after an initial peak of 3500 t, landings declined rapidly to less than 200 t per annum. French landings in sub-area VII peaked in 1992 at around 3100 t and in recent years stabilised at around 1000 t per annum.

11.2 Stocks

The fishing grounds so far discovered in the North Atlantic have been areas where orange roughy aggregate in relatively small units, usually associated with seamounts or other hydrographical or topographical features. It is unknown whether or not these populations represent independent stock units.

11.3 Commercial CPUE and research surveys

French CPUE have been computed for the period 1991-2001 (Table 11.2 and Figure 11.1). As explained in Section 6.1.2, the calculation of the CPUE series had to be altered compared with that used by SGDEEP in 2000 (ICES CM 2000/ACFM:8). A comparison has been made between the CPUE series applied in SGDEEP in 2000 and in WGDEEP 2002, so as to check their consistency over the period 1991-1998. In sub-area VI, the two CPUE trends are not coherent. The WGDEEP 2002 CPUE series has been decreasing exponentially over time, and it has been below 10 kg/h since 1994. By contrast, the SGDEEP 2000 CPUE series increased in the period 1994-1998. The difference between the two time-series is due to a change in the fishing strategy of the French trawlers in the most recent years. The poor state of the orange roughy stock in recent years has incited fishermen fishing in VI to target alternative resources including grenadier, black scabbard and siki. While the effort directed to orange roughy has dropped in recent years, the overall fishing time of the fleet, now directed to the other species, has remained above 5000 hrs per annum. As a result, the SGDEEP 2000 CPUE series, which were based on the directed effort, are higher than the WGDEEP 2002 CPUE series, based on the total fishing time. In sub-area VII, the trends in the two CPUE series are overall consistent. CPUE has decreased over 1991-1995, increased over 1995-1997, and has stabilised since then. The recent CPUE dynamics may simply reflect the discovery and subsequent fishing of previously unexploited aggregations.

An exploratory trawl survey has been conducted in the Azorean Island EEZ (sub-area X) in 2001-2002 (Melo and Menezes, WD 2002). Abundance indices were derived from the catch rates observed during that survey, but there is currently no prospect for resuming this survey in future years.

11.4 Length and age composition

Since SGDEEP 2000, no information has been presented on the length and age composition of orange roughy landings from the waters west of the British Isles. In sub-area X, the length frequency distribution of orange roughy is given in the report of the Azorean survey referred to above. The average length observed was of 49 cm for the females and of 48 cm for the males.

11.5 Biological parameters

A relationship between total individual size (L in cm) and weight (W in g) has been derived from French landings taken off the British Islands:

$$W = 0.022 L^{2.95}$$

The relationship between standard individual size (Ls in cm) and weight (W in g) has also been derived in sub-area X, based on the Azorean exploratory cruise:

$$W = 0.08 Ls^{2.74} \text{ (females)}$$

$$W = 0.10 L^{2.76} \text{ (males)}$$

It is widely recognised that orange roughy has a particularly slow growth. Attempts have been made to estimate its growth parameters, by fitting a Von Bertalanffy curve to age reading information. Parameter k is estimated in the range 0.06-0.07, while L_{∞} is estimated around 60 cm. In the Northeast Atlantic, orange roughy reaches sexual maturity at 34 years, corresponding to an individual length of about 50 cm. The outstanding longevity of orange roughy implies a low natural mortality. M has been estimated using the survival equation:

$$M = \frac{1}{t} \ln \left(\frac{N_0}{N_t} \right)$$

Assuming that 1% of the fish survive up to 125 years, M is around 0.04.

However, it should be stressed that the validation of age-length keys and of subsequently derived biological parameters is still under investigation. Current estimates of the biological parameters of orange roughy off the British Islands are summarised in the text table below:

Variable	Value	Source/comment
Longevity (years)	130	(Allain and Lorange, 2000; Francis and Horn, 1997)
Growth rate, K	0.04-0.05	(Annala and Sullivan, 1996; Tracey and Horn, 1999)
Natural mortality, M	0.04	Annala (1993)
Fecundity (absolute)	28000-385000 ov./ind.	Marine station of Concarneau (France)
Length at first maturity	52 cm	Berrehar, DuBuit and Lorange (unpublished data)
Age at first maturity	?	

11.6 Assessment

Assessment data of this species in the North Atlantic are poor compared with those used for assessing orange roughy stocks in the South West Pacific. It should be noted that the important stocks exploited in the South West Pacific are not assessed by age-structured models, rather by stock reduction models. These assessments mainly rely on survey data such as estimates of the biomass from acoustic and trawling surveys or the two combined. Eggs surveys are also carried out to backcalculate SSB. With the exception of the information derived from the recent exploratory Azorean survey referred to above and scattered research cruises and exploratory fishing activity elsewhere, virtually no relevant survey information is available for North Atlantic stocks.

11.6.1 Sub-area VI

In SGDEEP 2000, a separate assessment was conducted for Sub-area VI. This year, the working group decided not to conduct this assessment. As described in section 11.3, the French fleet used to tune the assessment is now targeting species such as grenadier, black scabbard and squalids, which are located on different fishing grounds than orange roughy. Therefore, the CPUE derived from such a fleet does not reflect appropriately the abundance of orange roughy in that area. This change, and the realization that the stock in Sub-area VI is virtually depleted, made it impossible to conduct an assessment using commercial CPUE series as abundance index.

11.6.2 Sub-area VII

A separate assessment was conducted for Sub-area VII, consistent with the one carried out by SGDEEP in 2000. A range of models, including the modified DeLury constant recruitment model, the Schaefer production model and the stock reduction model, were applied using total international catch data from Sub-area VII for the period 1992-2001, and French CPUE data for otter-trawlers over the same ten-year period.

The DeLury model either gave a poor fit ($R^2 < 0.1$), or did not converge at all, for a range of error models and input ratios of initial stock to virgin biomass.

The fit from the Schaefer model was better for a range of error models, with log transform error giving a marginally better fit ($R^2 = 0.70$). Data explorations have also been made applying the Schaefer model to a range of values of initial stock to virgin biomass (0.7-1.0) and time lags (0-3). For all options, the intrinsic rate of growth (r) was estimated above 1, which is inconsistent with *a priori* knowledge on the longevity of this species. Furthermore, the estimate of total biomass in 2001 (3150 t) was lower than the total international landings recorded during that year (3400 t). The results were, therefore, considered unreliable.

Compared to the Schaefer model, the fit from the stock reduction model provided substantially higher estimates of the biomass at the beginning of 2001 (53000 t). The ratio between current and virgin biomass was 75%. This high value is suspect, and it may barely result from CPUE not being a relevant abundance indicator for species like orange roughy, which are aggregated on local concentrations. A retrospective analysis was also carried out, by comparing these biomass estimates with estimates derived from CPUE series excluding year 2001. The biomass estimates over the period 1989-2000 are reduced by around 30% compared to those derived from the whole CPUE series. They are hence considered sensitive to the introduction of a new year of data. Finally, the current version of the stock reduction model does not provide the statistical diagnostics that would help evaluate the extent to which the model fits the input data. Given these limitations, the Working Group decided not to rely on this assessment for advice purposes.

11.6.3 Other sub-areas

No commercial CPUE were available for the other North-Atlantic sub-areas. An abundance index could be derived from the Azorean exploratory survey, but only for one year. No assessment was conducted in these sub-areas.

11.7 Comments on the assessment

No valid assessment could be conducted this year, for any sub-areas. This observation stresses the limits of the models and of the input CPUE series being applied to assess this species. In particular, neither the assessment models nor the input CPUE series being used, account for the particular spatial dynamics of this locally aggregating species. There is concern that the fleets may exploit local aggregations one after the other. Once an aggregation is fished out, these fleets could explore and harvest other concentrations. In that context, the CPUE of such fleets would not reflect the subsequent depletion of the overall stock. Improving data quality could contribute to address the issue, and this could be done in two ways. Firstly, abundance indices derived from eggs, acoustic and trawling surveys would provide a fishery-independent reflection of stock dynamics. Such surveys hardly exist at the moment. Secondly, commercial CPUE should be made available on a much finer spatial scale, and ideally on a haul-by-haul basis. Such data are currently being collected, but cannot be used yet for confidentiality reasons.

11.8 Management considerations

In sub-area VI, the fishery has almost completely stopped, as a result of stock depletion. The lack of development of this fishery in the most recent years suggests that this stock has not shown any sign of recovery. The remaining catches in the area are likely to prevent any recovery of this stock. The situation in sub-area VII is less clear. Total landings have increased and catch rates have been stable over period 1995-2001, but these features are likely to reflect the sequential discovery and subsequent fishing of previously unexploited aggregations.

Orange roughy are known to grow very old (estimated ages >100 years), and experience in other areas (e.g. South Pacific) has shown that this species is especially vulnerable to exploitation. As a result, newly discovered aggregations are often overexploited before enough information is available to provide timely advice on management. Considering recent observations on the fishery developments (for example in sub-area VII), the exploitation of orange roughy should be strictly limited and the stocks/populations closely monitored. Data obtained should be incorporated into appropriate management measures. These considerations should also apply to areas where there is currently no exploitation on orange roughy.

Table 11.1 Orange roughy. Working Group estimates of landings (tonnes).

ORANGE ROUGHY (*Hoplostethus atlanticus*) Va

Year	Iceland	TOTAL
1988		0
1989		0
1990		0
1991	65	65
1992	382	382
1993	717	717
1994	158	158
1995	64	64
1996	40	40
1997	79	79
1998	28	28
1999	14	14
2000	68	68
2001*	19	19

*Provisional

ORANGE ROUGHY (*Hoplostethus atlanticus*) Vb

Year	Faroes	France	TOTAL
1988		-	0
1989		-	0
1990		22	22
1991		48	48
1992	1	12	13
1993	36	1	37
1994	170	+	170
1995	419	1	420
1996	77	2	79
1997	17	1	18
1998		3	3
1999	4	1	5
2000	155	0	155
2001*	1	4	5

*Provisional

Table 11.1 (continued)

ORANGE ROUGHY (*Hoplostethus atlanticus*) VI

Year	Faroës	France	E & W	Scotland	Ireland	Spain	TOTAL
1988							0
1989		5					5
1990		15					15
1991		3502					3502
1992		1422					1422
1993		429					429
1994		179					179
1995	40	74			2		116
1996	0	116			0		116
1997	29	116	1				146
1998		100				2	102
1999		175			0	1	176
2000		136			2		138
2001*		159		11	110		280

*Provisional

ORANGE ROUGHY (*Hoplostethus atlanticus*) VII

Year	France	Spain	UK (E+W)	Ireland	Scotland	TOTAL
1988						0
1989	3					3
1990	2					2
1991	1406					1406
1992	3101					3101
1993	1668					1668
1994	1722					1722
1995	831					831
1996	879					879
1997	893					893
1998	963	6				969
1999	1157	4				1161
2000	1019		729	1		1749
2001*	1022			2367	22	3411

*Provisional

Table 11.1 (continued)**ORANGE ROUGHY (*Hoplostethus atlanticus*) VIII**

Year	France	Spain VIII+IX	UK (E+W)	TOTAL
1988				0
1989	0			0
1990	0			0
1991	0			0
1992	83			83
1993	68			68
1994	31			31
1995	7			7
1996	22			22
1997	1	22		23
1998	4	10		14
1999	33	6		39
2000	47		5	52
2001*	20			20

*Provisional

ORANGE ROUGHY (*Hoplostethus atlanticus*) IX

Year	Spain	TOTAL
1988		0
1989		0
1990		0
1991		0
1992		0
1993		0
1994		0
1995		0
1996		0
1997	1	1
1998	1	1
1999	1	1
2000	0	0
2001*	0	0

*Provisional

Table 11.1 (continued)

ORANGE ROUGHY (*Hoplostethus atlanticus*) X

Year	Faroes	France	Norway	UK (E+W)	Portugal	TOTAL
1988						0
1989		-				0
1990		-				0
1991		-				0
1992		-				0
1993		-	1			1
1994		-				0
1995		-				0
1996	470	1				471
1997	6	-				6
1998	177	-				177
1999		10				10
2000		3		28	157	188
2001*				28		28

*Provisional

ORANGE ROUGHY (*Hoplostethus atlanticus*) XII

Year	Faroes	France	Iceland	Spain	UK (E+W)	TOTAL
1988						0
1989		0				0
1990		0				0
1991		0				0
1992		8				8
1993	24	8				32
1994	89	4				93
1995	580	96				676
1996	779	36	3			818
1997	802	6				808
1998	570	59				629
1999	345	43		43		431
2000	69	21			2	92
2001*		14			2	16

*Provisional

Table 11.1 (continued)ORANGE ROUGHY (*Hoplostethus atlanticus*), all sea areas

Year	Va	Vb	VI	VII	VIII	X	XII	All areas
1988	0	0	0	0	0	0	0	0
1989	0	0	5	3	0	0	0	8
1990	0	22	15	2	0	0	0	39
1991	65	48	3502	1406	0	0	0	5021
1992	382	13	1422	3101	83	0	8	5009
1993	717	37	429	1668	68	1	32	2952
1994	158	170	179	1722	31	0	93	2353
1995	64	420	116	831	7	0	676	2114
1996	40	79	116	879	22	471	818	2425
1997	79	18	146	893	23	6	808	1973
1998	28	3	102	969	14	177	629	1922
1999	14	5	176	1161	39	10	431	1836
2000	68	155	138	1749	52	188	92	2442
2001*	19	5	280	3411	20	28	16	3779

*Provisional

Table 11.2 Orange roughy in Vb, VI, VII and in combined areas. International landings, French CPUE used by SGDEEP 2000 (WG00), and tuning information (catch, fishing effort and CPUE) used by WGDEEP 2002 (WG02).

ICES sub-area	Year	Total international landings (t)	Data for the reference fleet			
			WG00 cpue (kg/h)	WG02		
				Catch (t)	effort (h)	cpue (kg/h)
Vb	1989	0		0	0	
Vb	1990	22		5	9354	1
Vb	1991	48		36	4320	8
Vb	1992	13	97	4	2321	2
Vb	1993	37	63	1	1137	1
Vb	1994	170		0	1288	0
Vb	1995	420		1	1992	1
Vb	1996	79		2	2053	1
Vb	1997	18		1	3373	0
Vb	1998	3		3	6105	0
Vb	1999	5		1	10119	0
Vb	2000	155		0	7961	0
Vb	2001	5		4	10336	0
VI	1989	5		0	0	
VI	1990	15		3	5521	1
VI	1991	3502	403	1814	8634	210
VI	1992	1422	248	755	8373	90
VI	1993	429	118	242	9088	27
VI	1994	179	87	87	9222	9
VI	1995	116	105	27	10129	3
VI	1996	116	169	39	11244	3
VI	1997	146	175	48	10028	5
VI	1998	102	150	51	9347	5
VI	1999	176		62	6027	10
VI	2000	138		38	9914	4
VI	2001	280		68	5702	12
VII	1989	3				
VII	1990	2		0	21	0
VII	1991	1406	414	1120	3107	360
VII	1992	3101	246	2201	8882	248
VII	1993	1668	151	705	5666	124
VII	1994	1722	159	989	7695	129
VII	1995	831	130	648	6401	101
VII	1996	879	231	663	4042	164
VII	1997	893	400	747	2685	278
VII	1998	969	321	748	3076	243
VII	1999	1161		832	2992	278
VII	2000	1749		503	2615	192
VII	2001	3411		518	2067	251
Combined	1989	8		0	0	
Combined	1990	39		8	14896	1
Combined	1991	4956	408	2970	16061	264
Combined	1992	4536	235	2960	19576	207
Combined	1993	2134	135	948	15891	99
Combined	1994	2071	140	1076	18205	119
Combined	1995	1367	119	676	18522	97
Combined	1996	1074	212	704	17339	155
Combined	1997	1057	347	796	16086	261
Combined	1998	1074	283	802	18528	227
Combined	1999	1342		895	19138	259
Combined	2000	2042		541	20490	179
Combined	2001	3696		590	18105	221

Figure 11.1 Orange roughy in VI, VII and combined areas. CPUE series used in the assessments conducted by SGDEEP in 2000 (WG00) and WGDEEP in 2002 (WG02).

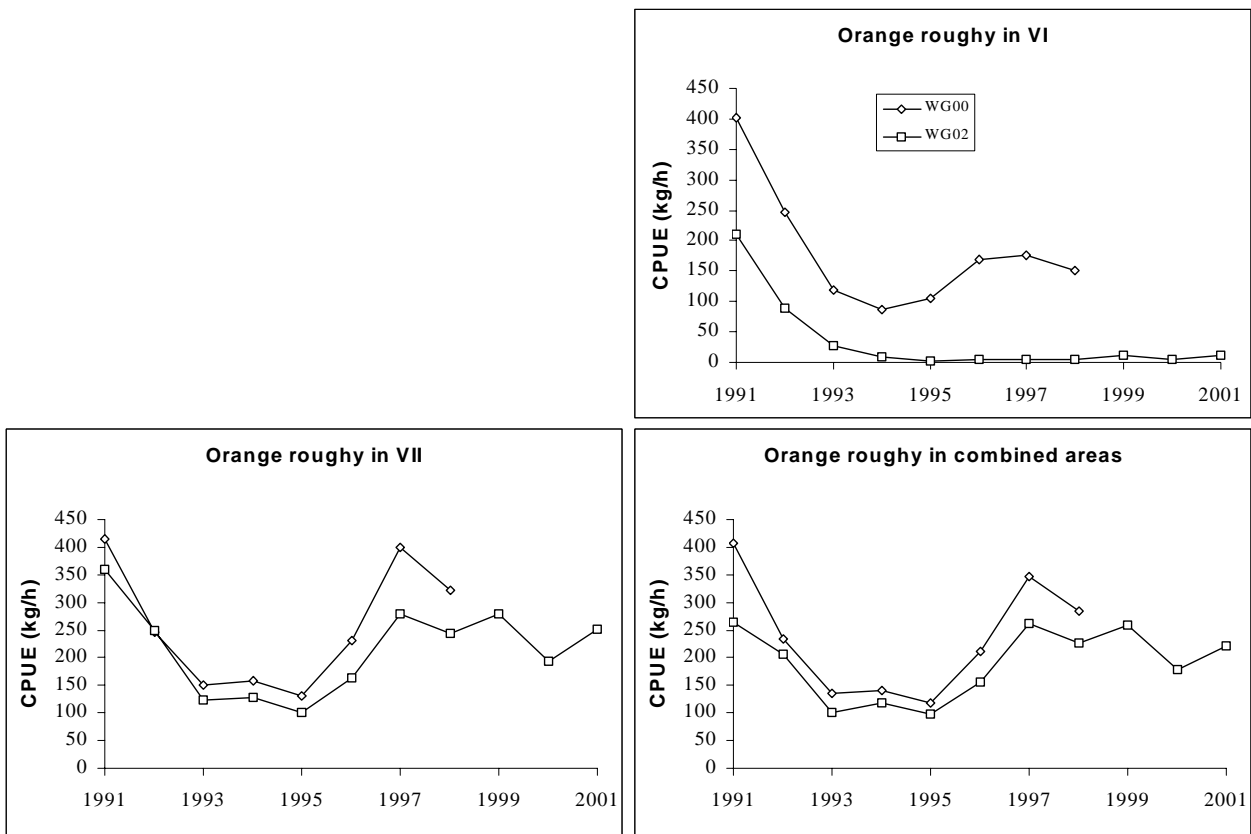

12 ROUNDNOSE GRENADE (CORYPHAENOIDES RUPESTRIS)

12.1 Catch trends

Table 12.1 gives the landings data for *Coryphaenoides rupestris* by ICES sub-areas/Divisions as officially reported to ICES or to the Working Group.

Small catch in Sub-areas I and II are reported. The landings from Sub-area III were revised. The updated landings data suggest that this fishery is highly variable and in some years there is probably no fishery at all. The landings thus vary from 0 to a few thousand tonnes. The highest catches were reported during the last 3 years. As was mentioned in the previous report, roundnose grenadier in sub-area III is also a common by-catch of the shrimp fishery.

Small landings are reported from the northern North Sea (Sub-area IV). In this area the catch decreased from the early 1990s, probably reflecting a change in the fleet's activity in this area.

Icelandic landings in sub-area Va have been increasing in the early 1990s to a peak of about 400 t in 1995, then decreasing to a current level of about 60 t.

The fishery in Division Vb and Sub-areas VI and VII is mainly conducted by French trawlers. In division Vb, the landings from Faroe Islands were important in the early 1990s, but represented less than 10% of the total catch in recent years. In Sub-area VI, the French fishery still contributes more than 50% of the total landings, but landings from Spain and Scotland have increased sharply. In sub-area VII, the French landings peaked at more than 1 900 t in 1993-94, then decreased and remained stable at about 900 t to 1 100 t from 1996 to 2001. Landings from other countries were negligible up to 2001, where more than 400 t were caught by Ireland.

Landings are low in sub-areas VIII, IX and X. In sub-areas XII, a sharp increase has been observed, and from 1997 to 2001 the total landing has varied between 8 500 t and 12 000 t. Spain contributed $\frac{3}{4}$ to these landings. Smaller landings are reported from Russia and Poland and to a lesser extent, France. At least in some years, the reported landing may be well below the actual catch as fleets from countries which do not report catches or landings to ICES are thought to have been fishing in that area.

Small landings (on average 70 t from 1996 to 2001) are reported in sub-area XIV. The German fleet was the most active until 2000, but in 2001 most of the reported landing is Scottish.

12.2 Stock identity

No new data on stock identity of roundnose grenadier was reported. This topic was discussed in 1994 Study Group Report (ICES C.M. 1995/Assess:4) and the general view expressed in 2000 study group report (ICES C.M. 2000/ACFM:8) is summarised below.

Roundnose grenadier in sub-areas II and III may represent separate stock(s) due to physical boundaries to dispersion. For other populations the stock structure remains unclear. On this basis the working group carried out assessment for division Vb and sub-areas VI and VII combined. As in 2000, the sub-area XII was not included because landings in that area include landings from the Mid-Atlantic ridge and the Western part of Hatton Bank. Moreover, catch in Sub-area XII are likely to be significantly under-reported (see above).

12.3 Commercial CPUE

Commercial CPUE were available from the French fleet for ICES Division Vb and Sub-areas VI and VII. The directed CPUE used in the previous assessment was not available to the Working Group (see section 6.1.2). As a consequence, the same reference fleet was used, but a total CPUE was computed (Table 12.2). The comparison of the directed and total CPUE showed that the two series were consistent over the range of years 1991-1998, at least for Sub-area VI were most of the landing are caught and the combination of Vb, VI and VII (Figure 12.1). The series were less consistent at the beginning of the fishery. At that time, a higher proportion of the total effort was directed to other species, probably *Sebastes* in Division Vb and Sub-area VI in 1989-1990 (see also Lorange *et al.*, 2001). Later, the total CPUE from this fleet is very similar to the directed CPUE used in the SGDEEP 2000 report. In fact, the threshold ratio of 10% of roundnose grenadier in the catch in each statistical rectangle visited during a fishing trip was most often reached for this deep-water fleet (Table 12.3). It was thus decided to include the 1999-2001 data in the assessment. Due to the discrepancy between the total and directed CPUE before 1991, however, it was decided not to include the years before 1991.

CPUE of the Spanish fleet working on the Hatton Bank (Sub-area XII and division VIb) was provided for years 2000 and 2001 (Durán Muñoz, WD) and CPUE for 1996-99 is given in Durán Muñoz *et al.* (2001).

Data on catch and corresponding effort for the Danish vessels taking roundnose grenadier in IIIA are available for the period 1992-2001 from the logbooks (Table 12.3). However, a closer evaluation of the basic logbook data for this species is necessary before accepting these CPUEs as indicators.

12.4 Age and length composition

Length compositions from the French catches in Sub-area VI and VII and Division Vb are available from 1990 to 1999 and for 2001 (Table 12.4). Length composition from French trawlers landing in Scotland and sampled by Scotland were available from 1996 to 2000 (Table 12.5). Both indicate a declining trend in the average size observed in the landings, and a reduction of the proportion of larger fishes. Length compositions from the Spanish catch and Sub-area XII and Division VIb were available for years 2000 and 2001 (Table 12.6).

The age interpretation for this species does not create particular concern since readers generally agree on age readings. Moreover, age was validated for juvenile fish (Gordon & Swan, 1996). Some age-length keys from France and Ireland (Rockall Trough area) and Norway (Skagerrak) are available (Bergstad, 1990; Kelly *et al.*, 1997; Lorance *et al.* 2001ab). However no age-based assessment was tried due to lack of time-series of age-disaggregated data.

12.5 Discards

Discards in previous years were estimated in the project EC FAIR CT-95-655 (Gordon, 1999) (see section 2.2 and 6.2). New data were available from the Spanish fleet fishing on the Hatton bank (Division VIb and sub-area XII) provided by the Spanish observer programme established in 1996. On the Hatton bank the Spanish fleet has an average discarding rate in weight of about 10% for the period 1996-2001. Length distributions of the discards of the Spanish fleet were provided in Durán Muñoz (WD) and Durán Muñoz *et al.* (2001). The depth distribution of the fishing activity per year was available for the Spanish fleet only. This figure contrasts with former studies in division Vb and sub-areas VI and VII where the French fishery had a discarding rate of 23% in 1996-97. The reason for this apparent difference is unclear. A starting collaboration between IFREMER and a French fishery organisation (see section 2.3.12) includes discard sampling (Girard, WD). The number of discard samples is currently too low for calculation of a discarding rate of roundnose grenadier.

12.6 Biological data

Age determination was carried out in France for fish collected in 1999 to the west of Scotland during a scientific cruise of R/V Thalassa. The growth parameters from this study were similar to those formerly obtained for the same area. However, due to the lack of larger fish in the sample, estimates of L_{∞} tend to be too high and estimates of K too low in comparison to other studies. These parameters, which are used e.g. in stock reduction models, should hence be treated with caution. This study also suggested that the otolith weight could be an acceptable proxy for age. Testing of this hypothesis is currently on-going. Available data on biological traits of roundnose grenadier are given in the text table below:

Variable	Value	Source/comment
Longevity (years)	60	Bergstad (1990), Kelly et al. (1997), Lorance et al. (2001)
Growth rate, K	0.13 0.11 0.06	Bergstad (1990), Skagerrak Kelly et al. (1997), Rockall Trough Allain & Lorance (2000), Rockall Trough
Natural mortality, M	0.1	Lorance et al. (2001)
Fecundity (absolute)	23 000 (1) 11 000 – 55 000 (2)	Allain (2001), Rockall Trough Kelly et al. (1996)
Pre anal fin length at first maturity (cm)	9 11.5 11	Bergstad (1990), Skagerrak, average of values given for males and females Allain (1999) Durán Muñoz et al. (2001) Hatton Bank. Females
Age at first maturity (years)	9 14	Bergstad (1990), Skagerrak Allain (1999), Rockall Trough

(1) species assessed as a batch spawner, the number of batches per year being unknown

(2) species assessed as a determinated spawner

Length-weight Relationship were compiled for the Hatton Bank (VI + XII) for both sex combined (Durán Muñoz *et al.*, 2001).

No individuals	a	b	R ²	Length range (cm)	Weight range (g)
22642	0.204	2.9636	0.9504	3.5-28	15-3268

12.7 Assessment

A combined assessment of the areas Vb, VI and VII was conducted using total international catch data from 1991 to 1998 and the total CPUE of a French reference fleet (see Section 6.1.2). The change in the CPUE series had a minor impact on the assessment of roundnose grenadier because most of the total fishing effort of this fleet is actually targetting roundnose grenadier.

A Schaefer surplus production model was attempted for the assessment. The time lag was set to 0 meaning that individual growth rather than recruitment provides population growth. Fits were done for a range of ratios of carrying capacity to initial biomass from 0.7 to 1. Consistent with view held by SGDEEP 2000, it was assumed that this resource was initially only slightly depleted. As the starting year in the assessment is now 1991, ratios in the range of 80-85 % were believed to be the most likely. However, all the fits were highly sensitive to input parameters, R² coefficients were low and estimates of carrying capacity and current population values were considered not reliable.

12.8 Comment on assessment

The result of the assessment was considered unreliable as the model simulated a capacity of the stock to produce biomass at a rate which is not consistent with the knowledge of the life history of the species (longevity and individual growth rate).

12.9 Management considerations

The observed increasing CPUE over recent years is not believed to reflect an increase of the stock size. It is much more likely to reflect a change in the fishing strategy, in the geographical distribution of effort or in the fish accessibility.

Then, the long term decreasing trend in CPUE is expected to resume in the next years. Although no assessment could be carried out, trends in the size composition of the landings towards smaller fish (Tables 12.4 and 12.5) suggest that the stock is severely impacted by the fishery and current level of catches are likely to be unsustainable. In most areas, roundnose grenadier is the target species of a mixed trawl fishery.

Table 12.1 Roundnose grenadier (*Coryphaenoides rupestris*). Study Group estimates of landings (tonnes). Data from 2000 and 2001 are preliminary.

ROUNDNOSE GRENADIER (*Coryphaenoides rupestris*) I and II

Year	Faroe	Denmark	France	GFR/Germany	Norway	Russia/USSR	GDR	UK(E+W)	UK(Scot)	TOTAL
1988										
1989			1		2		16	3		22
1990			32		2		12	3		49
1991			41		3	28				72
1992		1	22		0	29				52
1993			13		0	2				15
1994			3		12					15
1995			7							7
1996			2							2
1997	1		5		100					106
1998			0		87		13			100
1999*			0		44		2			46
2000			0						0	0
2001*			0					2	0	2

ROUNDNOSE GRENADIER (*Coryphaenoides rupestris*) III

Year	Denmark	Norway	Sweden	TOTAL
1988	612		5	617
1989	884		1	885
1990	785	280	2	1067
1991	1214	304	10	1528
1992	1362	211	755	2328
1993	1103	55		1158
1994	517		42	559
1995	0		1	1
1996	2213			2213
1997	0	124	42	166
1998	1490	329		1819
1999*	3113	13		3126
2000	2400	4		2404
2001*	3067	35		3102

ROUNDNOSE GRENADIER (*Coryphaenoides rupestris*) IV

Year	France	Germany	Norway	Scotland	Denmark	TOTAL
1988			1			1
1989	167		1		2	170
1990	370		2			372
1991	521		4			525
1992	421			4	1	426
1993	279		4		0	283
1994	185		2		25	212
1995	68		1		15	84
1996	59				5	71
1997	1			10	0	11
1998	35		0		0	35
1999*	56		5		0	61
2000	2				0	2
2001*	2				17	19

Table 12.1 continued

ROUNDNOSE GRENADIER (*Coryphaenoides rupestris*) Va

Year	Faroes	Iceland***	Germany	UK(E+W)	TOTAL
1988		2			2
1989	2	2			4
1990		7			7
1991		48			48
1992		210			210
1993		276			276
1994		210			210
1995	0	398			398
1996	1	139			140
1997	0	198			198
1998		120	0		120
1999*		129	0		129
2000		67			67
2001*		57		0	57

*** includes other grenadiers from 1988 to 1996

ROUNDNOSE GRENADIER (*Coryphaenoides rupestris*) Vb

Year	Faroes	France	Norway	Germany	Russia/USSR	UK	TOTAL
1988				1			1
1989	20	181		5	52		258
1990	75	1470		4			1549
1991	22	2281	7	1			2311
1992	551	3259	1	6			3817
1993	339	1328		14			1681
1994	286	381		1			668
1995	405	818					1223
1996	93	983		2			1078
1997	53	1059					1112
1998	50	1617					1667
1999*	104	1861	2	0		29	1996
2000	44	1699		1	1	43	1788
2001*		1719					1719

ROUNDNOSE GRENADIER (*Coryphaenoides rupestris*) VI

Year	Faroes	France	Germany	Ireland	Norway	Spain	E & W	UK	Russia	TOTAL
1988	27		4				1			32
1989	2	2211	3					2		2218
1990	29	5484	2							5515
1991		7297	7							7304
1992	99	6422	142		5		2	112		6782
1993	263	7940	1					1		8205
1994		5898	15	14				11		5938
1995	0	6329	2	59				82		6472
1996	0	5888						156		6044
1997	15	5795		4	-			218		6032
1998	13	5170			21	3				5207
1999		5637	3	1	-	1				5642
2000		7423		41	1	1002	1	433		8901
2001*		5587	6	31	32	2166	21	955	3	8801

Table 12.1 continued**ROUNDNOSE GRENADIER (*Coryphaenoides rupestris*)**

Year	France	Ireland	Spain	TOTAL
1988				0
1989	222			222
1990	215			215
1991	489			489
1992	1556			1556
1993	1916			1916
1994	1922			1922
1995	1295			1295
1996	1051			1051
1997	1033		5	1038
1998	1146		11	1157
1999	892		4	896
2000	889		0	889
2001*	914	416	0	1330

ROUNDNOSE GRENADIER (*Coryphaenoides rupestris*) VIII and IX

Year	France	Spain	TOTAL
1988			0
1989	0		0
1990	5		5
1991	1		1
1992	12		12
1993	18		18
1994	5		5
1995	0		0
1996	1		1
1997	0	0	0
1998	1	19	20
1999	9	7	16
2000	4	5	9
2001*	7	3	10

ROUNDNOSE GRENADIER (*Coryphaenoides rupestris*)**X**

Year	Faroes	France	UK	TOTAL
1988				
1989				0
1990				0
1991				0
1992				0
1993				0
1994				0
1995	0			0
1996	3			3
1997	1			1
1998	1			1
1999	3	3		6
2000	0	0	74	74
2001*	0			0

Table 12.1 continued

ROUNDNOSE GRENADE (Coryphaenoides rupestris) XII

Year	Faroes**	France	Germany	Iceland	Ireland	Latvia	Russia/USSR	Poland	Spain
1988							10600		
1989		0					9500		
1990		0					2800		
1991		14				4296	3200		
1992		13				1684	300		
1993		26	39			2176	500		
1994	457	20	9			675			
1995	359	285							
1996	136	179		77			200		1136
1997	138	111					700	5867	1800
1998	19	116					800	6769	4262
1999		287				(1)	576	546	8251
2000		391					2325		5791
2001*		156			3		1714		7670

(1) provisional, indication of important catches from Latvia in 1999, without official report

* includes some from VIb in 1995

ROUNDNOSE GRENADE (Coryphaenoides rupestris) XII (continued)

Year	UK(E+W)	Germany	UK (Scotl.)	Norway	TOTAL
1988					10600
1989					9500
1990					2800
1991					7510
1992					1997
1993					2741
1994					1161
1995					644
1996					1728
1997					8676
1998					11978
1999					9660
2000		9	6		8522
2001*			7	1	9551

ROUNDNOSE GRENADE (Coryphaenoides rupestris) XIV

Year	Faroes	Germany	Greenland	Iceland****	Norway	E & W	Scotland	Russia	TOTAL
1988		45		7					52
1989	3	42							45
1990		45		1			1		47
1991		23		4			2		29
1992		19		1	4	6		1	31
1993		4		18	4				26
1994		10		5					15
1995	0	13		14					27
1996	0	6		19					25
1997	6	34		12		7			59
1998	1	116		3		6			126
1999		105		0		19			124
2000		41				5			46
2001*		11				7	2	72	92

ROUNDNOSE GRENADIER (<i>Coryphaenoides rupestris</i>) all sea areas												
Year	I+II	III	IV	Va	Vb	VI	VII	VII+IX	X	XII	XIV	Total
1988		617	1	2	1	32	0	0		10600	52	11 305
1989	22	885	170	4	258	2218	222	0	0	9500	45	13 324
1990	49	1067	372	7	1549	5515	215	5	0	2800	47	11 626
1991	72	1528	525	48	2311	7304	489	1	0	7510	29	19 817
1992	52	2328	426	210	3817	6782	1556	12	0	1997	31	17 211
1993	15	1158	283	276	1681	8205	1916	18	0	2741	26	16 319
1994	15	559	212	210	668	5938	1922	5	0	1161	15	10 705
1995	7	1	84	398	1223	6472	1295	0	0	644	27	10 151
1996	2	2213	71	140	1078	6044	1051	1	3	1728	25	12 356
1997	106	166	11	198	1112	6032	1038	0	1	8676	59	17 399
1998	100	1819	35	120	1667	5207	1157	20	1	11978	126	22 230
1999	46	3126	61	129	1996	5642	896	16	6	9660	124	21 702
2000	0	2404	2	67	1787	8901	889	9	74	8522	46	22 701
2001*	2	3102	19	57	1719	8801	1330	10	0	9551	92	24 683

*Provisional

Table 12.2 Roundnose grenadier. CPUE data used for assessment: total catch, total effort and CPUE or the reference fleet, Total international catch and SG2000 directed CPUE.

ICES sub-area	Year	Total international catch (t)	Data for the reference fleet			
			WG01 CPUE (kg/h)	WG02		
				Catch (t)	effort (h)	CPUE (kg/h)
V	1989	258	171	159	7216	22
V	1990	1549	301	1047	9354	112
V	1991	2311	430	1162	4320	269
V	1992	3817	332	670	2321	289
V	1993	1681	320	329	1137	289
V	1994	668	241	206	1288	160
V	1995	1223	286	462	1992	232
V	1996	1078	234	479	2053	233
V	1997	1112	202	508	3373	151
V	1998	1667	151	804	6105	132
V	1999	1996		1794	10119	178
V	2000	1743		1668	7961	210
V	2001	1719		1640	10336	159
VI	1989	2218	311	197	5702	35
VI	1990	5515	541	2169	5521	393
VI	1991	7304	400	3060	8634	354
VI	1992	6782	217	1438	8373	172
VI	1993	8205	239	1802	9088	198
VI	1994	5938	205	1376	9222	149
VI	1995	6472	217	1838	10129	181
VI	1996	6044	156	1581	11244	141
VI	1997	6032	168	1460	10028	146
VI	1998	5207	101	804	9347	86
VI	1999	5644		478	6027	83
VI	2000	8901		2099	9914	218
VI	2001	8803		1091	5702	198
VII	1989	222	0	0	35	0
VII	1990	215	0	0	21	0
VII	1991	489	91	254	3107	82
VII	1992	1556	134	1053	8882	119
VII	1993	1916	195	992	5666	175
VII	1994	1922	161	1005	7695	131
VII	1995	1295	159	889	6401	139
VII	1996	1051	143	564	4042	140
VII	1997	1038	151	366	2685	136
VII	1998	1157	124	314	3076	102
VII	1999	896		250	2992	92
VII	2000	901		178	2615	74
VII	2001	1330		137	2067	73
Combined	1989	2698	212	356	12953	29
Combined	1990	7279	365	3216	14896	301
Combined	1991	10104	312	4476	16061	317
Combined	1992	12155	201	3161	19576	179
Combined	1993	11802	239	3123	15891	201
Combined	1994	8528	202	2587	18205	143
Combined	1995	8990	211	3189	18522	177
Combined	1996	8173	162	2624	17339	157
Combined	1997	8182	166	2334	16086	145
Combined	1998	8031	113	1922	18528	108
Combined	1999	8536		2582	19138	152
Combined	2000	11545		4030	20490	208
Combined	2001	11852		2928	18105	170

Table 12.3. Reference fleet: ratio of effort directed to roundnose grenadier to total from 1989 to 1998 (range of years where the directed effort is known).

Year	Vb	VI	VII	Combined
1989	0.07	0.09	0.00	0.07
1990	0.33	0.64	0.00	0.33
1991	0.66	0.74	0.61	0.66
1992	0.81	0.70	0.80	0.81
1993	0.87	0.74	0.90	0.87
1994	0.64	0.66	0.78	0.64
1995	0.73	0.79	0.82	0.73
1996	0.83	0.85	0.93	0.83
1997	0.73	0.81	0.84	0.73
1998	0.81	0.76	0.72	0.81

Table 12.4 Logbook recorded catch and effort from Danish trawlers in division IIIa.

DENMARK:

logbook recorded catch and effort. Species: **Roundnose Genadier** Area: **IIIa**

Year	Mesh size in Trawl:												All trawls CPUE
	>100 mm			70 - 100 mm			30 - 45 mm			< 25 mm			
	Kg	days	CPUE	Kg	days	CPUE	Kg	days	CPUE	Kg	days	CPUE	
1992				668290	68	9827.8	56000	36	1555.6	92500	11	8409.1	7102.5
1993	515	2	257.5	567215	71	7988.9	419800	45	9328.9	65000	4	16250.0	8627.3
1994				1467785	95	15450.4	121500	46	2641.3				11271.5
1995				1105522	66	16750.3	974250	172	5664.2				8738.5
1996				1016505	79	12867.2	62100	34	1826.5				9545.2
1997				1321280	82	16113.2				35000	3	11666.7	15956.2
1998				3893000	132	29492.4	5000	5	1000.0	100000	3	33333.3	28557.1
1999				1586175	82	19343.6	450	5	90.0				18237.1
2000				1305955	98	13326.1	330000	11	30000.0	160000	6	26666.7	15617.0
2001				1922900	130	14791.5				112500	9	12500.0	14643.2

Table 12.4 Roundnose grenadier, percent length composition (pre-anal fin length) per year of the French landings landed in France.

Pre-anal Length cm	1990	1991	1992	1993	1994	1995	1996	1997	1998	1999	2001
10											
11						0.20					
12						1.82	0.27	0.20		0.12	
13				0.34	0.63	5.85	0.77	1.21	0.55	1.82	0.64
14		0.50		1.58	3.87	8.31	3.98	6.06	2.86	8.37	6.52
15	0.47	0.53	0.93	8.61	5.41	14.64	9.00	14.14	9.86	17.23	18.76
16	1.07	2.56	3.47	9.55	12.77	15.32	15.70	11.92	15.76	23.67	20.19
17	5.16	7.39	9.73	16.17	17.65	13.86	15.17	15.96	16.22	21.36	14.15
18	9.89	10.67	15.51	18.18	16.02	14.95	16.23	15.15	16.04	15.17	14.15
19	12.28	14.11	14.56	15.76	14.11	10.25	14.19	9.70	15.12	6.80	9.38
20	15.08	16.19	18.57	14.08	13.36	7.92	10.84	10.71	10.78	3.40	7.31
21	19.05	17.70	11.76	8.37	10.07	5.03	7.97	7.27	6.73	1.09	4.29
22	14.69	14.29	10.99	4.47	3.72	1.25	2.89	5.05	4.24	0.73	3.34
23	12.95	9.50	8.43	2.06	1.37	0.40	1.33	1.62	1.38	0.12	0.48
24	5.77	5.26	4.10	0.54	0.68	0.20	1.11	0.61	0.46	0.12	0.64
25	3.07	0.91	1.20	0.15	0.17		0.56	0.40			0.16
26	0.29	0.39	0.58	0.15							
27	0.24		0.16		0.17						
28											
29											
30											

Table 12.5 Roundnose grenadier, percent length composition (pre-anal fin length) per year of French catches landed in Scotland.

Pre-anal fin length	1996	1997	1998	1999	2000
10	0	0	0	0	0
11	0.09	0.13	0.14	0.04	0.05
12	0.24	0.52	0.37	0.93	0.56
13	1.56	3.36	2.26	3.49	4.07
14	6.66	10	8.04	9.6	11.68
15	14.31	15.06	13.96	15.23	15.23
16	18.24	18.89	18.77	19.51	14.05
17	18.85	17.79	19.41	17.7	13.48
18	15.48	13.92	14.66	13.76	14.63
19	11.66	10.21	10.54	10.55	11.94
20	7.57	5.66	7.12	5.31	7.38
21	4.31	2.81	3.47	2.45	4.31
22	0.83	1.02	0.92	0.85	1.79
23	0.2	0.51	0.28	0.27	0.8
24	0	0.08	0.05	0.14	0
25	0	0.04	0	0.16	0
26	0	0	0	0	0

Table 12.6 Roundnose grenadier, percent length composition (pre-anal fin length) per year of Spanish catches, sampled on board before sorting out of retained landings and discards in division VIb and sub-area XII.

	VIb(2000)	VIb(2001)	XII(2000)	XII(2001)
4			0.00	0.00
5	0.03	0.03	0.07	0.07
6	0.17	0.97	0.23	0.59
7	0.53	1.93	0.72	1.24
8	0.91	1.73	1.47	1.63
9	1.79	3.41	2.65	2.40
10	3.72	5.39	4.84	5.91
11	7.82	6.40	7.90	7.14
12	12.87	9.10	10.25	10.80
13	17.26	11.85	12.55	13.81
14	19.34	16.09	14.97	13.76
15	13.79	13.59	13.92	14.53
16	10.34	10.29	10.82	9.80
17	5.84	8.32	8.01	7.01
18	3.27	4.14	5.07	4.46
19	1.17	2.47	2.73	2.74
20	0.53	1.84	1.68	1.71
21	0.39	1.08	1.15	0.88
22	0.15	1.02	0.52	0.75
23	0.08	0.31	0.22	0.30
24		0.04	0.12	0.22
25			0.08	0.21
26			0.01	0.03
27			0.01	
Catch (tonnes)	1109	2374	6211	8226
Number fish measured	1170	3939	17947	10043

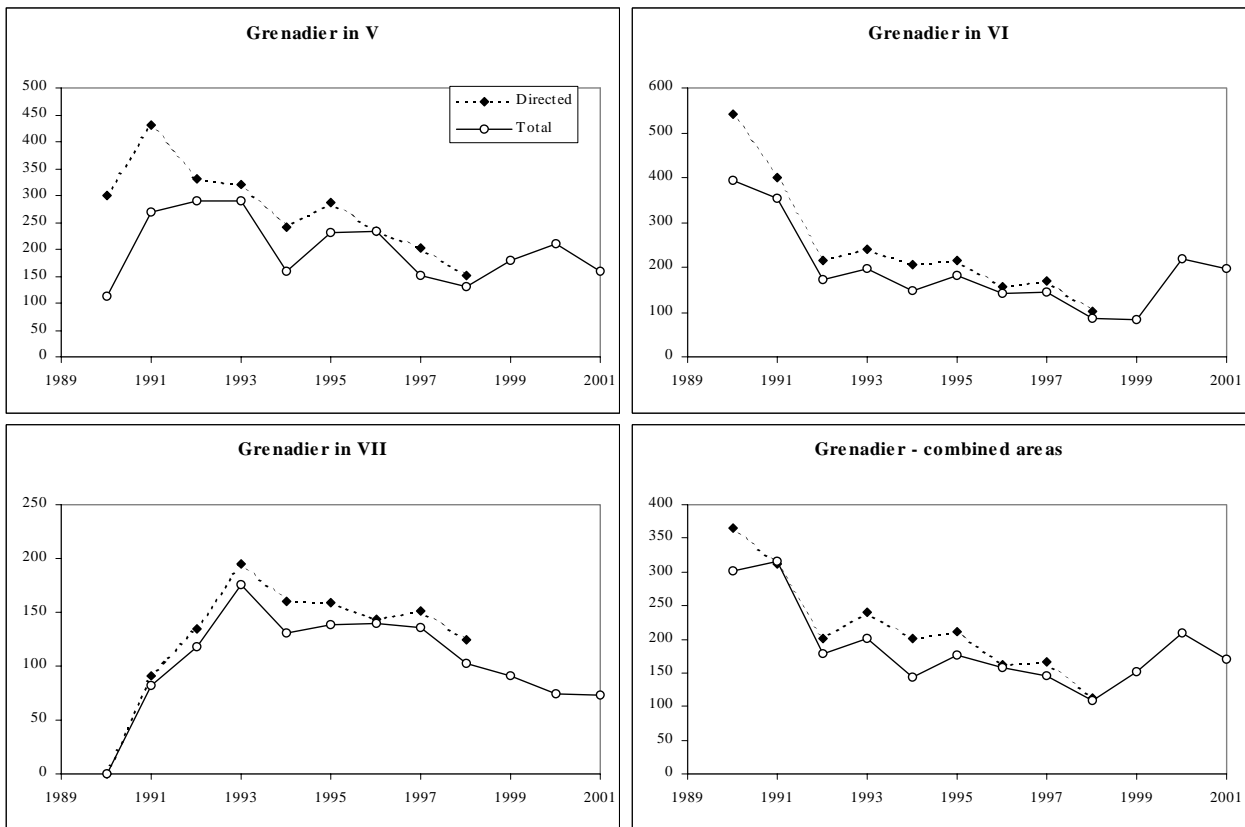

Figure 12.1 Comparison of the time series of the directed CPUE used by SGDEEP in 2000 and the total CPUE used in the present report.

13 BLACK SCABBARDFISH (*APHANOPUS CARBO*)

13.1 Catch trends

Table 13.1 gives the landings data for Black Scabbardfish, *Aphanopus carbo*, by ICES Sub-Area either as reported to ICES or as Working Group estimates. Only the landings from French trawlers in ICES areas VI and VII and the Portuguese long-liners in Sub-area IXa exceed 1000 t.

Considering all ICES Sub-areas, there is a general increasing trend in Black scabbardfish landings, particularly pronounced in Sub-areas VI and VII. This increase is mainly due to the French landings although in the two most recent years there was also a considerable increase in Scottish landings (Table 13.1).

French landings increased until 1993, remained stable until 1996 and sharply decreased until 1998. Since then landings have increased again showing a sharp increase in the last two years. This pattern largely reflects the French landings in ICES Sub-areas VI and VII (Figure 13.1).

Portuguese landings from ICES Sub-area IX fluctuated around 3000 tons, showing a slight decreasing trend in recent years. However, this trend is not considered significant (Figure 13.2), see Figueiredo and Machado, (2002 WD).

Catches from ICES Sub-area X have fluctuated greatly over the years, mainly as a result of exploratory surveys carried out in this area. All landings were thus not taken in established fisheries.

13.2 Stock structure

There is very little objective information available on the stock structure of this species. The results from BASBLACK Project (Section 3.6.2) on stock discrimination are inconclusive.

13.3 Commercial catch and effort data

French trawl CPUE data for Vb, VI and VII are available for the period 1991–2001 (Table 13.2 and Figure 13.3, see section 6.1.2 for a description of the French fisheries). Since SGDEEP 2000 there has been a change in the method of estimation of French CPUE for deep sea species including Black Scabbardfish. However, for the period 1990–1998 there seems to be little difference in the trends of CPUEs by the former method and the new method. The CPUEs show a gradual decline until 1998. This is particularly evident for ICES Sub-area VI, which represents a large part of the total international catch from the northern areas (Vb, VI, VII and XII). A sharp increase observed in CPUE in 2001 (Figure 13.4). There was some discussion on the interpretation of the French high CPUE for 2001 for this species, i.e. whether this value could be interpreted as indicator of increase in stock density or it merely reflected a change in exploitation pattern by the French fleets. The WG was of the opinion that the latter explanation seemed to be the most likely, as Black Scabbardfish has become an increasingly important target to the French trawlers.

The Portuguese long-line CPUE data are based on catch & effort information from random sampling of fishing vessels during the period 1991–2000 (Figueiredo and Machado, 2002 WD). The recorded annual landings of the sampled vessels as well as the landings of the whole fleet between 1991 and 2000 show similar trends (Figure 13.5). The mean CPUEs fluctuated over the years without any particular trend (Figure 13.6).

13.4 Length and Age compositions and mean weights at age

Information on the size composition by black scabbardfish in the NE Atlantic is presented by SGDEEP 2000 for the various fisheries exploiting this species, (ICES CM 2000/ACFM:08). There are differences in length structure of black scabbardfish between the northern and southern areas. However it is important to stress that those differences can to a large extent be explained by the different size selectivity patterns of the fishing gear used. Length data obtained during exploratory surveys performed by Portuguese longliners and Spanish trawlers in Subarea X emphasises the role of selectivity on such difference in the length composition of the catches from different fishing gears (Figure 13.7).

In recent years the mean lengths of black scabbardfish caught at ICES Subarea IXa did not differ from those landed at the beginning of this fishery (Fig 13.8). Length frequency distribution of black scabbardfish sampled in Sesimbra in 2000, as well as, the weight-length relationship are presented in Figures 13.9 and 13.10.

Length frequency distributions of black scabbardfish caught by Spanish commercial bottom trawlers at Hatton Bank (ICES Sub-areas VIa and XII) in 2001 are shown in Figure 13.11.

13.5 Biological parameters

The reproductive strategy and dynamics of black scabbard fish is not fully understood yet. Spawned eggs of black scabbardfish have never been found, but a few larvae were taken in samples taken off the Azores (Vinnichenko, 2002). In general juvenile fish (recruits) are rare in catches.

Mature fish (spawners) are found in catches from Madeiran waters, where spawning takes place from November to December (Morales-Nin and Sena-Carvalho, 1996). However, in Madeiran waters there appears to be no seasonality in the occurrence of juveniles, which are found in small numbers throughout the year (Morales-Nin and Sena-Carvalho, 1996). This lack of seasonality in juvenile occurrence may be ascribed to a complex stock structure. Spawners have also been observed around the Azores from November to April (Vinnichenko, 2002). Earlier Russian data from the Hatton Bank also reported spawning fish from November to April (Zilanov and Shepel, 1975). At the Rockall Trough there is a weak indication that juveniles enter this region during the last quarter of the year.

Recent histological studies have clarified the problems associated with maturity stage assignments. They indicate a predominance of immature specimens landed in Sesimbra (ICES Sub-area IXa) even among the large specimens. It seems that in this region only few specimens reach early maturity condition, and among these early developing females most of them exhibit atresia in their ovaries (Bordalo *et al.*, 2001).

Age estimates (unvalidated) suggest that the black scabbardfish has a relatively high growth rate and a longevity of about 12 years (Morales-Nin *et al.*, 2002). Estimates Von Bertalanffy growth parameters based on whole otolith readings were: $L_{inf} = 132.6$ cm; $k = 0.177$; $t_0 = -1.793$. Those age estimates were consistent with the growth estimates based on otolith daily increments (Anon., 2000).

Considerable variability in otolith shape has been observed between different geographic areas. This has not yet been further investigated, but could be related to the existence of a complex stock structure or to migratory behaviour associated with species' spatial distribution (Morales-Nin *et al.* in press).

Variable	Value	Source/comment
Longevity (years)	12	Morales-Nin <i>et al.</i> , in press
L_{inf} (cm)	132.6	Anon, 2000
Growth rate, K	0.177	Anon, 2000
Natural mortality, M	.17 (V, VI, VII, VIII)	(Martins <i>et al.</i> , 1989)
Length of 1 st capture	110 long-liners, sub-area IX	Figueiredo and Bordalo Working Document 2002
Length at first maturity	103	Anon, 2000
Spawning season(s)	Sept. – Febr. (Madeiran waters)	Anon, 2000
Age at first maturity (years)	7	Anon, 2000

13.6 Assessment

Given the lack of conclusive stock discriminatory data the WG agreed to use the following separate assessment units until such time that stock structure is properly elucidated:

Sub-areas V,VI,VII and XII

No assessment is presented for this stock component. The recent trend in French CPUE series and the lack of other relevant information render the output from the assessment models (DeLury and Schaefer) unreliable.

Sub-area VIII and IX

An assessment was attempted with both a modified DeLury constant recruitment model and a Schaefer surplus production model. The data used in the assessment comprised total international catch data for Sub-areas VIII and IX from 1990 to 2000, where the majority of landings are taken in Sub-area IX a by the Portuguese longliners. However the corresponding CPUE data from the Portuguese longline are very uniform with no trends, and the fit from both DeLury and Schaefer was poor. The results are considered unreliable and not presented.

13.7 Management considerations

The French trawl CPUE shows a consistent decline to a historically low level in 1999, a slight increase in 2000 and then a very considerable increase in 2001. While it is possible that this represents some improvement in stock status, it is highly unlikely that the magnitude of the increase between 2000 and 2001 can be explained by changes in stock size. Therefore any consideration for change in management advice for this species in V, VI, VII & XII should be treated with caution.

Based on the stable CPUE data from the long-liners in Sub-area IXa, the abundance in this area appears to have remained relatively stable during the past decade. This stability should be taken into consideration when giving management advice for the fishery in this area.

In the Azorean EEZ (ICES Sub-area X) there are no special management recommendations since the fishery is not yet developed beyond an exploratory stage.

In some ICES Sub-areas black scabbardfish is taken as by-catch of mixed fisheries.

Table 13.1 Black Scabbardfish. Study Group estimates of landings by ICES Sub-areas.Black Scabbardfish (*Aphanopus carbo*) III and IV

Year	France	Germany	UK(Scotl)	UK(EWNI)	Total
1988	2				2
1989	0				0
1990	57				57
1991	0				0
1992	0				0
1993	0				0
1994	13	3			16
1995			2		2
1996	3		1		4
1997	0		2		2
1998			9		9
1999	4		3		6
2000	2	0	3		5
2001	1	0	10	1	12

Black Scabbardfish (*Aphanopus carbo*) Va

Year	Iceland	Total
1988		0
1989		0
1990		0
1991		0
1992		0
1993	0	0
1994	1	1
1995	+	+
1996	0	0
1997	1	1
1998	0	0
1999	9	9
2000	18	18
2001	8	8

Black Scabbardfish (*Aphanopus carbo*) Vb

Year	Faroes	France	Germany	UK(Scot)	UK(EWNI)	Total
1988						0
1989		166				166
1990	12	407				419
1991	1	151				152
1992	4	29				33
1993	202	76		9		287
1994	114	45		1		160
1995	249	175				424
1996	57	129				186
1997	18	50				68
1998	36	144				180
1999	31	135		6		172
2000	117	186		0	9	313
2001	228	371		0	20	620

Table 13.1 (cont.)Black Scabbardfish (*Aphanopus carbo*) VI and VII

Year	Faroes	France	Germany	Ireland	Spain	UK(Scot)	UK(EWNI)	Total
1988								0
1989	46	108						154
1990		1060						1060
1991		2759						2759
1992	3	3433						3436
1993	62	3411	48	8				3529
1994		3050	46	3		2		3101
1995		3257	3			18		3278
1996		3650	2			36	1	3689
1997	3	2754		0	1	235	2	2995
1998		1815		0	3	148	1	1967
1999		1973		1	0	191	1	2166
2000		3235	0	59	1	377	40	3712
2001		3692	0	68	158	673	38	4625

Black Scabbardfish (*Aphanopus carbo*) VIII and IX

Year	France	Portugal	Spain	Total
1988		2602		2602
1989		3473		3473
1990	0	3274		3274
1991	1	3978		3979
1992	0	4389		4389
1993	0	4513		4513
1994	0	3429		3429
1995		4272		4272
1996	126	3686	3	3815
1997	2	3553	1	3556
1998	2	3147	3	3152
1999	11	2741	0	2752
2000	32	2371	1	2404
2001	22	2744	1	2767

Black Scabbardfish (*Aphanopus carbo*) X

Year	Faroes	Portugal	France	Total
1988				0
1989				0
1990				0
1991		166		166
1992	370			370
1993		2		2
1994				0
1995		3		3
1996	11	0		11
1997	3	0		3
1998	31	68		99
1999		46	66	112
2000		112	1	113
2001		0	0	0

Table 13.1 (cont.)Black Scabbardfish (*Aphanopus carbo*) XII

Year	Faroes	France	Germany	Spain	UK(Scot)	Total
1988						0
1989						0
1990						0
1991						0
1992		512				512
1993	1051			93		1144
1994	779			45		824
1995	301					301 *Faroes includes VIb Hatton
1996	187	4		253		444
1997	102			98		200
1998	20			134		154
1999		3		109	0	112
2000	1	6	0	237		244
2001	2	3	0	159		164

Black Scabbardfish (*Aphanopus carbo*) XIV

Year	Faroes	Spain	Total
1988			0
1989			0
1990			0
1991			0
1992			0
1993			0
1994			0
1995			0
1996			0
1997			0
1998	2		2
1999			0
2000		90	90
2001		12	12

Black Scabbardfish (*Aphanopus carbo*) All ICES areas

	III+IV	Va	Vb	VI+VII	VIII+IX	X	XII	XIV	Total	
1988	2	0	0	0	0	2602	0	0	0	2604
1989	0	0	0	166	154	3473	0	0	0	3793
1990	57	0	0	419	1060	3274	0	0	0	4810
1991	0	0	0	152	2759	3979	166	0	0	7056
1992	0	0	0	33	3436	4389	370	512	0	8740
1993	0	0	0	287	3529	4513	2	1144	0	9475
1994	16	1	1	160	3101	3429	0	824	0	7531
1995	2 +			424	3278	4272	3	301	0	8280
1996	4	0	0	186	3689	3815	11	444	0	8149
1997	2	1	1	68	2995	3556	3	200	0	6825
1998	9	0	0	180	1967	3152	99	154	2	5563
1999	6	9	9	172	2166	2752	112	112	0	5329
2000	5	18	18	313	3712	2404	113	244	90	6900
2001	12	8	8	620	4625	2767	0	164	12	8207

Table 13.2 Black Scabbardfish. International catches and French total catch and effort for the two series in ICES Sub-areas Vb, VI, and VII.

ICES sub-area	Year	international catch (t)	SG00 cpue (kg/h)	WG02 Catch (t)	effort (h)	cpue (kg/h)
V	1990	419	144.77	407	9354	43.51
V	1991	152	238.34	131	4320	30.32
V	1992	33	154.78	99	2321	42.65
V	1993	287	217.57	73	1137	64.20
V	1994	161	82.1	44	1288	34.16
V	1995	424	221.3	175	1992	87.85
V	1996	186	113.78	128	2053	62.35
V	1997	69	67.89	50	3373	14.82
V	1998	180	85.16	144	6105	23.59
V	1999	181		127	10119	12.55
V	2000	331		173	7961	21.73
V	2001	589		354	10336	34.25
VI	1990	1023	249	846	5521	153.23
VI	1991	2290	292.99	1220	8634	141.30
VI	1992	3111	280.31	1537	8373	183.57
VI	1993	3045	238.74	1312	9088	144.37
VI	1994	2427	195.65	1262	9222	136.85
VI	1995	2633	113.74	722	10129	71.28
VI	1996	3024	99.02	947	11244	84.22
VI	1997	2532	96.41	572	10028	57.04
VI	1998	1611	73.56	462	9347	49.43
VI	1999	1809		191	6027	31.69
VI	2000	3087		507	9914	51.14
VI	2001	3839		857	5702	150.30
VII	1990	10	0	0	21	0.00
VII	1991	93	67.8	51	3107	16.41
VII	1992	322	52.61	204	8882	22.97
VII	1993	484	84.16	229	5666	40.42
VII	1994	673	103.12	358	7695	46.52
VII	1995	645	89.96	425	6401	66.40
VII	1996	665	91.14	368	4042	91.04
VII	1997	460	68.81	143	2685	53.26
VII	1998	356	73.51	155	3076	50.39
VII	1999	355		105	2992	35.09
VII	2000	577		89	2615	34.03
VII	2001	789		221	2067	106.92
Combined	1990	1452	172.22	1253	14896	117.59
Combined	1991	2535	227.26	1402	16061	126.39
Combined	1992	3466	183.64	1840	19576	158.18
Combined	1993	3816	168.85	1614	15891	125.99
Combined	1994	3261	144.82	1664	18205	114.70
Combined	1995	3702	102.02	1322	18522	71.90
Combined	1996	3875	89.01	1443	17339	84.02
Combined	1997	3061	77.44	765	16086	53.57
Combined	1998	2147	67.07	761	18528	44.73
Combined	1999	2345		423	19138	26.79
Combined	2000	3995		769	20490	42.54
Combined	2001	5216		1432	18105	114.92

Table 13.3 Black Scabbardfish. CPUE mean estimates +/- stand.dev. for the Portuguese longline (ICES Subarea IXa)

Year	CPUE Mean+sd (Kg/hook)	Mean-sd (Kg/hook)	Mean (Kg/hook)
1990	0.19	0.14	0.16
1991	0.26	0.05	0.15
1992	0.28	0.15	0.21
1993	0.27	0.14	0.20
1994	0.32	0.11	0.21
1995	0.35	0.16	0.26
1996	0.33	0.14	0.24
1997	0.27	0.14	0.20
1998	0.22	0.15	0.18
1999	0.32	0.13	0.22
2000	0.28	0.10	0.19



Figure 13.1- French landings evolution from 1988 till 2001.

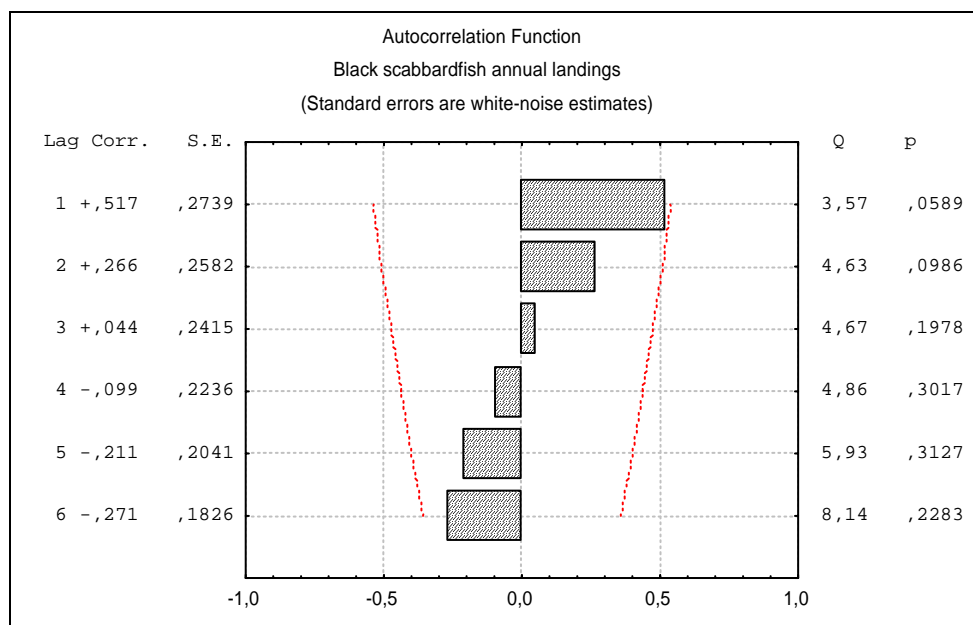

Figure 13. 2 – Results from the autocorrelation function on annual Portuguese landing values (ICES Subarea IXa) between 1991 and 2000. The dashed lines enclose the area of no significant correlation.

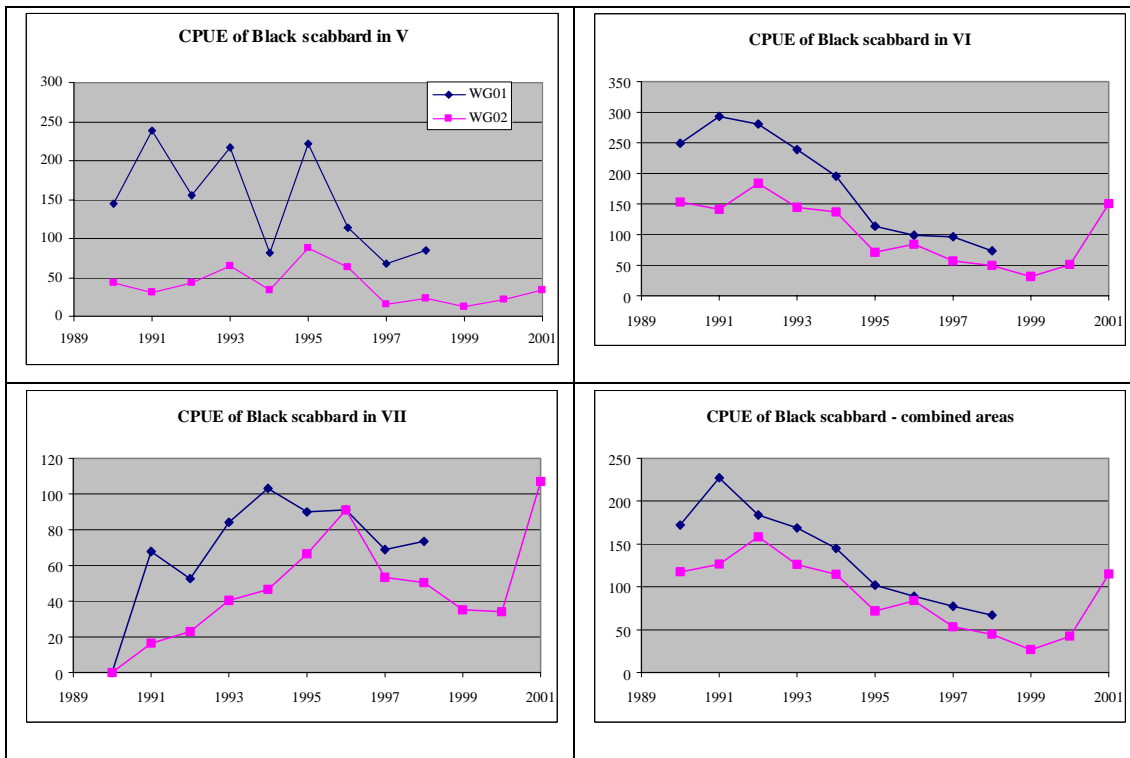

Figure 13.3 - French trawl CPUE data series for ICES Sub-areas V, VI, VII and for the whole combined areas.

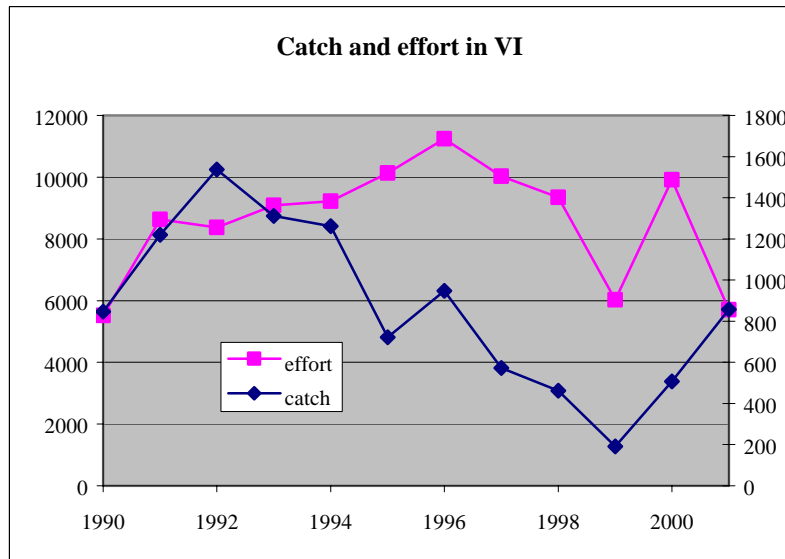

Figure 13.4 - French trawl catch and effort data series for ICES subarea VI.

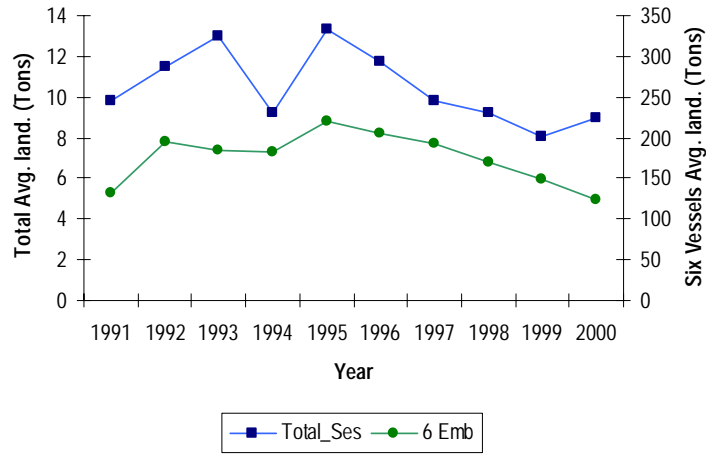

Figure 13.5 – Black scabbardfish average annual landings in Sesimbra from the whole fleet (Total_Ses) and from six representative vessels (6 Emb), (1991-2000)

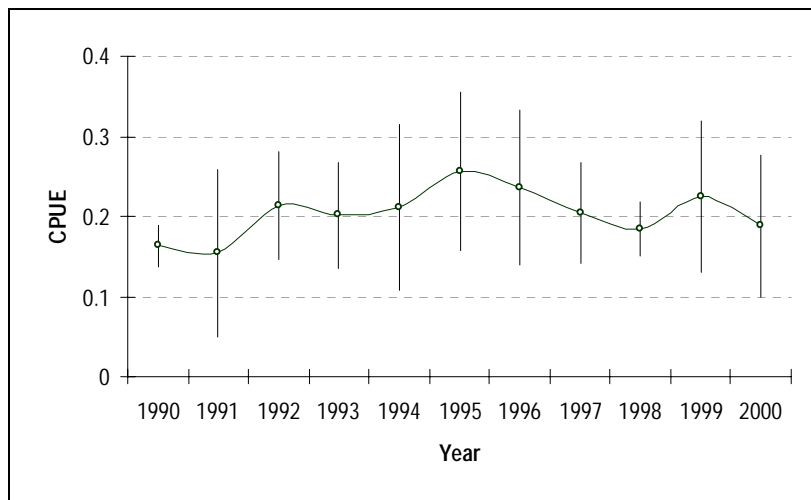

Figure 13.6 - Annual CPUE average estimates (1990 and 2000). Black bars indicate mean variation interval (mean ± st. deviation).

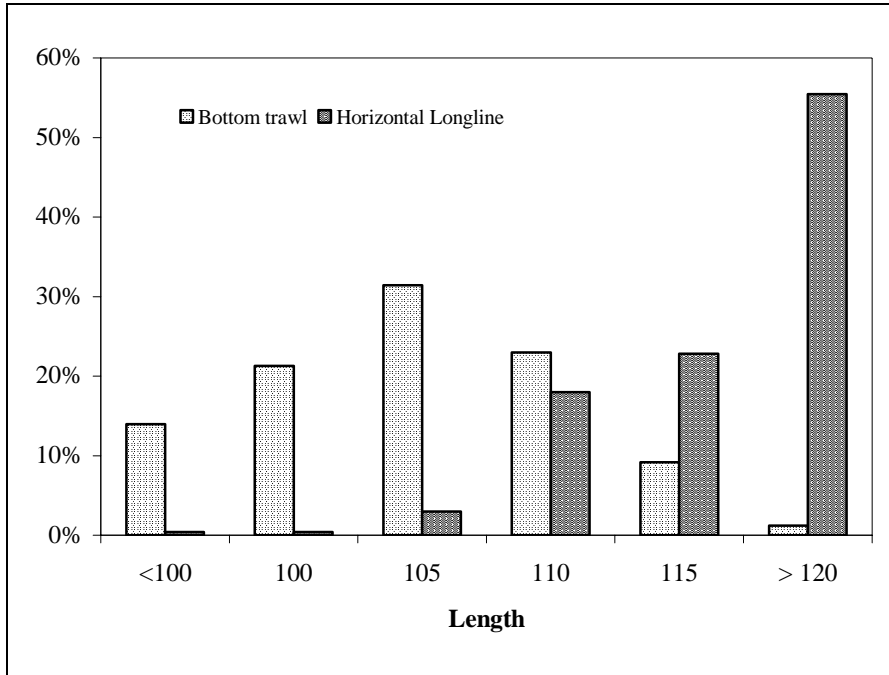

Figure 13.7 - Length distribution of black scabbardfish caught by bottom trawl and by horizontal longline in ICES Sub-area X (ANON., 2000).

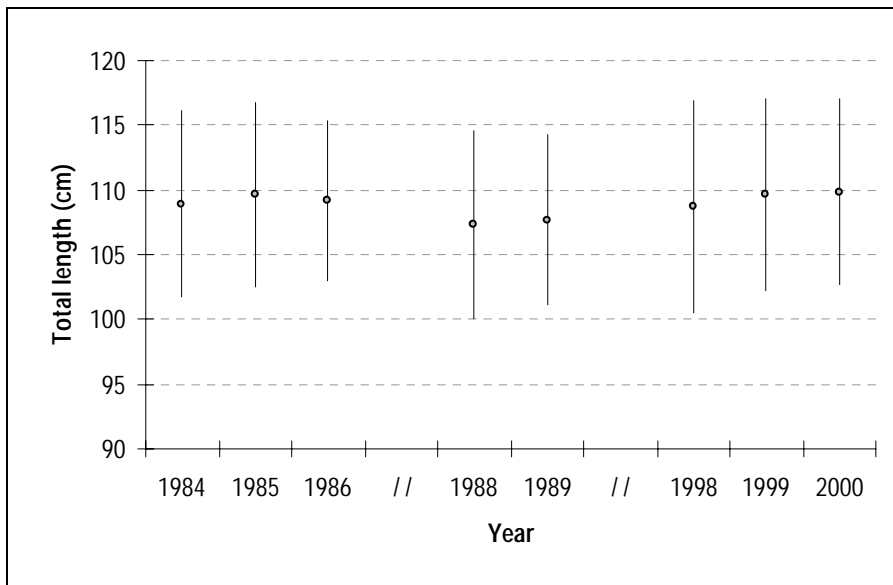

Figure 13.8 - Black scabbardfish total mean length estimates in three time periods 1984-1986, 1988-1989 and 1998 and 2000 (ICES Sub-area IXa) Black bars indicate mean variation interval (mean \pm st. deviation).

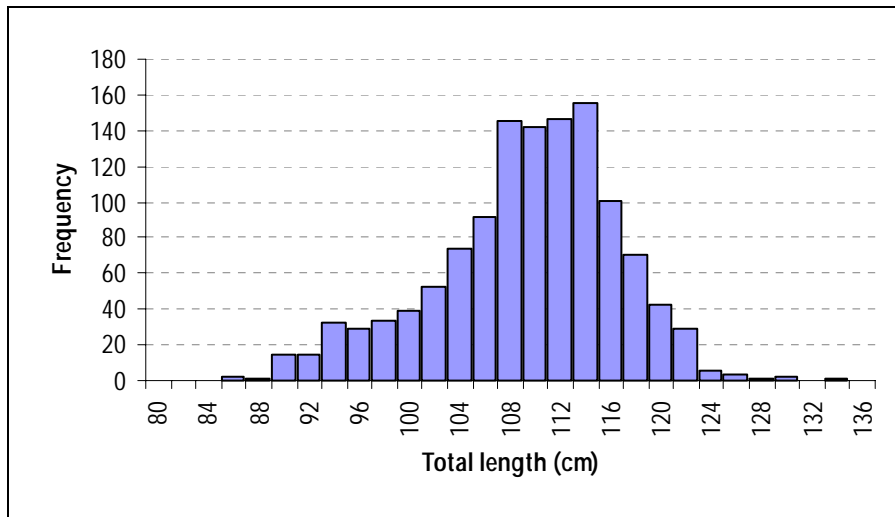

Figure 13.9 - Length frequency distribution of black scabbardfish caught by longliners from Sesimbra (ICES Sub-area IXa) during 2000.

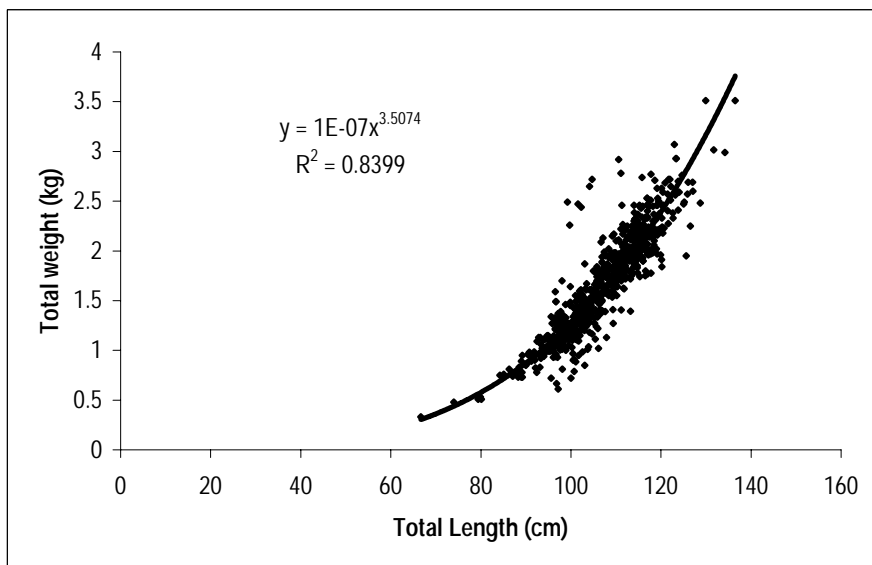

Figure 13.10- Weight/length relationship of black scabbardfish caught by longliners from Sesimbra (ICES Sub-area IXa).

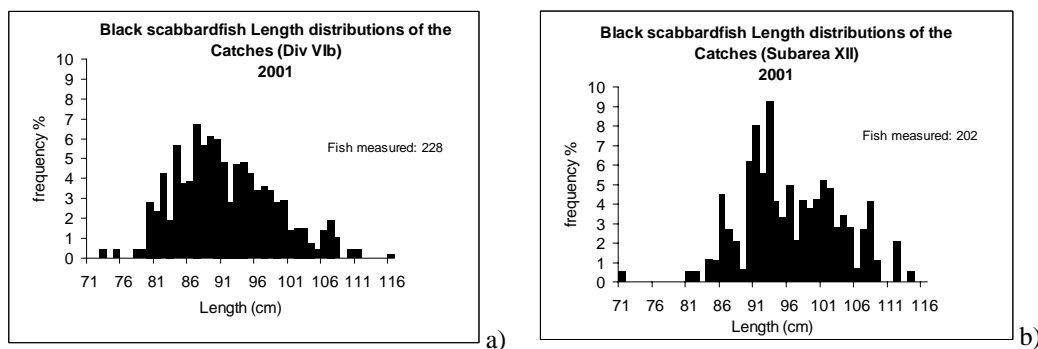

Figure 13.11 - Length frequency distribution of black scabbardfish caught by bottom commercial Spanish trawlers carried during 2001 in ICES Sub-area Vb (no. of samples = 2; no. of individuals=228) a) and in ICES Sub-area XII (no. of samples = 4; no. of individuals=204) b).

14 RED (=BLACKSPOT) SEABREAM (*PAGELLUS BOGARAVEO*)

14.1 Catch trends

Landings data for red (blackspot) seabream, *Pagellus bogaraveo*, by ICES Sub-areas/Divisions as reported to ICES or to the Working Group are shown in Table 14.1. No data on discards of this species have been presented to the Group.

Landings in the Sub-areas VI, VII and VIII, from France, Portugal, Spain and UK peaked at more than 24 000 t in 1974 (ICES C.M.1998/Assess:8) but then declined. Some of the high historical catches could be misreported as they included some other species of *Pagellus* and/or other *Sparidae*, i.e. “seabream” in general. A more detailed study of official international catches by country in Sub-area VI+VII+VIII indicated that about 7 000 t were landed in 1979 and then there was a decrease to 2 100 t in 1985 (ICES C.M.1996/Assess:8). In Table 14.1 landings in the Sub-areas VI, VII and VIII are given for 1988 onwards. In this period landings fell from more than 461 t in 1989 to 52 t in 1996, but since 1997 they have increased continuously until 2000 (287 t). For 2001 the landing has been estimated to 220 t. This trend is most marked in Sub-area VIII. There are also some differences in the trend between countries. In the last years (1997-2000) the trend described is evident for France and Spain in Sub-area VIII, but it is not so synchronic for France, Ireland, Spain and UK in Sub-area VII, where since 1989 the catches are traditionally much lower. It is clear that, when the present landings are compared with those obtained 20 and more years ago, the red seabream fishery seems to continue in a “quasi depleted” situation. It is uncertain if the recent increase is the beginning of recovery. Most of the red seabream catches in this area, at present almost all by-catches, are taken by the longliner fleet, but trawlers also occasionally land this species. In the period considered (1988-2001), most of the estimated landings from this area were taken by Spain (69%), followed by UK (16%), France (13%) and Ireland (3%).

Also in Sub-area IX most of the catches in 1988-2001 were taken by longliners, primarily the Spanish (more than 70%) and Portuguese fleets. Spanish landings data from this area are available from 1983 and Portuguese from 1988 onwards. The maximum catch in this period was obtained in 1993-1994 and 1997 (about 1 000 t) and the minimum in 2000 (421 t) and 2001 (375 t), but the 2001 value is preliminary. Since 1998 a constant decreasing landings trend is observed. Almost all Spanish catches in this area are taken in waters close to the Gibraltar Strait (Southern Div. IXa). They show an increasing tendency since 1983 (101 t) until 1994 (854 t), then they remain in a rather high level but since 1998 the landings have decreased reaching in 2001 the minimum (220 t) of all the 1988-2001 period. However in the northern Div. IXa (Galicia) the Spanish landings have increased since 1998 (1 t) to 2001 (58 t). In the Portuguese landings no clear tendency is observed but in the two last years landings were the lowest in the period (83 t in 2000 and 97 in 2001).

Landings data in Sub-area X (Azores) are available from 1982 onwards; they have ranged from 369 t (in 1982) to a maximum of 1222 t (in 1999). In 2000 and 2001 947 t and 1034 t were landed. No clear trends can be observed in the landings of the last ten years in this area. All catches were taken by the Azorean fleet and mainly by longline. (See Section 14.2.1 for a more complete description of this fishery).

In Sub-area XII, landings data are available from only one year (1994). They amount to 75 t and were reported by Latvia.

When the historical landings series for the three areas (VI+VII+VIII, IX and X) are compared, a rather surprising feature is observed (Figure 14.1). Sub-areas VI+VII+VIII and Sub-area IX shows in the last four years (1998-2001) an opposite tendency. A similar opposite pattern, was seen at the beginning of the 1990s. However, in Sub-area X no clear landings trends are observed in relation to the other two sea areas.

14.2 Stock structure

Information on red (blackspot) seabream, *P. bogaraveo*, has been split into three different components, as referred to in the previous Reports (ICES C.M.1996/Assess:8; ICES C.M.1998/ACFM:12; ICES C.M. 2001/ACFM:23):

- *P. bogaraveo* in Sub-areas VI, VII and VIII
- *P. bogaraveo* in Sub-area IX
- *P. bogaraveo* in Sub-area X (Azores region)

This separation does not pre-suppose that there are three different stocks of *P. bogaraveo*, but it offers a better way of recording the available information. The inter-relationships of the red seabream from the Sub-areas VI, VII, VIII and the northern part of Division IXa, and their migratory movements within these areas have been described in the past by tagging methods (Gueguen, 1974; ICES, C.M.1996/Assess:8). Possible links between red seabream of the Azorean region with the southern Sub-area IX, Moroccan waters, Sahara Bank and Sub-areas VI+VII+VIII and the northern part

of Division IXa have not been studied extensively. However, recent genetic studies show that there are no differences between populations from different ecosystems within the Azores region (Eastern, Central and Western group of Islands, and Princes Alice bank) but there are genetic differences between Azores (ICES area X) and mainland Portugal (ICES area IXa) (Menezes *et al.*, 2001).

Thus, due to the very different present status of the red seabream fishery in the three areas and the current scientific information on migration and genetics relevant to each, it has been considered appropriate to continue to present the following chapter split by area.

14.2.1 *P. bogaraveo* in the Azores region (Sub-area X)

In the Azorean waters (Sub-area X) three phases can be described in the development of the target fishery of red seabream (Figure 14.2). In the Predevelopment phase (1948-1971) a traditional fishery was carried out by small open-deck boats (<12 m). These operated near the coast, using mainly handline gears, obtaining small (<100 t by year) and selective catches. The second or Growth phase (1972-1991) was characterised by an important development of the fishery with the introduction of the bottom longline gear and new fishing vessels (longliners >12 m and < 30 m). As a consequence new species and new fishing areas and depths were explored, new markets were developed, and an abrupt increase in the total demersal catches, namely in the red seabream catches (400-900 t), as well in the fishing effort were observed. In the third or Full exploited Phase (1992 onwards) the fishery is characterized by a specialization of different vessels, relative to the fishing areas, depth, season, gears and species. In this phase a red seabream annual catch averaged 1000 t during the last decade, peaking at 1200 t in 1999.

Fishing effort increased until 1993 and fluctuated thereafter but total catches continued at an average value of 1000 t since 1992 (Figure 14.3). Variability on fishing effort may reflect specialization of vessels relative to the fishing areas, depth, season, gears and species. Whether the multispecies effects mask the observed trend is unresolved. However, target red (blackspot) seabream fishing effort is considered high since 1995. Thus, as a result, during 1998 an indirect measure to control effort was introduced, limiting the annual licence to those boats that do not land above a minimum threshold amount in value. During 2000 some additional technical measures, including hook size limit and fishing area restriction by vessel size and gear type, were also implemented.

14.2.1.1 Commercial LPUE and Research Surveys

Longline survey CPUE for the period 1995 to 2000 and the commercial CPUE (LPUE) for the period 1986 to 2000 are presented in Figure 14.4. Commercial CPUE decrease from 1986 to 2000 but with fluctuations along time. Similar trend is observed in the survey CPUE. Observed short-term variability cannot be explained only by fishing mortality or recruitment, suggesting environment effects or fish movement between the different habitats (coasts of islands, banks and seamounts).

14.2.1.2 Length and Age compositions

Length composition is available for the period 1985-2000. Age reading has been updated annually since 1995, using data from surveys. However, otoliths are often not collected in conjunction with the length sampling from commercial landings. Mean length-at-ages from otoliths are available from the fishery only for the periods 1982-1985 and 1987-1991. Age composition from the commercial fishery and surveys were estimated by slicing length compositions (Figure 14.5 and Figure 14.6). The commercial age composition seems to maintain the distribution along the period with modes in the ages 2 and 3. Age composition from surveys seems also similar. Age distribution from longline survey indicates that the proportion of large fish has increased since 1997 (Figure 14.6).

14.2.1.3 Biological parameters

Red seabream is characterized by its protandric hermaphroditism, males being more abundant in small size ranges (10-30cm), females being more abundant in large sizes (above 35cm) and hermaphrodites at intermediate sizes (25-40cm). The sex change may occur after spawning (during spring and summer) (Krug, 1990, 1998) (Figure 14.7).

Mean length-at-ages from direct readings of otoliths are available from the fishery only for the periods 1982-1985 and 1987-1991. Age data have been collected annually from surveys (1995, 1996, 1997, 1999, 2000 and 2001), following a stratified sampling by station, area, depth and length. Specimens from age 0 to 15 (10-55 cm FL) years were found.

Von Bertalanffy growth parameters for both sexes combined were estimated (M. Pinho, *pers.com.*), pooling mean length-at-age (fork length (LF) in cm) from the fishery and survey data (Figure 14.8).

$$LF_{cm} = 62.24 * [1 - e^{-0.102 * (t - 1.29)}]$$

A length-weight relationship (fork length (LF) in cm and total weight (W) in g) was also fit to *Pagellus bogaraveo* for sex combined, pooling fishery and survey data (M. Pinho, *pers.com.*):

$$\text{Weight} = 0.0198 * LF^{2.98} \quad (n = 3712; r^2 = 0.9884)$$

A weight-at-age relationship was then estimated (M. Pinho, *pers.com.*) combining the age-length and length-weight relationships:

$$Wt_g = 4491 * [1 - e^{-0.102 * (t - 1.292)}]^{2.985}$$

An annual reproductive cycle is defined for the species with spawning occurring between January and March. Mature males are found from November to March and females from December to March (Krug, 1998, Menezes *et al.*, 2001).

Significant changes on female age of first maturity and sex ratio along time have been observed (Krug, 1994; Estacio *et al.*, 2001) (Figure 14.9 and Figure 14.10). Reduction of age of first maturity may be a response to the fishing pressure in order to maintain the proportion of females constant as suggested by Krug (1994). The reduction of female sex ratio is more difficult to interpret.

14.2.1.4 Assessment

An age-based assessment (XSA) was attempted using commercial catch at age, weights at age and maturity rates at age data from 1986-2000. The VPA was calibrated with age-disaggregated commercial longline CPUE data (1986-2000) and survey longline catch rates at age (1995-2000 except 1998). Although age compositions included fish up to 15 years old, ages 10-15 years were collapsed into a plus group since they contributed little to the overall catches. The average weight at age for ages 10-15 was used to represent the 10+ group. Maturity proportions at age were based on mature females as a proportion of the entire population at age. The average maturity rate at age for ages 10-15 was used to represent the 10+ group. The above input data are shown in Table 14.2 and 14.3. A natural mortality rate of 0.20 was used for all ages in the analysis.

14.2.1.5 Biological reference points

As the Working Group attempted but finally carried out no assessment, no biological reference points have been considered.

14.2.1.6 Comments on the assessment

Following a variety of formulations of the objective function it was shown that the calibration indices in their present form did not contribute greatly to population estimates of survivors for the major age groups that contribute to the fishery. The statistical diagnostics also indicated that there were severe violations in many of the model assumptions. Therefore no detailed results were presented here. Nevertheless, the Group considered that there is considerable merit in pursuing an age-based assessment for this stock when time is available to reflect on better formulations of the assessment model. These should be based on what is known about the main characteristics of the stock such as its biological features (growth and maturity), distribution and migration patterns as well as fishing strategies that are important in assessing it more accurately.

14.2.1.7 Management considerations

The inability of the models to correctly model at present the fluctuations in CPUE data observed in Sub-area X implies that we cannot draw any firm conclusions about the state of the stock in this area from these methods of stock assessment at the current time.

14.2.1.8 *P. bogaraveo* in Sub-area IX

An new description of the Spanish fishery in the southern part of Div. IX, i.e., close to the Strait of Gibraltar, has been presented to the Study Group by Gil *et al.* (WD 2002). This description updates the information offered in the past working group (Gil *et al.*, 2000). In Figure 14.11 the red seabream landings by their three components in the Sub-area IX in the period 1988-2001 is shown.

Description of the Spanish fishery in southern Division IXa

Since the early 1980s an artisanal longline fishery targeted red seabream (*Pagellus bogaraveo*, “voraz”) has been developed along the Strait of Gibraltar area (Figure 14.12). Actually this fishery covers almost all the Spanish landings for the species in the Div. IXa. The “voracera”, a particular mechanised hook and line baited with sardine, is the gear used by the fleet. The base ports of the boats involved in this fishery are only two: Algeciras and mainly Tarifa (Cádiz, SW Spain). Fishing is carried out taking advantage of the turnover of the tides in bottoms from 200 to 400 fathoms. Usually landings are distributed in categories due to the wide range of sizes and to market reasons. These categories have varied in time.

In the beginning of the 1980s, there were 25 small boats engaged in this fishery. Thereafter the fleet has increased to more than a hundred since the 1990s. The mean technical characteristics of this fleet by port, in 1999, are as below:

Port	Length (m)	G.T.R. (t)	N
Tarifa	8.95	5.84	79
Algeciras	6.52	4.00	28

The decline of the landings after 1997 caused a serious concern by the fishermen and the authorities. Thus a study project on monitoring this fishery was planned and carried out by the *Instituto Español de Oceanografía* (IEO) at the request of the Fishermen Corporations. Moreover, some technical measures have been set up by the Spanish Central Government, in 1998, and by the Regional Government of Andalucía in 1999, in order to regulate the fishing activity and to conserve the resource. Among the technical measures adopted by this Fishing Plan there are: to closure of the fishing season during two months (February - March), maximum number of lines per boat (30), hook size and maximum number per line (100), maximum number of automatic machines for hauling per boat (3), minimum size of fish retained or landed (25 cm total length). Recently, in the past December 2001, the EU Commission considered the proposal of establishing a TAC of 577 tonnes for Spain in ICES IXa Sub-area.

14.2.1.9 Commercial CPUE and Research Surveys

To estimate the commercial landings per unit effort (LPUE) fishery information was gathered from the sale sheets for the period 1983-2001: monthly landings, monthly number of sales, number of days where sales were carried out and number of fishing boats that at least once per month landed fish.

The number of sales was chosen as unit of effort because it represents the number of daily trips for fishing (without consideration that boats could have made catches or not in that day). Hence, the LPUE is estimated as:

$$LPUE = \sum Landings(kg) / \sum Sales$$

The results on the LPUE development in the period 1983-2001 are presented in Figure 14.13. Since 1994 landings have been decreasing, except in 1996 and 1997, to the minimum value of 220 t in 2001. The average value for the three last years is 270 t. Fishing effort increased, however, in number of fishing units. There were also significant technological improvements (automatic machines for hauling the gear, echosounders, GPS etc.).

14.2.1.10 Length and Age compositions

From the beginning of the IEO monitoring, in June 1997, an *ad hoc* monthly sampling program on the different commercial sizes has been carried out to estimate the length composition of the landings. Annual length compositions of landings for the period 1984-1996 were estimated by applying the standard length distribution obtained from each of the commercial categories in the monitored years to the annual landings split by categories of that period.

The annual length composition of the Spanish landings in the years 1983-2001 is presented in Figure 14.14. There has been a decreasing mean length, mainly since 1995 to 1998. It is necessary to point out that the species probably does not have a homogeneous geographic and bathymetric distribution with length. This fact could explain the different mean catch landed between ports. The mean length of the landings has increased since 1999 after the introduction of the technical measures of the Fishing Plan.

14.2.1.11 Biological parameters

For the biological characterisation of the fishery, a monthly sampling programme has been carried out on commercial landings in two periods: from June 1997 to June 1998 and from November 1998 to February 1999. The last was especially targeted on smaller fish. In addition, three tagging surveys were carried out in August 1997 and 1998, and March 2001. The main results are presented below:

Length-weight relationship

The relationship between total length (cm) and total weight (g) of *Pagellus bogaraveo* in this area can be described by the following equation:

$$\text{Weight} = 0.014 * L^{3.014} \quad (n = 1042; r^2 = 0.99)$$

Age and growth

Sagittae otoliths (>700) have been used for age determination and a synthetic age-length key (ALK) was obtained in an annual basis for all the period considered (1997-1999). In the Table below the mean total lengths at age, the standard deviation and coefficient of variation at age are presented.

Age (years)	0	1	2	3	4	5	6	7	8
Mean length (cm)	12.4	17.3	22.4	28.7	33.1	35.3	40.9	44.0	49.9
St. Deviation	0.73	1.20	1.35	2.49	2.23	3.14	2.33	3.91	3.54
C. V.	0.06	0.07	0.06	0.09	0.07	0.09	0.06	0.09	0.07

The growth parameters were estimated according to the von Bertalanffy growth function for sex combined. The total L_{∞} value ($L_{\infty} = 58$ cm) was fitted from the largest total length of the monthly length distribution samples. The values obtained for the other growth parameters are: $t_0 = -0.67$ and $k = 0.169$; $r^2 = 0.98$ (Sobrinho & Gil, 2001).

$$L_{t_{\infty}} = 58 * [1 - e^{-0.169 * (t - (-0.67))}]$$

Reproduction

In the sampling period 1997-1999, 1042 fish were analysed.

Sex	Number	Length range (cm)
Unsexed	160	11-30
Males	318	24-50
Females	282	24-53
Hermaphrodites	282	20-54
Total	1042	11-54

According to the monthly series of GSI, the spawning season of red seabream in this area seems to take place during the first quarter of the year. The smallest specimens are mainly males, maturing at a $L_{50} = 30.1$ cm. Around 32-33 cm length a high proportion of the individuals changes sex. Females maturing at $L_{50} = 35.7$ cm. The number of eggs released per mature female (29 to 50 cm) per spawning event ranged from 25,712 to 1,821,188 with a mean value of 420,643 (Gil & Sobrinho, 2001).

Tagging

Preliminary results of the three tagging surveys conducted in 1997, 1998 and 2001 are summarised below.

Survey	Date	Gear type	Depth range	Tagged fish	Size range	Recaptures
Estepona 97	August 1997	Traps	43-103 m	1590	13-28 cm	109
Sotogrande 98	August 1998	Traps	43-103 m	1428	12-27 cm	17
Tarifa 01	March 2001	<i>Voracera</i>	179-485 m	979	21-52 cm	90

Recoveries obtained until now indicate in most cases that there were no important movements. However, juveniles tagged in the southern Mediterranean region moved to the west to the Strait of Gibraltar and also few fish moved from the Strait of Gibraltar to the Mediterranean. This seems to indicate a link between the Spanish south Atlantic and the western Mediterranean red seabream populations.

14.2.1.12 Assessment

The Study Group did not attempt an assessment of the red seabream of this area because there was insufficient information. It was a concern that it remains unclear if the measure of fishing effort fishing effort unit chosen provides a true reflection of the real effort.

14.2.1.13 Biological reference points

No biological reference points have been considered, because no assessment was carried out by the Working Group.

14.2.1.14 Comments on assessment

No comments because no assessment.

14.2.1.15 Management considerations

Although no assessment has been carried out, the decreasing trend observed in the landings and in their mean lengths might justify, from a precautionary point of view, the local technical measures adopted.

14.2.2 *P. bogaraveo* in Sub-areas VI, VII and VIII

Description of the trends of this at present by-catch fishery is given above (Ch 14.1).

14.2.2.1 Commercial CPUE and Research Surveys

No data were available to the Working Group.

14.2.2.2 Length and Age compositions

No data were available to the Working Group.

14.2.2.3 Biological parameters

No new biological parameters were available to the Working Group since the 1996 meeting of SGDEEP (ICES C.M.1996/Assess:8).

14.2.2.4 Assessment

Due to the lack of basic data, the Working Group attempted no assessment.

14.2.2.5 Biological reference points

As the Working Group carried out no assessment, no biological reference points have been considered.

14.2.2.6 Comments on assessment

No comments because no assessment.

14.2.2.7 Management considerations

In the Sub-areas VI, VII and VIII, there have for many years been no directed fisheries on *Pagellus bogaraveo* due to the very low yields obtained since the 1980s. Therefore most of the catches must be considered as very occasional by-catches of the fleets, mainly longliners, targeting other demersal species. For this reason, in spite of the obvious “collapse” situation of this traditional fishery, no special management considerations can be suggested.

Table 14.1 Red (=blackspot) seabream (*Pagellus bogaraveo*): Study Group estimates of landings (tonnes).**RED (=BLACKSPOT) SEABREAM (*Pagellus bogaraveo*) VI and VII**

Year	France	Ireland	Spain	E & W	Ch. Islands	TOTAL
1988	52	0	47	153	0	252
1989	44	0	69	76	0	189
1990	22	3	73	36	0	134
1991	13	10	30	56	14	123
1992	6	16	18	0	0	40
1993	5	7	10	0	0	22
1994	0	0	9	0	1	10
1995	0	6	5	0	0	11
1996	0	4	24	1	0	29
1997	0	20	0	36		56
1998	0	4	7	6		17
1999	0	8	0	15		25
2000	4	n/a	3	13		20
2001*	1	11	1	37		50

* Preliminary

RED (=BLACKSPOT) SEABREAM (*Pagellus bogaraveo*) VIII

Year	France	Spain	England	TOTAL
1988	37	91	9	137
1989	31	234	7	272
1990	15	280	17	312
1991	10	124	0	134
1992	5	119	0	124
1993	3	172	0	175
1994	0	131	0	131
1995	0	110	0	110
1996	0	23	0	23
1997	18	7	0	25
1998	18	86	0	104
1999	20	84	0	104
2000	81	187	0	268
2001*	11	159	0	170

* Preliminary

RED (=BLACKSPOT) SEABREAM (*Pagellus bogaraveo*) IX

Year	Portugal	Spain	TOTAL
1988	370	319	689
1989	260	416	676
1990	166	428	594
1991	109	423	532
1992	166	631	797
1993	235	765	1000
1994	150	854	1004
1995	204	625	829
1996	209	769	978
1997	203	808	1011
1998	357	520	877
1999	265	278	543
2000	83	338	421
2001*	97	278	375

* Preliminary

Table 14.1 continued**RED (=BLACKSPOT) SEABREAM (*Pagellus bogaraveo*) X**

Year	Portugal	TOTAL
1988	637	637
1989	924	924
1990	889	889
1991	874	874
1992	1110	1110
1993	829	829
1994	983	983
1995	1096	1096
1996	1036	1036
1997	1012	1012
1998	1114	1114
1999	1222	1222
2000	947	947
2001*	1034	1034

*Preliminary

RED (=BLACKSPOT) SEABREAM (*Pagellus bogaraveo*) XII

Year	Latvia	TOTAL
1988		0
1989		0
1990		0
1991		0
1992		0
1993		0
1994	75	75
1995		0
1996		0
1997		0
1998		0
1999		0
2000		0
2001*		0

* Preliminary

RED (=BLACKSPOT) SEABREAM (*Pagellus bogaraveo*) in Madeira (Portugal)

Year	Portugal	TOTAL
1988		0
1989		0
1990	6	6
1991	8	8
1992	7	7
1993	8	8
1994	7	7
1995	8	8
1996	4	4
1997	5	5
1998	14	14
1999	13	13
2000		
2001*		

*Preliminary

Table 14.1 continued

RED (=BLACKSPOT) SEABREAM (*Pagellus bogaraveo*) All ICES sea areas

Year	VI+VII	VIII	IX	X	XII	TOTAL
1988	252	137	689	637	0	1715
1989	189	272	676	924	0	2061
1990	134	312	594	889	0	1929
1991	123	134	532	874	0	1663
1992	40	124	797	1110	0	2071
1993	22	175	1000	829	0	2026
1994	10	131	1004	983	75	2203
1995	11	110	829	1096	0	2046
1996	29	23	978	1036	0	2066
1997	56	25	1011	1012	0	2104
1998	17	104	877	1114	0	2112
1999	25	104	543	1222	0	1884
2000	20	268	421	947	0	1655
2001*	50	170	275	1034	0	1629

* Preliminary

Table 14.2 *Pagellus bogaraveo* of Sub-area X (Azorean waters). Commercial input data to an illustrative XSA assessment

Table 14.2.a Catch numbers at age (Numbers*10⁻³)

AGE	YEARS														
	1986	1987	1988	1989	1990	1991	1992	1993	1994	1995	1996	1997	1998	1999	2000
1	114	15	135	280	53	17	41	15	2	0	0	6	96	86	7
2	151	150	501	694	310	303	264	166	69	47	11	89	315	153	101
3	262	252	431	398	492	592	607	448	300	450	284	406	718	386	212
4	345	295	341	461	410	363	445	408	313	481	528	321	325	249	244
5	244	173	143	305	184	177	266	199	118	282	222	166	122	153	150
6	164	151	125	183	131	131	163	133	133	142	164	112	97	140	144
7	83	70	48	55	76	73	85	57	95	99	105	78	67	76	59
8	82	75	35	56	83	83	104	85	126	111	137	96	86	92	68
9	22	22	14	17	41	34	37	31	58	52	59	40	36	44	35
+gp	24	25	13	26	52	45	74	42	112	85	53	137	160	228	151
TOTAL	1491	1228	1786	2475	1832	1818	2086	1584	1326	1749	1563	1451	2022	1607	1171

Table 14.2.b Weights (kg) at age

AGE	YEARS														
	1986	1987	1988	1989	1990	1991	1992	1993	1994	1995	1996	1997	1998	1999	2000
1	0.07	0.07	0.07	0.07	0.07	0.07	0.07	0.07	0.07	0.07	0.07	0.07	0.07	0.07	0.07
2	0.15	0.15	0.15	0.15	0.15	0.15	0.15	0.15	0.15	0.15	0.15	0.15	0.15	0.15	0.15
3	0.27	0.27	0.27	0.27	0.27	0.27	0.27	0.27	0.27	0.27	0.27	0.27	0.27	0.27	0.27
4	0.41	0.41	0.41	0.41	0.41	0.41	0.41	0.41	0.41	0.41	0.41	0.41	0.41	0.41	0.41
5	0.57	0.57	0.57	0.57	0.57	0.57	0.57	0.57	0.57	0.57	0.57	0.57	0.57	0.57	0.57
6	0.75	0.75	0.75	0.75	0.75	0.75	0.75	0.75	0.75	0.75	0.75	0.75	0.75	0.75	0.75
7	0.95	0.95	0.95	0.95	0.95	0.95	0.95	0.95	0.95	0.95	0.95	0.95	0.95	0.95	0.95
8	1.15	1.15	1.15	1.15	1.15	1.15	1.15	1.15	1.15	1.15	1.15	1.15	1.15	1.15	1.15
9	1.35	1.35	1.35	1.35	1.35	1.35	1.35	1.35	1.35	1.35	1.35	1.35	1.35	1.35	1.35
+gp	2.04	2.04	2.04	2.04	2.04	2.04	2.04	2.04	2.04	2.04	2.04	2.04	2.04	2.04	2.04

Table 14.2.c Maturity rates at age (Females as proportion of total population)

AGE	YEAR														
	1986	1987	1988	1989	1990	1991	1992	1993	1994	1995	1996	1997	1998	1999	2000
1	0	0	0	0	0	0	0	0	0	0	0	0	0	0	0
2	0	0	0	0	0	0	0	0	0	0	0	0	0	0	0
3	0	0	0	0	0	0	0	0	0	0	0	0	0	0	0
4	0.01	0.01	0.01	0.01	0.01	0.01	0.01	0.02	0.02	0.03	0.03	0.03	0.03	0.03	0.03
5	0.06	0.07	0.08	0.08	0.09	0.1	0.1	0.1	0.09	0.09	0.09	0.09	0.09	0.09	0.09
6	0.21	0.24	0.26	0.28	0.31	0.33	0.28	0.24	0.2	0.17	0.17	0.17	0.17	0.17	0.17
7	0.41	0.44	0.47	0.49	0.5	0.51	0.45	0.38	0.31	0.26	0.26	0.26	0.26	0.26	0.26
8	0.58	0.6	0.62	0.63	0.64	0.64	0.57	0.49	0.42	0.34	0.34	0.34	0.34	0.34	0.34
9	0.70	0.71	0.72	0.73	0.73	0.73	0.66	0.59	0.51	0.43	0.43	0.43	0.43	0.43	0.43
+gp	0.88	0.88	0.88	0.88	0.88	0.88	0.84	0.79	0.73	0.65	0.65	0.65	0.65	0.65	0.65

Table 14.3a Index of abundance for Pagellus from Azorean commercial longline CPUE (catch (kg) at age per 1000 hooks).

	YEARS														
Age (yr)	1986	1987	1988	1989	1990	1991	1992	1993	1994	1995	1996	1997	1998	1999	2000
1	3.00	0.41	3.65	5.49	0.88	0.26	0.58	0.20	0.03	0.00	0.00	0.10	1.81	1.13	0.10
2	3.97	4.05	13.54	13.61	5.17	4.59	3.72	2.24	1.06	0.97	0.16	1.51	5.93	2.01	1.46
3	6.89	6.81	11.65	7.80	8.20	8.97	8.55	6.05	4.62	9.28	4.19	6.89	13.52	5.06	3.05
4	9.08	7.97	9.22	9.04	6.83	5.50	6.27	5.51	4.82	9.92	7.80	5.45	6.12	3.26	3.52
5	6.42	4.68	3.86	5.98	3.07	2.68	3.75	2.69	1.82	5.81	3.28	2.82	2.30	2.01	2.16
6	4.32	4.08	3.38	3.59	2.18	1.98	2.30	1.80	2.05	2.93	2.42	1.90	1.83	1.83	2.07
7	2.18	1.89	1.30	1.08	1.27	1.11	1.20	0.77	1.46	2.04	1.55	1.32	1.26	1.00	0.85
8	2.16	2.03	0.95	1.10	1.38	1.26	1.46	1.15	1.94	2.29	2.02	1.63	1.62	1.21	0.98
9	0.58	0.59	0.38	0.33	0.68	0.52	0.52	0.42	0.89	1.07	0.87	0.68	0.68	0.58	0.50

Table 14.3b Index of abundance (relative population numbers) for Pagellus from Azorean longline survey.

	YEARS															
Age (yr)	1995	1996	1997	1998	1999	2000										
1	2.7	3.2	2		8.9	2										
2	11.8	2.8	5	No Surve y	5.9	8.5										
3	28.7	9.6	11.6		24	12.9										
4	25.4	7.6	10.6		10.7	8.5										
5	21.9	10.3	11.2		18.2	6.3										
6	10	3.4	5.4		10.9	2.9										
7	10.8	2.9	6.2		14.4	5.6										
8	3.1	0.8	3.1		10.5	3										
9	4.7	0.8	3.9		13.1	6.1										

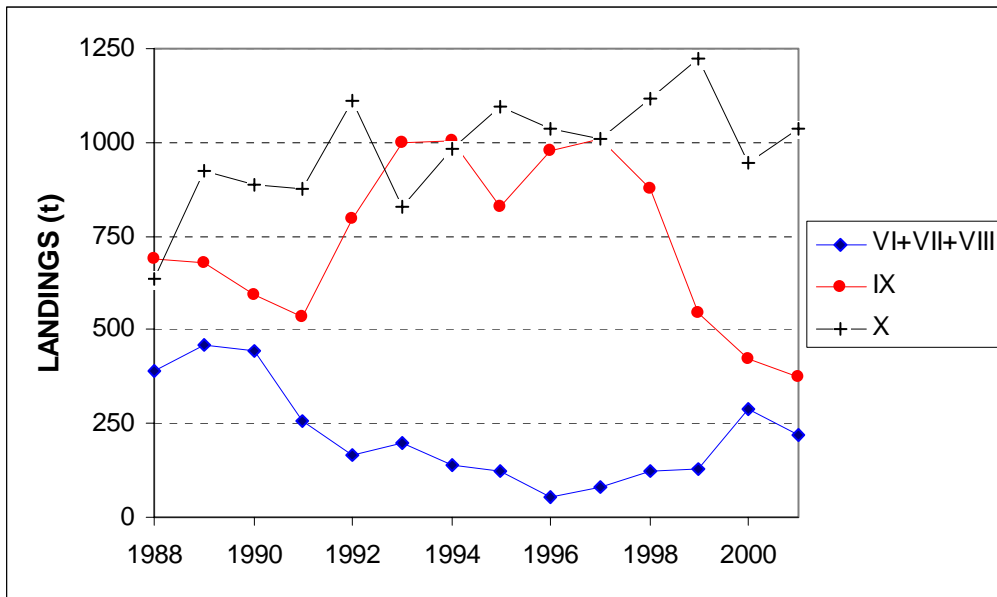

Figure 14.1 Evolution of the landings of *Pagellus bogaraveo* in the three sea areas considered (VI+VII+VIII, IX and X) in the period 1988-2001.

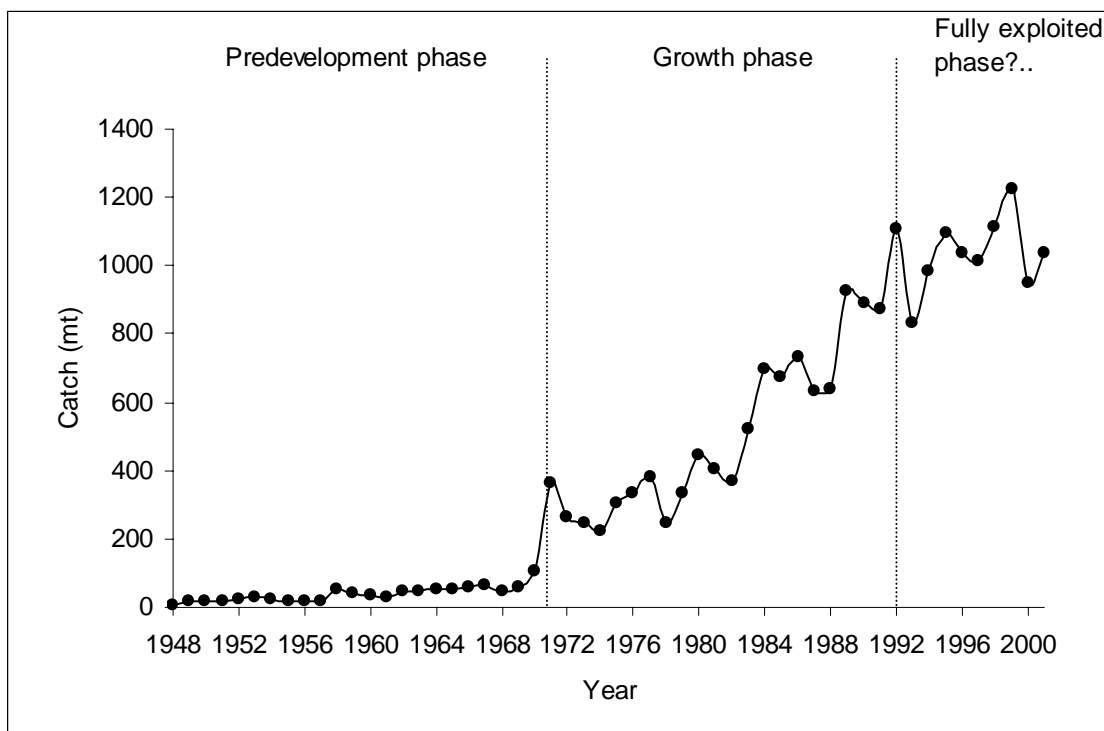

Figure 14.2 Historical catches of *Pagellus bogaraveo* in Azorean waters (ICES Sub-area X) in the period 1948-2001. (Vertical lines divided the three considered development phases of the Azorean fishery).

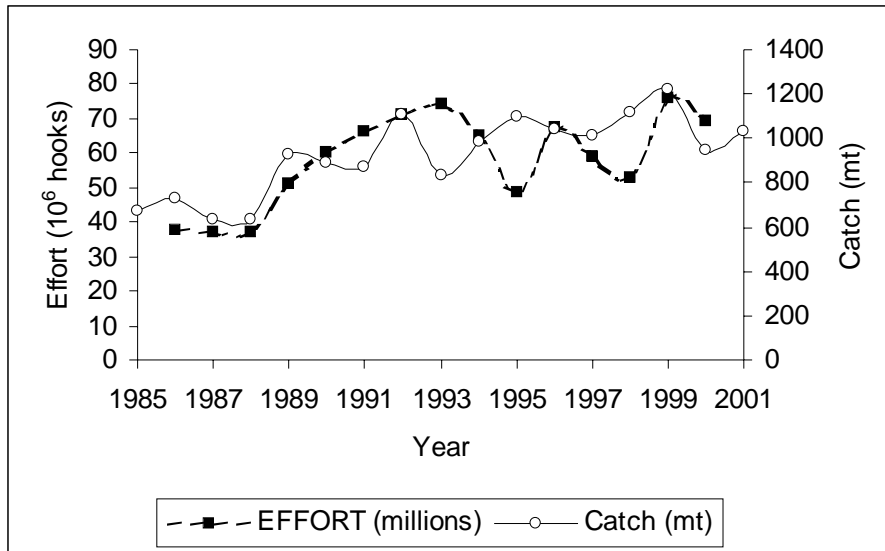

Figure 14.3 Catch (landings, in t) and effort (in 10⁶ hook) from the Azorean longline fishery on *Pagellus bogaraveo* in the period 1985-2001.

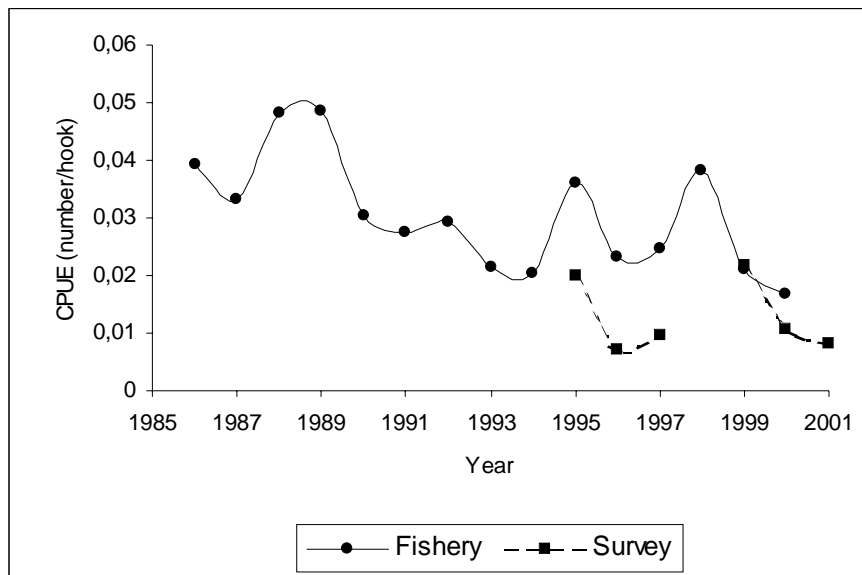

Figure 14.4 Commercial and survey CPUE (n°/hook) for *Pagellus bogaraveo* of the Azores, in the period 1985-2001.

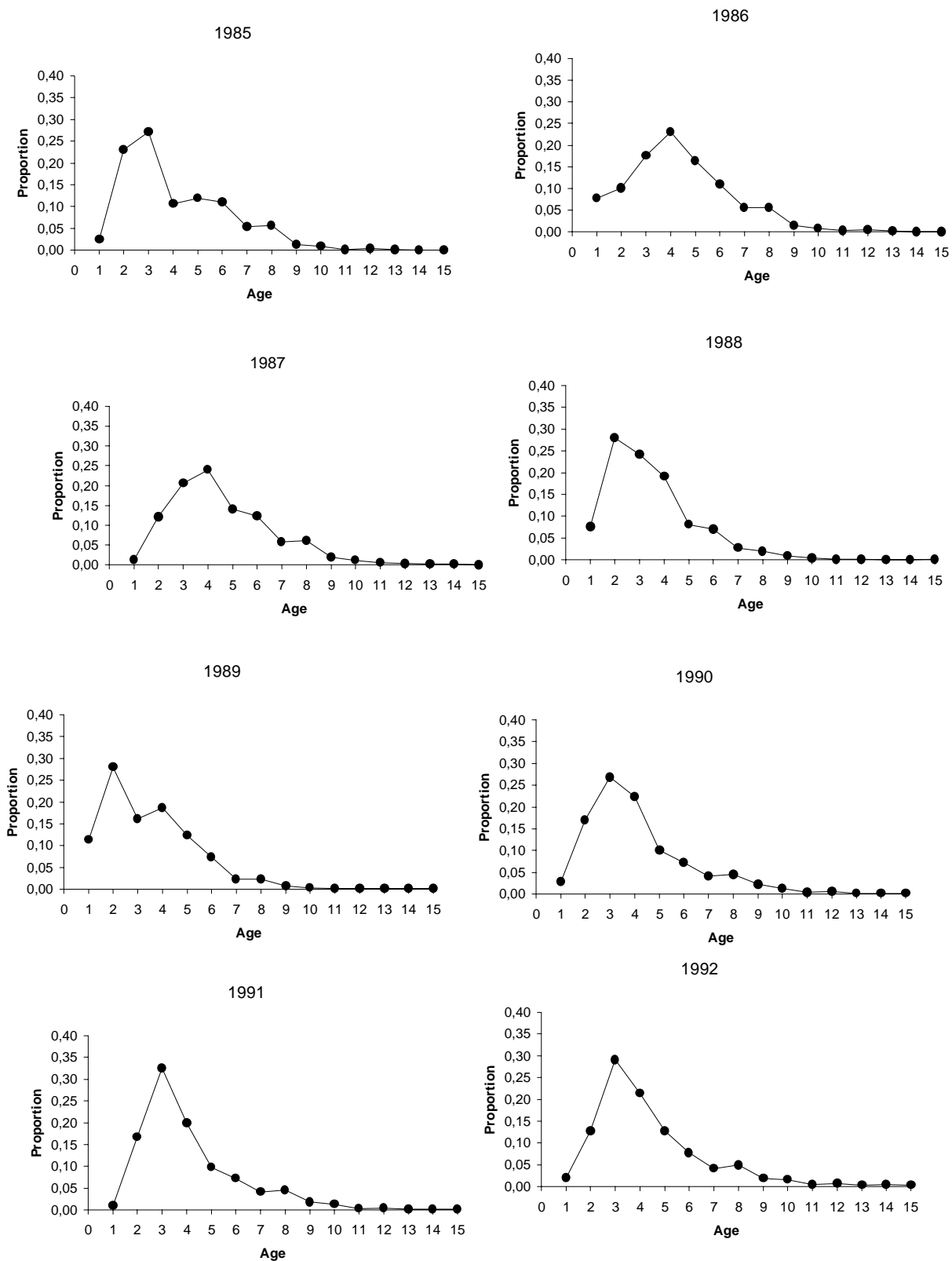

Figure 14.5 Age composition for *Pagellus bogaraveo* from Azorean commercial longline fishery in the period 1985-2001.

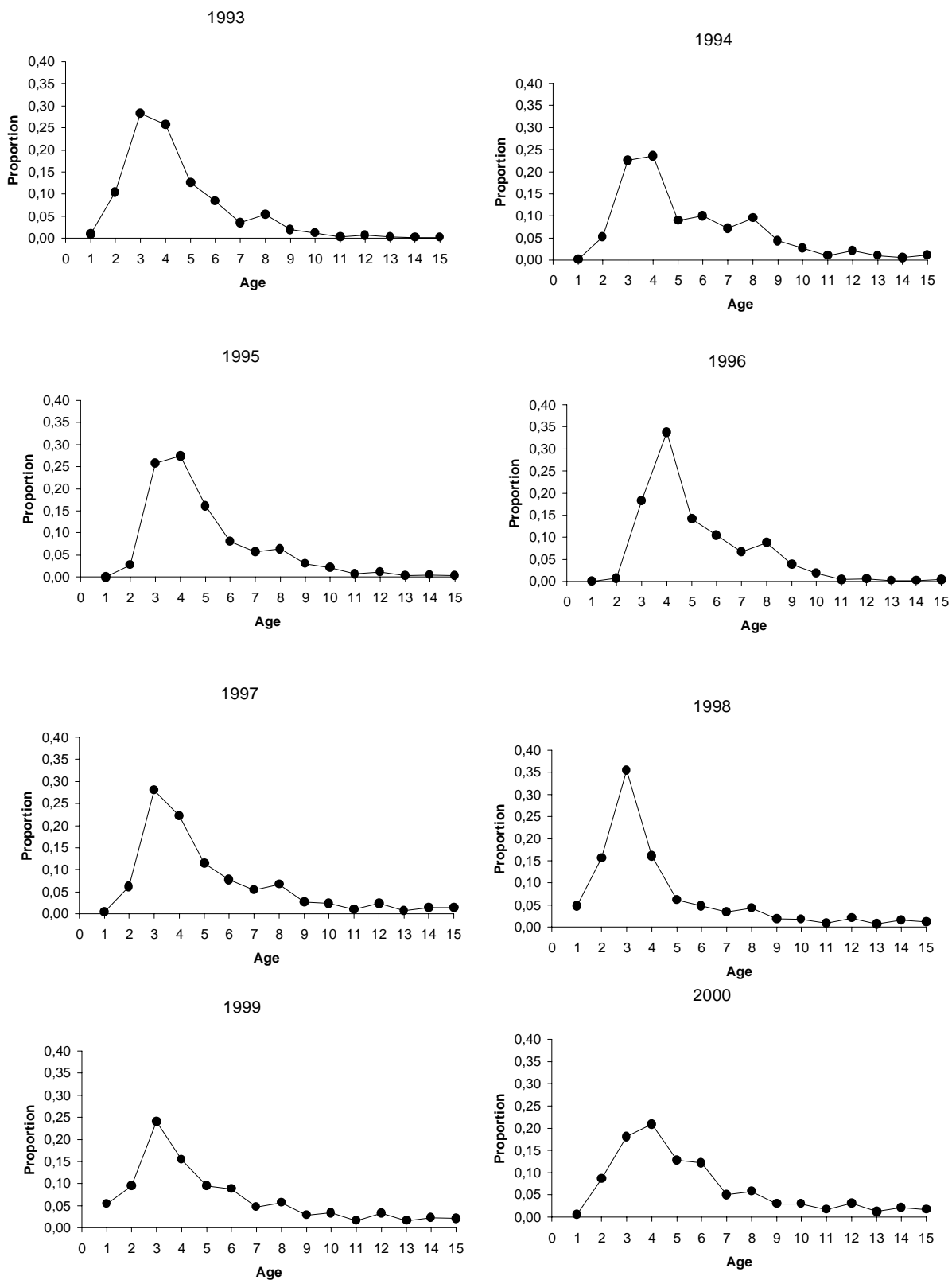

Figure 14.5 (Continued). Age composition for *Pagellus bogaraveo* from Azorean commercial longline fishery in the period 1985-2001.

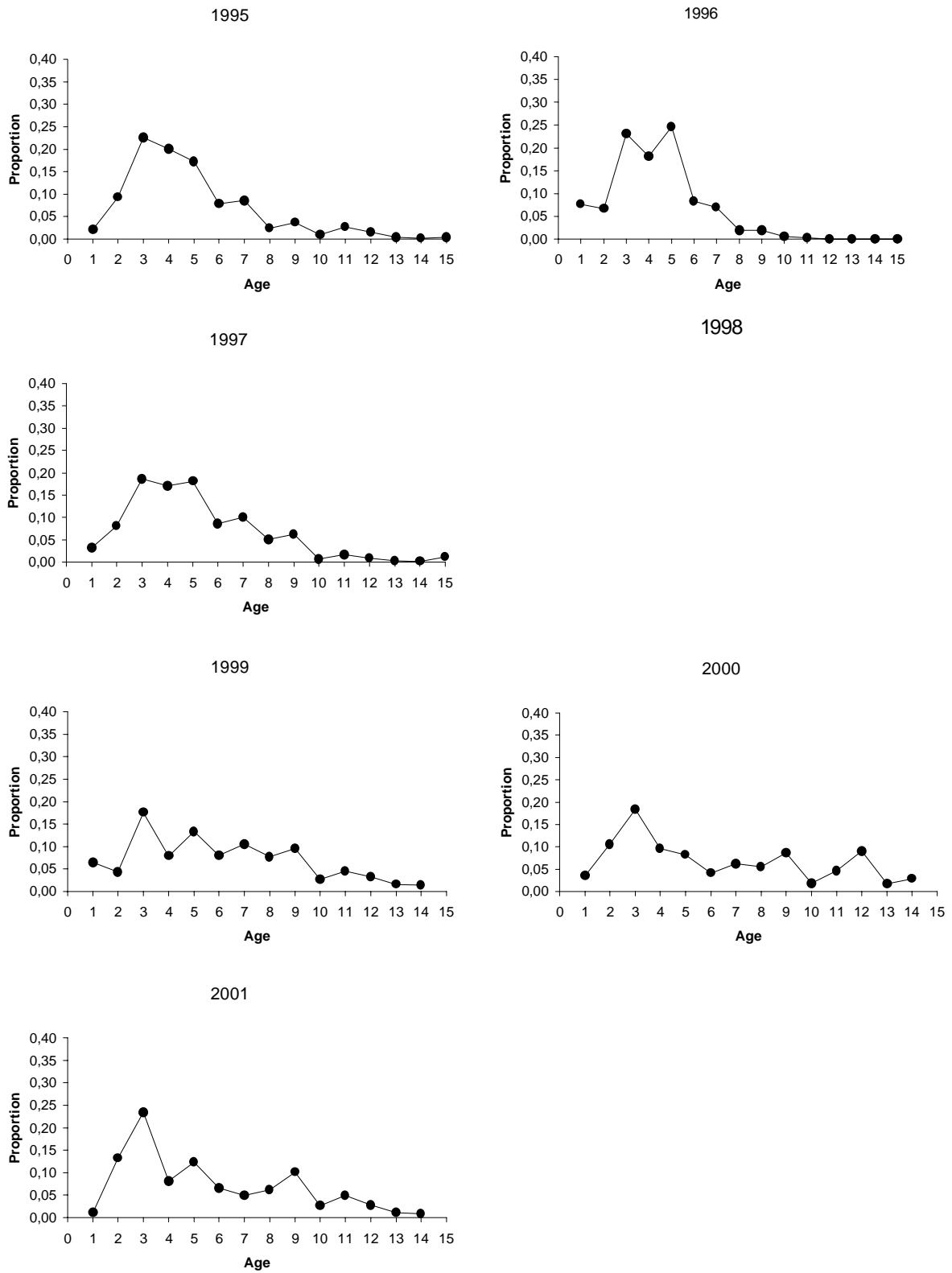

Figure 14.6 Age composition for *Pagellus bogaraveo* from longline survey in Azores in the period 1995-2001. (There are no data from 1998).

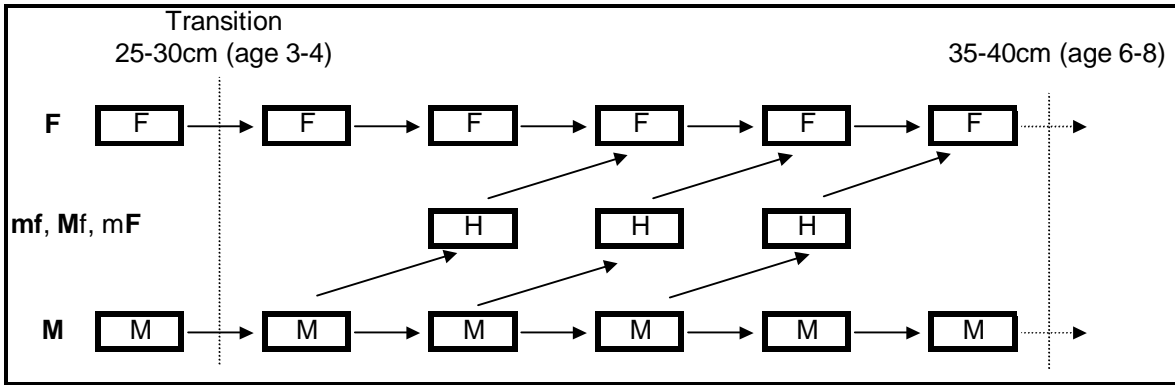

Figure 14.7 Schematic flow of sexual stages of *Pagellus bogaraveo*. F-females, M-males, H-hermaphrodites (mf-hermaphrodites, Mf-Hermaphrodites males, mF- hermaphrodites females). The size range of sexual change is indicated in the graph by dotted vertical lines.

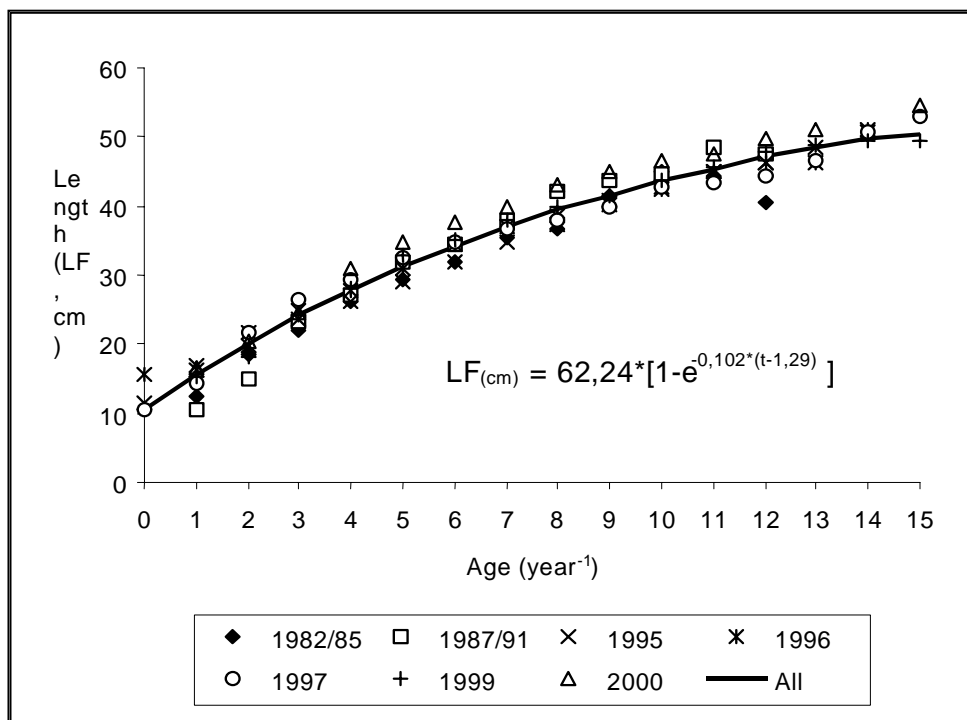

Figure 14.8 Estimated von Bertalanffy growth curve, for sex combined of *Pagellus bogaraveo* of Azores, from mean length at age pooled for all years.

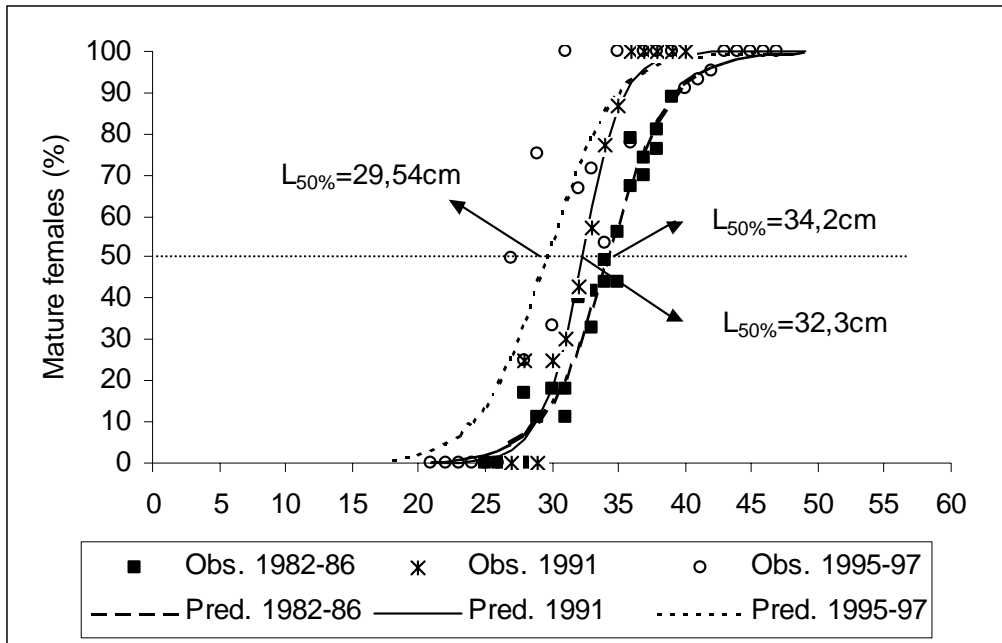

Figure 14.9 Maturity at length estimated for *Pagellus bogaraveo* of the Azores for the period 1982-1986, 1991 and 1995-1997. The lengths at which 50% of the females are mature are presented for each period.

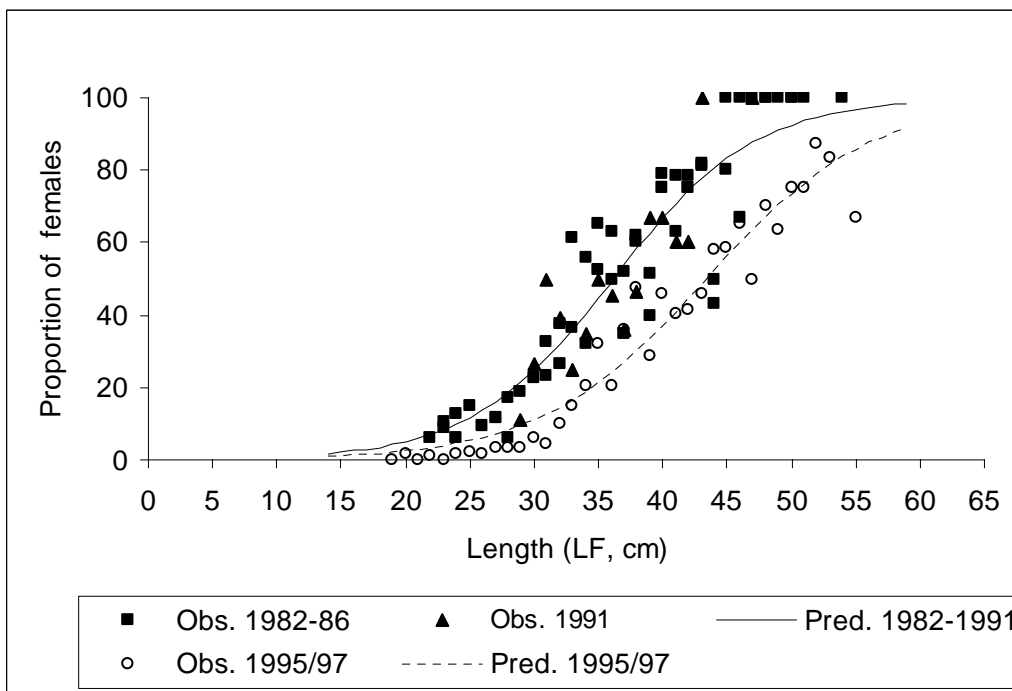

Figure 14.10 Observed females sex-ratio of *Pagellus bogaraveo* of Azores, for the periods 1982-1986, 1991 and 1995-1997 and fitted curves for the periods 1982-1991 and 1995-1997.

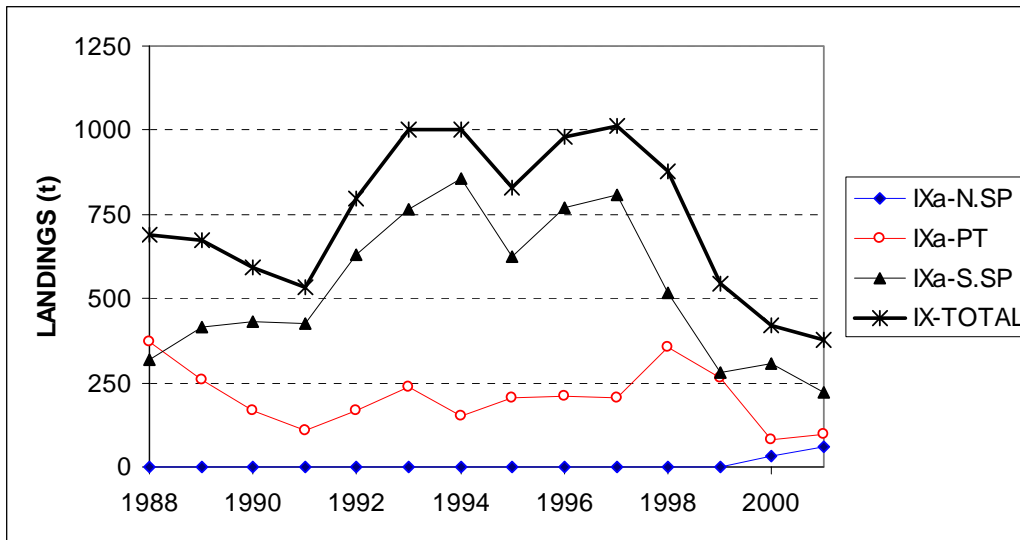

Figure 14.11 Evolution of the landings of *Pagellus bogaraveo* in the Sub-area IX in the period 1988-2001. Spanish landings in northern Div. IXa (IXa-N.SP) and in southern Div. IXa (IXa-S.SP), and Portuguese landings (IXa-PT) are represented separately.

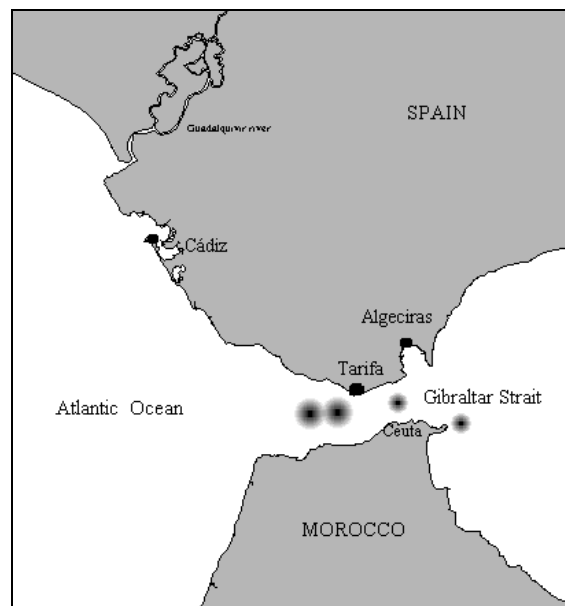

Figure 14.12 Main landing ports and fishing areas of the artisanal longline (“voracera”) fishery on *Pagellus bogaraveo*, in southern Div. IXa, Strait of Gibraltar (from Gil *et al.*, 2000).

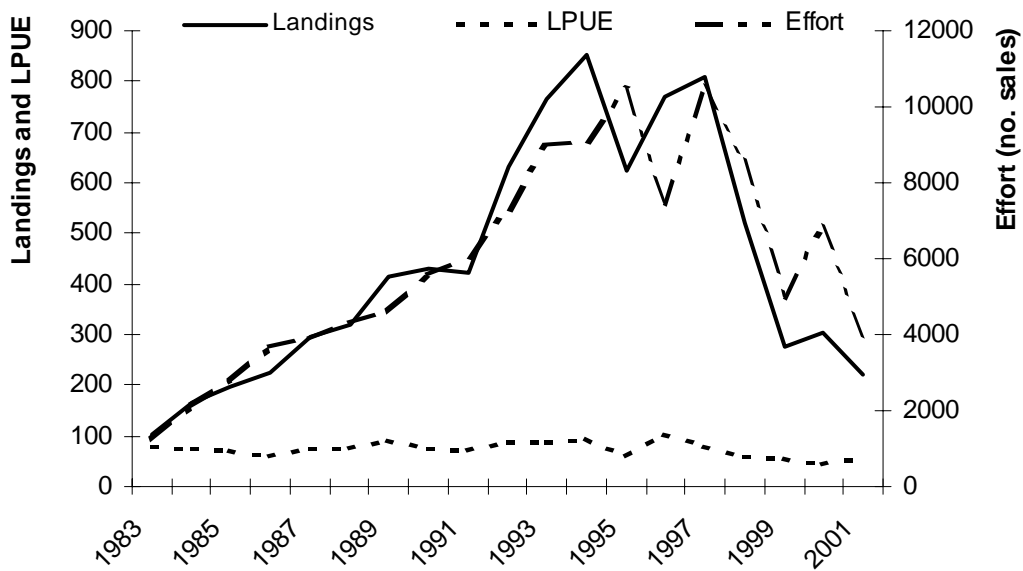

Figure 14.13 Evolution of landings, effort and LPUE of *Pagellus bogaraveo* in southern Div. IXa, Strait of Gibraltar, in the period 1983-2001.

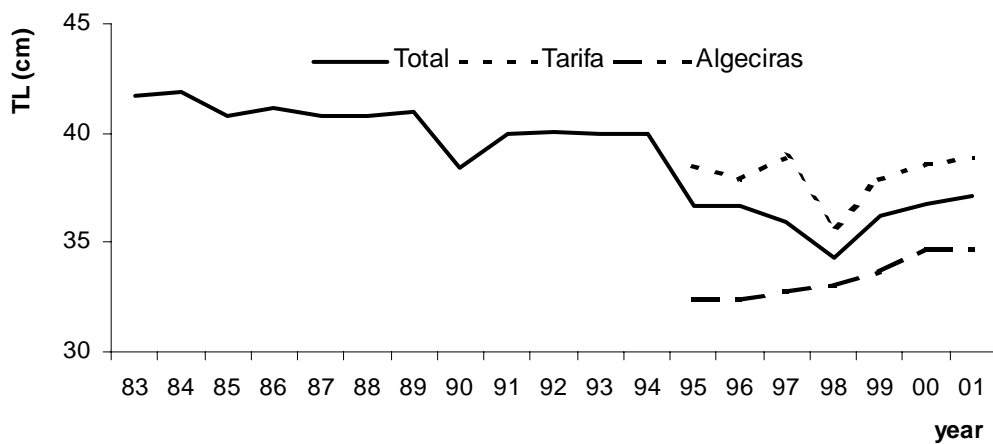

Figure 14.14 Landings mean total length (TL) evolution by port (1983-2001) of *Pagellus bogaraveo* in southern Div. IXa, Strait of Gibraltar, in the period 1983-2001.

15 GREATER FORKBEARD (*PHYCIS BLENNOIDES*)

15.1 Catch trends

Table 15.1 shows the landings of *Phycis blennoides* by ICES Sub-areas as reported to ICES or as provided by the Working Group. The 2001 data are provisional. Greater forkbeard may be considered as a bycatch species in the traditional demersal trawl and longline fisheries for different target species (hake, megrim, monkfish, ling, blue ling a.o.). The majority of landings came from the West of Scotland/Rockall Trough, West of Ireland/Western Approaches, Biscay and off the Portuguese Coast. Landings from some areas and countries also contain *Mora*. As in the previous reports of SGDEEP, the information is provided by four different components according to the importance of the catches and their geographical distribution.

- Greater forkbeard in Sub-areas I, II, III, IV and V.
- Greater forkbeard in Sub-areas VI, VII and XII (Hatton Bank).
- Greater forkbeard in Sub-areas VIII and IX.
- Greater forkbeard in Sub-area X (Azorean region).

In Sub-areas I, II, III and IV the small landings registered mainly by Norway have declined since 1993. In Sub-area V landings in 2001 increased to 98 tonnes. The Norwegian longliners which fish in these areas catch *P. blennoides* as a bycatch in the ling fishery. The quantity of this bycatch depends on market price. Preliminary data from 2001 shows an increase of the landings from all countries that provides information to this Working Group.

In Sub-areas VI and VII landings ranged between 2000 and 4500 tonnes from 1995 until 2001. The change in the landings probably represents a change in target species rather than variations in the abundance of *P. blennoides*. Scottish landings from 1999 to 2001 includes landings abroad and are thus higher than in previous years. From Sub-area XII Norwegian landings mainly come from a commercial longline fishery targeting Greenland Halibut at Hatton Bank established in 2000 and expanded in 2001 (Hareide *et al.*, WD). There are also small French and UK landings. Landings from these Sub-areas (VI, VII and XII), comprises around 85 % of the total landings of the species in ICES area.

In Sub-areas VIII and IX the bulk of the landings are Spanish and have increased from 81 tonnes in 1988 to 665 tonnes in 1998. This is probably because of the start of a directed longline deep water fishery from Asturias and Cantabria ports.

In the Sub-area X (Azorean region) landings by Portugal includes Moridae. Like in other areas this is not a target fishery and landings are variable.

15.2 Stock structure

The Greater forkbeard is a gadoid fish which is widely distributed in the North-Eastern Atlantic from Norway and Iceland to Cape Blanc in West Africa and the Mediterranean (Svetovidov, 1986; Cohen *et al.*, 1990). It is distributed along the continental shelf and slope in depths ranging between 60 and 800 m but recent observations on board commercial longliners and research surveys extend the depth range to beyond 1000 m (Stefanescu *et al.*, 1992). Unfortunately very little is known about stock structure of the species. The above separation does not pre-suppose the existence of four different stocks of *P. Blennoides* only offers a way of recording the available information.

15.3 Commercial CPUE and research surveys

In addition to what was presented in the SGDEEP 2000 report (ICES CM 2000/ACFM:8), new CPUE data was available from Irish long-line surveys in Sub-areas VI and VII (Clarke *et al.*, 2002). (See Section 18.1 for more details on the surveys.) Table 15.2 gives the CPUE data from Irish surveys.

Portuguese deep-water surveys carried out in Sub-area IXa showed that the species is evenly distributed over continental slope at depths ranging from 200 to 900 m with no apparent preference for a particular substrate type. Mean

yields of more than 10 Kg/h are usually obtained at depths greater than 600 m (Gordon, 1999). Data from September 2001 survey are not available yet.

Norway organized a feasibility fishery in 2001 with three longliners and one trawler on Hatton Bank (Kjerstad *et al.*, 2002). Feasibility longliners gives a total effort of 265600 hooks with a catch of 8026 kg of *P. blennoides* which is about 8 % of the total catch in depths between 500 and 1000 meters in ICES Sub-area VIb as reported to this WG by Hareide *et al.* (WD).

A Spanish research bottom trawl survey was carried out in Sub-area VII (Porcupine 0901) in 2001 (Velasco F., *pers. com.*) (See Section 18.1 for more details on the survey.). The greater forkbeard catch distribution is presented in Figure 15.1. The species was rather uniformly distributed in the area. The greatest catches were made deeper than 400 m in the NW area close to the Irish shelf.

A Russian longliner surveyed the SW and W slope of the Rockall Bank in December 2001. Greater forkbeard was the second most abundant species (23.1% of the total catch). It was found in catches from 300 to 1030 m. The largest number of settings were performed from 360 to 700 meters reaching a mean yield of 31.8 kg per 1000 hooks. *P. Blennoides* comprised up to 51% of this total catch (Vinnichenko *et al.*, WD).

Commercial CPUE data were available from the French trawler fleet in ICES Sub-areas VI, VII and VIII. Figure 15.2 shows the trends per ICES Sub-area in 1990-2001. Greater forkbeard is a minor bycatch species and the CPUE was therefore not used as an abundance index. In addition, Greater forkbeard is not always reported separately and may be mixed with morids. As a result, these CPUE estimates cannot be used as input data for the surplus production model assessment.

15.4 Length and age composition

Figure 15.3 shows the length frequency distribution from the Irish longline survey in Sub-area VII in 2000. Lengths ranged from 21 to 87 cm with two main modes at 44 and 50 cm (Clarke *et al.*, 2002).

Length frequency distribution from the 2001 Spanish bottom trawl survey on the Porcupine Bank (Sub-area VII) is given in Figure 15.4. The length range was 10-68 cm (Velasco F., *pers. com.*), and there were modes at 12-14 cm, and 28 and 30 cm.

Portuguese deep-water surveys carried out in Sub-area IXa showed that at depths greater than 600 m large individuals are more frequent. In the 1997/1998 surveys the mean total length was 38.6 and 28.9 cm for females and males respectively (Gordon, 1999). Data from September 2001 survey are not yet available.

Size distributions from Russian longline survey on the Rockall Bank comprised fish from 44 to 71 cm with a mean length of 55.8 cm. In a bottom trawl survey carried out in June and July 2001 at the Rockall bank and Hatton Bank caught single individuals of 32-64 cm length, in the depth range 515-1170 meters (Vinnichenko *et al.*, WD).

In Sub-area VI the first analysis from the sampling program carried out at Scottish ports indicated that the variations observed in quarterly length frequencies were probably a function of movements of fishing effort up or down the slopes as well as seasonal movements of fish stocks (Gordon, 1999). More recently there are indications that the trend in recent years has been towards fishing at greater depths and thus it would seem unlikely that the change in fishing depth has been the cause of the observed changes. It appears most likely that a change in market conditions has led to small fish, which would previously have been discarded, being retained and landed (Gordon, 1999).

15.5 Discards

The Norwegian discard sampling program mainly carried out in Sub-area IVa under the EC FAIR Deep-fisheries project indicated that all the greater forkbeard were discarded. The total length ranged from 32 to 64 cm (Gordon, 1999). However in the years 1990 to 1993 this species was landed as by-catch at Norwegian ports, the total landings amounted 440 t. This may have been due to a temporary increase in the price (Gordon, 1999).

In 1999 and 2000 a Spanish survey on quarterly basis was conducted by AZTI and IEO (EU DG XIV Study Contract N° 98/095). Observers onboard Spanish vessels studied the catch retentions and discards by different bottom trawl metiers in different ICES Sub-areas. Results for greater forkbeard are presented in Table 15. 3. Discard results must be considered with caution due because reasons for discarding vary. There is a great variability in the percentage retained and discarded for each metier, and even from each fishing trip. The values obtained in 2000 surely cannot be

extrapolated to other metiers of the same area and neither to the same metier in different years (Lucio *et al.*, WD; Pérez N., *pers. com.*).

15.6 Biological parameters

In the 2001 WGDEEP report (ICES CM 2001/ACFM:23) a first attempt was made to rank the deep-water species according to “vulnerability to fishing” as determined from available information on life history strategies. The following text table is a compilation of available data extracted and updated from the report of WGDEEP in 2001:

Variable	Value	Source/comment
Longevity (years)	15? 14 ♂ 7 ♀ 9	Gordon, 1999, Sub-t. 5.12, Doc.55 Casas & Piñeiro, 2000 Kelly, 1997
Growth rate, K	♂ 0.217 ♀ 0.087 ♂ 0.43 ♀ 0.39	Casas & Piñeiro, 2000 Kelly, 1997
Natural mortality, M	No data	
Fecundity (absolute)	No data	
Length at first maturity	♂ 31 cm ♀ 32 cm	Kelly, 1997
Age at first maturity	♂ 3 ♀ 2	ICES, 1998

Some new information was provided Vinnichenko *et al* (WD 2002). On a December 2001 Russian longline survey on the Rockall Bank 127 individuals of *P.blennoides* were examined and only one was male. The majority (65%) were immature females. All mature individuals were in postspawning condition.

15.7 Assessment

No assessment was attempted by the Working group due to the lack of suitable data.

15.8 Biological reference points

As no assessment was carried out by the Working Group, no biological reference points have been considered.

15.9 Comments on Assessment

No comments because no assessment.

15.10 Management considerations

No special management considerations can be suggested because there was no assessment, nor reliable data for CPUE trends. Gretare forkbeard is a bycatch and no existing CPUE-series are useful for the analyses. A single species management approach is unlikely to be effective. A clear distinction must be made between the species *Phycis blennoides* and *Phycis phycis* in future management proposals.

Table 15.1 Greater forkbeard (*Phycis blennoides*): Working Group estimates of landings (tonnes)**GREATER FORKBEARD (*Phycis blennoides*) I and II**

Year	Norway	France	Russia	TOTAL
1988	0			0
1989	0			0
1990	23			23
1991	39			39
1992	33			33
1993	1			1
1994	0			0
1995	0			0
1996	0			0
1997	0			0
1998	0			0
1999	0	0		0
2000	0	0		0
2001*	0	1	7	8

*Preliminary data

GREATER FORKBEARD (*Phycis blennoides*) III and IV

Year	France	Norway	E & W & N.I.	Scotland ⁽¹⁾	Germany	TOTAL
1988	12	0	3	0		15
1989	12	0	0	0		12
1990	18	92	5	0		115
1991	20	161	0	0		181
1992	13	130	0	2		145
1993	6	28	0	0		34
1994	11			1		12
1995	2			1		3
1996	2	10		6		18
1997	2			5		7
1998	1		0	11		12
1999	3		5	23		31
2000	3		0	7		11
2001*	5		1	19	2	26

*Preliminary data

(1) Includes Moridae

GREATER FORKBEARD (*Phycis blennoides*) Vb

Year	France	Norway	E & W & N.I.	Scotland ⁽¹⁾	TOTAL
1988	2	0			2
1989	1	0			1
1990	10	28			38
1991	9	44			53
1992	16	33			49
1993	5	22			27
1994	4				4
1995	9				9
1996	7				7
1997	7				7
1998	4	4			8
1999	6	28		0	34
2000	4	26	0	1	32
2001*	5	92		1	98

*Preliminary data

(1) Includes Moridae

Table 15.1 continued**GREATER FORKBEARD (*Phycis blennoides*) VI and VII**

Year	France	Ireland	Norway	Spain	E&W&N.I.	Scotland ⁽¹⁾	Germany	Russia	TOTAL
1988	252	0	0	1584	62	0			1898
1989	342	14	0	1446	13	0			1815
1990	454	0	88	1372	6	1			1921
1991	476	1	126	953	13	5			1574
1992	646	4	244	745	0	1			1640
1993	582	0	53	824	0	3			1462
1994	451	111		1002	0	7			1571
1995	430	163		722	808	15			2138
1996	519	154		1428	1434	55			3590
1997	512	131	5	46	1460	181			2335
1998	357	530	162	530	1364	97			3040
1999	317	686	183	796	929	518	1		3430
2000	622	743	380	1263	731	820	8	2	4568
2001*	587	663	536	1138	538	640	10	4	4116

*Preliminary data

(1) Includes Moridae

GREATER FORKBEARD (*Phycis blennoides*) VIII and IX

Year	France	Portugal	Spain	TOTAL
1988	7	0	74	81
1989	7	0	138	145
1990	16	0	218	234
1991	18	4	108	130
1992	9	8	162	179
1993	0	8	387	395
1994		0	320	320
1995	54	0	330	384
1996	25	2	429	456
1997	4	1	356	361
1998	3	6	656	665
1999	6	10	361	377
2000	31	6	346	383
2001*	22	8	421	451

*Preliminary data

GREATER FORKBEARD (*Phycis blennoides*) X

Year	Portugal ⁽¹⁾	TOTAL
1988	29	29
1989	42	42
1990	50	50
1991	68	68
1992	81	81
1993	115	115
1994	135	135
1995	71	71
1996	45	45
1997	30	30
1998	38	38
1999	41	41
2000	94	94
2001*	83	83

*Preliminary data

(1) Includes Moridae

Table 15.1 continued

GREATER FORKBEARD (*Phycis blennoides*) XII

Year	France	Norway	E&W&N.I.	Scotland ⁽¹⁾	TOTAL
1988					
1989					
1990					
1991					
1992	1				1
1993	1				1
1994	3				3
1995	4				4
1996	2				2
1997	2				2
1998	1				1
1999	0			0	0
2000	2			4	6
2001*	0	6	1	1	8

*Preliminary data

(1) Includes Moridae

GREATER FORKBEARD (*Phycis blennoides*) all ICES Sub-areas

Year	I+II	III+IV	Vb	VI+VII	VIII+IX	X	XII	TOTAL
1988	0	15	2	1898	81	29	0	2025
1989	0	12	1	1815	145	42	0	2015
1990	23	115	38	1921	234	50	0	2381
1991	39	181	53	1574	130	68	0	2045
1992	33	145	49	1640	179	81	1	2128
1993	1	34	27	1462	395	115	1	2035
1994	0	12	4	1571	320	135	3	2045
1995	0	3	9	2138	384	71	4	2609
1996	0	18	7	3590	456	45	2	4118
1997	0	7	7	2335	361	30	2	2742
1998	0	12	8	3040	665	38	1	3764
1999	0	31	34	3430	377	41	0	3913
2000	0	11	32	4568	383	94	6	5092
2001*	8	26	98	4116	451	83	8	4790

*Preliminary data

Table 15.2 Irish Research Surveys (1993-2000): *P. Blennoides* CPUE Data in ICES Sub-areas VI and VII.

Gear Type	Year	Effort	Weight (kg)	CPUE	Depth range (m)
Trawl	1993	11601 ⁽¹⁾	3350.74	17.33 ⁽¹⁾	201-1043
Trawl	1994	973 ⁽¹⁾	126.34	7.79 ⁽¹⁾	740-1230
Longline	1995	25563 ⁽²⁾	372.32	14.56 ⁽²⁾	
Trawl	1996	1225 ⁽¹⁾	73.3	3.59 ⁽¹⁾	760-1007
Trawl	1997	2345 ⁽¹⁾	145.93	3.73 ⁽¹⁾	615-1150
Longline	1998	26120 ⁽²⁾	457.12	17.50 ⁽²⁾	353-1178
Longline	1999	124620 ⁽²⁾	692.5	5.59 ⁽²⁾	468-1124
Longline	2000	44936 ⁽²⁾	874.02	19.45 ⁽²⁾	308-1010

⁽¹⁾ Effort (mins) and CPUE (k/hour)

⁽²⁾ Effort (hooks) and CPUE (k/1000 hooks)

Table 15.3 Spanish fleet (AZTI and IEO data): Greater forkbeard retained and discarded catches by metier and ICES Sub-areas in 1999-2000.

1.- AZTI data (Lucio *et al.*, WD)

Metier 1: Bottom Otter "Baka" trawl in Div. VIIIh-j :: Mixed fishery :: Mesh size = 80 mm :: Year 2000 :: Annual values

Deeptype species captured	N° Discarded	CVDisc.	N° Retained	CVRetain	N° Total Catch	% Discarded	WeightDiscarded	Weigh Retained
Greater forkbeard (<i>Phycis blennoides</i>)	228254	416	376760	351	605013	38	17897	52732

Metier 3: Bottom Pair trawl with VHVO nets in Div. VIIIa,b,d :: Targeted fishery :: Mesh size = 75 mm :: Year 2000 :: Annual values

Deeptype species captured	N° Discarded	CVDisc.	N° Retained	CVRetain	N° Total Catch	% Discarded	WeightDiscarded	Weigh Retained
Greater Fork Beard (<i>Phycis blennoides</i>)	n.e.b.n.				n.e.b.n.	100	2793	

2.- IEO data (Nélida Pérez, *pers. com.*)

Spanish Baka Otter Trawl fishery targeting in hake, witch, Norway lobster and megrim. Sub-areas VI-VII. Second semester of 1999.

Species	N° Discarded	CVDisc.	N° Retained	CVRetain	N° Total Catch	% Discarded	WeightDiscarded	Weigh Retained
Greater forkbeard (<i>Phycis blennoides</i>)	425	177	416	87	841	51	79710	186587

Spanish Baka Otter Trawl fishery targeting in hake, witch, Norway lobster and megrim. Sub-areas VI-VII. Year 2000.

Species	N° Discarded	CVDisc.	N° Retained	CVRetain	N° Total Catch	% Discarded	WeightDiscarded	Weigh Retained
Greater forkbeard (<i>Phycis blennoides</i>)	1053	162	527	101	1580	67	175822	264666

Spanish Baka Otter Trawl mixed fishery in Division VIIIc Central. Second semester of 1999.

Species	N° Discarded	CVDisc.	N° Retained	CVRetain	N° Total Catch	% Discarded	WeightDiscarded	Weigh Retained
Great fork beard (<i>Phycis blennoides</i>)	0		1	226	1	0.0	0	306

Spanish Baka Otter Trawl mixed fishery in Division VIIIc Central. Year 2000.

Species	N° Discarded	CVDisc.	N° Retained	CVRetain	N° Total Catch	% Discarded	WeightDiscarded	Weigh Retained
Great forkbeard (<i>Phycis blennoides</i>)	6	600	4	290	9	60	323	457

Spanish Baka Otter Trawl mixed fishery in Divisions VIIIc West and IXa. Second semester of 1999.

Species	N° Discarded	CVDisc.	N° Retained	CVRetain	N° Total Catch	% Discarded	WeightDiscarded	Weigh Retained
Great forkbeard (<i>Phycis blennoides</i>)	266	408	84	292	350	76	10151	16594

Spanish Baka Otter Trawl mixed fishery in Division VIIIc West and IXa. Year 2000.

Species	N° Discarded	CVDisc.	N° Retained	CVRetain	N° Total Catch	% Discarded	WeightDiscarded	Weigh Retained
Great forkbeard (<i>Phycis blennoides</i>)	805		263		1068	75	49000	71033

Spanish Pair Trawl targeting blue whiting Divisions VIIIc, IXa. Second semester 1999.

Species	N° Discarded	CVDisc.	N° Retained	CVRetain	N° Total Catch	% Discarded	WeightDiscarded	Weigh Retained
Great forkbeard (<i>Phycis blennoides</i>)	0		1	226	1	0.0	0	306

Spanish Pair Trawl targeting blue whiting Divisions VIIIc, IXa. Year 2000.

Species	N° Discarded	CVDisc.	N° Retained	CVRetain	N° Total Catch	% Discarded	WeightDiscarded	Weigh Retained
Great forkbeard (<i>Phycis blennoides</i>)	6	600	4	290	9	60	323	457

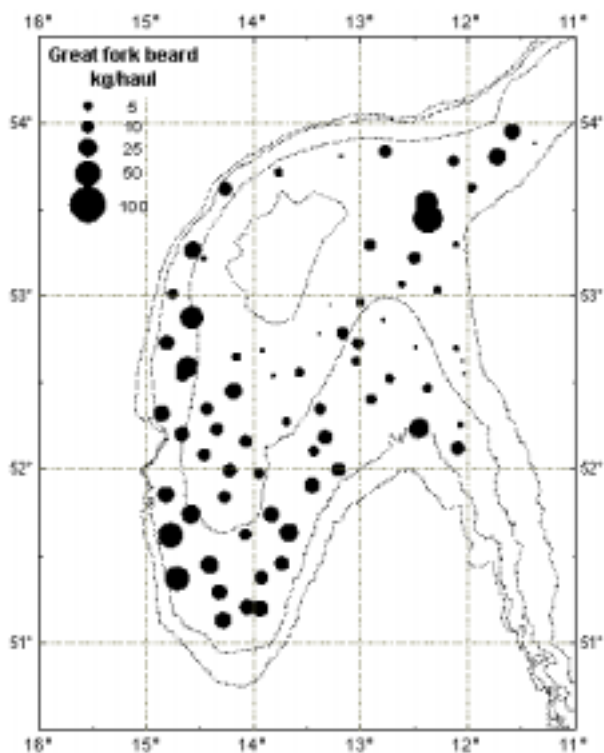

Figure 15.1 Spanish Bottom Trawl Survey Porcupine 0901: Abundance distribution of *Phycis blennoides*.

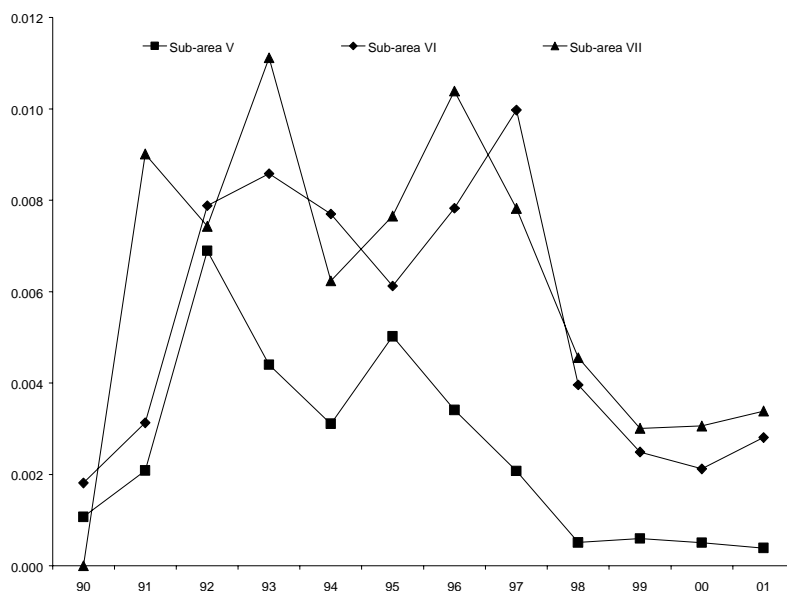

Figure 15.2 French trawler fleet CPUE for *Phycis blennoides* (1990-2001).

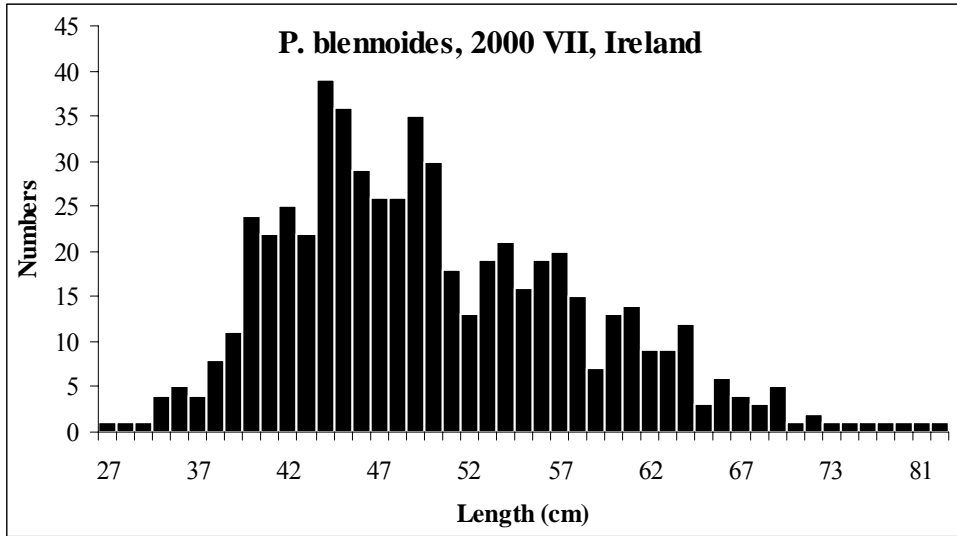

Figure 15.3 Length frequency distribution for *P. bleunoides* from Irish longline survey of Sub-area VII in 2000.

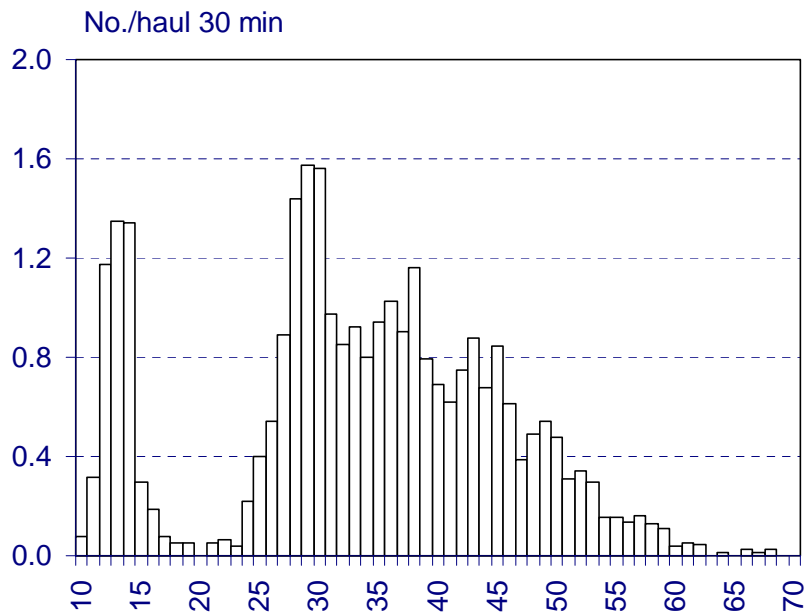

Figure 15.4 Length frequency distribution for *P. bleunoides* from Spanish bottom trawl survey in Sub-area VII in 2001.

16 ALFONSINOS/GOLDEN EYE PERCH (*BERYX SPP*)

16.1 Catch trends

Table 16.1 shows the landings data for Alfonsinos, (*Beryx spp*), by ICES Sub-areas/Divisions as officially reported to ICES or to the Working Group. No data on discards have been presented. In most cases the statistics refer to both species combined (*Beryx splendens* and *Beryx decadactylus*). In general, it is not known if the annual variations in landings are due to changes in fish abundance, changes in the targeting of the fisheries or to more accurate reporting or monitoring of the landings. Alfonsinos are usually a bycatch of demersal fisheries targeting other species.

Landings reported from Sub-areas IV-V are very small and most were taken by French vessels.

In Sub-areas VI-VII, landings were very small and variable until 1995, ranging from 12 t (in 1989) to 1 t (in 1993). In 1996, however, landings increased to 178 t, taken as by-catch of the Spanish demersal, mainly long-line fisheries in Sub-area VII. In 1998 and 1999 landings amounted to about 80 t and were reported by France and Spain. Between 2000 and 2001 landings amounted to about 100 t and were reported only by Spain.

In Sub-areas VIII-IX, the reported landings were very small (1-2 t) and scattered until 1994, but they have increased continuously from 1995 onwards. In 1998 they amounted to 269 t. In the period 1999-2001 the reported landings varied between 160 t and 224 t, mainly due to the Spanish landings. Most of these landings can be regarded as bycatches of the Spanish and Portuguese demersal (longline) fisheries in these Sub-areas.

Overall, most of the alfonsino landings are taken in Sub-area X. They are mainly from long-liners fishing within the Azorean EEZ and by trawlers fishing north of that area. Landings from the Azores increased steadily from 185 t in 1987 to 635 t in 1994 and then decreased (to 175 t in 1999). The landings series in the period 1987-2001 for both species separately is presented in the text table below and in Figure 16.3 & 16.4 (G. Menezes and M. Pinho, pers. com.).

Landings (tonnes) of *Beryx spp.* in Azorean waters:

	<i>B. splendens</i>	<i>B. decadactylus</i>	<i>Beryx spp Total</i>
1987	108	77	185
1988	122	103	225
1989	113	147	260
1990	137	201	338
1991	203	168	371
1992	274	176	450
1993	317	217	534
1994	404	231	635
1995	331	192	523
1996	366	171	537
1997	268	111	379
1998	160	68	228
1999	119	56	175
2000	172	37	209
2001	182	17	199

Landings of *Beryx spp.* by former USSR trawlers were estimated to be around 1800 t during 1978–1979. Landings by Russian trawlers in the North Azores area were also estimated for some years in the 1990s. They oscillated between 100 and 864 t. In 1998-1999 and 2001 no landings were reported by Russia for the Sub-area X. In 2000 one trawler worked a few days in the area catching 5 t.

Finally, in Sub-area XII, landings (2 t) were reported only in 1995, by the Faroe Islands. In the period 1996-2001 no landings data were reported for this area.

16.2 Stocks

The EU has been funding the study “Seasonal changes in biological and ecological traits of demersal and deep-water fish species in the Azores” (DG XIV/C/1- Study contract 97-081) (Menezes *et al.* 2001). The aim of this study was to obtain an objective picture of the stock structure of one or more of the most important commercial species inhabiting the area for management purposes (for a detailed description of the methods used see Menezes *et al.* 2001).

The results for *Beryx splendens* are preliminary, but they suggest that significant genetic differentiation may occur between populations of *Beryx splendens* within the North Atlantic. This may have some implications for the management of the fisheries. Further investigations of the stock structure of *Beryx splendens* should be given priority to elucidate the stock structure of this species (Menezes *et al.* 2001).

16.3 Commercial CPUE and Research Surveys

No data are available on commercial CPUEs.

Information on length frequency distributions as well as relative abundance for *Beryx* spp. by stratum (geographical area and depth) are available for 1995, but only for Azorean waters. These data were presented to the 1996 Study Group (ICES C.M.1996/Assess:8). The information on the Relative Abundance Index (RPN) for *Beryx splendens* and for *Beryx decadactylus* from longline surveys has been updated in 1999 (ICES C.M.2000/ACFM:8) and in 2001, but are considered too uncertain to use as indicators (Menezes *et al.* 1999). In the developing phase of the longline fisheries in Azorean waters (period: 1985-1993) there was an increasing trend in the landings of *Beryx* spp. However, after 1995/1996 a decreasing trend in of both species is seen, except in the last two years (2000 & 2001) where the landings of *B. splendens* increased slightly.

There are some evidence to suggest that the Azores region is close to the northern limit of distribution of the *Beryx* spp. in the Mid-Atlantic Ridge. According to Hareide (2002) *Beryx splendens* is distributed from 51°N and southwards. The available information on the reproduction (see below) does not indicate any presence of a spawning population in Azorean waters (Isidro, 1996; Menezes *et al.* 2001). This supports the hypotheses of a marginal distribution of the *Beryx* population in this region, and a natural low population abundance level.

16.4 Length and Age compositions

No new data were available to the WG for Sub-area X. In the 1996 Study Group Report length and age compositions of the catches in this area were presented for the period 1983–1993 (ICES C.M.1996/Assess:8).

From the other Sub-areas no data on length and age compositions in all the time series have been available to the Working Group.

16.5 Biological parameters

Information on the length-weight relationship, spawning season, depth distribution and other biological characteristics for both *Beryx* species from Sub-area X (Azorean region and the Mid-Atlantic Ridge) were reported in 1996 (ICES C.M.1996/Assess:8), 1998 (ICES C.M.1998/ACFM:12), 2000 (ICES C.M.2000/ACFM:8) and in 2001 (ICES C.M.2001/ACFM:23).

New data on the reproduction and growth of both *Beryx splendens* and *Beryx decadactylus* for the Azores were analysed in the project “Seasonal changes in biological and ecological traits of demersal and deep-water fish species in the Azores” (DG XIV/C/1- Study contract 97-081) (Menezes *et al.* 2001). Part of the results were already presented in the (ICES C.M.2001/ACFM:23).

Updated information on length-weight relationship is presented in Figures 16.1 and 16.2 for both *Beryx* species (from Menezes *et al.* 2001).

Current estimates of the biological variables of *Beryx splendens* and *Beryx decadactylus* are summarised in the text table below:

Beryx splendens

Variable	Value	Source/comment
Longevity (years)	11	Azores, Krug <i>et al.</i> , 1998
Growth rate, K ♂ ♀	0.134 0.141	Azores, (Menezes, <i>et al.</i> , 2001)
Natural mortality, M		No exact data available.
Fecundity (absolute)	millions	No exact data available.
Length at first maturity ♂ ♀	22.9 23	Azores, Mendonca <i>et al.</i> , 1998
Age at first maturity ♂ ♀	2 2	Azores, Mendonca <i>et al.</i> , 1998

Beryx decadactylus

Variable	Value	Source/comment
Longevity (years)	13	Azores, Krug <i>et al.</i> , 1998
Growth rate, K ♂ ♀	0.11 0.165	Azores, (Menezes, <i>et al.</i> , 2001)
Natural mortality, M		No exact data available.
Fecundity (absolute)	millions	No exact data available.
Length at first maturity ♂ ♀	30.3 32.5	Azores, Mendonca <i>et al.</i> , 1998
Age at first maturity ♂ ♀	4 4	Azores, Mendonca <i>et al.</i> , 1998

16.5.1 Age and growth

For the Azores area, two age-length keys and the parameters of the von Bertalanffy growth equations for both the *Beryx* species are given in Tables 16.2, 16.3, 16.4 and 16.5 (for details see Menezes *et al.* 2001). Age determination was carried out by means of the *sagittae* otoliths.

Beryx decadactylus

The results obtained for the age and growth for *B. decadactylus* of Azores compared with those from Canary ($L_{\infty}=58.11$ cm FL, $K=0.11$ year⁻¹, $t_0=-4.70$ year) and Madeira ($L_{\infty}=70.10$ cm FL, $K=0.07$ year⁻¹, $t_0=-4.83$ year) Islands (Krug *et al. submitted*) are in a good agreement. Similar age ranges are observed in all archipelagos: fish aged 0 to 9 years (21.0-44.0 cm FL) were found in the Canary Islands, 1 to 11 years (20.0-45.0 cm FL) in Madeira, and 2 to 9 years (20.0-49.0 cm FL) in the Azores. The length ranges were also similar. The apparent differences in the von Bertalanffy growth parameters between the Azores and Madeira are not statistically significant (Menezes *et al.* 2001). Isidro (1996) gave for this species from the Azores an asymptotic size ($L_{\infty}= 56.3$ cm) slightly lower than Menezes *et al.* (2001) and a

similar value of coefficient k (0.107 year^{-1}). As a whole, growth of *B. decadactylus* from the Macaronesian archipelagos is relatively slow, with males and females growing at the same rate (Menezes *et al.* 2001).

Beryx splendens

All growth studies using otoliths of the alfonsino indicate the presence of visible growth marks, however, annuli interpretation vary greatly according to the investigator (Lehodey and Grandperrin, 1996). In the Macaronesian archipelagos it was assumed that a translucent ring and its adjacent opaque ring are laid down each year on the otoliths (Menezes *et al.* 2001). In the study of Rico *et al.* (2001) the growth parameters between Azores and Canaries are very similar, the significant differences (covariance analysis) found between growth parameters of Madeira and each one of the other two archipelagos ($L_{\infty}=44.51 \text{ cm FL}$, $K=0.15 \text{ years}^{-1}$, and $t_0=-3.41 \text{ years}$ in the Canary Islands; $L_{\infty}=58.71 \text{ cm FL}$, $K=0.06 \text{ years}^{-1}$, and $t_0=-5.71 \text{ years}$ in Madeira) could be partially explained by the different interpretation of the otoliths by different readers (Menezes *et al.* 2001).

The alfonsino has a relatively long lifespan in the Macaronesian archipelagos (Rico *et al.* 2001), the oldest fish examined in the Canary Islands was 9 years old (38 cm), in Madeira 12 years old (41 cm), and in the Azores 11 years old (40 cm), but 7 years in the study of Menezes *et al.* (2001). Similarly, in New-Year Rise and Angular Rise this species may attain an age of 9 and 11 years (41 and 48 cm FL) respectively (De León and Malkov, 1979). Massey and Horn (1990) and Lehodey and Grandperrin (1996) recorded fish up to 16 and 15 years old (57 and 52 cm FL) in New Zealand and New Caledonia, respectively. Kotlyar (1987) found that this species might attain an age of 5, 6 and 8 years (28, 34 and 41 cm) in Kit Range, Naska Range and Error Seamount, respectively. Differences in growth between areas seem to be related to the oceanographic conditions rather than to the methodology employed (Menezes *et al.* 2001).

16.5.2 Reproduction

Beryx decadactylus

In *Beryx decadactylus* the female GSI is of low amplitude and does not suggest any particular restricted period of spawning activity. In males the GSI evolution shows some tendency for a maximum between May and July and a minimum between August and December (Isidro, 1996).

In a recent study (Menezes *et al.* 2001), despite the reduced amount of information available, the GSIs of males showed some tendency for a maximum between spring and late summer. Females GSIs were of low amplitude and did not suggest any period of spawning activity. Isidro (1996) obtained similar results for females in the analysis of all months. The macroscopic and microscopic observations did not provide a description of a consistent reproductive cycle for males. Isidro (1996) concluded that the microscopic observation of histological section of male testes did not provide a description of a consistent annual population spermatogenesis cycle. He also noted a great intra-month and inter-individual variability in the spermatogenesis activity and on the amount of sperm stored. For females, the macroscopic identifications appear to compare well with the histological observations. The microscopic observation of histological section of ovaries did not reveal any females in spawning activity for the months analysed. Isidro (1996) recorded for Azores females in spawning stages. However he suggested a pattern of episodic spawning made by a few individuals several times throughout the year. He also observed a relevant absence of gonads with oocytes undergoing vitellogenesis. No relevant differences were noted in the seasonal frequency between island and bank areas in the Azores (Menezes *et al.* 2001). The reproductive behaviour of this species needs to be studied in more detail.

Beryx splendens

In *Beryx splendens* the gonadosomatic index for females revealed a fluctuation of low amplitude attaining a maximum value in May. For males the same happened but the maximum GSI value occurred in June (Menezes *et al.* 2001). This period is in advanced in relation to the results achieved by Isidro (1996). The hepatosomatic indexes did not reveal any defined seasonal pattern (Menezes *et al.* 2001). The macroscopic and microscopic observations did not provide a description of a consistent reproductive cycle for females and males. For females only ovaries in stages 0, I and II were observed, meaning that no spawning fish was recorded. These results are in agreement with Horn *et al.* (1989) for New Zealand. Isidro (1996) also noted that no clear single annual population level-spawning season was really evident for females of this species, however he recorded a few spawning females in the Azores. For males, Isidro (1996) also concluded that the microscopic observation of histological section of testes did not provide a description of a consistent annual population spermatogenic cycle. He also noted a great intra-month and inter-individual variability in the spermatogenic activity and on the amount of sperm stored.. In New Caledonia the spawning period of this species occurs during southern Summer (Lehodey *et al.*, 1997), interestingly the range of the oocyte diameters recorded is similar to the one obtained by Menezes *et al.* (2001).

The comparison between island and bank areas revealed that more immature specimens (males and females) were present in the island areas in all studied seasons. During Autumn and in bank areas a greater percentage of developing individuals (Stage II) were recorded for both sexes (Menezes *et al.* 2001).

16.6 Assessment

As in previous years, the Working Group attempted no assessment due to the lack of the basic data.

16.7 Biological reference points

As the Working Group carried out no assessment, no biological reference points have been considered.

16.8 Comments on the Assessment

No comments because no assessment.

16.9 Management considerations

The stock structure of alfonsino is not clear (Menezes *et al.* 2001), and the possible interactions of the fishing activities on the Mid Atlantic Ridge outside the Azores EEZ and the landings of alfonsino from the traditional fishery within the Azorean EEZ, continues to be uncertain.

Russian investigations in the MAR region (Vinnichenko, 2002), suggest that *B. splendens* has relatively isolated populations on each of many oceanic seamounts, and that alfonsino stocks were intensely exploited on most exploitable seamounts in the previous decade. Management of these species must take into account their limited spatial scale of distribution on seamounts, and the fishing activities in international waters.

Table 16.1 - Alfonsinos. Working Group estimates of landings (tonnes).

ALFONSINOS (*Beryx* spp.) IV

Year	France	TOTAL
1988	0	0
1989	0	0
1990	1	1
1991	0	0
1992	2	2
1993	0	0
1994	0	0
1995	0	0
1996	0	0
1997	0	0
1998	0	0
1999	0	0
2000	0	0
2001	0	0

ALFONSINOS (*Beryx* spp.) Vb

Year	Faroes	France	TOTAL
1988			0
1989			0
1990		5	5
1991		0	0
1992		4	4
1993		0	0
1994		0	0
1995	1	0	1
1996	0	0	0
1997	0	0	0
1998	0	0	0
1999	0	0	0
2000	0	0	0
2001	0	0	0

ALFONSINOS (*Beryx* spp.) VI and VII

Year	France	E & W	Spain	TOTAL
1988				
1989	12			12
1990	8			8
1991				0
1992	3			3
1993	0		1	1
1994	0		5	5
1995	0		3	3
1996	0		178	178
1997	17	4	4	25
1998	10	0	71	81
1999	67	0	20	87
2000		2	98	100
2001			103*	103*

* preliminary

ALFONSINOS (*Beryx* spp.) VIII and IX

Year	France	Portugal	Spain	E & W	TOTAL
1988					
1989					
1990	1				1
1991					0
1992	1				1
1993	0				0
1994	0		2		2
1995	0	75	7		82
1996	0	43	45		88
1997	69	35	31		135
1998	1	9	259		269
1999	8	29	161		198
2000		40	116	4	160
2001		43	181*		224*

* preliminary

Table 16.1 continued

ALFONSINOS (*Beryx* spp.) X

Year	Faroes	Norway	Portugal	Russia	E & W	TOTAL
1988			225			225
1989			260			260
1990			338			338
1991			371			371
1992			450			450
1993		195	533			728
1994		0	636	864		1500
1995	0	0	523	100		623
1996	0		536			536
1997	5		378	600		983
1998	0		228			228
1999	0		175			175
2000			209	5	15	229
2001			199			199

ALFONSINOS (*Beryx* spp.) XII

Year	Faroes	TOTAL
1988		0
1989		0
1990		0
1991		0
1992		0
1993		0
1994		0
1995	2	2
1996	0	0
1997	0	0
1998	0	0
1999	0	0
2000	0	0
2001	0	0

ALFONSINOS (*Beryx* spp.) in Madeira (Portugal)

Year	Portugal	TOTAL
1988		0
1989		0
1990		0
1991		0
1992		0
1993		0
1994		0
1995	1	1
1996	11	11
1997	4	4
1998	3	3
1999	2	2
2000		
2001		

ALFONSINOS (*Beryx* spp.). All ICES areas

Year	IV	Vb	VI+VII	VIII+IX	X	XII	TOTAL
1988	0	0	0	0	225	0	225
1989	0	0	12	0	260	0	272
1990	1	5	8	1	338	0	353
1991	0	0	0	0	371	0	371
1992	2	4	3	1	450	0	460
1993	0	0	1	0	728	0	729
1994	0	0	5	2	1500	0	1507
1995	0	1	3	82	623	2	711
1996	0	0	178	88	536	0	802
1997	0	0	25	135	983	0	1143
1998	0	0	81	269	228	0	578
1999	0	0	87	198	175	0	460
2000	0	0	100	160	224	0	484
2001	0	0	103*	224*	199	0	199

* preliminary

Table 16.2 - Age-length key for alfonsino *Beryx decadactylus*. (From Menezes *et al.* 2001)

Size class FL (cm)	Age group (year)								Total
	II	III	IV	V	VI	VII	VIII	IX	
20	2								2
21									0
22	4								4
23	6								6
24	17								17
25	12								12
26	9	1							10
27	5	3	1						9
28	9	4							13
29	3	2	1						6
30	1	9	2						12
31	1	6							7
32	2	3	2	1					8
33	1	3	4	1					9
34		5	3	4					12
35		3	3	6	1				13
36				4					4
37			4	4	4				12
38				1	2	1			4
39					6	1			7
40				1	2	1			4
41			1	2		6			9
42				3	3	5			11
43					1	2	1		4
44						4	1		5
45					3	1	2		6
46					2	1			3
47					1	1		1	3
48					1			1	2
49							1		1
50									0
51									0
N	72	39	21	27	26	23	5	2	215
X	26.03	31.35	34.21	37.13	41.42	42.80	45.70	48.00	
SD	2.60	2.48	3.20	2.90	3.65	2.14	2.28	0.71	

Table 16.3 - *Beryx decadactylus*. Parameters of the von Bertalanffy growth equations (From Menezes *et al.* 2001).

	Loo	se	K	se	to	se	N
Both sexes	59.15	7.36	0.141	0.04	-2.08	0.62	215
Females	56.87	6.26	0.165	0.05	-1.69	0.63	109
Males	63.12	29.27	0.11	0.11	-2.96	2.08	95

Table 16.4 - Age-length key for alfonsino *Beryx splendens*. (From Menezes *et al.* 2001)

Size class FL (cm)	Age group (year)							Total
	I	II	III	IV	V	VI	VII	
16	3							3
17	3							3
18	6							6
19	6	3						9
20	7	15	1					23
21	13	17	3					33
22	5	22	4					31
23	2	32	13	1				48
24	1	21	13	2				37
25		10	12	10	1			33
26		5	24	10	1			40
27		3	12	12	4	2		33
28		1	16	25	6			48
29			8	22	7	1		38
30		1	4	13	6	1		25
31				6	8	5		19
32				6	10	5		21
33				2	7	3	1	13
34				1	3	1		5
35					2	2		4
36						1		1
N	46	130	110	110	55	21	1	473
X	20.37	23.25	26.23	28.78	31.06	32.26	33.5	
SD	1.95	1.95	2.27	2.14	2.36	2.32		

Table 16.5 - *Beryx splendens*. Parameters of the von Bertalanffy growth equations. (From Menezes *et al.* 2001)

	Loo	se	k	se	to	se	N
Both sexes	44.99	6.25	0.14	0.047	-3.13	0.68	473
Females	45.33	8.92	0.141	0.067	-3.09	0.96	247
Males	45.07	10.27	0.134	0.074	-3.33	1.17	215

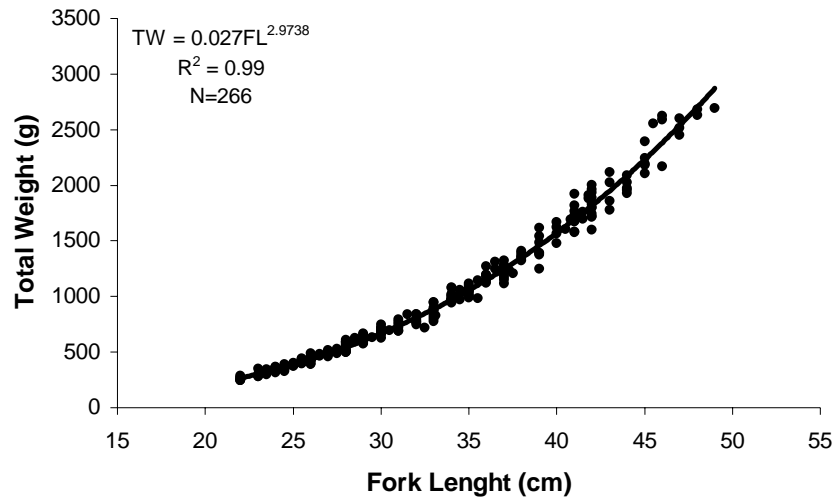

Figure 16.1- *Beryx decadactylus*. Relationship between fork length and total weight (TW – total weight; FL – fork length; r – regression coefficient; N-number of individuals) (From Menezes *et al.* 2001)

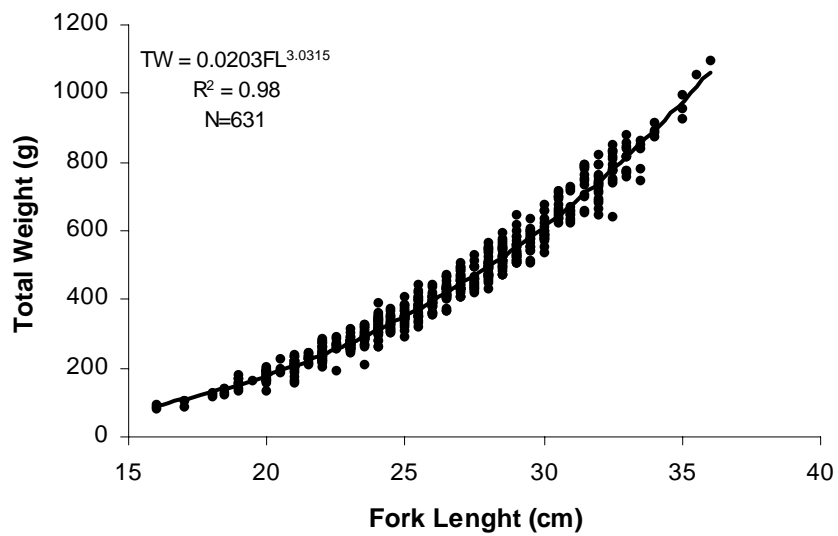

Figure 16.2 -*Beryx splendens*. Relationship between fork length and total weight (TW – total weight; FL – fork length; r – regression coefficient; N-number of individuals). (From Menezes *et al.* 2001)

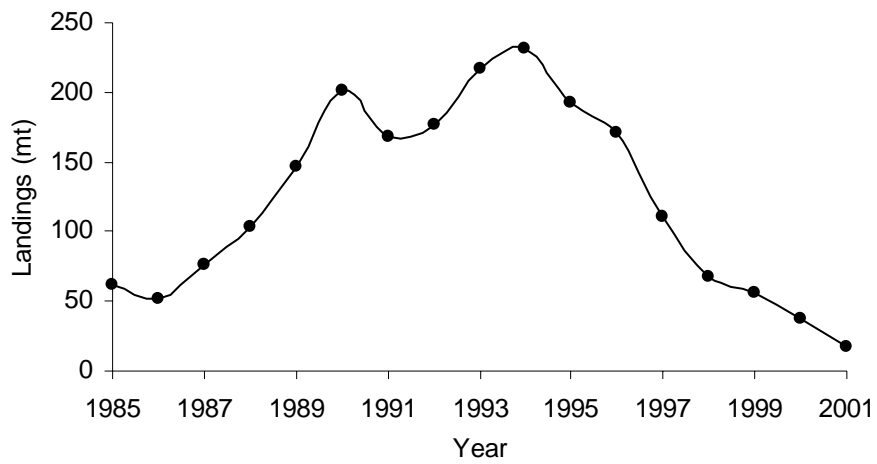

Figure 16.3 *Beryx decadactylus* landings in the Azores region (ICES Sub-Area X), in the period 1985-2001.

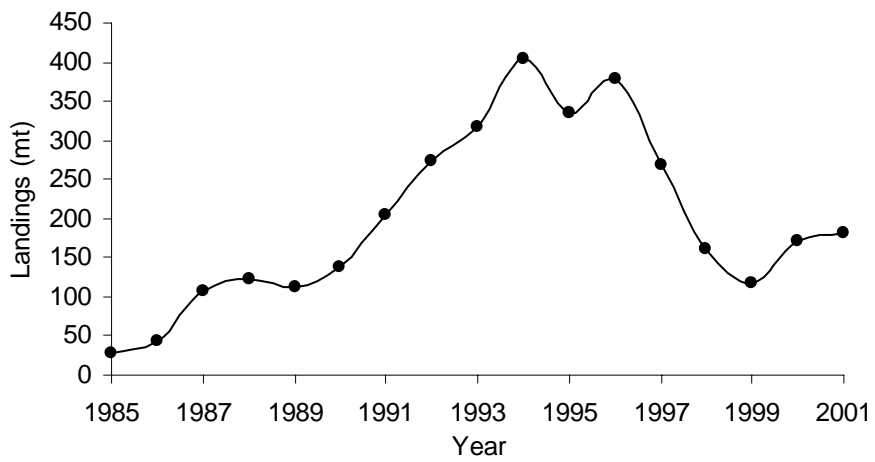

Figure 16.4 *Beryx splendens* landings in the Azores region (ICES Sub-Area X), in the period 1985-2001.

17 DEEPWATER SQUALID SHARKS *CENTROPHORUS SQUAMOSUS* AND *CENTROSCYMNUS COELOLEPIS*

Deepwater squalid sharks are taken in several mixed and directed fisheries. A first preliminary assessment was attempted by SGDEEP in 2000. Further preliminary assessments of these species will be attempted at the forthcoming meeting of SGEF in May 2002. This work is being supported by the EU Study Contract DELASS (Section 2.3.5). WGDEEP has compiled available landings data for deepwater sharks and examined existing CPUE time series. Close communication will be maintained with SGEF in the assessment of deepwater sharks.

17.1 Catch Trends

Landings data for deepwater sharks are only available from some countries. However they are often reported as mixed deepwater sharks, rather than to species level. Considerable progress has been made by some countries in collecting deepwater shark data. However, only Portugal, Iceland, Faroe Islands and Denmark regularly record landings to species level for deepwater sharks and Spain has begun to report species specific data for Hatton Bank. Table 17.1 presents available landings data for deepwater sharks, where available, and data for sharks (various) where it is known that such landings comprise some deepwater species. It is difficult to detect trends because of the unknown landings of deepwater species in the various categories.

There have been no reported landings of sharks in Sub-areas I and II since 1990 (ICES, 2000a) and those data almost certainly referred to *Somniosus microcephalus*, the Greenland shark.

Landings data for *Etmopterus spinax* the velvet belly in Division IVa rose to over 350 t in 1998, but declined to 52 t in 2001. Landings of deepwater sharks (almost exclusively *C. squamosus* and *C. coelolepis*) by France, UK (E and W) and UK (Scotland) probably refer to fisheries west of the Shetland Isles. English/Welsh and Scottish landings have been small in most years, and French landings have declined from a maximum of just over 130 t in 1992.

Landings of *S. microcephalus* by Iceland in Division Va have fluctuated between 30 and 82 t since 1989. Whilst *C. coelolepis* occurs in this area landings are infrequent.

In Division Vb France has had the largest landings, fluctuating around 200 to 300 t in most years, though reaching a peak of 460 t in 1999. There have been some catches of *C. coelolepis*, and in 2001 of *C. squamosus* also, by the Faeroe Islands. UK (E and W) and UK (Scotland) have begun to collect separate landings data for deepwater sharks (almost exclusively *C. squamosus* and *C. coelolepis*) since 1999, but it is not possible to ascertain what proportion of earlier landings records for these countries, or Germany, were deepwater sharks.

Division VIa is one of the most important areas for fisheries for deepwater sharks. *C. squamosus* and *C. coelolepis* are taken in the mixed species trawl fishery by France. Separate statistics are unavailable from France before 1999, but French landings data for Sub-area VI rose from 900 t in 1991 to over 2400 t in 1993, and have fluctuated around 2000 t in most years since. Most recent French landings for Divisions VIa and VIb have been the highest in the series. UK (E and W) and UK (Scotland) landings of various sharks before 1999 included an unknown quantity of deepwater sharks. The English/Welsh landings increased steadily throughout the 1990s to 2 700 t in 1997 and include deepwater sharks taken by demersal longliners. Some of the Scottish landings of sharks in these years include a bycatch of deepwater species from directed fisheries for anglerfish and blue ling, and are probably mainly *C. squamosus*. Spanish landings from Sub-areas VI and VII also contain an unknown deepwater shark component, mainly from longline fisheries. Fluctuations in the market for livers may lead to fluctuations in the Spanish landings.

Recent French landings reported from VIb have been less than 500 t, from the slopes of the Rockall Bank. Irish, Scottish and English/Welsh landings of deepwater sharks have been reported separately since 1999. Developing Spanish trawl fisheries on Hatton Bank (Sub-area XII and Division VI b) take a bycatch of sharks. *C. coelolepis* is the most important species, though other smaller squalids are landed too. A developing Norwegian longline fishery on Hatton Bank takes a bycatch of deepwater sharks too, mainly *C. coelolepis*. There have been small landings of deepwater sharks from Sub-area XII since the early 1990s.

In Sub-area VII there are longline fisheries prosecuted by Spain, England/Wales and Ireland. The Irish fishery is a new development, but English/Welsh and Spanish vessels have targeted deepwater sharks throughout the 1990s, though it is impossible to detect stock trends from landings. French trawl landings reached a peak of 1360 t in 1994, and have declined to near 400 t in 2001. French trawlers have begun to land the black dogfish *Centroscyllium fabricii* in most recent years, in all areas.

There have been Spanish, French, English/Welsh and Scottish landings of sharks in Sub-area VIII, but the deepwater component is unknown. There are directed longline fisheries in this area for sharks.

Portugal collects species-specific landings data from artisanal longline fisheries in Division IXa. This fishery began in 1980 and takes place from the ports of Sesimbra, Peniche and Viana do Castelo. There has been a marked decline in landings of gulper shark, *Centrophorus granulosus*, from over 1000 t in 1989 to around 50 t in 2000. This species is mainly landed in Viana do Castelo. Landings of *C. squamosus* and *C. coelolepis* have fluctuated around 500 and 700 t respectively. Between 1996 and 1998 there was an increase in *C. coelolepis* and a decrease in *C. squamosus*. These two species are landed mainly at Sesimbra. Landings of *Dalatias licha* have declined to very low levels.

In Sub-area X Portugal (Azores) there was a directed longline fishery for *D. licha* but landings have declined to a very low level, and is now taken as a bycatch in demersal longline fisheries. The market price of the species, rather than stock declines, probably explains this decline. There were landings of *C. squamosus* in an exploratory black scabbard longline fishery and other deepwater species, such as *Deania calceus* and *D. profundorum* are also taken, though not reported separately.

In Sub-area XII there have been some French landings of deepwater sharks, but it is not possible to detect any trends from these data.

17.2 Stocks

Stock structure is unclear in these wide-ranging deepwater squalid sharks. Both *C. squamosus* and *C. coelolepis* are present all along the continental margins from Iceland to Portugal and along the Mid-Atlantic Ridge. *D. licha* and *C. granulosus* have more southerly distribution in Sub-areas IX and X. There is little information on stock discrimination of deep-water sharks, few genetic studies have been carried out, and none in the ICES area. However there are some data that support the view that deep-water sharks are highly migratory. Clark and King (1989) found a cyclical migration around the North Island, New Zealand and suggested that breeding aggregations are localised. The continental slopes of Portugal are populated by *Deania calceus* of smaller size (Machado and Figueiredo, 2000) than those present west of Ireland or Scotland (Clarke et al. 2002). Gravid female *Centrophorus squamosus* have been recorded in Madeira and Portugal. However there are no records of any gravid females from west of Ireland or Scotland despite intensive sampling (Girard and Du Buit, 1999), where less than 15 % of female *Centrophorus squamosus* were mature.

17.3 Commercial CPUE and Research Surveys

A series of CPUE from a reference fleet of French trawlers for *Centroscymnus coelolepis* and *Centrophorus squamosus*, collectively called “sikis”, was available for 1990 to 2001. This time series is different to that considered by SGDEEP in 2000 (ICES, 2000a), due to changes in database formats (Section 2.2). Both time series of catch and effort are presented in Table 17.2 and are compared in Figure 17.2. Closest similarity was for Sub-area VII, followed by Sub-area VI. The series for Sub-area V were not similar and for all areas combined. The WGDEEP 2002 series produced lower abundance estimates in each case, since it represents total effort, rather than effort directed at deepwater squalid sharks.

The time series for Sub-area VI, where most effort takes place, both displayed downward trends until 1998. The WGDEEP 2002 series did not display the high peak in the SGDEEP 2000 series for 1991. However the value for 2001 is the highest since 1994. There is no similar upward trend for the other sub-areas, so it is unclear what the reasons for this trend are. However the series for the Sub-areas combined displayed the same trend, indicating the importance of Sub-area VI effort on these sharks. Indeed the 2001 value is the highest recorded in the combined series.

17.4 Length and age composition

Length frequencies for *C. squamosus* and *C. coelolepis* from Irish longline surveys are presented in Figure 17.3, for 2000. Figure 17.4 shows length frequencies for *C. coelolepis* from Spanish commercial trawlers on Hatton Bank in 2001 (Duran Muñoz et al. WD, 2002), whilst length frequencies of *C. coelolepis* from Norwegian exploratory longline fishing in 2001 are presented in Figure 17.5 (Hareide et al., WD, 2002). Length frequencies and length at maturity from French port sampling is presented in Figures 17.6 and 17.7 for *C. squamosus* and *C. coelolepis* respectively (Girard, 2000). Figure 17.8 presents length frequencies for *C. coelolepis* from artisanal longline fisheries in Portugal (IXa).

Age estimates from dorsal fin spines of *C. squamosus* ranged from 21–70 years (Clarke et al. 2002). The absence of smaller and younger specimens of this species from Sub-areas VI and VII has been well documented (Girard and DuBuit, 1999, Clarke et al. 2001), however gravid females do occur at Madeira and further south off Senegal (Cadenat

and Blache, 1981). Age estimates and growth parameters for *D. calceus* in the NE Atlantic were reported by Machado and Figueiredo (2000) and Clarke et al. (2002). Age estimates and growth parameters of *C. granulosus* are available for Mediterranean waters (Guallart, 1998).

17.5 Biological parameters

There are no growth parameters available for any commercially important deepwater shark in the NE Atlantic, because the lack of smaller individuals from wide areas has hampered growth studies. Length-weight relationships for *C. coelolepis* and *C. squamosus* were presented in 2000 (ICES 2000a) and available biological parameters were tabulated last year (ICES 2001a). The contrast in life history strategies of these two main commercial species is important. *C. squamosus* has a lower fecundity than *C. coelolepis*. But *C. squamosus* may be less vulnerable to exploitation in Sub-areas V, VI and VII because most mature, and all gravid, females are absent from this region (Girard, 2001). Mature and gravid *C. coelolepis* occur in shallower waters than immatures or males (Clarke et al. 2001). The smallest size groups of both these species are totally absent from Sub-areas V, VI and VII (Girard and DuBuit, 1999; Clarke et al. 2001). Available biological data for the two species considered by WGDEEP in 2001 are presented separately in the text table below. It is important to point out that these species have different life histories.

Parameter	Value	Reference
<i>Centroscymnus coelolepis</i>		
Longevity		
Ovarian fecundity	8-22*	Girard & DuBuit, 1999
Uterine Fecundity	8-19*	Girard & DuBuit, 1999
Length at maturity	86, 99	Girard & DuBuit, 1999
<i>Centrophorus squamosus</i>		
Longevity	53 (m), 70 (f)	Clarke et al. 2002
Natural mortality	0.09 (m), 0.07 (f)	Clarke et al. 2001
Ovarian fecundity	7-11* (mean = 10)*	Girard & DuBuit, 1999
Uterine Fecundity	5*	Cadenat & Blache, 1981
Length at maturity	98 (m), 120 (f)	Girard & DuBuit, 1999

* Fecundity per year unknown

17.6 Assessment

No assessment was conducted. The only available time series was for a combination of two species, *C. squamosus* and *C. coelolepis* and was considered unreliable because each has different life-history strategies and bathymetric distributions. The interpretation of such combined CPUE series can be misleading and may mask important discrepancies in the trends in each of the constituent species. Disaggregation of this CPUE series was not possible, due to lack of time series of market sampling from the reference fleet. Alternative reference fleets will be investigated. Another problem is that total international catch is underestimated because of some sharks being reported only in the category of various sharks.

Given that suitable CPUE time series will only become available slowly for deepwater squalid sharks, assessments using such data will be hampered in the short and medium term. An alternative approach, using life history models, incorporating known information on individual species' biology, could be applied to these species. Such an approach is detailed by Figueiredo *et al.* (2002, WD).

17.7 Comments on assessment

Further work on assessment methodologies will be carried out at the forthcoming meeting of SGEF.

17.8 Management considerations

Deepwater sharks are taken in mixed species trawl fisheries in Sub-areas V, VI, VII and XII. It is not possible to target squalids without getting a by-catch of other species, and fisheries taking other species such as black scabbard, roundnose grenadier, forkbeard and blue ling have a substantial by-catch of sharks. The various longline fisheries taking deepwater sharks also take forkbeards, *Mora*, Greenland halibut, and rabbitfish. However the species diversity in such fisheries is lower, and sharks tend to be a more dominant proportion of the catch. The mixed-species character of these trawl and longline fisheries makes them difficult to manage according to a single species regulation. There is no information on gill-net fisheries for deepwater sharks, though it is known that there are such fisheries. Further data are required on catch and effort in these fisheries.

Table 17.1 Working group estimates of landings of deepwater sharks, and of sharks not elsewhere identified (various) that are known to contain some landings of deepwater species. Landings data indicated as “deep” For France, Ireland and the UK are almost exclusively *C. coelolepis* and *C. squamosus*. In the case of other countries they may contain some other species. Data for 2001 are preliminary. “Aiguillat noir” is a new category of small squalids and are considered separately from the main commercially important squalid sharks in the summary landings tables.

Sharks landings in Division IV a.

Year	France		Denmark	UK (E & W)	UK (Scot.)
	deep	aiguillat. noir	<i>E. spinax</i>	various	various
1991	3				
1992	133				
1993	51		27		
1994	86		0		
1995	10		10		
1996	6		8		
1997			32		
1998			359		
1999	20		128		53
2000	0	1	25	2	8
2001	0		52	0	10

Table 17.1. Continued. Sharks landings in Division V a.

	Iceland		Germany
	<i>S. microcephalus</i>	<i>C. coelolepis</i>	various
1988			
1989	31		
1990	54		3
1991	58		133
1992	70		51
1993	39		86
1994	42		10
1995	45		6
1996	65		
1997	70		
1998	82	5	20
1999	45		0
2000	45		0
2001	56		

Table 17.1. Continued. Sharks landings in Division V b.

	France	Norway	Germany	UK (E & W)		Scotland		Faroe Islands <i>C. coelolepis</i>	
	deep	deep	various	deep	various	deep	various	various	
1990	140								
1991	75							3	
1992	123				5			36	
1993	91		2		9			376	
1994	149		43						
1995	262								
1996	348		31		1				
1997	261		27		20				
1998	354								79
1999	461		1				8		
2000	306	0	0		54	11	15	2*	23
2001	297	25	0	4	93	5	119	576**	

* *Centrophorus squamosus*

** *Centrophorus squamosus* and *Centroscymnus coelolepis*.

Table 17.1. Continued. Shark landings in Division VI a.

	France a. noir	Ireland	Norway	Germany	UK (E & W)		UK (Scot.)		
	deep	deep	deep	various	deep	various	deep	various	
1999	1651							136	
2000	2124	127	21	0	1	244	119	181	25
2001	2332	120	21	149	8	98	24	386	36

Table 17.1. Continued. Shark landings in Division VI b.

	France <i>C. fabricii</i>	Ireland	Norway	Germany	UK (E & W)		UK (Scot)		
	Siki	deep	deep	various	deep	various	deep	various	
1999	472							112	
2000	346	1		41	177	26	220	24	23
2001	247	4	5	83	34	219	168	127	8

Table 17.1. Continued. Shark landings in Division VI b taken by Spain on Hatton Bank

	<i>C. squamosus</i>	<i>C. coelolepis</i>	<i>D. calceus</i>	<i>C. repidater</i>	<i>C. fabricii</i>	<i>Etmopterus sp.</i>
2000	0	33	0	0	1	0
2001	0	120	0	0	0	21

Table 17.1. Continued. Shark landings reported in Sub-areas VI and VII

	France deep (VI only)	Spain various	Germany various	UK (E & W) various	UK (Scot.) various	Faeroe Islands various
1988		66		19		
1989				32	8	
1990				38	5	
1991	944			201	53	
1992	1953			503	133	3
1993	2454		124	821	447	
1994	2198		395	742	727	
1995	1784		2	1315	782	
1996	2374		276	1345	555	
1997	2222	152	66	2721	301	
1998	2081	645	65	1812	501	
1999		199	189	1403		
2000		8				
2001		0				

Table 17.1. Continued. Shark landings in Sub-area VII.

	France deep	France <i>C. fabricii</i>	Ireland deep	Germany various	UK (E & W) deep	UK (E & W) various	UK (Scot.) deep	UK (Scot.) various
1991	265							
1992	878							
1993	857							
1994	1363							
1995	991							
1996	754							
1997	571							
1998	673							
1999	440							244
2000	506	4	92	85	23	76	0	3
2001	417	6	159	164	353	130	103	21

Table 17.1. Continued. Deepwater shark landings taken by Portugal in Division IX a.

Year	<i>C. granulosus</i>	<i>C. squamosus</i>	<i>C. coelolepis</i>	<i>D. licha</i>	<i>G. melastomus</i>
1988	995	560	na	149	21
1989	1027	507	na	57	17
1990	1056	475	na	7	17
1991	801	424	651	12	17
1992	958	422	692	11	16
1993	886	339	607	11	20
1994	344	579	576	11	37
1995	423	544	810	7	29
1996	242	412	777	4	35
1997	291	384	927	4	29
1998	187	362	858	6	22
1999	92	428	544	6	23
2000	54	438	611		
2001	93	510	620	7	35

Table 17.1. Continued. Shark landings in Sub-areas VIII and IX.

Year	Spain various	France deep (VIII only)	UK (E& W) various	UK (Scot.) various
1988	3545			
1989	1789			
1990	na			
1991	2850			
1992	3740	15	0	0
1993		9		0
1994		8		4
1995		0	32	7
1996		1	25	0
1997	1059	1	20	
1998	1811	13		
1999	476	20		
2000	228	21		
2001	321	5		

Table 17.1. Continued. Deepwater shark landings taken by Portugal (Azores) in Sub-area X.

	<i>C. squamosus</i>	<i>D. licha</i>
1988		549
1989		560
1990		602
1991		896
1992		761
1993		591
1994		309
1995		321
1996		216
1997		30
1998	4	34
1999	8	31
2000		31
2001		13

Table 17.1. Continued. Shark landings in Sub-area XII

	France deep	France <i>C. fabricii</i>	Ireland deep	Norway deep	UK (E & W) various	UK (Scot) deep	UK (Scot) various
1991	1						
1992	2						
1993	6						
1994	8						
1995	139						
1996	147						
1997	32						
1998	56						
1999	50						
2000	190	3		77	35	3	3
2001	23	2	29	142		36	

Table 17.1. Continued. Shark landings in Sub-area XII caught by Spain on Hatton Bank

	<i>C. squamosus</i>	<i>C. coelolepis</i>	<i>D. calceus</i>	<i>C. repidater</i>	<i>C. fabricii</i>	<i>Etmopterus</i> sp
2000	34	505	12	85	84	38
2001	2	493	5	68	91	317

Table 17.1. Continued. Summary of available landings data for large deepwater squalid sharks by Sub-area. No data were available for VIII from most countries.

Year	IVa	Va	Vb	VI	VII	VIII	IX a	Portugal	X Azores	XII	Total
1988								1704	549		2253
1989								1591	560		2151
1990			140					3129	602		3871
1991	3		75	944	265			3426	896	1	5610
1992	133		123	1953	878	15		3971	761	2	7836
1993	51		91	2454	857	9		3926	591	6	7985
1994	86		149	2198	1363	8		3353	309	8	7474
1995	10		262	1784	991	0		3294	321	139	6801
1996	6		348	2374	754	1		3219	216	147	7065
1997			261	2222	571	1		3041	30	32	6158
1998		5	433	2081	673	13		3019	38	56	6318
1999	20		461	2123	440	20		2483	39	50	5636
2000	1		342	3010	621	21		2173	31	951	7150
2001p	0		907	3679	1032	5		2333	13	1206	9175

P denotes preliminary data

Table 17.1. Continued. Total sharks (various, including some deepwater sharks) landings by Sub-areas.

Year	IVa	Va	Vb	VI	VII	VI+VII*VIII+IX	XII	Total	
1988						85	3545	3630	
1989		31				40	1789	1860	
1990		54	140			43	1789	2026	
1991	3	58	78	944	265	254	2850	1	4453
1992	133	70	164	1953	878	639	6590	2	10429
1993	78	39	478	2454	857	1392	3740	6	9044
1994	86	42	192	2198	1363	1864	4	8	5757
1995	20	45	262	1784	991	2099	43	139	5383
1996	14	65	380	2374	754	2176	64	147	5974
1997	32	70	308	2222	571	3240	1104	32	7579
1998	359	87	433	2081	673	3023	2890	56	9602
1999	201	45	470	2371	440	1791	2287	50	7655
2000	36	45	409	3704	789	8	704	1069	6764
2001p	62	57	543	4102	1353	0	549	1208	7874

* Some countries reported data for VI and VII combined, while others reported data separately for each Sub-area. The column for VI and VII combined shows data reported for both Sub-areas combined but does not contain landings for VI and VII reported separately.

Table 17.2. Deepwater squalid sharks, total available international catch, and total catch and effort from a reference fleet of trawlers in ICES Sub-areas V, VI and VII. Total international catch is an underestimate because of reporting of some deepwater squalids among various sharks.

ICES sub-area	Year	Total available international catch (t)	Data for the reference fleet			
			SGDEEP 2000		WGDEEP 2002	
			cpue (kg/h)	Catch (t)	effort (h)	cpue (kg/h)
V	1990	140	92	128	9354	14
V	1991	75	127	68	4320	16
V	1992	123	110	109	2321	47
V	1993	91	148	80	1137	70
V	1994	149	171	120	1288	93
V	1995	262	149	193	1992	97
V	1996	348	169	257	2053	125
V	1997	261	95	197	3373	58
V	1998	433	84	354	6105	58
V	1999	461		356	10119	35
V	2000	342		274	7961	34
V	2001	907		270	10336	26
VI	1990		143	245	5521	44
VI	1991	944	255	816	8634	95
VI	1992	1953	189	795	8373	95
VI	1993	2454	148	858	9088	94
VI	1994	2198	128	647	9222	70
VI	1995	1784	94	574	10129	57
VI	1996	2374	75	521	11244	46
VI	1997	2222	81	520	10028	52
VI	1998	2081	63	403	9347	43
VI	1999	2123		167	6027	28
VI	2000	3010		585	9914	59
VI	2001	3679		774	5702	136
VII	1990		0	0	21	0
VII	1991	265	84	222	3107	71
VII	1992	878	87	654	8882	74
VII	1993	857	107	576	5666	102
VII	1994	1363	104	758	7695	99
VII	1995	991	104	641	6401	100
VII	1996	754	97	363	4042	90
VII	1997	571	90	212	2685	79
VII	1998	673	88	273	3076	89
VII	1999	440		217	2992	73
VII	2000	621		158	2615	60
VII	2001	1032		115	2067	56
Combined	1990	140	114	373	14896	34
Combined	1991	1284	167	1106	16061	85
Combined	1992	2954	126	1558	19576	83
Combined	1993	3402	135	1514	15891	96
Combined	1994	3710	126	1525	18205	86
Combined	1995	3037	111	1408	18522	82
Combined	1996	3476	95	1141	17339	78
Combined	1997	3054	87	929	16086	59
Combined	1998	3187	73	1030	18528	60
Combined	1999	3024		740	19138	44
Combined	2000	3973		1017	20490	53
Combined	2001	5618		1159	18105	102

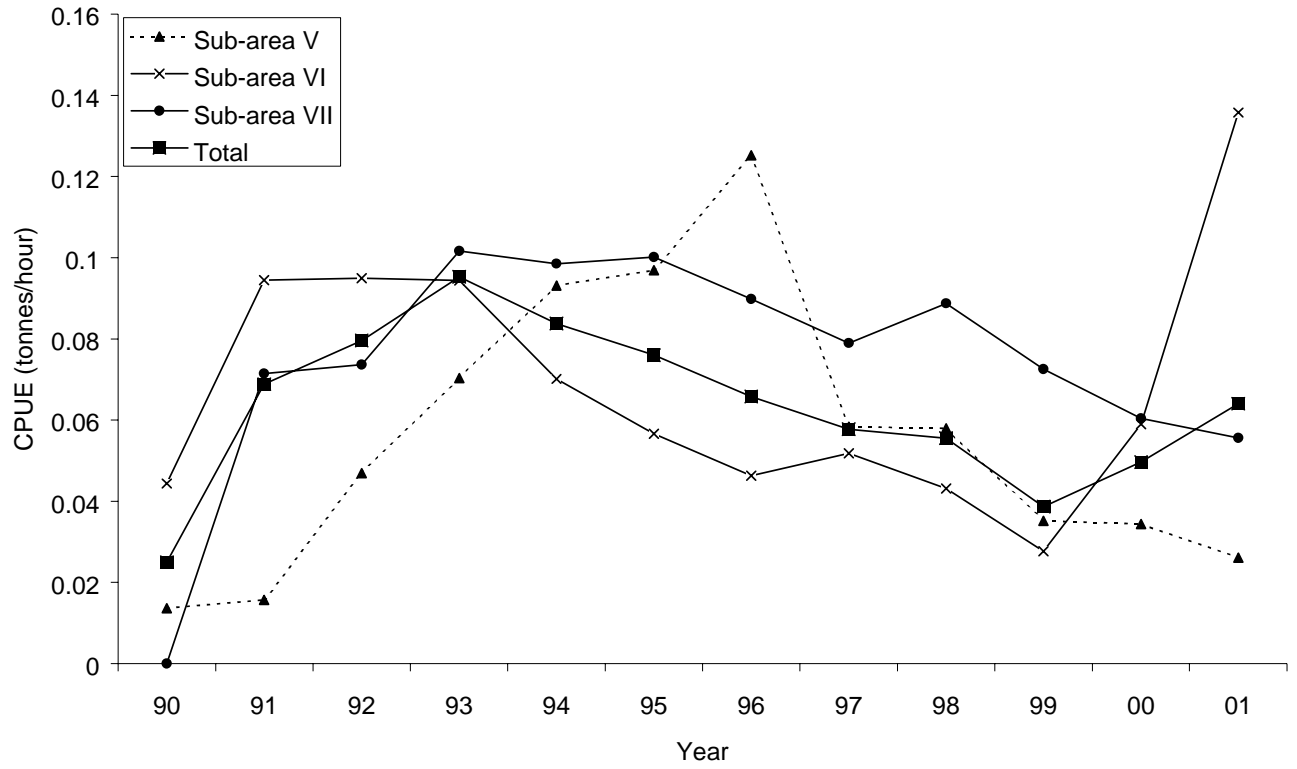

Figure 17.1. Total CPUE directed at deepwater fish by reference fleet of large French trawlers in tonnes per hour in ICES Sub-areas V, VI and VII.

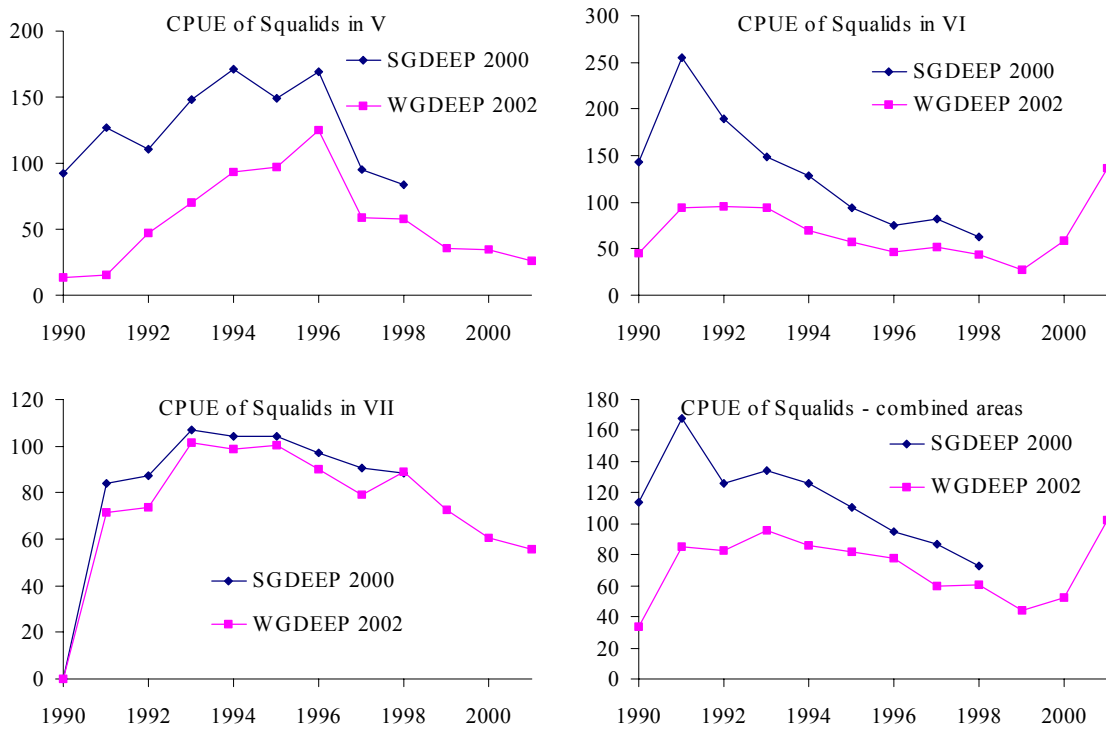

Figure 17.2. Comparison of two French time series of catch and effort for *Centrophorus squamosus* and *Centroscymnus coelolepis*. Series 1, 1990 to 1998 represents effort directed at these species, defined as Series 2, 1990 to 2001 represents total effort directed to all deepwater fish species

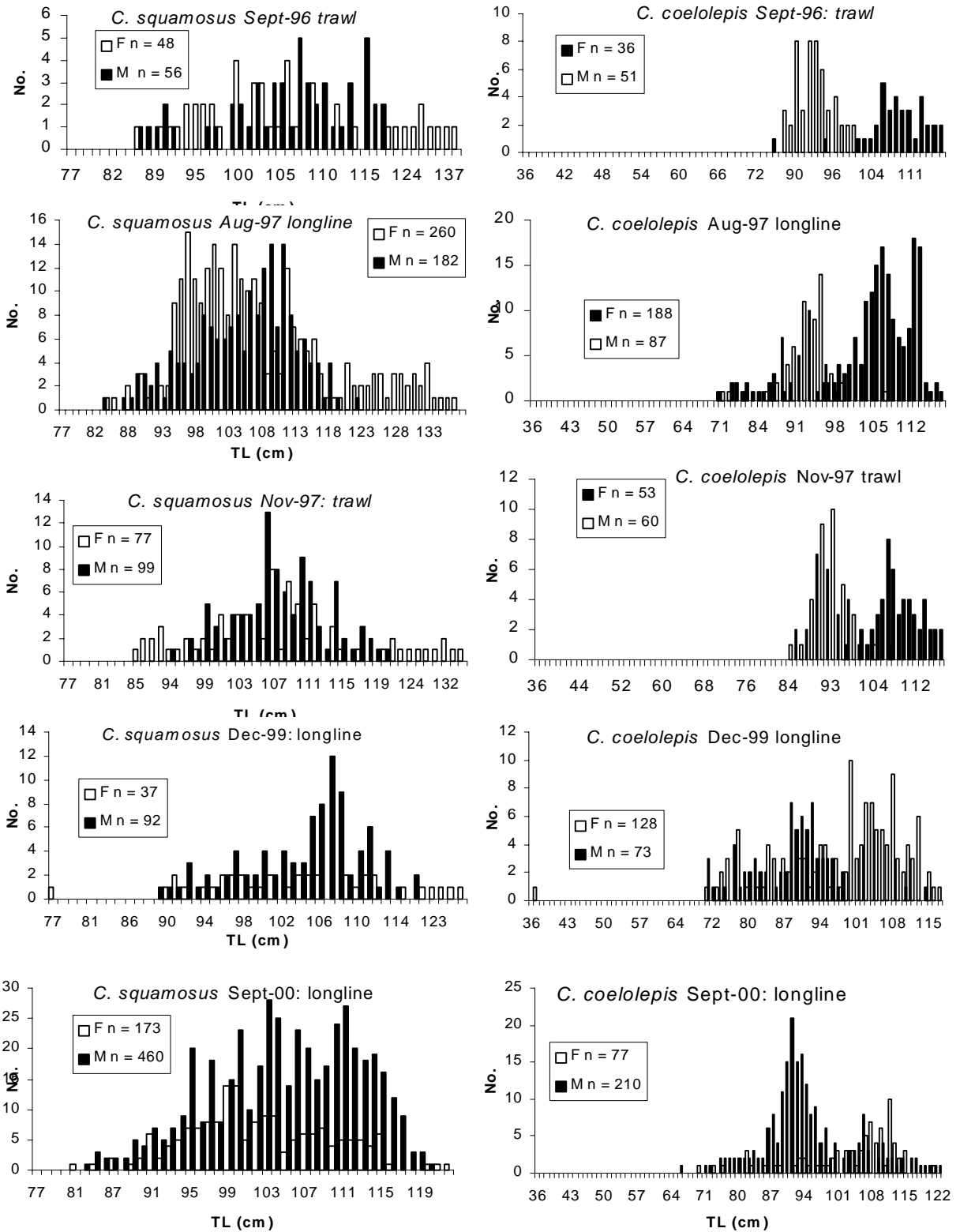

Figure 17.3. Length frequency for *Centrophorus squamosus* and *Centroscymnus coelolepis* from Irish research trawl and longline surveys of Sub-areas VI and VII 1996-2000.

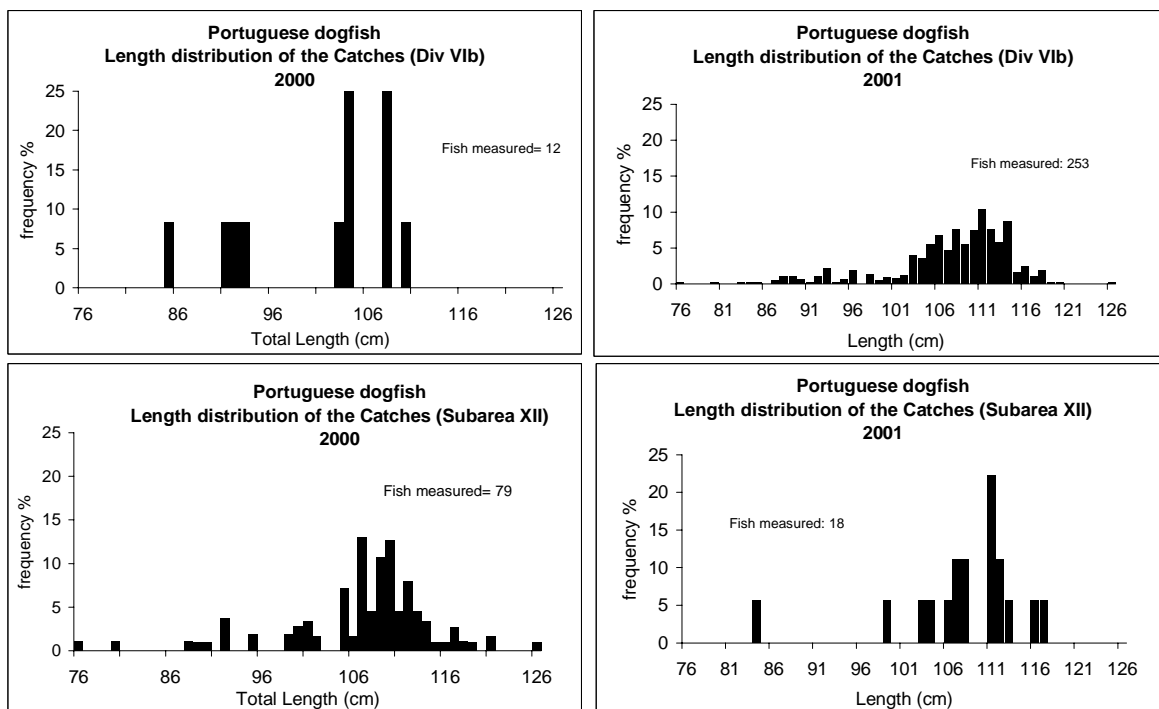

Figure 17.4. Length frequencies for *Centroscymnus coelolepis* from Spanish commercial fishing on Hatton Bank in 2001 using bottom trawl.

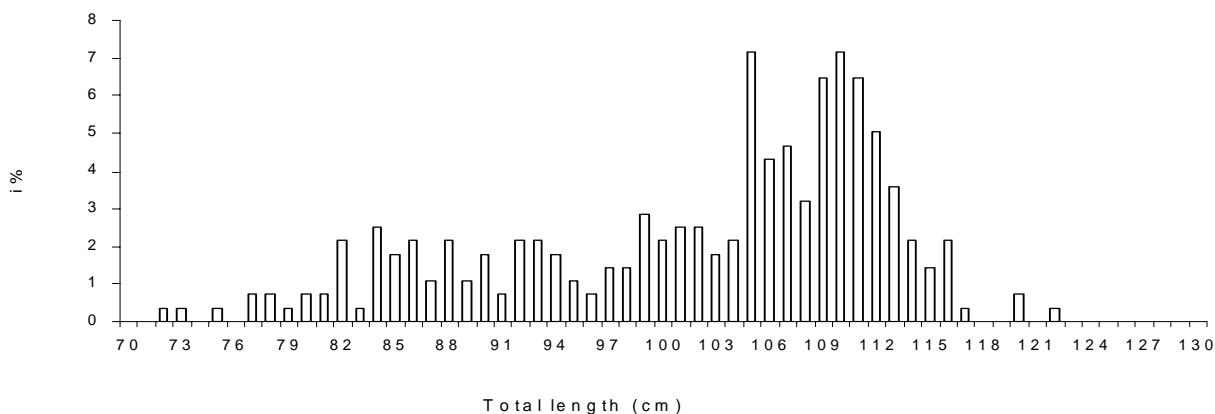

Figure 17.5. Length distribution for *Centroscymnus coelolepis* from Norwegian exploratory longline fishing on Hatton Bank (Sub-area XII and Division VI b) in 2001 (n=279).

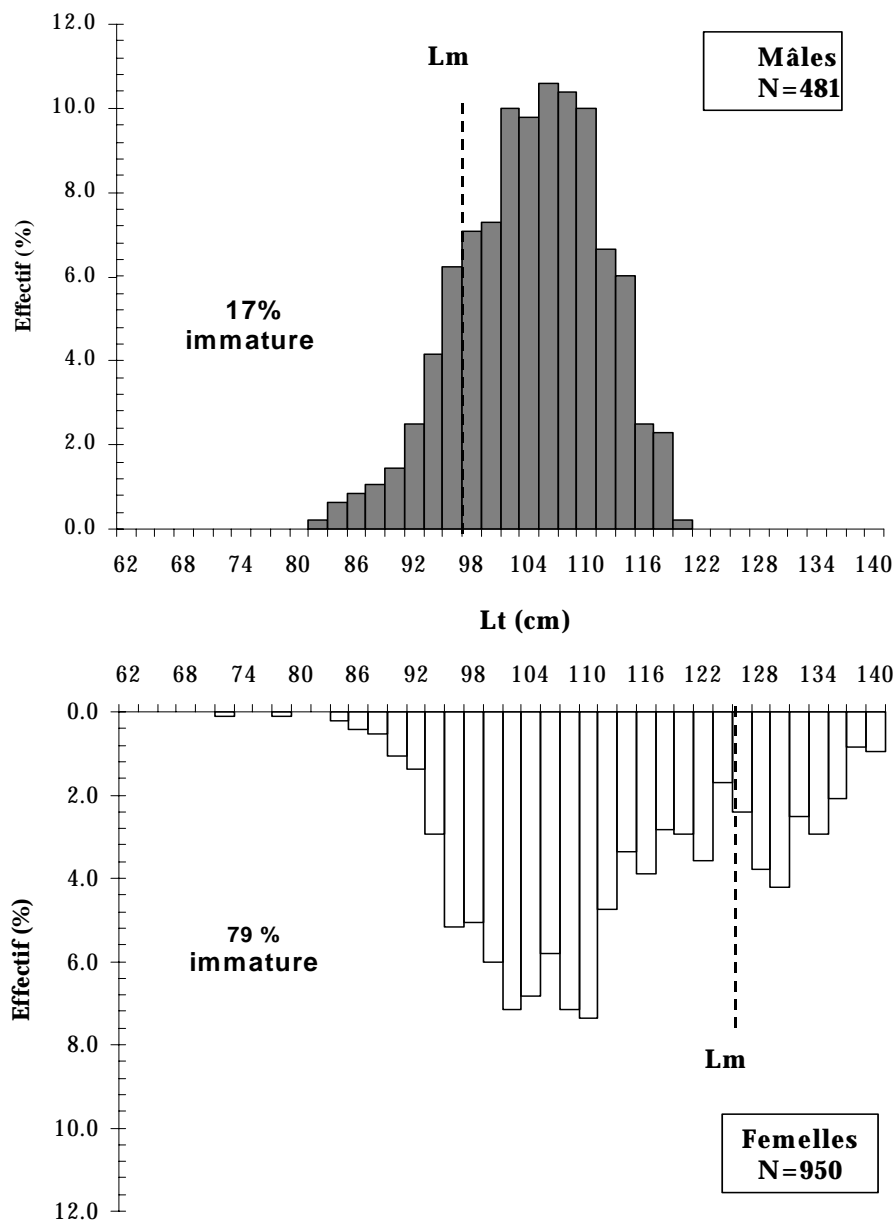

Figure 17.6. Length frequency for *Centrophorus squamosus* from Sub-areas VI and VII, 1995-1999 (Girard, 2000).

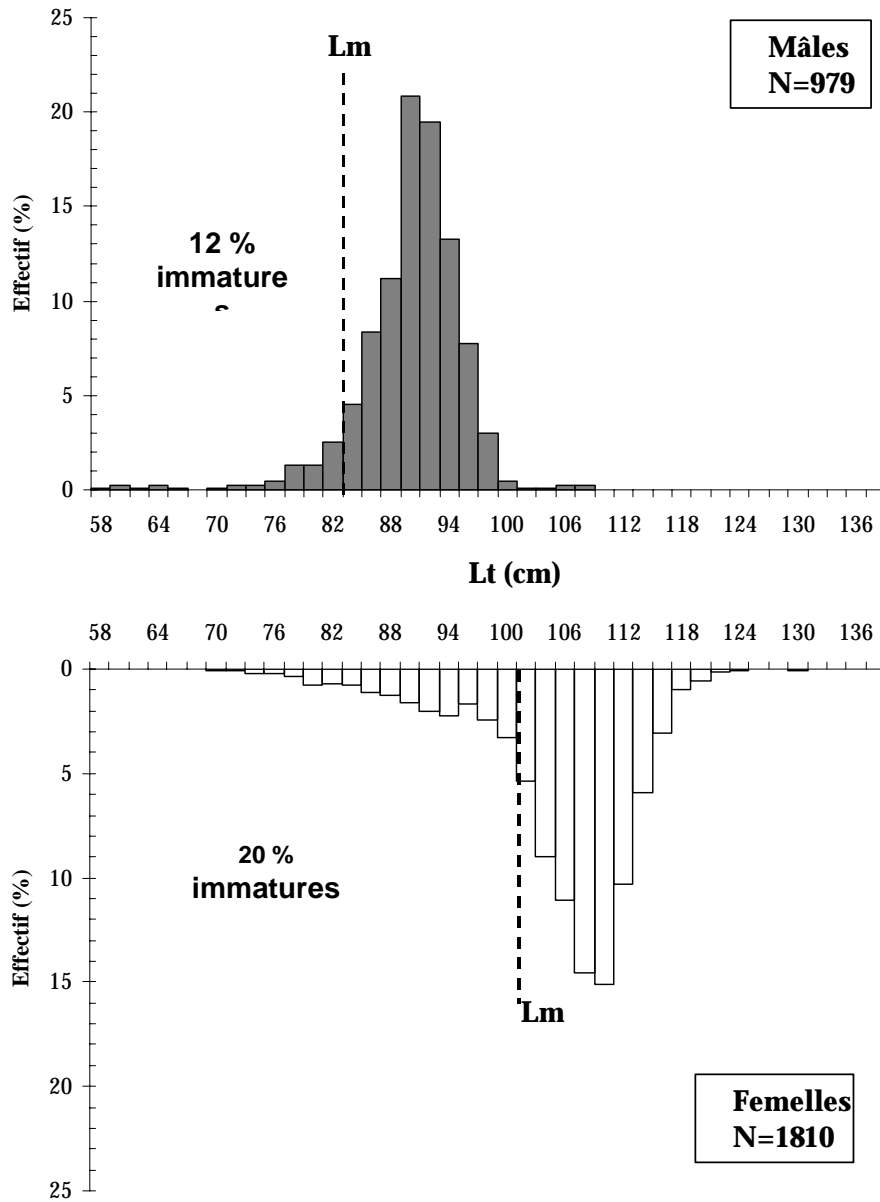

Figure 17.7. Length frequency for *Centroscyrnus coeloleis* from Sub-areas VI and VII, 1995-1999 (Girard, 2000).

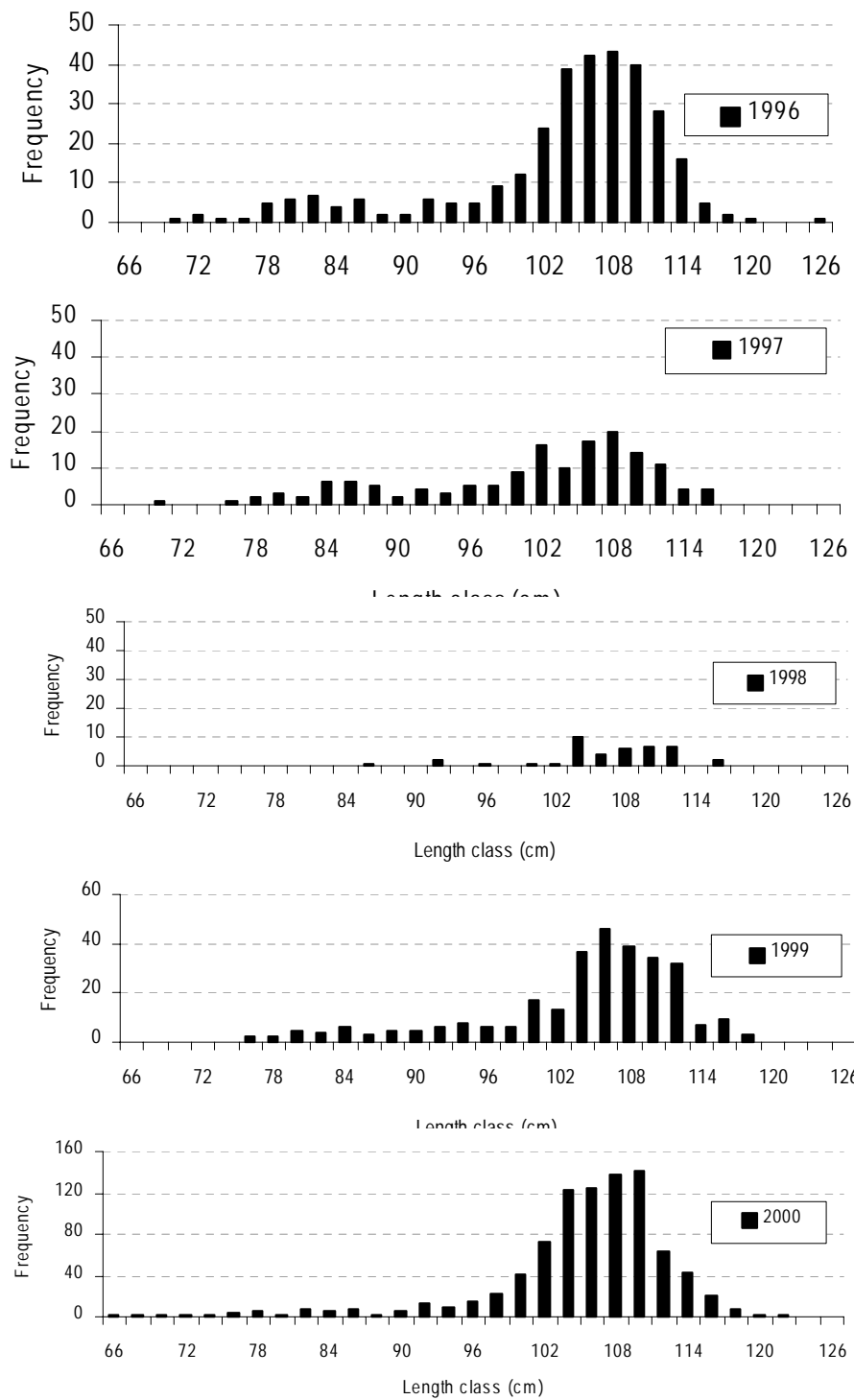

Figure 17.8. Length frequencies of *C. coelolepis* from Portugal IX a.

18 OTHER SPECIES

18.1 Exploratory fishing

Spain

In the year 2000 a Spanish bottom trawler conducted a spring deep-sea exploratory fishery in the North Atlantic international waters (Durán Muñoz WD 2000), inside the ICES area (XII and XIVb) and outside (South to Azores). The main catches were blue ling (21t. in XII + 129t. in XIVb), Greenland shark (20t. in XVIb), roundnose grenadier (10t. in XII), atlantic halibut (5t. in XII) and portuguese dogfish (1t in XII + 2t in XIVb). In the year 2001, no deep-sea Spanish exploratory fishery was conducted in this area.

Norway

The Norwegian Directorate of Fisheries organized exploratory fishery expeditions to Hatton Bank in 1991, 1998, 1999 and 2000. The discovery of good concentrations of Greenland Halibut increased the interest in this fishery and a commercial longline fishery was established in 2000. This fishery expanded in 2001 and during this year Møre Research organized a feasibility fishery, with three longliners and one trawler on Hatton Bank (Kjerstad *et al.* 2002). To collect fishery and biological data The Directorate of Fisheries hired Hareide Fishery Consultants to gather information and to carry out onboard sampling.

A comprehensive report from the exploratory fishery in 2001 was provided by Hareide *et al.* (WD 2002). Information on catch, effort, discarding, length distributions and other biological data is given.

In 2001 one trawler, 10 longliners and one gill-netter participated in deep-water fishery at Hatton Bank (including Edoras Bank, Fangorn Bank and George Bligh Bank) and the western slope of the Rockall Bank).

Trawl fishery

The trawler conducted two trips. Total fishing days for the trawler was 19 days.

The trawler conducted a fishery in depths from 500 to 1600 meters. The main target species were round-nose grenadier (*Coryphaenoides rupestris*), Greenland halibut (*Reinhardtius hippoglossoides*) and blue ling (*Molva dipterygia*).

Longline fishery

The longliners conducted a fishery in depths between 500 and 1600 meters. In the depth range 500 to 1100 meters the main target species were blue ling, tusk (*Brosme brosme*), mora (*Mora moro*), Portuguese dogfish (*Centroscyllium coelolepis*) and leafscale gulper shark (*Centrophorus squamosus*).

In depths between 1300 and 1600 meters the main target species was Greenland halibut. Bycatch species were rough-head grenadier (*Macrourus berglax*) and Portuguese dogfish.

Fishing in these two different depth ranges can be regarded as separate fisheries. The only overlapping commercial species is Portuguese dogfish.

The fishery for Greenland halibut is the first choice for the longliners. This species is distributed all along the western and northern slope of Hatton bank. In some areas it is found in high densities. Fishing on these concentrations gives high catch rates and profit. However, only 3-4 dense concentrations were discovered so far. The vessels which targeted Greenland Halibut spent many days searching before good concentrations were found. If they did not locate quantities of Greenland halibut they chose the second option in the shallower part of the slope. This fishery is far more predictable, but not as profitable as fishing on dense concentrations of Greenland halibut. On the other hand the catch rates of Greenland halibut drops quickly after 2-3 weeks of fishing.

Total number of fishing days for the longliners was 412. The longliners conducted 1-3 trips each. The effort in days, number of hooks and nets is given in in Hareide *et al.* (WD 2002).

Russian Federation

INTERNATIONAL WATERS AT THE LOUZY BANK (DIVISION V b)

In July 2001 RV "AtlantNIRO" conducted survey on the southern slopes of the Lauzy Bank outside the 200-mile limit in the depth interval from 550 to 1200 m. The purpose of this research was to collect data on the distribution of deep-sea species.

Rabbitfish (*Chimaera monstrosa*) occurred practically everywhere down to depth 700 m, the largest catch was fished in depth 600-700 m (density of fish concentrations to 10 t/mile²). The length of rabbitfish varied from 36 to 114 cm (Fig. 5), and averaged 83.4 cm. Sex ratio was close to 1:1. More than a half of all fish (50.5%) was mature. Minimal recorded length of mature fish was 78 cm. Rabbitfish fed poorly on benthic organisms (Ophiurae and Polychaetae).

Baird's smoothhead (*Alepocephalus bairdii*) was fished in depth more than 700 m. Its length was 23-74 cm, mean length of males was 45.2 cm, females 51.7 cm. The length of fish increased with depth of fishing. Weight of fish varied from 83 to 3030 g. Mean weight of males was 774 g, females 1169 g. Males were slightly more numerous than females (sex ratio 1.1:1). The majority of fish (81%) was mature. Smoothhead practically did not feed. Occasionally, worms and Ctenophora were found in stomachs.

ROCKALL BANK AND HATTON BANK (DIVISION VI b)

In February, June and July 2001 RV "AtlantNIRO" and RV "Atlantida" conducted a number of bottom trawl hauls in depth 770-1230 m on the Hatton Bank. In December a long-liner "Konstantin Konstantinov" surveyed the south-western and western slope of the bank in the depth interval of 280-1070 m

Rabbitfish (*Chimaera monstrosa*) was found in trawl catches from depth 390-1150 m. Its length varied from 60 to 105 cm, prevailing length - 75-90 cm, weight - from 1 to 3.5 kg.

Long-nosed chimaera (*Harriotta raleighana*) was found in trawl catches taken in depth 1050-1230 m. The length of fish varied from 75 to 110 cm.

Mora (*Mora moro*) occurred in long-line catches from depth 770-1070 m, with the largest quantity (up to 27% of catch) taken deeper than 1000 m. The length was 41-66 cm, mean length 53.7 cm. Females prevailed in number over males, sex ratio was 1:4. The vast majority of males (80.0%) and females (89.5%) had maturing gonads (stage 3), all the rest were either immature or in post-spawning condition.

NORWEGIAN SEA (DIVISIONS II a and II b)

In 2000-2001 some deep-sea species were fished as by-catch in the bottom fishery north of 70°N. Roughhead grenadier (*Macrourus berglax*) was most plentiful, with a major part of the catch taken by long-line.

Catches of roughhead grenadier were mainly discarded by longliners and trawlers and were as a rule not registered in vessels' daily reports. The grenadier were processed and frozen only onboard some vessels. As reported by research and exploratory fishing vessels this species was most numerous on the western slope of the Bear Island Bank, on the Kopytov Bank, in the area between Spitsbergen and the Bear Island at the depth of 500-800 m, where the catches by bottom longline reached 100-200 kg per 1.000 hooks. Catches at depths of 200-400 m did not exceed 20 kg per 1.000 hooks. In the bottom trawl catches the proportion of roughhead grenadier was small. It occurred mostly in Div. II b and its catch did not exceed 50 specimens per one trawling hour.

Trawl catches of roughheaded grenadier in Div. IIa consisted of specimens with the total length of 30-88 cm (45-50 cm predominantly). Larger specimens with total length of 37-88 cm (54-65 cm mainly) were caught by bottom longline. Females were larger than males. Mean weight constituted 1.5 kg, maximum weight – 5.5 kg. The majority of fish (66 %) was mature. In March, maturing specimens were predominantly caught; only some fishes were at the pre-spawning and post-spawning stage. In May, pre-spawning specimens were not caught. In catches taken by longline the number of females exceeded the number of males 2-2.5 times.

In Division II b roughheaded grenadier caught by bottom trawls had total length 28-89 cm (45-56 cm predominantly). Catches taken by bottom longline consisted of fish 43-85 cm long (55-70 cm mainly). Males predominated in number over females (1.7 – 2.8 times). In the bottom trawl catch the number of males and females was nearly the same. Immature fish constituted the main part of catches. The major part of mature specimens had maturing gonads. In April, a part of fish was at the pre-spawning stage. Grenadier fed moderately on ophiurans, gammarids, polychaetes and shrimp.

In the bottom trawl catch the proportion of grenadier was small, it occurred mostly in Div. II b, where its length was 19-78 cm. The mean length was 46.9 cm in May and 49.9 cm in November.

BARENTS SEA (SUB-AREA I)

During bottom trawl fishery roughheaded grenadier 50-75 cm long was by-caught sometimes. All the catch of grenadier was discarded.

18.2 Landings and biological information for other species

This section updates the biological information on individual species given in previous Study Group reports.

18.2.1 Roughhead grenadier (*Macrourus berglax*)

The landings of *Macrourus berglax* are given in Table 18.2.1.1.

Some information on catch rates in the Russian longline fisheries and size composition in the trawl fisheries in Sub-area II is given by Vinnichenko and Khlivnoy, 2001 WD.

Two papers on this species were presented at the NAFO Deep-sea Fisheries Symposium in 2001. Fossen et al. (2001) described the distribution and biology off east Greenland. Although not in the ICES area Murua (2001) described the biology and population structure in NAFO Divisions 3LMN.

Katsarou and Nævdal (2001) reported on population genetic studies of the roughhead grenadier *Macrourus berglax* L., in the North Atlantic Ocean.

18.2.2 *Mora moro* (Mora) and Moridae

The landings of Morid fishes are given in Table 18.2.2.1.

Some data on depth of occurrence, length range, sex ratio and maturity are given by Vinnichenko and Khlivnoy, 2001 WD.

The length frequency of *Mora moro* from an Irish longline survey in Sub-area VII in 2000 is given in Figure 18.2.2.2.

Aspects on the biology of *Lepidion eques* and *Antimora rostrata* in Icelandic waters have been described by Magnússon (2001).

18.2.3 Rabbit fish (*Chimaera monstrosa*)

The landings of *Chimaera monstrosa* are given Table 18.2.3.1. New data for the Danish fishery in Division IIIa has been included for 1992 to the present. A recent trend has been the landings of this previously discarded species by France, mainly in Sub-areas VI and VII.

A Russian survey on Lousy Bank (Division Vb) observed that *C. monstrosa* was widespread down to 700 m. The largest catch was fished in depth zone 600-700 m (density of fish concentrations to 10 t/nm²). Their length ranged from 36 to 114 cm (mean 83.4 cm). The sex ratio was close to 1:1 and 50.5% were mature. The minimum recorded length of mature fish was 78 cm. *C. monstrosa* fed on benthic organisms (Ophiuridae and Polychaetae). Depth and length range data are *C. monstrosa* and Long-nosed chimaera (*Harriota raleighana*) on the Rockall and Hatton Banks (Sub-area XII and Division VIb) are also provided in Vinnichenko and Khlivnoy, 2001 WD.

18.2.4 Baird's smoothhead (*Alepocephalus bairdii*)

The landings of *Alepocephalus bairdii* are given in Table 18.2.4.1. In recent years they are almost entirely by Spain from Sub-areas XII and VIb.

The deep-sea Spanish stern bottom freezer trawlers, worked in Hatton Bank for a total of 1363 days in the year 2000 and 1627 in the year 2001 (estimated days in the fishing ground), corresponding to 22202 and 26123 estimated hours

trawling, respectively. As in the previous years, the fishing operations were conducted at depths mainly between 800-1600m. Since 1998, there has been a gradual movement of the fishing effort into deeper water (Figure 18.2.4.1).

As in the previous years, roundnose grenadier (*Coryphaenoides rupestris*) (48%-45%) and Baird's smoothhead (*Alepocephalus bairdii*) (36%-35%) comprised the bulk of the catches. There was a high degree of retention of smoothheads (92%-97%), related to the commercial interest of this species for the Spanish freezer fleet. The estimated CPUE (kg/hr) for *Alepocephalus bairdii* on the Hatton Bank was 251 and 319 for 2000 and 2001 respectively.

The length frequency distribution of *Alepocephalus bairdii* from Spanish catches in ICES Division VIb and Sub-area XII in 2000 and 2001 is shown in Figure 18.2.4.2. The corresponding length frequency of the discards is given in Figure 18.2.4.3.

In a Russian survey on the Lousy bank (Division VIb) *Alepocephalus bairdii* occurred at depths > 700 m. The length range was 23-74 cm (mean length of males was 45.2 cm and of females 51.7 cm). There was an increase in fish size with depth. Data on weight, sex ratio and feeding are also given in Vinnichenko and Khlivnoy, 2001 WD

18.2.5 Wreckfish (*Polyprion americanum*)

The landings of *Polyprion americanum* are given in Table 18.2.5.1.

Some new data on the genetics of *P. americanum* in the North Atlantic is given by Ball et al., (2000) and Sedberry et al., (1999).

18.2.6 Bluemouth (*Helicolenus dactylopterus*)

The landings of *Helicolenus dactylopterus* for 1999 to 2001 are given in Table 18.2.6.1

No Irish data are included because they are not separable in the landings from other Sebastid or Scorpaenid fishes.

In ICES Sub-areas VI and VII *Helicolenus dactylopterus* first matures at around three or four years and spawns from March to June (Allain, 1998). In the Azores Sub-area X the catches of *Helicolenus dactylopterus* increased from less than 100 t at the beginning of the 1980s and reached a maximum in 1994 with 698 t. From 1995 to the present the catches have consistently decreased reaching about 340 t in 1999. *Helicolenus dactylopterus* are mainly caught by the demersal Azorean longliners. Because it is a multispecies fishery, which is mainly directed toward the *Pagellus bogaraveo*, there are no data available on the commercial CPUE. Survey CPUE's are available since 1995 and there is a general decreasing trend in the abundance of *H. dactylopterus* that seems to be comparable to the decreasing catch trends (Figure 18.2.6.1). *H. dactylopterus* is included in the landings sampling program of the Azores. Length compositions from cruise surveys area available for 1995, 1996 and 1997 (Figure 18.2.6.2). There were no major differences between years.

18.2.7 Silver scabbard fish (*Lepidopus caudatus*)

The landings of *Lepidopus caudatus* are given in Table 18.2.7.1. There has been a marked decline in the Portuguese landings of the species both in Sub-areas IX since 2000 and in Sub-area and X since 1999.

No new biological information was available.

18.2.8 Deep-water cardinal fish (*Epigonus telescopus*)

The landings of *Epigonus telescopus* for the years 1999 to 2001 are given in Table 18.2.8.1. The landings of *Epigonus telescopus* are mostly by France from Sub-areas VI and VII.

No new biological data were available.

Table 18.2.1.1

Working Group estimates of landings (tonnes)

ROUGHHEAD GRENADIER (*Macrourus berglax*) I and II

Year	Germany	Norway	Russia	TOTAL
1988				
1989				
1990	9	580		589
1991		829		829
1992		424		424
1993		136		136
1994				
1995				
1996				
1997		17		17
1998		55		55
1999				
2000		35	13	48
2001		74	20	94

ROUGHHEAD GRENADIER (*Macrourus berglax*) III and IV

Year	France	Ireland	Norway	Scotland	TOTAL
1988					
1989					
1990					
1991					
1992				7	7
1993					
1994					
1995					
1996					
1997		36			36
1998					
1999					
2000			1	3+	4
2001		1	1	9	11

ROUGHHEAD GRENADIER (*Macrourus berglax*) Va

Year	Iceland	TOTAL
1988		
1989		
1990		
1991		
1992		
1993		
1994		
1995		
1996	15	15
1997	4	4
1998	1	1
1999		
2000	5	5
2001		

ROUGHHEAD GRENADIER (*Macrourus berglax*) Vb

Year	France	Norway	TOTAL
1988			
1989			
1990			
1991			
1992			
1993			
1994			
1995			
1996			
1997			
1998	9		9
1999	58		58
2000	1		1
2001	2	2	4

ROUGHHEAD GRENADIER (*Macrourus berglax*) VI and VII

Year	EWN France	Norway	Scotland	TOTAL
1988				
1989				
1990				
1991				
1992				
1993	18			18
1994	5			5
1995	2			2
1996				
1997				
1998				
1999		34		34
2000	+	1	8	9
2001		1		28

ROUGHHEAD GRENADIER (*Macrourus berglax*) X

Country	France	TOTAL
1988		
1989		
1990		
1991		
1992		
1993		
1994		
1995		
1996		
1997		
1998		
1999	3	3
2000		
2001		

ROUGHHEAD GRENADIER (*Macrourus berglax*) XII

Country	Norway	TOTAL
1988		
1989		
1990		
1991		
1992		
1993		
1994		
1995		
1996		
1997		
1998		
1999		
2000	7	7
2001	9	9

ROUGHHEAD GRENADIER (*Macrourus berglax*) XIV

Country	Greenland	Norway	TOTAL
1988			
1989			
1990			
1991			
1992			
1993	18	34	52
1994	5		5
1995	2		2
1996			
1997			
1998		6	6
1999		14	14
2000			
2001		26	26

Year	I and II	III and IV	Va	Vb	VI and VII	X	XII	XIV	TOTAL
1988									
1989									
1990		589							589
1991		829							829
1992		424	7						431
1993		136				18		52	206
1994						5		5	10
1995						2		2	4
1996				15					15
1997		17	36	4					57
1998		55			9			6	70
1999					58	34	3	14	109
2000		48	4	4	1	9		7	73
2001		94	11		4	28		9	172

Table 18.2.2.1 Working Group estimates of landings (tonnes).

MORIDAE Vb

Year	Norway	France	TOTAL
1988			
1989			
1990			
1991	5		5
1992			
1993			
1994			
1995			
1996			
1997			
1998			
1999			
2000		+	
2001			

MORIDAE VI and VII

Year	UK (E+W)	France	Ireland	UK (Scot) (1)	Norway	TOTAL
1988						
1989						
1990						
1991					1	1
1992					25	25
1993						
1994						
1995						
1996						
1997						
1998						
1999			12		8	20
2000		3	59	39	6	104
2001			70	25		95

(1) Included with Phycis blennoides

MORIDAE VIII and IX

Year	France	Spain	TOTAL
1988			
1989			
1990			
1991			
1992			
1993			
1994			
1995		83	83
1996		52	52
1997		88	88
1998			
1999			
2000	5	15	20
2001	2	16	18

MORIDAE X

Year	Portugal	TOTAL
1988	18	18
1989	17	17
1990	23	23
1991	36	36
1992	31	31
1993	33	33
1994	42	42
1995		
1996		
1997		
1998		
1999		
2000		
2001		

MORIDAE XII

Year	France	Spain	TOTAL
1988			
1989			
1990			
1991			
1992			
1993			
1994			
1995			
1996			
1997			
1998			
1999			
2000	+	1	1
2001	+		

Year	Vb	VI and VII	VII and IX	X	XII	TOTAL
1988				18		18
1989				17		17
1990				23		23
1991	5		1	36		42
1992			25	31		56
1993				33		33
1994				42		42
1995			83			83
1996			52			52
1997			88			88
1998						0
1999	1		20			21
2000			104		1	125
2001			95			113

Table 18.2.3.1 Working Group estimates of landings (tonnes).

RABBIT FISH (*Chimaera monstrosa*) II

Year	France	TOTAL
1988		
1989		
1990		
1991		
1992		
1993		
1994		
1995		
1996		
1997		
1998		
1999	1	1
2000	6	6
2001	5	5

RABBIT FISH (*Chimaera monstrosa*) III/IV

Year	Denmark	France	Scotland	TOTAL
1988				
1989				
1990				
1991				
1992		122		
1993		8		
1994		167		
1995				
1996		14		
1997		38		
1998		56		
1999	45		+	
2000	17		15	15
2001		10	10	10

RABBIT FISH (*Chimaera monstrosa*) Va

Year	Iceland	TOTAL
1988		0
1989		0
1990		0
1991	499	499
1992	106	106
1993	3	3
1994	60	60
1995	106	106
1996	21	21
1997	15	15
1998	29	29
1999	2	2
2000	5	5
2001		

RABBIT FISH (*Chimaera monstrosa*) Vb

Year	Faroes	France	Scotand	TOTAL
1988				
1989				
1990				
1991				
1992				
1993				
1994				
1995	1			1
1996	0			
1997	0			
1998				
1999		3	+	3
2000		54		54
2001		82		82

RABBIT FISH (*Chimaera monstrosa*) VI and VII

Year	EWI	France	Ireland	Scotland	Spain	TOTAL	
1988							
1989							
1990							
1991							
1992							
1993							
1994			2			2	
1995							
1996							
1997							
1998							
1999			235		1	236	
2000		3	347	3	+	2	355
2001			622	13		6	641

RABBIT FISH (*Chimaera monstrosa*) VIII

Year	France	TOTAL
1988		
1989		
1990		
1991		
1992		
1993		
1994		
1995		
1996		
1997		
1998		
1999	2	2
2000	2	2
2001	7	7

RABBIT FISH (*Chimaera monstrosa*) XII

Year	Spain	France	Ireland	TOTAL
1988				0
1989				0
1990				0
1991				0
1992				0
1993				0
1994				0
1995				0
1996				0
1997	32			32
1998	42			42
1999	114		1	115
2000	46		2	48
2001	61		1	63

Year	II	III/IV	Va	Vb	VI/VII	VIII	XII	TOTAL
1988			0				0	0
1989			0				0	0
1990			0				0	0
1991			499				0	499
1992			106				0	106
1993			3				0	3
1994			60		2		0	62
1995			106	1			0	107
1996			21				0	21
1997			15				32	47
1998							42	42
1999	1		2	3	236	2	115	359
2000	6	15	4	54	355	2	48	484
2001	5	10		82	641	7	63	808

Table 18.2.4.1 Working Group estimates of landings (tonnes).
Updated from SGDEEP 2000

SMOOTHHEAD (*Alepocephalus* spp.) Va

Year	Iceland	TOTAL
1988		
1989		
1990		
1991		
1992	10	10
1993	3	3
1994	1	1
1995	1	1
1996		
1997	+	
1998		
1999		
2000		
2001		

SMOOTHHEAD (*Alepocephalus* spp.) XII

Year	Spain	TOTAL
1988		
1989		
1990		
1991		
1992		
1993		
1994		
1995		
1996	230	230
1997	3692	3692
1999	4643	4643
1999	6549	6549
2000	978	978
2001	3902	3902

SMOOTHHEAD (*Alepocephalus* spp.) XIV

Year	Germany	Spain	TOTAL	
1988				
1989				
1990				
1991				
1992				
1993				
1994				
1995				
1996				
1997				
1999				
1999				
2000		12	4146	4158
2001			4121	4121

Year	Va	XII	XIV	TOTAL
1988				
1989				
1990				
1991				
1992	10			10
1993	3			3
1994	1			1
1995	1			1
1996		230		230
1997		3692		3692
1999		4643		4643
1999		6549		6549
2000		978	4158	5136
2001		3902	4121	8023

Table 18.2.5.1 Working Group estimates of landings (tonnes).

WRECKFISH (*Polyprion americanus*) VI and VII

Year	France	Ireland	Spain	TOTAL
1988		7		7
1989				
1990		2		2
1991		10		10
1992		15		15
1993		0		
1994				
1995				
1996		4	79	83
1997				
1998			12	12
1999		9	5	14
2000		13	1	14
2001		15	1	17

WRECKFISH (*Polyprion americanus*) VIII and IX

Year	France	Portugal	Spain	UK (EW)	TOTAL
1988	1	188	9		198
1989	1	283			284
1990	2	161			163
1991	3	191			194
1992	1	268			269
1993		338			338
1994		406	3		409
1995		372	19	2	393
1996	3	214	69	8	294
1997		170	44		214
1998		164	63		227
1999	7	137	7		151
2000	12	72	37		121
2001	3	77	85		165

WRECKFISH (*Polyprion americanus*) X

Year	France	Portugal	Norway	TOTAL
1988		191		191
1989		235		235
1990		224		224
1991		170		170
1992	3	234		237
1993		308	3	311
1994		428		428
1995		240		240
1996		240		240
1997		177		177
1998		139		139
1999		133		133
2000		268		268
2001		232		232

ALL AREAS	VI and VII	VIII and IX	X	TOTAL
1988	7	198	191	396
1989		284	235	519
1990	2	163	224	389
1991	10	194	170	374
1992	15	269	237	521
1993		338	311	649
1994	0	409	428	837
1995	0	393	240	633
1996	83	294	240	617
1997	0	214	177	391
1998	12	227	139	378
1999	14	151	133	298
2000	14	121	268	403
2001	17	165	232	414

Table 18.2.6.1 Working Group estimates of landings (tonnes)BLUEMOUTH (*Helicolenus dactylopterus*) III/IV

Year	UK (EW)	UK (SCO)	TOTAL
1999	5+		5
2000	+		
2001			

BLUEMOUTH (*Helicolenus dactylopterus*) Vb

Year	UK (EW)	UK (SCO)	TOTAL
1999	58+		58
2000	16		16
2001			

BLUEMOUTH (*Helicolenus dactylopterus*) VI

Year	France	Spain	UK (EW)	UK (SCO)	TOTAL
1999	57	91		58	206
2000	37	64	28	85	214
2001	37	9	8		54

BLUEMOUTH (*Helicolenus dactylopterus*) VII

Year	France	UK (EW)	UK (SCO)	Spain	TOTAL
1999	66	112		19+	197
2000	61	49		18+	128
2001	37	46		+	83

BLUEMOUTH (*Helicolenus dactylopterus*) VIII and IX

Year	France	Portugal	Spain	TOTAL
1999	7	15	9	31
2000	17	12	7	36
2001	5	22	7	34

BLUEMOUTH (*Helicolenus dactylopterus*) X

Year	Portugal	TOTAL
1999	320	320
2000	452	452
2001	301	301

All areas:

Year	III and IV	Vb	VI	VII	VIII and IX	X	TOTAL
1999	5	58	206	197	31	320	817
2000		16	214	128	36	452	846
2001			54	83	34	301	472

Table 18.2.7.1

Working Group estimates of landings (tonnes).

SILVER SCABBARDFISH (*Lepidopus caudatus*) VI and VII

Year	EWN	France	Germany	Scotland	TOTAL
1988					
1989					
1990					
1991					
1992					
1993				2	2
1994					
1995					
1996					
1997					
1998					
1999		18			18
2000	+		3	12	15
2001					

SILVER SCABBARDFISH (*Lepidopus caudatus*) VIII and IX

Year	France	Portugal	Spain	Russia/USSR	TOTAL
1988		2666			2666
1989		1385			1385
1990		547		37	584
1991		808			808
1992		1264		110	1374
1993		2397			2397
1994		1054			1054
1995		5672			5672
1996		1237			1237
1997		1725			1725
1998		966			966
1999		2	3067	1584	4653
2000		1	15	14	30
2001		2	22		24

SILVER SCABBARDFISH (*Lepidopus caudatus*) X

Year	Latvia	Portugal	TOTAL
1988		70	70
1989		91	91
1990		120	120
1991		166	166
1992	1905	255	2160
1993	1458	264	1722
1994		373	373
1995	8	781	789
1996		815	815
1997		1115	1115
1998		1186	1186
1999		86	86
2000		28	28
2001		14	14

SILVER SCABBARD FISH (*Lepidopus caudatus*) XII

Country	Russia/USSR	TOTAL
1988		
1989	102	102
1990	20	20
1991		
1992		
1993	19	19
1994		
1995		
1996		
1997*		
1998		
1999		
2000		
2001		

ALL AREAS

	VI and VII	VIII and IX	X	XII	TOTAL
1988		2666	70		2736
1989		1385	91	102	1578
1990		584	120	20	724
1991		808	166		974
1992		1374	2160		3534
1993	2	2397	1722	19	4140
1994		1054	373		1427
1995		5672	789		6461
1996		1237	815		2052
1997		1725	1115		2840
1998		966	1186		2152
1999	18	4653	86		4757
2000	15	30	28		73
2001		24	14		38

Table 18.2.8.1 Working Group estimates of landings (tonnes)

DEEP-WATER CARDINAL FISH (*Epigonus telescopus*) Vb

Year	France	TOTAL
1999	8	8
2000	2	2
2001	6	6

DEEP-WATER CARDINAL FISH (*Epigonus telescopus*) VI

Year	France	Ireland	UK (SCO)	TOTAL
1999	54			54
2000	60	1+		61
2001	58	10		68

DEEP-WATER CARDINAL FISH (*Epigonus telescopus*) VII

Year	France	Faroes	Ireland	TOTAL
1999	221		4	225
2000	178		2	180
2001	74		207	281

DEEP-WATER CARDINAL FISH (*Epigonus telescopus*) VIII and IX

Year	France	Portugal	TOTAL
1999			3
2000	2	3	5
2001		3	3

DEEP-WATER CARDINAL FISH (*Epigonus telescopus*) X

Year	France	TOTAL
1999		
2000	3	3
2001		

All areas:

Year	Vb	VI	VII	VIII and IX	X	TOTAL
1999	8	54	225	3		290
2000	2	61	180	5	3	251
2001	6	68	281	3		358

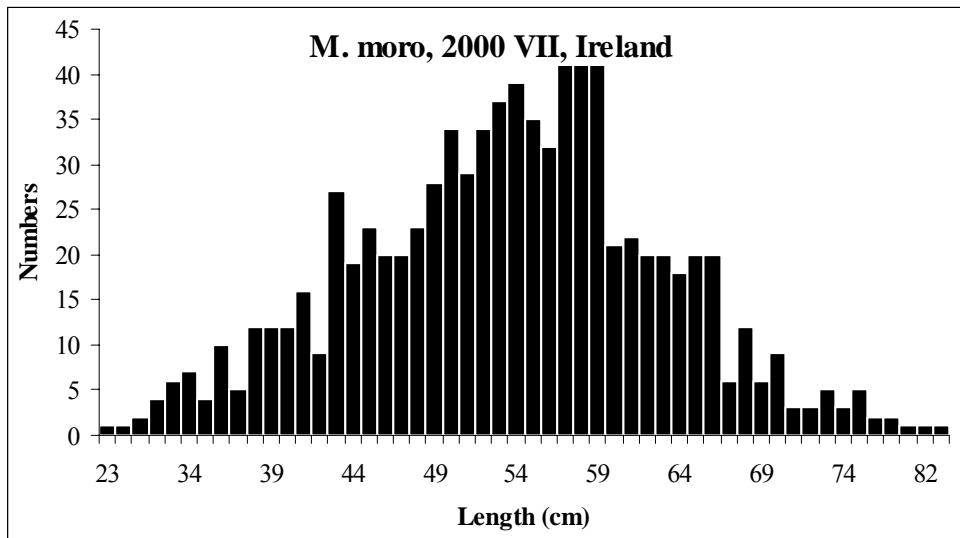

Figure 18.2.4.1.- Estimated fishing effort (hours trawling) by year and depth. Spanish deep-sea fishery at Hatton Bank (Year 2001 preliminary).

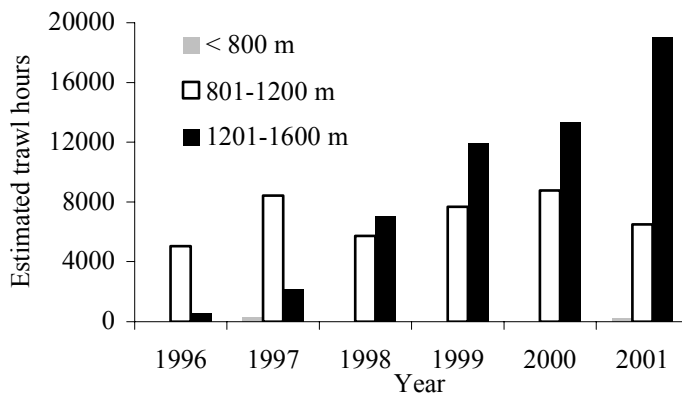

Figure 18.2.2.2 The length frequency of *Mora moro* in Sub-area VII from Irish longline surveys.

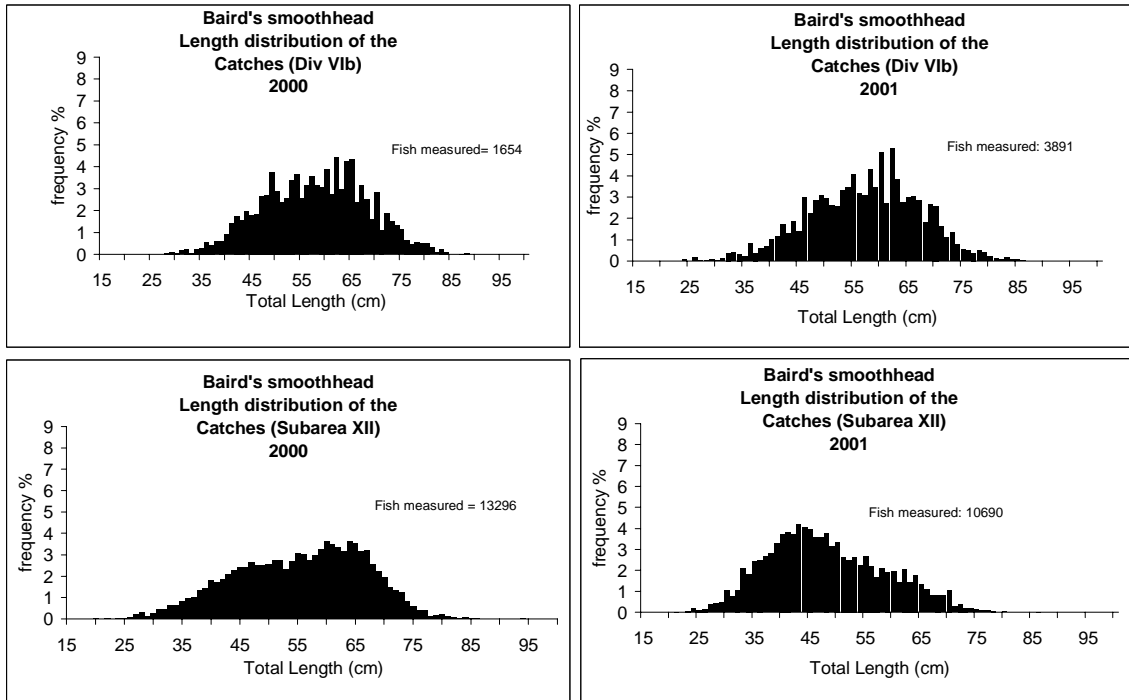

Figure 18.2.4.2 Length frequency distributions of *Alepocephalus bairdii* catches

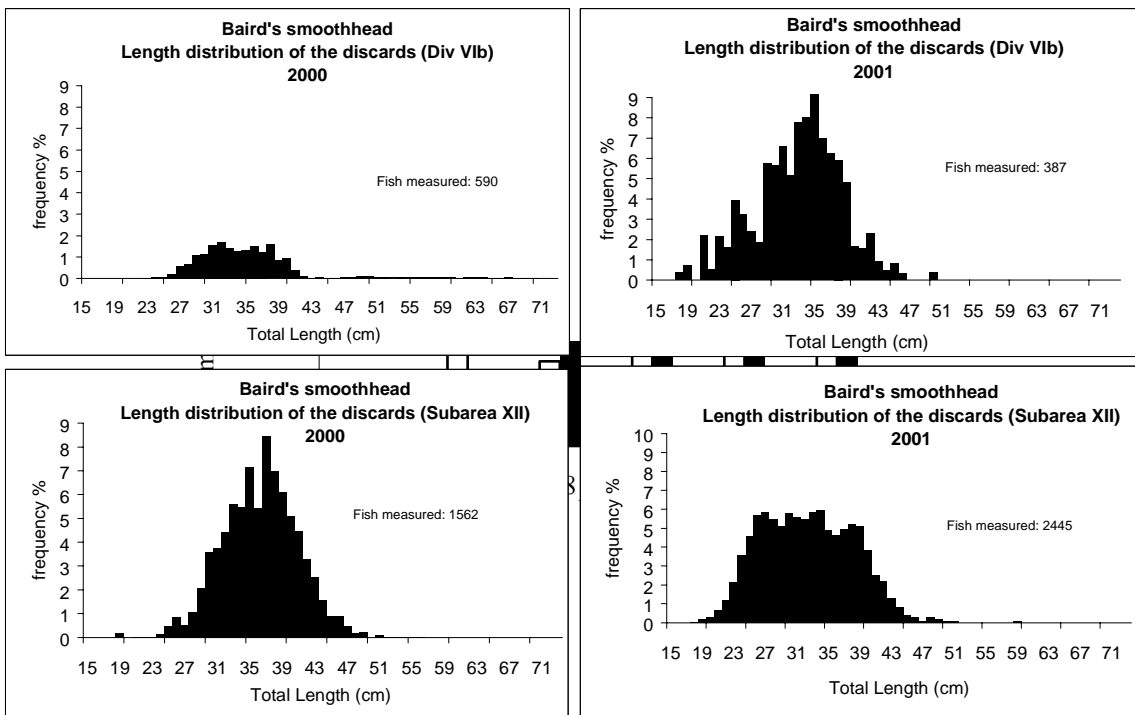

Figure 18.2.4.3 Length frequency distributions of the discarded *Alepocephalus bairdii*

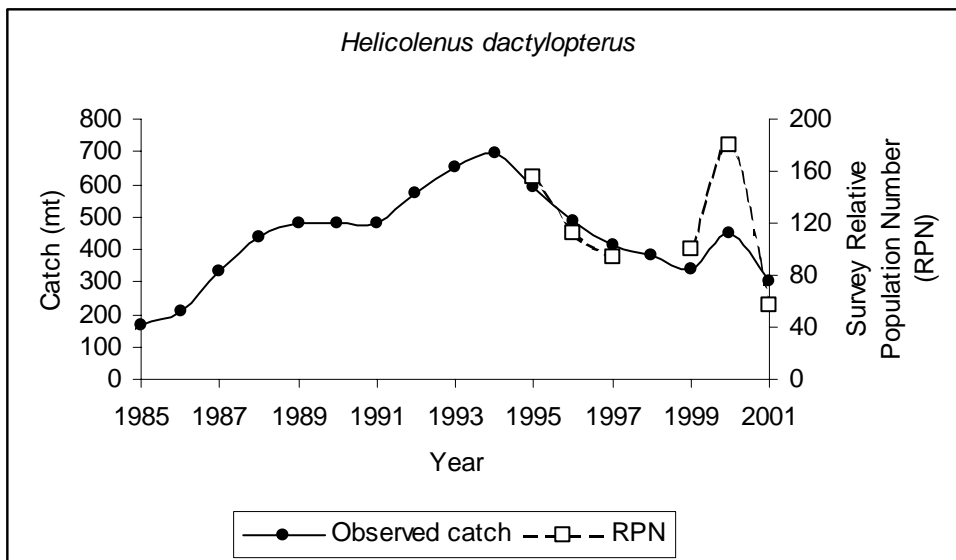

Figure 18.2.6.1 Commercial catch from Azorean demersal fishery and survey abundance from area X for *Helicolenus dactylopterus*.

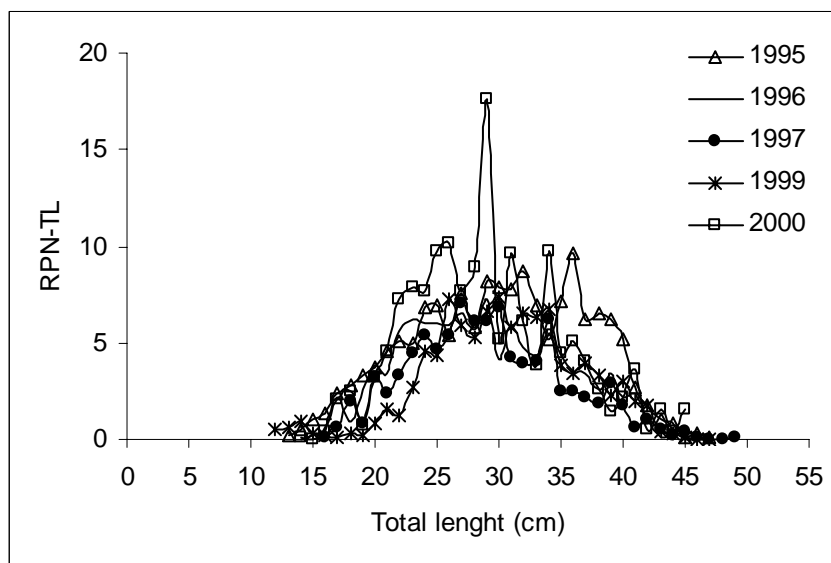

Figure 18.2.6.2. Length composition of *Helicolenus dactylopterus* from Azorean longline survey (Area X).

19 RECOMMENDATIONS

- 1) The Working Group remains concerned that the landings statistics as presented may not reflect the true scale of the recent fishing activity in waters outside the national EEZs. The Working group recommends that member states should be encouraged to collect area-specific catch, landings, effort and biological data from exploratory and commercial fishing activities in international waters and report it to ICES. Any documented information that member states may have on fishing activity from non-member states in these waters should also be reported to ICES.
- 2) The catch and effort assessment methods used by the Working Group suggest that time series of effort and CPUE may be particularly valuable for the assessment of deep-water species. The present assessment of the status of stocks and reference points were almost entirely derived from CPUE analyses. Only in a few cases can it be anticipated that analytical assessments may become possible. It caused concern in the Working Group that CPUE series for several species, notably ling, blue ling and tusk in many fishing areas, could not be updated. The Working Group recommends that member states maintain and refine long-term data series on catch and effort and where possible collate historical data.
- 3) For several species there is concern that catch rates can only be maintained by sequential depletion of relatively isolated concentrations/sub-units of a stock. The smallest unit for which data are reported at present is the ICES Sub-areas and Divisions, and this spatial resolution may not be appropriate for monitoring this type of fishing activity. The depth range within an area may be very wide, and the sizes of the areas are very different. It is therefore recommended that systems are developed and implemented for recording effort and catches at a finer temporal and geographical scale.
- 4) Most stocks that have been reviewed by the Working Group and upon which assessments have been attempted have used surplus production (biomass dynamic) models as the main assessment tool. As a precursor to data analysis by these models there has been standardisation of the input CPUE indices accounting for such things as month and area effects using multiplicative regression analyses. However, the results of these analyses have not been available to the Working Group for examination. It is recommended that at future meetings of the Working Group the results of such analyses including diagnostics be provided to allow for an evaluation of the reliability and variability of the resultant indices before conducting the assessments.
- 5) The Working Group recommends that all available ageing data for blue ling be collated and reviewed with the aim of attempting age-based assessments before the next Working Group. The Working Group also recommends that available data on the spatial and seasonal distribution of spawning concentrations be collated, with a view to providing this information to managers and identifying future research needs such as egg distribution surveys.
- 6) Black scabbardfish is widely distributed in the NE Atlantic. Although the knowledge on the biology of this species has increased in recent years, information on its spatial and seasonal distribution is still very limited and uncertain. Modelling the actual state of species exploitation is severely impaired by the lack of relevant data. Nevertheless, as a consequence of the uncontrolled increase in fishing pressure on this species, the need for improved scientific advice is increasing. Therefore, it is strongly recommended to pursue scientific investigations of this species related to fisheries management, particularly through a detailed analysis of historical and recent data in a spatial context.
- 7) An age-based assessment for *Pagellus* in Subarea X was attempted for the first time at the 2002 meeting. Although the results were not acceptable for detailed presentation the Working Group agreed that there is considerable merit in pursuing an age-based assessment for this stock when time is available to reflect on better formulations of the assessment model. These should be based on what is known about the main characteristics of the stock such as its biological features (growth and maturity), distribution and migration patterns as well as fishing strategies that are important in assessing it more accurately. It is recommended therefore that assessment work be carried out intersessionally using age based methods with due consideration to the above and the results presented to the next meeting of the Working Group.
- 8) The Working Group was informed that assessments of deepwater stocks may be enhanced in many cases by applying stock reduction models where suitable data are available. It was noted that such models have been applied successfully in South Pacific deepwater stocks in the Australia and New Zealand areas. It is recommended therefore that attempts are made at applying stock reduction models to deepwater stocks in the ICES area intersessionally and the results be presented at the next meeting of the Working Group.
- 9) Considerable progress has been made on ageing methodologies and collection of length-at-age data for many species (Gordon, 1999; Magnusson et al. 1997). In view of the low level of deepwater ageing since the end of these studies, the Working Group recommends that countries' research institutes co-operate closely in the co-ordination of future ageing studies of species/stock units.
- 10) The Working Group continues to encourage discard sampling and recommends a standard discard-reporting format to allow for uniform incorporation of available data in future assessments. WGDEEP should communicate with the Study Group on Discarding to further this process.

- 11) The Working Group recommends that countries continue their efforts to collect landings and effort data for sharks at species level. In view of the lack of CPUE time series suitable for assessments, the Working Group would encourage the development and refinement of life history models for deepwater sharks.

20 REFERENCES AND WORKING DOCUMENTS

20.1 References

Agnew, D. J., C. P. Nolan, J. R. Beddington and R. Baranowski. 2000. Approaches to the assessment and management of multispecies skate and ray fisheries using the Falkland Islands fishery as an example. *Can. J. Fish. Aquat. Sci.* 57: 429-440.

Allain, V. 1998. Reproduction and fecundity of 3 species of deep-sea fish from the north-east Atlantic Ocean. *ICES CM*. CM 1998/O:4:14pp.

Allain, V. 1999. *Ecologie, biologie et exploitation des populations de poissons profonds de l'Atlantique du nord-est. Océanologie Biologique*. Brest, Université de Bretagne Occidentale: 376.

Allain, V. and Lorance P. 2000. "Age estimation and growth of some deep-sea fish from the Northeast Atlantic ocean." *Cybium* 24(3 suppl.): 7-16.

Allain, V. 2001. "Reproductive strategies of three deep-water benthopelagic fishes from the northeast Atlantic Ocean." *Fisheries Research* 51(2-3): 165-176.

Annala, J. H. 1993. Report from the Fishery assessment plenary, May 1993: stock assessments and yield estimates. Wellington, NIWA: 241.

Annala, J. H. and Sullivan K. J. 1996. Report from the Fishery assessment plenary,

April-May 1996: stock assessments and yield estimates. Wellington, NIWA: 308.

Anon. 2000. Final report of the EU Study Project CT 97/0084. Environment and biology of deep-water species *Aphanopus carbo* in the NE Atlantic: Basis for it's management (BASBLACK). DG XIV European Commission, 94 p.

Azevedo, M. and Cadima, E. 2002. Stock conservation properties of $F_{0.1}$, Working Document presented to the ICES SGPA, 4-8 March 2002, 5 p.

Ball, A.O., G.R. Sedberry, M.S. Zetcoff, R.W. Chapman, and J.L. Carlin. 2000. Population structure of the wreckfish *Polyprion americanus* determined with microsatellite genetic markers. *Marine Biology*. 137:1077-1090.

Basson, M., J. R. Beddington, J. A. Crombie, S.J. Holden, L. V. Purchase and G.A. Tingley. 1996. Assessment and management techniques for migratory annual squid stocks: the *Illex argentinus* fishery in the Southwest Atlantic as an example. *Fisheries Research* 28: 3-27.

Basson M., Gordon, J. D. M. Large, P. A. Lorance, P. Pope, J. G. and Rackham, B. 2001. The effects of fishing on deep-water fish species to the west of Britain. Final report to JNCC, F90-01-216, CEFAS, Lowestoft, 150 pp.

Beddington, J. R., A. A. Rosenberg, J. A. Crombie and G. P. Kirkwood. 1990. Stock assessment and the provision of management advice for the short fin squid fishery in Falkland Island waters. *Fish. Res.* 8: 351-365.

Bergstad, O. A. 1990. Distribution, population structure, growth and reproduction of the roundnose grenadier *Coryphaenoides rupestris* (Pisces: Macrouridae) in the deep waters of the Skagerrak. *Marine Biology* 107: 25-39.

Bergstad, O. A. 1993. Distribution, population structure, growth, and reproduction of the greater silver smelt, *Argentina silus* (Pisces, Argentinidae), of the Skagerrak and the north-eastern North Sea. *ICES Journal of Marine Science*, 50:129-143.

Bergstad, O.A. and Hareide, N.-R. 1996. Ling, blue ling and tusk of the North-East Atlantic. *Fisken og Havet* 1996,15: 126 p.

BIM, 2002a. Deepwater Programme 2001, Scientific Report to the ICES Working Group on the Biology and Assessment of Deep-Sea Fisheries Resources (WGDEEP). Dun Laoghaire: Irish Sea Fisheries Board. 19 pp.

- BIM, 2002b. Deepwater Programme 2001, Scientific Report to the ICES Working Group on the Biology and Assessment of Deep-Sea Fisheries Resources (WGDEEP) Appendix II: Commercial Species. Dun Laoghaire: Irish Sea Fisheries Board. 110 pp.
- BIM 2002c. Deepwater Programme 2001, Scientific Report to the ICES Working Group on the Biology and Assessment of Deep-Sea Fisheries Resources (WGDEEP). Appendix II: Discard Species. Dun Laoghaire: Irish Sea Fisheries Board. 88 pp.
- Blasdale, T. & Newton, A. W. 1998. Estimates of discards from two deep-water fleets in the Rockall Trough. ICES CM 1998/O:11.
- Bordalo-Machado, P., I. Figueiredo, S. Reis, D. Sena-Carvalho, T. Blasdale, A. Newton, L. S. Gordo, 2001. New Findings on the Reproductive Biology of the Black Scabbardfish (*Aphanopus carbo* Lowe, 1839) in the NE Atlantic. Deep-sea Fisheries Symposium, NAFO SCR Doc. 01/89.
- Branch, T.A. 2001 A review of orange roughy (*Hoplostethus atlanticus*) estimation methods, biology and stock structure. In: A decade of Namibian Fisheries Science. Payne, A.I.L, Pillar, S.C. and Crawford, R.J.M. (Eds.) South African Journal of Marine Science. 23: 181-203.
- Butterworth, D. S. and P. A. Andrew. 1984. Dynamic catch-effort models for the hake stocks in ICSEAF Divisions 1.3-2.2. Colln scient. Pap. Int. Commn. SE. Atl. Fish. 11: 29-58.
- Cadenat, J. and Blache, J. 1981. Requins de Mediterranee et d'Atlantique (plus particulierement de la Cote Occidentale d'Afrique). Paris: Orstom. Faune Tropicale, no.XXI.
- Casas, J. M. and C. Piñeiro, 2000. Growth and age estimation of greater forkbeard (*Phycis blennoides* Brünnich, 1768) in the north and west of the Iberian Peninsula (ICES Division VIIIc and IXa). Fisheries Research 47: 19-25.
- Clark, M. R., and King, K. J. 1989. Deepwater fish resources off the North Island, New Zealand: results of a trawl survey, May 1985 to June 1986. Wellington: Ministry of Agriculture and Fisheries. New Zealand Fisheries Technical Report, no. 11. 88 pp.
- Clarke, M.W. 2000. Aspects of the biology of three exploited deepwater sharks *Centrophorus squamosus*, *Centroscymnus coelolepis* and *Deania calceus* (Elasmobranchii, Squalidae) from the continental slopes of the Rockall Trough and Porcupine Bank. Dublin: National University of Ireland. *Unpublished Ph.D. Thesis*.
- Clarke, M.W., Connolly, P.L and Bracken, J.J. 2001. Biology of exploited deepwater sharks west of Ireland and Scotland. NAFO SCR Document. 19 pp.
- Clarke, M.W., Connolly, P.L. and Bracken, J.J. 2002a. Age estimation of the exploited deepwater shark *Centrophorus squamosus* from the continental slopes of the Rockall Trough and Porcupine Bank. *Journal of Fish Biology*, **60**: 501-514.
- Clarke, M.W., Connolly, P.L. and Bracken, J.J. 2002b. Catch, discarding, age estimation, growth and maturity of the squalid shark *Deania calceus* west and north of Ireland. *Fisheries Research*, *in press*.
- Clarke, M. W., Connolly, P. L., and Kelly, C. J. 1999. Preliminary Catch, Discards and Selectivity Results of Trawl Survey on Deepwater Slopes of the Rockall Trough. Dublin: Marine Institute. Fisheries Leaflet, no. 178.
- Clarke, M.W., Hareide, N.-R. and Hoey, S. 2002. Longline survey of slopes of Porcupine Bank. Marine Institute Fisheries Leaflet *in press*.
- Clarke, M.W. and Moore, S.J. 2002. Longline surveys on the Porcupine, Rockall and Hatton Banks. Marine Institute Fisheries Leaflet *in press*.
- Coggan, R.A. 1997. Designation of fishing areas in the North-east Atlantic for deep-water fisheries surveys. ICES CM 1997/Y:11, 4pp.

- Cohen, D.M., T. Inada, T. Iwamoto and N. Scialabra. 1990. Gadiformes fishes of the world (Order Gadiformes). An annotated and illustrated catalogue of cods, hakes, grenadiers and other gadiform fishes known to date. *FAO Fisheries Synopsis*, N 125, Vol. 10: 1-442.
- Collie, J. S. and M. P. Sissenwine. 1983. Estimating population size from relative abundance data measured with error. *Can. J. Fish. Aquat. Sci.* 40: 1871-1879.
- Connolly, P. L., and Kelly, C. J. 1996. Catch and discards from experimental trawl and longline fishing in the deep water of the Rockall trough. *Journal of Fish Biology*, **49** (Supplement A): 132-144.
- Connolly, P. L., and Kelly, C. J. 1997. Deep-water trawl and long-line surveys in 1995. Dublin: Roinn na Mara. Fisheries Leaflet, no. 173.
- Connolly, P. L., Kelly, C. J., and Clarke, M. W. 1999. Long-line Survey of the eastern slopes of the Rockall Trough. Dublin: Marine Institute. Fisheries Leaflet, no. 180.
- Conser, R. J. 1998. A fresh look at surplus production modelling as a pragmatic assessment tool. ICES CM 1998/BB:8.
- Conser, R. J., J. M. Porter and J.J. Hoey. 1992. Casting the Shepherd stock-production model in a statistical framework suitable for swordfish assessment and management advice. *Int. Comm. Conserv. Atlantic Tunas*, Coll. Vol. Sci. Pap. 39: 593-599.
- DE León, M.E., Malkov, A., 1979. Estudio preliminar de la edad y crecimiento del *Beryx splendens*, Lowe del Atlántico centro-occidental. *Rev. Cub. Inv. Pesq.* 4 (4): 62-72.
- DeLury, D. B. 1947. On the estimation of biological populations. *Biometrics*. 3: 145-167.
- Deriso, R. B. 1980. Harvesting strategies and parameter estimation for an age-structured model. *Can. J. Fish. Aquat. Sci.* 37: 268-282.
- Dobby, H. 2002. Stock assessment without age-structured data. Working Document for the ICES Working Group on the Biology and assessment of Deep-sea Fisheries Resources, 2002.
- Dupouy, H., Allain, V., Kergoat, B.. 1998. The discards of roundnose grenadier in the French Fishery in ICES subareas VI and VII. ICES C.M. 1998/O:20.
- Durán Muñoz, P. 2000. Results of a spring deep-sea exploratory fishing in North Atlantic in 2000. Working Document presented at 2000 ICES Working Group on the Biology and Assesment of Deep-Sea Fisheries Resources
- Durán Muñoz, P. 2001. Preliminary available information on the Spanish deep-water bottom trawl fishery on the Hatton Bank in 2000. 5 p.
- Durán Muñoz, P., E. Román and F.González. 2000. Results of a deep-water experimental fishing in the North Atlantic: An example of a Cooperative research initiative with the fishing industry. *ICES CM 2000/W: 04*.
- Durán Muñoz, P. and E. Román. 2001. The Spanish Multi-species Deep-sea Fishery at Hatton Bank (Northeast Atlantic): 1996-2000. NAFO SCR DOC No 120. Serial No N4508. 20 p.
- Ehrich, S. 1983. On the occurrence of some fish species at the slopes of the Rockall Trough. *Archiv für Fischereiwissenschaft*, **33**: 105-150.
- Estácio, Suzana, A. Mendonça, H. Krug, G. Menezes, and M. Pinho 2001. Aspects of the reproduction of six exploited demersal fish species in the Azores archipelago. Proceedings of the 3rd symposium of fauna and flora of the Atlantic islands. Arquipélago, Life and Marine Sciences. Supplement 2 – Part B: 83-94.
- Fletcher, R. I. 1982. A class of nonlinear productivity equations from fishery science and a new formulation. *Math. Biosci.* 61: 279-293.
- Fossen, I., O.A. Jørgensen, and A.C. Gundersen. 2001. Roughhead Grenadier (*Macrourus berglax*) in the waters off east Greenland: distribution and biology. *NAFO SCR Doc.* 01/145:12pp.

- Fox, W. W. 1970. An exponential yield model for optimizing exploited fish populations. *Trans. Amer. Fish. Soc.* 99: 80-88.
- Francis, R. I. C. C. 1992. Use of risk analysis to assess fishery management strategies: a case study using orange roughy (*Hoplostethus atlanticus*) on the Chatham Rise, New Zealand. *Can. J. Fish. Aquat. Sci.* 49: 922-930.
- Francis, R.I.C.C. 1993. Monte Carlo Evaluation of risks for biological reference points used in New Zealand fishery assessments. *Canadian Special Publication of Fisheries and Aquatic Sciences* 120: 221-230.
- Francis, R.I.C.C., Clark, M.R., Coburn, R.P., Field, K.D., Grimes, P.J. 1995. Assessment of the ORH 3B orange roughy fishery for the 1994-95 fishing year. New Zealand Fisheries Assessment Research Document 95/4. 43p. (Unpublished report held in NIWA library, Wellington).
- Francis, R. I. C. C. and P. L. Horn. 1997. Transition zone in otoliths of orange roughy (*Hoplostethus atlanticus*) and its relationship to the onset of maturity. *Marine Biology* 129: 681-687.
- Garrod, D. J. 1969. Empirical assessments of catch/effort relationships in North Atlantic cod stocks. *Int. Comm. NW Atl. Fish Res. Bull.* 6: 26-34.
- Gil, J., I. Sobrino and M. P. Jiménez 2000. A brief description of the Strait of Gibraltar red seabream (*Pagellus bogaraveo*) fishery. Working Document to the 2000 Report of the ICES S.G. on the Biology and Assessment of Deep-sea Fisheries Resources (SGDEEP).
- Gil, J. and I. Sobrino 2001. Studies on reproductive biology of the red (blackspot) seabream [*Pagellus bogaraveo* (Brünnich, 1768)] from the Strait of Gibraltar (ICES IXa/SW Spain). NAFO Scientific Council Symposium on Deep-Sea Fisheries, Varadero, Cuba. Poster Presentation #1.
- Girard, M. 2000. Distribution et reproduction de deux espèces de requins de grands fonds, les 'sikis', *Centrophorus squamosus* et *Centroscymnus coelolepis* exploitées dans l'Atlantique Nord-Est. Ph.D. thesis, L'Ecole Nationale Supérieure Agronomique de Rennes, Rennes, France.
- Girard, M. 2001. Distribution et reproduction des deux espèces des requins de grands fonds, *Centrophorus squamosus* and *Centroscymnus coelolepis* en Atlantique nord-est. *Bull. Soc. Zool. Fr.*
- Girard, M., and Du Buit, M. H. 1999. Reproductive biology of two deep-water sharks from the British Isles, *Centroscymnus coelolepis* and *Centrophorus squamosus*. *Journal of the Marine Biological Association of the U.K.*, 79: 923-931.
- Goodyear, C. P. 1999. A simulation model for Atlantic blue marlin and its application to test the robustness of stock assessments using ASPIC. *Col. Vol. Sci. Pap. ICCAT.* 49, 503-513.
- Gordon, J.D.M. 1979. The depth distribution of the roundnose grenadier (*Coryphaenoides rupestris* Gunnerus) on the west of Scotland slope. *Annales biologiques, Copenhagen*, 34 : 225-226.
- Gordon, J. D. M. (ed.). 1999. Final Consolidated Report of European Commission FAIR Contract 95 0655 Developing deep-water fisheries: data for the assessment of their interaction with and impact on a fragile environment, 1090 pp (also available as pdf file on www.sams.ac.uk)
- Gordon, J.D.M. 2001a. Deep-water fish and fisheries: Introduction. *Fisheries Research*, 51: 105-112
- Gordon, J.D.M. 2001b. Deep-water fisheries at the Atlantic Frontier. *Continental Shelf Research*, 21: 987-1003.
- Gordon, J. D. M. and J. E. Hunter (1994). Study of deep-water fish stocks to the west of Scotland. Oban, Scottish Association for Marine Science. 1: 141.
- Gordon, J. D. M. and S. C. Swan (1996). Validation of age readings from otoliths of juvenile roundnose grenadier, *Coryphaenoides rupestris*, a deep-water macrourid fish. *Journal of Fish Biology* 49(Supplement A): 289-297.
- Graham, M. 1935. Modern theory of exploiting a fishery and application to North Sea trawling. *J. Cons. Int. Explor. Mer.* 10: 264-274.

- Guellart, J. 1998. Contribucion al conocimiento de la biologia y la taxonomia del tiburón batial *Centrophorus granulosus* (Bloch y Schneider, 1801) (Elasmobranchii, Squalidae) en el mar Balear (Mediterraneo Occidental), Published Ph.D. Thesis. Valencia: Universitat de Valencia.
- Gueguen, J. 1974. Precisions sur les migrations de la Dorade Rose Pagellus bogaraveo (Brunnich 1768). Science et Peche, Bull. Inst.Peches Marit. n.237, juin 1974.
- Gulland, J. A. 1983. Fish Stock Assessment: A Manual of Basic Methods. Wiley, New York.
- Hall, N. G. and R. S. Brown. 1995. Delay-difference models for the western rock lobster (*Panulirus cygnus*) fishery of Western Australia. ICES mar. Sci. Symp. 199: 399-410.
- Hareide, N.-R. 2002. Results from Norwegian cruise surveys on the Mid-Atlantic Ridge. *Relatório da 18ª e 19ª Semana das Pescas dos Açores*, Horta, Portugal: 89-103pp.
- Heessen, H.J.L., and G.J. Rink. 2001. The fishery for greater argentine (*Argentina silus*) by the Netherlands. Poster presented to NAFO Deep-sea Fisheries Symposium, Cuba, September 2001.
- Hilborn, R. and C. J. Walters. 1992. Quantitative fisheries stock assessment: choice, dynamics and uncertainty. Chapman and Hall, London, UK.
- Hoarau, G & Borsa, P 2000 Extensive gene flow within sibling species in the deep-sea fish *Beryx splendens*. C.R. Aca. Sci. Paris, Sciences de la vie/Life sciences, 323: 315-325.
- Horn, P. L. and B. R. Massey, 1989. Biology and abundance of alfonsino and bluenose off the lower east coast North Island. *Report of the Ministry of Agriculture Food and Fisheries of New Zealand*, Wellington, 32.
- ICES, 1996. Report of the Study Group on the Biology and Assessment of Deep-sea Fisheries Resources. ICES C.M.1996/Assess:8.
- ICES, 1998. Report of the Study Group on the Biology and Assessment of Deep-sea Fisheries Resources. ICES C.M.1996/ACFM:12.
- ICES, 2000a. Report of the Study Group on the Biology and Assessment of Deep-sea Fisheries Resources. ICES C.M.2000/ACFM:8.
- ICES, 2000b. Report of the working group on the application of genetics in fisheries and mariculture. ICES CM 2000/F:03:, 53 pp.
- ICES, 2000c. Report of the ICES Advisory committee on Fishery Management, 2000. ICES Coop. Res. Rep. 242 (2)).
- ICES, 2001a. Report of the Working Group on the Biology and Assessment of Deep-sea Fisheries Resources. ICES CM 2000/ACFM:23.
- ICES, 2001b, Report of the ICES Advisory committee on Fishery Management, 2001. ICES Coop. Res.rep. 246(3), p. 625-641
- Isidro, E. J. 1996. Biology and population dynamics of selected demersal fish species of the Azores Archipelago. Thesis submitted in accordance with the requirements of the University of Liverpool for the degree of Doctor in Philosophy, Port Erin, Isle of Man. U.K., 249+xx pp.
- Jacobson, L. D, W. R. MacCallum and G. R. Spangler. 1987. Biomass dynamics of Lake Superior Lake Herring (*Coregonus artedii*): application of Schnute's difference model. Can. J. Fish. Aquat. Sci. 44: 275-288.
- Johannessen, A., and T. Monstad. 2001. Distribution, growth and exploitation of greater silver smelt (*Argentina silus*) (Ascanius) in Norwegian Waters 1980-1983. *NAFO SCR Doc.* 01/110:17pp.

- Johansen, T., Nedreaas, K. and Nævdal, G. 1993. Electrophoretic discrimination of blue mouth, *Helicolenus dactylopterus* (de la Roche, 1809), from *Sebastes* spp. in the Northeast Atlantic. *Sarsia*, 78: 25-29.
- Katsarou, E., and G. Nævdal. 2001. Population genetic studies of the roughhead grenadier *Macrourus berglax* L., in the North Atlantic Ocean. *Fisheries Research*. 51: 207-215.
- Kelly, C.J. 1997. Aspects of the biology of three deep water fish species from the continental slope of the Rockall Trough. Dublin: National University of Ireland. *Unpublished Ph.D. Thesis*.
- Kelly, C.J., Connolly, P.L. and Bracken, J.J. 1996. Maturity, oocyte dynamics and fecundity of the roundnose grenadier from the Rockall Trough. *Journal of Fish Biology*, 49 (Supplement A): 5-17.
- Kelly, C.J., Clarke, M. and Connolly, P.L. 1997. Catch and discards from a deep-water trawl survey in 1996. Marine Institute. Fishery Leaflet 175. Oct.1997.
- Kelly, C. J., P. L. Connolly, et al. 1997. Age estimation, growth, maturity and distribution of the roundnose grenadier from the Rockall Trough. *Journal of Fish Biology* 50: 1-17.
- Kimura, D.K. 1985. Changes to stock reduction analysis indicated by Schnute's general theory. *Canadian Journal of Fisheries and Aquatic Sciences*, vol. 42, no. 12, pp 2059-2060.
- Kimura, D.K. 1988. Stock-recruitment curves as used in the stock reduction analysis model. *J. CONS. CIEM.*, vol. 44, no. 3, pp 253-258.
- Kimura, D. K., J. W. Balsiger and D. H. Ito. 1984. Generalized stock reduction analysis. *Can. J. Fish Aquat. Sci.* 41: 1325-1333.
- Kimura, D. K., J. W. Balsiger and D. H. Ito. 1996. Kalman filtering the delay-difference equation: practical approaches and simulations. *Fishery Bulletin*. 94: 678-691.
- Kimura, D. K. and J. V. Tagart. 1982. Stock reduction analysis: another solution to the catch equations. *Can J. Fish. Aquat. Sci.* 39: 1467-1472.
- Kjerstad, M., Fjørtoft, K.L. and Fossen, I. 2002. Resultat frå garnfiske på Hatton bank 2001. Report from Møre Research no Å0201. 34 pp.
- Koslow, J. A., 1996. Energetic and life-history patterns of deep-sea benthic, benthopelagic and seamount-associated fish. *J. Fish Biol.*, 49 (Supplement A): 54-74.
- Kotlyar, A.N. 1987. Age and growth of alfonsino, *Beryx splendens*. *J. Ichthyol.* 27 (2): 104-111.
- Krug, H. 1990. The Azorean blackspot seabream, *Pagellus bogaraveo* (Brunnich, 1768) (Teleostei, Sparidae). Reproductive cycle, hermaphroditism, maturity and fecundity. *Cybium*, 14 (2): 151-159.
- Krug, H. 1998. Variation in reproductive cycle of the blackspot seabream, *Pagellus bogaraveo* (Brunnich, 1768) in the Azores. Arquipélago. *Life and Marine Sciences*. 16A: 37-47.
- Krug, H., Rosa, D., Menezes, G. M , Pinho, M. R. 1998. Age and growth of some demersal species of the Azores. ICES CM.1998/O:84 Poster
- Krug, H.M., A. Mendonça, M.E. Gouveia, M. Afonso Dias, J.M. Lorenzo, V. Rico & J. A. Quiles (submitted) Age and growth of the alfonsino *Beryx decadactylus* (Cuvier, 1829) from the Macaronesian archipelagos. *Bulletin of Marine Science*.
- Lehodey, P., Grandperrin, R., 1996. Age and growth of the alfonsino *Beryx splendens* over the seamounts off New Caledonia. *Mar. Biol.* 125: 249-258.
- Lehodey, P., R. Grandperrin, P. Marchal, 1997. Reproductive biology and ecology of a deep-demersal fish, alfonsino *Beryx splendens*, over the seamounts off New Caledonia. *Mar. Biol.* 128: 17-27.

- Leslie, P. H. and D. H. S. Davis. 1939. An attempt to determine the absolute number of rats on a given area. *J. Anim. Ecol.* 8: 94-113.
- Lleonart, J., J. Salat and B. Roel. 1985. A dynamic production model. *Colln. Scient. Pap. Int. Commn. SE. Atl. Fish.* 12: 119-146.
- Lorance, P. and H. Dupouy (2001). CPUE abundance indices of the main target species of the French deep-water fishery in ICES Sub-areas V-VII. *Fisheries Research* 51(2-3): 137-149.
- Lorance, P., H. Dupouy H., Allain V., (2001a). Assessment of the roundnose grenadier (*Coryphaenoides rupestris*) stock in the Rockall Trough and neighbouring areas (ICES Sub-areas V-VII). *Fisheries Research* 51(2-3): 151-163.
- Lorance, P., Garren F., Vigneau J., (2001b). Age estimations of the roundnose grenadier (*Coryphaenoides rupestris*), effects of uncertainties on ages. NAFO SCR doc.01/123, 15pp.
- Machado, P., and Figueiredo, I. 2000. A technique for ageing the birdbeak dogfish (*Deania calcea*, Lowe, 1839) from dorsal spines. *Fisheries Research*, 45: 93-98.
- Magnússon, J. V. 1988. On silver smelt (*Argentina silus* Asc.) in Icelandic waters. ICES C.M. 1988/G:39, 12 p.
- Magnússon, J.V. 2001. Distribution and some other biological parameters of two morid species *Lepidion eques* (Günther, 1887) and *Antimora rostrata* (Günther, 1878) in Icelandic waters. *Fisheries Research*. 51:267-281.
- Magnússon, J.V.; O.A.Bergstad; N.-R. Hareide; J. Magnússon; J. Reinert (1997). Ling, Blue Ling and Tusk of the Northeast Atlantic. Nordic Council of Ministers. *TemaNord* 1997:535.58 pp.
- Massey, B.R., Horn, P.L., 1990. Growth and age structure of alfonsino (*Beryx splendens*) from the lower east coast, North Island, New Zealand. *N.Z. J. Mar. Fresw. Res.* 24 : 121-136.
- McAllister, M. K. and G. P. Kirkwood. 1998a. Bayesian stock assessment: a review and example application using the logistic model. *ICES J. Mar. Sci.* 55: 1031-1060.
- McAllister, M. K., E. K. Pikitch, A. E. Punt and R. Hilborn. 1994. A Bayesian approach to stock assessment and harvest decisions using the sampling/importance re-sampling algorithm. *Can. J. Fish. Aquat. Sci.* 51: 2673-2687.
- Menezes, G. M., J. Delgado, H. Krug, M. R. Pinho, H. M. Silva, D. Carvalho, 1999. Design Optimization and Implementation of demersal Cruise Surveys in the Macaronesian Archipelagos - II. Final Report. Commission of the European Communities – DG XIV/C/1 – Study contract 95/095. Arquivos do DOP, Série Estudos, Nº1/99, 160pp.
- Menezes, Gui, A. Rogers, H. Krug, A. Mendonça, B. M. Stockley, E. Isidro, M. R. Pinho, A. Fernandes 2001. Seasonal changes in biological and ecological traits of demersal and deep-water fish species in the Azores. Final Report, European Commission DGXIV/C/1-Study contract 97/081.
- Mendonça, A., Estácio, S., Krug, H. Menezes, G. M., Branco, J., Pinho, M. R. 1998. Reproduction aspects of some demersal fishes captured in azores Archipelago. ICES CM. 1998/O:83.
- Meyer, R. and R. B. Millar. 1999a. BUGS in Bayesian stock assessments. *Can. J. Fish. Aquat. Sci.* 56: 1078-1086.
- Meyer, R. and R. B. Millar. 1999b. Bayesian stock assessment using a state-space implementation of the delay difference model. *Can. J. Fish. Aquat. Sci.* 56: 37-52.
- Moguedet, P. (1988). Approche de la dynamique de stocks accessoires : Le cas des lingues (*Molva* spp.) exploitées par la flottille industrielle Lorientaise. Lille, Université des Sciences et Techniques de Lille Flandre Artois: 301.
- Monstad, T., and A. Johannessen. 2001. Acoustic recordings of greater silver smelt (*Argentina silus*) in Norwegian waters and west of the British Isles, 1989-1994. *NAFO SCR Doc.* 01/112:17pp.
- Morales-Nin, B., Canha, Â., Casas, M., Figueiredo, I., Gordo, L.S., Gordon, J.D.M., Gouveia, E., Piñeiro, C. G., Reis, S., Reis, A. and Swan, S. C.. 2002. Intercalibration of age readings of deep-water black scabbard fish *Aphanopus carbo* Lowe, 1839 (in press)

- Murua, H. 2001. Roughhead Grenadier (*Macourus berglax*) biology and population structure in NAFO Divisions 3LMN. *NAFO SCR Doc.* 01/156:23pp.
- Pella, J. J. and P. K. Tomlinson. 1969. A generalized stock production model. *Bull. I-ATTC.* 13: 419-496.
- Piñeiro, C.G., M. Casas and R. Bañon. 2000. The deep-water fisheries exploited by Spanish fleets in the Northeast Atlantic: a review of the current status. *Fisheries Research* 51: 311-320. 8 p.
- Polacheck, T., R. Hilborn and A. E. Punt. 1993. Fitting surplus production models: comparing methods and measuring uncertainty. *Can. J. Fish. Aquat. Sci.* 50: 2597-2607.
- Prager, M. H. 1994. A suite of extensions to a non-equilibrium surplus production model. *Fish. Bull.* 92: 374-389.
- Prager, M. H., C. P. Goodyear and G. P. Scott. 1996. Application of a surplus production model to a swordfish-like simulated stock with time-changing gear selectivity. *Trans. Am. Fish. Soc.* 125: 729-740.
- Punt, A. E. 1990. Is $B_1=K$ an appropriate assumption when applying an observation error production-model estimator to catch-effort data? *S. Afr. J. Mar. Sci.*, 9: 249-259.
- Punt, A. E. and R. Hilborn. 1997. Fisheries stock assessment and decision analysis: the Bayesian approach. *Rev. Fish Biol. and Fish.* 7: 35-63.
- Quinn T.J. and Deriso R.B. 1999. *Quantitative Fish Dynamics*. Oxford University Press. New York. 1999. 542p.
- Rico V., J.M. Lorenzo, J.A., González, H.M. Krug, A. Mendonça, M.E. Gouveia and M. Afonso Dias, 2001. Age and growth of the alfonsino *Beryx splendens* (Lowe, 1834) from the Macaronesian archipelagos. *Fisheries Research*, 49(3): 233-240.
- Ronan, M.P., Bracken, J.J. and Molloy, J. 1993. Determination of biological characteristics of the greater argentine (*Argentina silus*) west of Ireland and Scotland. *EU FAR CT. MA.2.605*.
- Rosenberg, A. A., G. P. Kirkwood, J. A. Crombie and J. R. Beddington. 1990. The assessment of stocks of annual squid species. *Fish. Res.*, 8, 335-350.
- Sanders, M. J. 1988. Mean Population Number and the DeLury and Leslie Methods. *Fisheries Research*. 6: 153-165.
- Schaefer, M. B. 1954. Some aspects of the dynamics of populations important to the management of commercial marine fisheries. *Bull. Inter-Am. Trop. Tuna Comm.* 1: 27-56.
- Schnute, J. 1977. Improved estimates from the Schaefer production model: theoretical considerations. *J. Fish. Res. Bd. Can.* 34: 583-603.
- Schnute, J. 1985. A general theory for the analysis of catch and effort data. *Can. J. Fish. Aquat. Sci.* 42: 414-429.
- Sedberry, G.R., C.A.P. Andrade, J.L. Carlin, R.W. Chapman, B.E. Luckhurst, C.S. Manooch, G. Menezes, B. Thomsen, and G.F. Ulrich. 1999. Wreckfish *Polyprion americanus* in the North Atlantic: fisheries, biology, and management of a widely distributed and long-lived fish. *American Fisheries Society Symposium*. 23:27-50.
- Sobrino, I. and J. Gil 2001. Studies on age determination and growth pattern of the red (blackspot) seabream [*Pagellus bogaraveo* (Brünnich, 1768)] from the Strait of Gibraltar (ICES IXa/SW Spain): application to the species migratory pattern. NAFO Scientific Council Symposium on Deep-Sea Fisheries, Varadero, Cuba. Poster Presentation #4.
- Stefanescu, C., D. Lloris and J.Rucabado.- 1992. Deep-living demersal fishes in the Catalan Sea (western Mediterranean) below a depth of 1000 m. *J. Nat.Hist.*, 26: 197-213.
- Stockley, B.M., Rogers, A., Iyenger, A., Menezes, G., Santos, R. & Long, A. 2000 Ten microsatellite loci isolated and developed for the blackspot seabream, *Pagellus bogaraveo*. *Molecular Ecology*, 9: 999-1000.

- Svetovidov, A.N.- 1986. Gadidae. In: P.J.P. Whitehead, M.L. Bauchot, J.C. Hureau, J. Nielsen and E.Tortonese (eds.): *Fishes of the North-eastern Atlantic and the Mediterranean*, Vol. II, pp.680-710.UNESCO. Paris.
- Swan, S. C., Gordon, J. D. M and Shimmield, T. 2001 Preliminary investigations on the uses of otolith microchemistry for stock discrimination of the deep-water black scabbardfish (*Aphanopus carbo*) in the North East Atlantic. NAFO SCR Doc. 01/94 Serial No. N4482.
- Talman, S., Krusic-Golub, K., Ribertson, S. and Green, C. 2002. Age Estimation of deepwater fish species from the eastern north Atlantic. Queenscliff: Draft Report to An Bord Iascaigh Mhara (The Irish Sea Fisheries Board). 77 pp.
- Tave, D 1984. Quantitative genetics of vertebrae number and position of dorsal fin spines in the velvet belly shark, *Etmopterus spinax*. *Copeia*, **3**: 794-797.
- Tracey, D. M. and P. L. Horn 1999. Background and review of ageing orange roughy (*Hoplostethus atlanticus*, Trachichthyidae) from New Zealand and elsewhere. *New Zealand Journal of Marine and Freshwater Research* **33**: 67-86.
- Vinnichenko, V.I., 2002. Russian investigations and fishery on seamounts in the Azores Area. *Relatório da 18ª e 19ª Semana das Pescas dos Açores*, Horta, Portugal. 115-129.
- Walters, C. and D. Ludwig. 1994. Calculation of Bayes posterior probability distributions for key population parameters. *Can. J. Fish. Aquat. Sci.* 51: 713-722.
- Wood, R.J., and D.F.S. Raitt. 1968. Some observations on the biology of the greater silver smelt particularly in the north-eastern Atlantic Ocean. *Rapport et Proces-Verbaux des Reunions du Conseil Permanent International pour l'Exploration de la Mer.* 158:64-73.
- Yamakawa, T., Y. Matsumiya, M Nishimura and S. Ohnishi. 1994. Expanded DeLury's Method with Variable Catchability and its Application to Catch-Effort Data from Spiny Lobster Gillnet Fishery. *Fisheries Science.* 60: 59-63.
- Zheng, J. and C. J. Walters. 1988. Population dynamics and stock assessment of Wanshan Spring *Decapterus maruadsi* (T. & S.)

20.2 Working Documents

BIM. 2002. Deepwater Programme 2001. Scientific Report to ICES WGDEEP. 18 p+ 3 appendices.

Dobby, H. 2002. Stock assessment without age-structured data., 20 p.

Durán Muñoz, P., I. Loureiro & E. Román. 2002. Update available data on the Spanish multi-species deep-sea bottom trawl fishery at Hatton Bank (2000-2001). 9 p.

Figueiredo, I., and P. B. Machado. 2002. Longline fisheries off the Portuguese continental slope., 21 p.

Figueiredo, I., P. B. Machado, and M. Quaresma. 2002. Assessment of the Portuguese dogfish *Centroscymnus coelolepis* – a life table model application., 9 p.

Girard, M. 2002. Abundances indices and impact of the fishing activity.

Methods and preliminary results. 6 p.

Gil, J. and I. Sobrino. 2002. Update of the information about the red seabream (*Pagellus bogaraveo*) from the Strait of Gibraltar (ICES IXa south)., 5 p.

Hareide, N.-R., Fossen, I. and J. E. Dyb. 2002. Results from Norwegian Commercial and exploratory fisheries on Hatton Bank in 2001. 5 p.+ figs. and tabs.

Large, P. 2002. The use of stock reduction analysis to assess deep-water species in the ICES-area – an initial investigation., 5 p.

Lucio, P., Santurtún, M., Quincoces, I., Diez, G., Artetxe, A. and Iriondo, A. 2002. Overview on the deep-sea fisheries in the Basque Country (Spain) in 1999-2001., 15 p.

Melo, O. and G. Menezes, 2002. Exploratory fishing of the orange roughy (*Hoplostethus atlanticus*) in the Azores – preliminary results. 10 p.

Sigurdsson, T. 2002. Information on deep sea species in Icelandic waters., 19 p.

Vinnichenko, V.I., Khlivnoy, V.N., and Timoshenko, N.M., 2002. Russian deep-sea research and fisheries in the Northeast Atlantic in 2001., 12 p.

TECHNICAL MINUTES

Working Group on the Biology and Assessment of

Deep-Sea Fisheries Resources

ACFM Meeting May 2002

Subgroup Chair: Carmela Porteiro
Working Group Chair: Odd Aksel Bergstad
Reviewers: Andre Forest and Georges Kornilovs
Rapporteur: Steve Cadrin

Notes from WGDEEP Sub-Group Review

General Issues:

- Term of Reference f was addressed last year and was not covered in this year's report.
- Data availability continues to be a major problem. In particular, directed effort was not available for this year's report.
- The group noted that landings are generally increasing despite ACFM advice.
- Although alternative assessment applications were attempted for several stocks, they were either not possible or results were considered to be unreliable by the WG.
- The Subgroup proposed that the summary table on status of deepwater.
- The WG chair reported that the BIM 2002 report was not available at the WG meeting. Executive summaries will be distributed to ACFM in plenary. The Subgroup requested that the relevant information on discards and biological parameters be considered in the next WG report.

Specific Issues:

- Ling: The Icelandic survey provide new information that 2000 and 2001 biomass indices were the lowest in the observed series.
- Blue Ling: The Subgroup noted that the WG interpretation of the Icelandic survey may not be completely accurate. The Subgroup concurred that the survey indicates a substantial decline in biomass in the late 1990s to 10% of maximum observed in the series, followed by a modest increase to currently less than 20% of maximum.
- Tusk: The Subgroup noted a potential problem with the length frequencies from the Icelandic survey (Figure 9.5), because the 1985 survey indicated a large biomass, but few fish are in the length frequency relative to other years.
- Greater Silver Smelt: The Subgroup suggested that biological parameters be revised with new age data.
- Orange Roughy: A reviewer noted that the estimate of age at maturity noted in the text should be included in the biological parameters table.
- Roundnose Grenadier: The Subgroup noted that there is no information on changes in the fishery that would explain an increase in CPUE. The Subgroup also noted a potential problem with CPUE=0 for the directed fishery in area VII in 1989 and 1990 in Table 12.2 and Figure 12.1.
- Red Seabream: A reviewer noted a problem with legends for Figures 14.1-14.5. The Subgroup requested that a table of biological parameters be included in the next WG report.
- Deepwater Sharks: The Subgroup noted a potential problem with CPUE=0 for the directed fishery in area VII in 1990 in Table 17.2 and Figure 17.2.