

Flødevigen rapportser. 1, 1984. ISSN 0333-2594  
The Propagation of cod *Gadus morhua* L.

FOOD CONSUMPTION RATE AND GUT EVACUATION PROCESSES OF  
FIRST FEEDING COD LARVAE (*Gadus morhua* L.)

S. Tilseth and B. Ellertsen

Institute of Marine Research, P.O. Box 1870,  
N-5011 NORDNES Norway

ABSTRACT

Tilseth, S. and Ellertsen, B., 1984. Food consumption rate and gut evacuation processes of first feeding cod larvae (*Gadus morhua* L.). In: E. Dahl, D.S. Danielssen, E. Moksness and P. Solemdal (Editors), The Propagation of Cod *Gadus morhua* L. Flødevigen rapportser., 1, 1984:167-182.

Laboratory experiments with cod larvae (*Gadus morhua* L.) during optimum feeding conditions showed that cod larvae were sporadic feeders rather than continuous feeders. Digestion rate of copepod nauplii was less than 30 min, but varied with gut content volume. The cod larval gut evacuation rate varied with food availability and state of digestion of the gut content. Criteria for larval gut content analysis for the evaluation of the cod larval feeding conditions in the sea are given.

INTRODUCTION

Several studies have been carried out to find cod larval prey species and size selection, both in field studies (Wiborg, 1948; Marak, 1960; Bainbridge and McKay, 1968; Last, 1978; Ellertsen et al., 1977), laboratory studies (Ellertsen et al., 1980), and in enclosure studies (Ellertsen et al., 1981). These authors found that the main cod larval prey organism was copepod nauplii. The size range of nauplii most frequently captured by first feeding cod larvae was within

100-500  $\mu\text{m}$  (carapace length). Conclusions have consequently been made on the early cod larval selection of prey species and sizes. The larval gut filling rate, gut evacuation rate and digestion time of the main prey organism are, however, not well known. This information combined with gut content analyses of field sampled cod larvae and plankton can enable better estimates on the larval feeding conditions at the place and time of capture.

The objectives of this study are to present data on cod larval feeding rate, gut evacuation time and digestion time of copepod nauplii and applying these results in defining criteria for cod larval gut content analyses for the evaluation of larval feeding conditions in the sea.

The present study is based on laboratory experiments on first feeding cod larvae under optimal feeding conditions as described by Ellertsen et al. (1980).

#### MATERIALS AND METHODS

Cod eggs were stripped from different female fish kept separate and artificially fertilized. Ten ml of eggs from each group were incubated in 10 l aquaria in stagnant filtered (7  $\mu\text{m}$  and 1  $\mu\text{m}$  Fulflo filters in series) and UV-irradiated sea water. The temperature was kept constant at 5°C. Antibiotics were administered according to Shelbourne (1963), supplemented with 2.5 I.E. mycostatine/ml. The antibiotics were only given in one dose on the first day of incubation. The aquaria were gently aerated with filtered air (0.22  $\mu\text{m}$  Millipore filter) during the period of incubation.

A homogenous age group of larvae were made by removing all larvae hatched during the first 24 h of the hatching period and all unhatched eggs 48 h later. All experiments were performed 7 days post-hatching.

Natural plankton was sampled by an automatic pump system described by Tilseth et al. (1983). The size range of the

prey varied, due to the filters of the system within 90-500  $\mu\text{m}$ .

The feeding experiments were performed in 5 l black walled aquaria at constant temperature ( $5^{\circ}\text{C}$ ). The light condition was kept constant at 100 lux by neutral filters. The light intensity was measured at the surface by a Tektronix J16 photometer with an illuminance probe J6511 (color corrected within 2% of the C.I.E. photopic curve) with a maximum sensitivity at about 550 nanometer. The aquaria were gently bubbled to keep the prey as evenly distributed as possible during feeding. After the feeding period, cod larvae were preserved in 4% formaline in  $10^{\circ}/\text{oo}$  sea water to avoid shrinkage.

#### Feeding experiments

A total of 160 cod larvae from each of two different female fish (A and B) were transferred from their incubators to 16 feeding aquaria, which were stocked with 20 larvae. These aquaria were stocked with prey organisms (0.5/ml) just prior to the experiments. Twenty larvae were sampled for gut content analysis at 15 min intervals for 1 h followed by 1 h intervals. The experiments were terminated after 4 h (group A) and 5 h (group B) respectively.

#### Digestion time

Cod larvae were observed in vivo during feeding. The larvae change swimming pattern when capturing prey (described by Ellertsen et al., 1981). After successful capture of prey these larvae were transferred to a small aquarium (Fig. 1) where the gut content of the transparent larvae could be observed by a binocular microscope. The gut content of these larvae were after 30 min dissected out and stained with 1% toluidine blue in 1% borax.

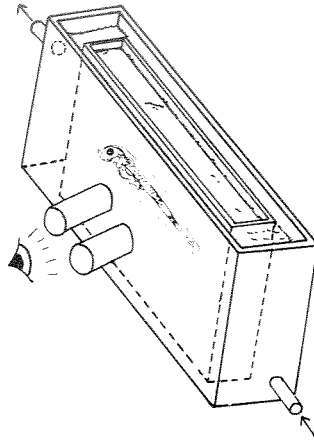

Fig. 1. Cod larvae in vivo observation aquarium (10 cm x 10 cm x 2 cm). The aquarium was submerged in a glass thermostatically controlled waterbath (5°C) during observation.

#### Gut evacuation time

One hundred and fifty larvae (group B) were fed 0.5 prey/ml for 1 h. Immediately after the feeding period twenty larvae were preserved for gut content analysis. The remaining 130 larvae were gently transferred to a 1 l beaker with filtered sea water. As a procedure to get rid of the prey organisms, about 2/3 of the volume were siphoned out, and the same volume of filtered water was added. This procedure was repeated two times before the larvae were transferred to a 5 l aquaria of filtered water. Twenty larvae were sampled for gut content analysis in 30 min intervals for 2 h followed by 1 h intervals for 2 h.

#### 24 hour feeding experiment

Five hundred cod larvae (group C) were transferred to a 70 l aquarium stocked with 0.1 prey organism/ml. The prey organisms were evenly distributed in the aquarium through an "air

lift system". Twenty larvae were sampled for gut content analysis every hour through a 24 hour period. The aquarium was covered by a 10% neutral filter. The light intensity varied between 100 lux and 200 lux during day time, decreasing from 1900 h to 2400 h when it reached a minimum of 0.5 lux and increased to 100 lux at 0500 h the next day when the experiment was terminated at 1130 h.

## RESULTS

### Feeding experiments

Ninety-seven percent of the prey organisms identified in the gut content analysis were copepod nauplii, 1.6% could not be identified and 1.4% were bivalve veliger larvae, rotifers and copepod eggs.

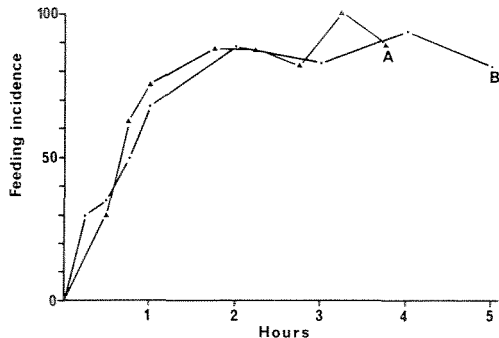

Fig. 2. Percentage of cod larvae with stomach contents (feeding incidence) during a feeding experiment, group A larvae (A) and group B larvae (B). All larvae are 7 days post-hatching.

The results of the gut content analysis are given as cod larval feeding incidence (Fig. 2) and cod larval feeding ratio (Fig. 3). Cod larval feeding incidence is defined as the percentage of cod larvae with gut contents. Fig. 2 shows

the feeding incidence during the feeding experiment lasting 4 h in group A larvae and 5 h in group B larvae. The feeding incidence increased rapidly and reached a level of 90% in both groups during the first 2 h.

In group A larvae the feeding incidence varied between 83% and 100% through the next 2 h and between 80% and 93% during the next 3 h in group B larvae.

The cod larval feeding ratio is defined as the ratio between the number of prey found in the gut contents to the number of larvae examined in the sample. Fig. 3 presents the feeding ratio against time during the feeding experiment.

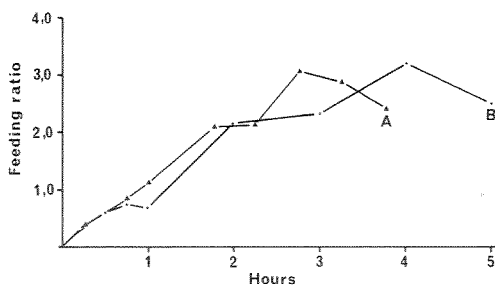

Fig. 3. The ratio between the number of prey items found in the larval gut contents to the number of larvae examined in group A larvae (A) and group B larvae (B). All larvae are 7 days post-hatching.

The feeding ratio increased during the first 3 h of feeding in group A larvae and for 4 h in group B larvae, reaching a maximum of 3.1 nauplii/larval gut in group A, and 3.2 nauplii/larval gut in group B larvae. This seems to be the maximum level of gut filling. An estimate of the volume of a mean size nauplius most frequently captured by first feeding cod larvae gave a volume of 91  $\mu$ l (estimated to be spherical with its appendages,  $r=130 \mu$ m). The mean volume of a distended gut (cylindrical) of a 4.5 mm standard length cod larvae was estimated to be 329  $\mu$ l. This gives a maximum estimated feeding ratio of 3.5 nauplii/larval gut, which shows that the average larva cannot fill its gut with more

than 3 or 4 nauplii at a time. As demonstrated in Fig. 3 the time to reach the maximum gut filling level was 2 h and 45 min in group A larvae and 4 h in group B larvae. A linear regression analyses of the data within these time intervals gave a feeding rate of 1.13 nauplii/larval gut per hour ( $y=0.10+1.03 x$ ,  $r^2 = 0.97$ ) in group A, and 0.94 nauplii/larval gut per hour ( $y=0.18+0.76 x$ ,  $r^2 = 0.96$ ) in group B larvae. A t - test showed that the difference in slope (e.g. feeding rate) was highly significant ( $p>0.0001$ ).

This means that the larvae in group A were more efficient feeders than group B larvae. The mean standard length of larvae in group A was 5.1 mm and 4.4 mm for those in group B.

#### Digestion time

The digestion time of prey captured by cod larvae is, in the present study, defined as the time for the gut content to become transparent.

The results from the visual observation of a nauplius (220  $\mu\text{m}$  carapace length) in the gut of a 7 days old cod larvae showed that the nauplius became transparent within 30 min. Smaller nauplii were observed in a transparent state after approximately 15-20 min. Fig. 4 shows a photo of 3 nauplii

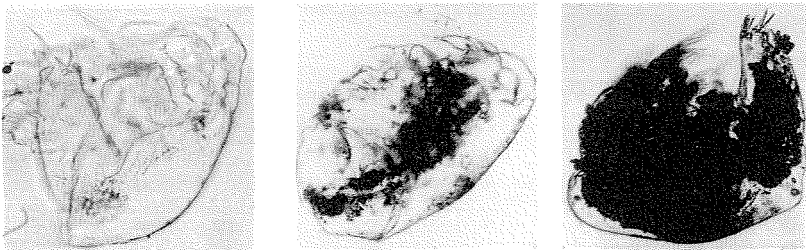

Fig. 4. Nauplii dissected from a 7 days old larvae after a 30 min feeding period. The nauplii are colored with 1 % toluidine blue in 1 % borax prior to photographing.

all dissected out from the gut of 7 day old cod larvae, which had been feeding for 30 min. Nauplius A is not or very little affected by the process of digestion and is defined as digestion category 1 (dc1). In nauplius B most of the soft parts are dissolved, defined as digestion category 2 (dc2), and in nauplius C only the exuviae are left, defined as digestion category 3 (dc3). Exuviae were never observed to be affected by the digestion process, but often the appendages fall off and the exuviae collapse.

#### Gut evacuation time

The gut content analysis from the gut evacuation experiments with group B larvae are presented in Fig. 5. The experiment was run in two steps, starting with a 1 h feeding period followed by a 4 h starvation period.

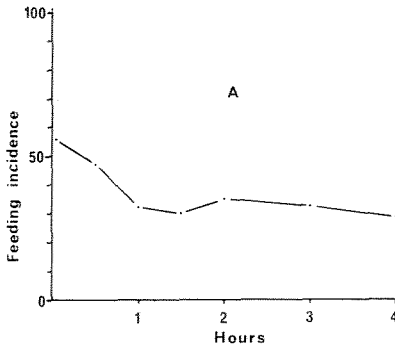

Fig. 5A. Percentage of cod larvae with stomach content (feeding incidence) during a gut evacuation experiment performed on 7 days old group B larvae. For further explanation see text.

In Fig. 5A is presented the observed feeding incidence showing that the larvae had reached 56% feeding incidence during the feeding period. The feeding incidence was reduced to 30% during 1 h of starvation. In the following 3 h of



starvation very little variation in the cod larval feeding incidence was observed. This shows that about 50% of the larvae which had been able to feed emptied their gut completely during the first hour of starvation, while the other half retained their gut contents. This is demonstrated in more detail in Fig. 5B.

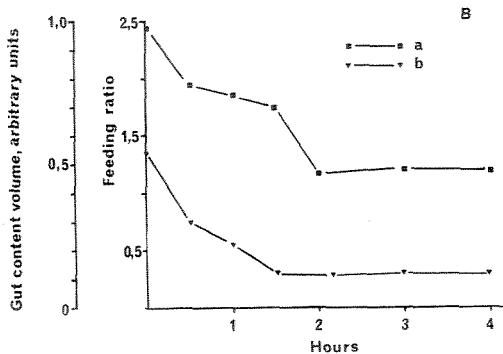

Fig. 5B. Feeding ratio calculated for larvae found with stomach contents in gut evacuation experiment (a), and the volume of prey based upon different digestion categories (b). For further explanation see text.

The larval feeding ratio is in this case only calculated for the larvae with gut contents from each sample. Fig. 5B(a) shows a feeding ratio of 2.4 nauplii/larval gut after the termination of the feeding period. This was reduced to 1.3 nauplii/larval gut during 2 h of starvation. During the next 2 h no further reduction in larval feeding ratio was observed.

The reduction in amount of digestable gut content is presented in Fig. 5B(b). The volume of the digestable organic material of prey is given in arbitrary units based on the different digestion categories, where dc1 is given the value 1.0, dc2 the value 0.5 and dc3 the value 0.1. (In dc3 the exuviae are almost always observed in a collapsed state)

Fig. 5B(b) shows that the volume of the gut content was 0.55 at the start of the starvation period and decreased to 0.13 after 1 h and 30 min, with no further reduction in the following 3 h and 30 min.

#### 24-hour feeding experiments

The main prey organisms sampled and fed to the cod larvae during the 24 h feeding experiment were bivalve veliger larvae (62%), and copepod nauplii (35%). Only a few rotifers and copepod eggs (3%) were found.

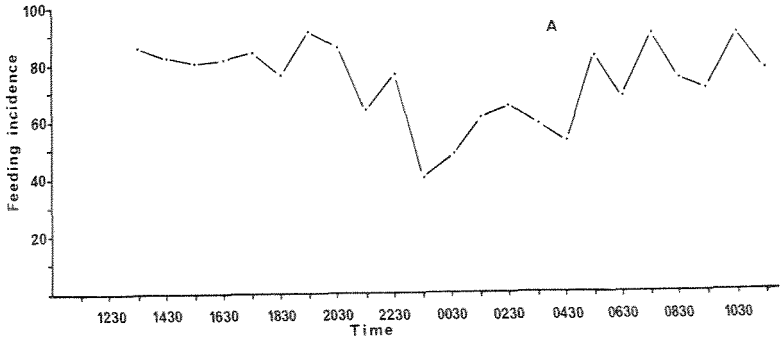

Fig. 6A. Percentage of cod larvae with stomach content (feeding incidence) during a 24 h feeding experiment. For further explanation see text.

The results from the gut content analyses from the 24 h feeding experiment are presented in Fig. 6. The variation in cod larval feeding incidence during the 24 h period is presented in Fig. 6A. A level of 87% feeding incidence was observed 3 h after the start of the experiment. During the next 6 h only minor variation in feeding incidence was found. A decrease in feeding incidence was observed during the hours of light reduction to a minimum level of 40% at 2330 h, showing that about 50% of the larval population which had been able to feed had evacuated their gut. The feeding incidence increased again after midnight with increasing light intensity, varying between 77% and 90%.

Fig. 6B shows the cod larval feeding ratio, presented as the number of prey/larval gut (a), the number of bivalve veligers/larval gut (b) and the number of nauplii/larval gut (c).

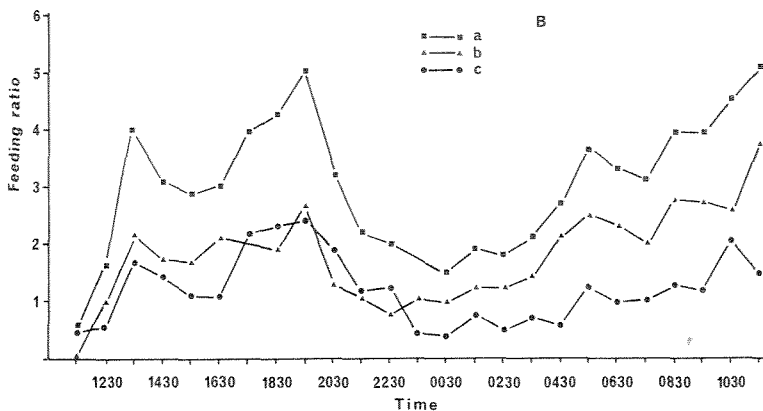

Fig. 6B. Average number of prey items in the cod stomachs (feeding ratio) during a 24 h feeding experiment (a), the number of bivalve veligers/larval gut (b), and the number of nauplii/larval gut (c).

The feeding ratio increased to 4.0 prey/larval gut during the first 3 h of feeding which gave a feeding rate of 1.3 prey/larval gut per h. The gut content analyses showed that the larvae contained 59% bivalve veliger larvae and 41% copepod nauplii. The cod larvae population stopped active feeding after this period, as demonstrated by the reduction in feeding ratio from 4.0 prey/larval gut to 3.0 prey/larval gut during the following 3 h.

These two periods were followed by another 3 h period of active feeding, demonstrated by the increase in feeding ratio from 3 prey/larval gut to 5.1 prey/larval gut from 1630 h to 1930 h. This gives a feeding rate of 0.7 prey/larval gut per h. The cod larval feeding ratio then decreased concomitantly with the reduction in light intensity from 1930 h to 0030 h. Both bivalve veligers and nauplii were defecated.

The feeding ratio was less than 2 prey/larval gut during night time (2230 h to 0430 h). An increase in cod larval feeding ratio on bivalve veliger larvae was, however, observed from 0030h, indicating that these prey organisms might be more easy to capture at low light intensities. After midnight 2 feeding periods were observed, from 0230 h to 0530 when the feeding ratio increased to 3.5 prey/larval gut, followed by a passive period from 0530 h to 0730 h with a reduction in feeding ratio to 3.1 prey/larval gut. The feeding ratio increased again during the last 4 hours of the experiment, reaching a level of 5.1 prey/larval gut at 1130 h when the experiment was terminated. The bivalve veliger larvae dominated the gut contents in all samples after midnight. These prey organisms were, however, found digested (the two shells separated and the content dissolved) in only 3 samples, the first one 4 hours after the start of the experiment. The veliger larvae were, however, observed stuffed like plates when these prey increased in numbers. While in all samples the majority of the copepod nauplii were found in digestion category 3, only between 4% to 20% were found in dc1 and dc2.

Newly captured copepod nauplii (dc1) were found in the gut content of cod larvae in all samples, with the exception of two samples during the dark period at 2330 h and at 0130 h.

## DISCUSSION

During the present feeding experiments of cod larvae, the conditions for feeding both with regard to light intensity (Ellertsen et al., 1980) and prey density (Solberg and Tilseth, 1984) were kept at an expected optimum level. Under these conditions evidence presented in this paper suggests that cod larvae do not feed continuously (Fig. 6B), but are sporadic feeders having intervals between feeding to digest food. This was also suggested by Marak (1960) from field studies on cod larvae. Other fish larvae, however, have been

demonstrated to be continuous feeders (largemouth bass, *Micropterus salmoides*, Laurence, 1971, and herring, *Clupea harengus*, Werner and Blaxter, 1981). This contrast could be due to the relatively small gut volume and rapid digestion rate in cod larvae. The digestion time is understood as the time from ingestion of the prey until it becomes transparent. This proved to be dependent on the amount of digestable organic material in the gut. The digestion time increased from less than 30 min for a single nauplius to 1 h and 30 min when the average larval gut content was 2.5 nauplii/larval gut (Fig. 5B).

The cod larval feeding rate was evidently dependent on the strategy of feeding as demonstrated in Fig. 3 and 6B, showing a linear increase in number of prey captured until gut maximum filling was reached. The shape and volume of the digested nauplii are still intact in this period and become later collapsed.

Even if the prey density was kept at an optimum level, difference in feeding rate between larval groups of different standard length was observed. The larger larvae proved to have a higher feeding rate than smaller ones (Fig. 3). The maximum gut filling however, did not differ. The feeding rate was obviously also modified by the previous feeding or rather the volume of the gut content. This was demonstrated in the continuous feeding experiment (Fig. 6B) showing a feeding rate of 1.3 prey/larval gut per hour during the first period of active feeding, being reduced to 0.7 prey/larval gut after the period of digestion. The larval gut maximum filling seems to be a function of volume and state of digestion of the gut content. This is also demonstrated in Fig. 3 and 5B, showing that, when the larvae were allowed to feed for only 4 to 5 h the maximum filling was 3.1 nauplii/larval gut (group A) and 3.2 nauplii/larval gut (group B) (Fig. 2). When the larvae were allowed to feed for 24 h, however, the maximum filling increased from 3.2 prey/larval gut to 5.1 prey/larval gut during 9 h (Fig. 6B).

The passage of prey through the gut varies with temperature (Laurence, 1971) and prey density (Werner and Blaxter, 1980). This is probably also true for cod larvae, but varies also with larval gut filling or volume of gut content related to prey availability. This is demonstrated in Fig. 5A and B, showing only a minor drop in feeding incidence and that the larvae did not defecate undigestible remains during starvation. During the *in vivo* experiments cod larvae were also fed coloured prey in order to study the passage of prey through the larval gut as described by Laurence (1971). Inspection of these larvae by microscope showed that when the larvae had filled their gut with 2 to 3 nauplii the peristaltic movement of the gut increased. This action altered the position of the nauplii in the larval gut. Consequently the staining method described by Laurence (1971) could not be applied in the study of food passage through the cod larval gut.

Cod larvae were never observed during the feeding experiments to defecate their gut due to handling or preservation, which has been observed in herring larvae (Blaxter, 1965; Rosenthal and Hempel, 1970). When food was available all the time, the larvae filled their gut volume in 3 h, but did not evacuate the gut (Fig. 6B), indicated by no reduction on feeding incidence during the following digestion period of 3 hours (Fig. 6A). The volume of the larval gut content was evidently reduced through this period. The larvae started evacuation of their gut content when the gut filling had reached a level of 5.1 prey/larval gut, 9 h after the start of the experiment. At this level the gut volume was obviously filled with undigestible prey or remains. The larval gut content at this stage contained 45% nauplii and 55% bivalve veliger larvae. Only a few bivalve veliger larvae were found digested, indicating that cod larvae do not seem to be able to digest bivalve veliger larvae. This was also observed in first feeding herring larvae by Fossum (1983).

Cod larvae started to evacuate the gut concomitantly with the reduction in light intensity, which could have influenced

the process of gut evacuation. The light intensity did not, however, drop below the threshold for visual feeding which is reported to be close to 0.1 lux by Ellertsen et al. (1980). Newly captured nauplii, dcl, were found in the gut content showing that the larvae were able to feed during the "dark hours". This was also observed by Gjøsæter and Tilseth (1982) in cod larvae sampled at night in the Lofoten area.

The objective of the present study was also to find criteria for cod larval gut content analyses for the evaluation of larval feeding conditions in the sea. Based on the results from these investigations the cod larval feeding incidence must be evaluated together with the larval feeding ratio. A high percent feeding incidence does not necessarily indicate good feeding conditions, because cod larvae could keep the gut content for several hours during starvation. Cod larval feeding ratio is in the present study defined as the ratio between the number of prey found in the gut content to the number of larvae examined in the sample. A feeding ratio  $<1.0$  prey/larval gut clearly indicates several larvae of the sample with empty guts, and if no newly eaten copepod nauplii are found then there are good reasons for believing that the larval population has been starving for several hours. Good feeding conditions however are indicated in larval gut content analyses when the feeding incidence is  $>90\%$  and feeding ratio is  $>3.0$  prey/larval gut. If copepod nauplii are the main prey organisms and more than  $10\%$  are found in dcl (newly eaten), then the availability of food to first feeding cod larvae may be considered as good.

#### REFERENCES

- Bainbridge, V. and McKay, B.J., 1968. The feeding of cod and redfish larvae. Spec. Publs. ICNAF, 7: 187-217.
- Blaxter, J.H.S., 1965. The feeding of herring larvae and their ecology in relation to feeding. Rep. Calif. Coop. oceanic Fish. Invest., 10: 79-88.
- Ellertsen, B., Moksness, E., Solemdal, P., Strømme, T., Tilseth, S., Westgård, T. and Øiestad, V., 1977. Vertical distribution and feeding of cod larvae in relation to

- occurrence and size of prey organisms. Coun. Meet. int. Coun. Explor. Sea, 1977 (F:34): 1-31. (Mimeo.)
- Ellertsen, B., Moksness, E., Solemdal, P., Strømme, T., Tilseth, S., Westgård, T. and Øiestad, V., 1980. Some biological aspects of cod larvae (*Gadus morhua* L.) FiskDir. Skr. Ser. HavUnders., 17: 29-47.
- Ellertsen, B., Moksness, E., Solemdal, P., Tilseth, S., Westgård, T. and Øiestad, V., 1981. Growth and survival of cod larvae in an enclosure. Experiments and a mathematical model. Rapp. P.-v. Réun. Cons. int. Explor. Mer, 178: 45-57.
- Fossum, P., 1983. Digestion rate of food particles in the gut of larval herring (*Clupea harengus* L.). Fisk. Dir. Skr. Ser. HavUnders., 17: 347-357.
- Gjøsæter, H. and Tilseth, S. 1982. Primary growth increments in otoliths of cod larvae (*Gadus morhua* L.) of the Arcto-Norwegian Stock. FiskDir. Skr. Ser. HavUnders., 17: 287-295.
- Last, J.M., 1978. The food of three species of gadoid larvae in the eastern English channel and southern North Sea. Mar. Biol., 48: 377-386.
- Laurence, G.C., 1971. Digestion rate of larval largemouth bass. N.Y. Fish Game J., 18: 52-56.
- Marak, R.R., 1960. Food habits of larval cod, haddock and coalfish in the Gulf of Maine and Georges Bank area. J. Cons. perm. int. Explor. Mer, 25: 147-157.
- Rosenthal, H., and Hempel, G., 1970. Experimental studies in feeding and food requirements of herring larvae (*Clupea harengus* L.). In: J.H. Steele (Editor), Marine food chains. Univ. Calif. Press, Berkeley, 552 pp.
- Shelbourne, J.E., 1963. A marine fish-rearing experiment using antibiotics. Nature, 193: 74-75.
- Solberg, T. and Tilseth, S., 1984. Growth, energy consumption and prey density requirements in first feeding larvae of cod (*Gadus morhua* L.). In: E. Dahl, D.S. Danielssen, E. Moksness and P. Solemdal (Editors), The Propagation of Cod *Gadus morhua* L. Flødevigen rapportser., 1, 1984:145-166.
- Tilseth, S., Solberg, T. and Westrheim, K., 1983. Sublethal effects of the water-soluble fraction of Ekofisk crude oil on the early larval stages of cod (*Gadus morhua* L.) Marine Environmental Research, (In press).
- Werner, R.G. and Blaxter, J.H.S., 1980. Growth and survival of larval herring (*Clupea harengus* L.) in relation to prey density. Can. J. Fish. Aquat. Sci. 37: 1063-1069.
- Werner, R.G. and Blaxter, J.H.S., 1981. The effect of prey density on mortality, growth and food consumption in larval herring (*Clupea harengus* L.). Rapp. P.-v. Réun. Cons. int. Explor. Mer, 178: 405-408.
- Wiborg, K.F., 1948. Investigations on Cod larvae in the coastal waters of northern Norway. FiskDir. Skr. Ser. HavUnders., 9(3): 1-27.