

ATLAS OVER MIDDELTEMPERATUR, SALTHOLDIGHET OG TETTHET

OM SOMMEREN FRA NORDLIGE NORDSJØEN

[Atlas of mean temperature, salinity and density in the summer  
from the northern North Sea.]

Av

RIKARD LJØEN

Fiskeridirektoratets Havforskningsinstitutt.

FORORD

Innledning

Siden 1967 har Fiskeridirektoratets Havforskningsinstitutt hver sommer gjennomført standard hydrografiske program i Nordsjøen og Skagerrak. Undersøkelsene har hver gang dekket området mellom breddeparallelene  $57^{\circ}00'N$  og  $60^{\circ}45'N$ , østkysten av Storbritania og en linje mellom Torungen, Norge, og Hirtshals, Danmark.

Denne presentasjonen er basert på ti års observasjoner i perioden 1967 - 1976.

Observasjonene

De hydrografiske snittene er alltid tatt langs rette kurser. De snittene som er vist i Fig. 1 faller sammen med de som oftest har vært brukt. I disse snittene er stasjonene tatt på standard posisjoner. Disse posisjonene er vist på figuren og brukt til denne presentasjonen.

Stasjonene er delt i to grupper. Den ene gruppen omfatter de stasjoner hvor alle observasjonene er foretatt innenfor fem nautiske mil fra standard posisjon. Denne posisjonen er merket x i Fig. 1. I den andre gruppen er en eller flere stasjoner tatt i en avstand mellom fem og femten nautiske mil fra standard posisjon. Denne posisjon er merket o. Syv av disse inkluderer en stasjon med avstand større enn femten nautiske mil. Standard posisjonene for disse er:

59°34'N 01°56'V, 59°17'N 01°19'V, 58°10'N 01°40'V,  
58°10'N 01°20'V, 58°10'N 00°52'V, 58°10'N 00°23'V, og  
58°10'N 01°00'Ø.

Observasjonene er foretatt i perioden fra midten av mai til midten av juli hvert år. Tabell 1 viser observasjonsdato på hvert av snittene de enkelte årene. To eller flere datoer antyder at hele snittet ikke er observert fortløpende, eller at en del av stasjonene er repetert. Observasjonsdatoene er gruppert innen intervall på fem dager, og Fig. 2 viser frekvensen av disse intervallene for hele materialet.

### Behandling og presentasjon av data

Ti års middel av temperatur ( $t^{\circ}\text{C}$ ), saltholdighet (S o/oo) og tetthet ( $\sigma_t$ ) i ICES standard dyp er basert på en verdi hvert år. Dersom det et år er foretatt flere observasjoner på en stasjon, er parametrene representert ved gjennomsnittsverdiene det året. På områder hvor bunndypet varierer meget med horisontal avvik fra standardposisjon, kan interpolerte eller ekstrapolerte verdier være brukt nær bunnen.

Standardavvik for de enkelte parametrene er beregnet ved formelen:

$$SD = \sqrt{\frac{\sum y^2 - \frac{(\sum y)^2}{n}}{n-1}}$$

hvor y er en enkel eller gjennomsnittsverdi, og n er antall verdier.

Gjennomsnittsverdier med standard avvik (SD) for de tre nevnte parametrene er presentert i de ti snitt som er nummerert I til X i Fig. 1 og i horisontale kart som representerer overflaten, 50 m dyp og forholdene nær bunnen uavhengig av dyp.

En del tilleggsstasjoner som ikke er vist i Fig. 1, men som ble tatt vestenfor 2° ØL mellom 57° NB og 58° NB synoptisk med det øvrige materialet, har til en viss grad bestemt fordelingen av de tre parametrene i dette området.

## Takk

Forfatteren retter en stor takk til Berit Hoffstad som har systematisert materialet og lagt det opp til regnemaskinbehandling. Jeg takker også Harald Kismul som har utført tegnearbeidet.

## PREFACE

### Introduction

Every summer since 1967 the Institute of Marine Research has carried out standard hydrographical programs in the North Sea and Skagerrak. The investigations covered in minimum an area between the parallels  $57^{\circ}00'N$  and  $60^{\circ}45'N$ , the coastal waters off Great Britain and a line between Torungen, Norway, and Hirtshals, Denmark.

This presentation is based on ten years of observations during the period 1967 - 1976.

### Observations

The hydrographical stations were always taken along straight lines and the sections appearing in Fig. 1 are those which were worked most frequently. In these sections most of the stations were sited at the standard positions which are indicated in the figure, and which are used for the presentation.

The stations are divided into two groups. The first one includes all points of observations within a distance of five nautical miles from the standard position and is lettered x. In the second group one or more points of observation have a distance between five and fifteen nautical miles from the standard position and are shown by an o in the figure. However, seven standard positions of these include one observation point at a greater distance than fifteen nautical miles. They are:

$59^{\circ}34'N$   $01^{\circ}56'W$ ,  $59^{\circ}17'N$   $01^{\circ}19'W$ ,  $58^{\circ}10'N$   $01^{\circ}40'W$ ,  $58^{\circ}10'N$   $01^{\circ}20'W$ ,  
 $58^{\circ}10'N$   $00^{\circ}52'W$ ,  $58^{\circ}10'N$   $00^{\circ}23'W$  and  $58^{\circ}10'N$   $01^{\circ}00'E$ .

The observations were performed each year from the middle of May to the middle of July. The dates of observations are shown in Table 1. Two or more dates indicate that the complete section was not covered continuously in time, or that all or some of the stations were repeated.

The observation times are grouped in intervals of five days, and Fig. 2 shows their frequency distribution, comprising the complete material.

### Treatment of data and presentation

Averages of temperature ( $t^{\circ}\text{C}$ ), salinity (S o/oo) and density ( $\sigma_t$ ) at ICES standard depths are based on one value per year. In case of repetition the average of that year's observations has been used. In areas where the bottom depth alters abruptly, some interpolated or extrapolated values may have been used near the bottom.

Standard deviations of the parameters are computed by the formula:

$$SD = \sqrt{\frac{\sum y^2 - \frac{(\sum y)^2}{n}}{n-1}}$$

where  $y$  is the value of single or average data and  $n$  the number of values used.

Average values and standard deviations (SD) of the parameters are presented in all ten profiles (I-X, Fig. 1) and diagrams representing the sea surface, the 50 m depth and near bottom level.

Auxiliary observations taken to the west of  $2^{\circ}\text{E}$  between the parallels  $57^{\circ}\text{N}$  and  $58^{\circ}\text{N}$  have, to a certain extent, guided the plotting of the course of the isolines in that area. The positions of these stations are not included in Fig. 1.

Acknowledgements

The author is indebted to Berit Hoffstad for systematizing the material and preparing it for computation. Thanks also to Harald Kismul for doing the drawings.

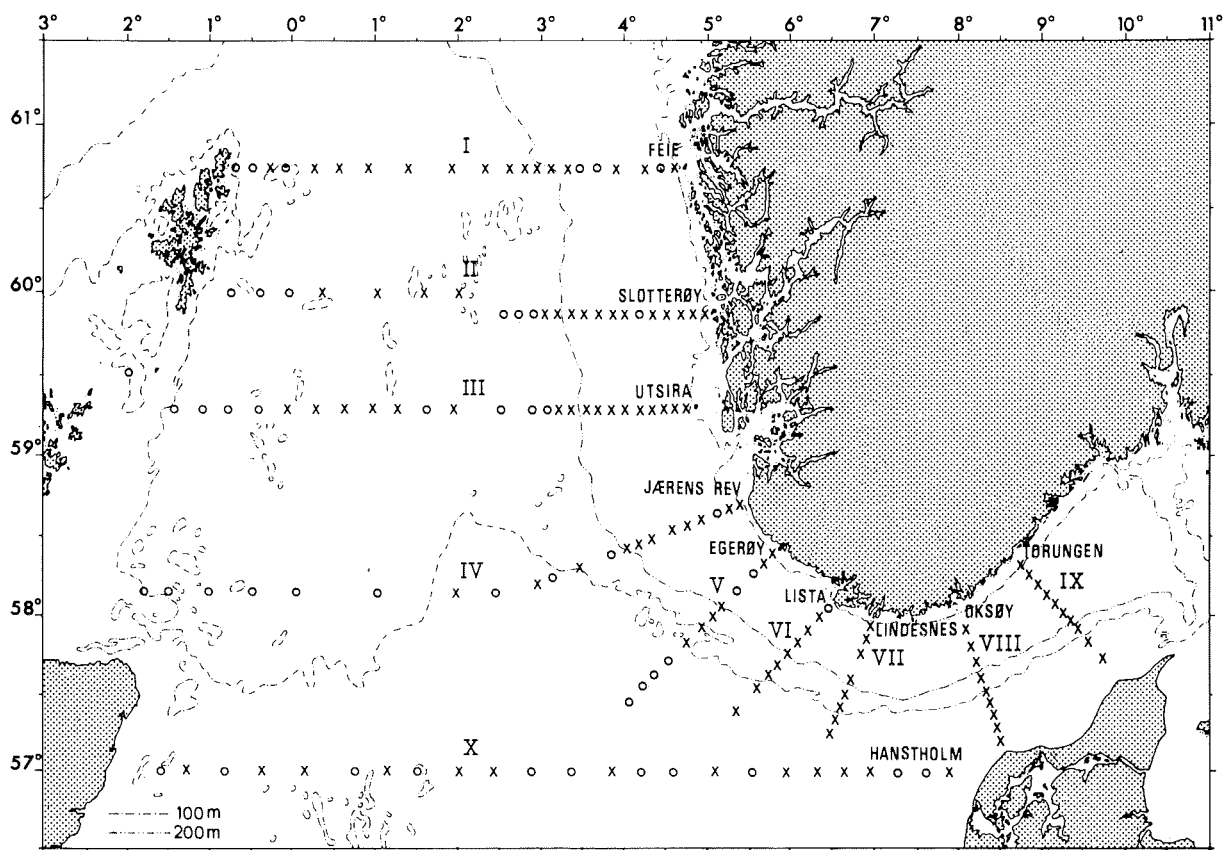

Fig. 1. Stasjonsnett. For symbolene, se teksten. [Grid of stations. For symbols see the text].

Tabell 1. Observasjonsdato på de enkelte snittene. Se Fig. 1. [Date of observations on the separate sections. See Fig. 1].

	I			II			III			IV			V		
	may	June	July	may	June	July	may	June	July	may	June	July	may	June	July
1967		o			o	o		o	o		o	o			o
68			o		o	o		o	o		o	o			o
69			o		o	o		o	o		o	o			o
70			o		o	o		o	o		o	o			o
71	o				o	o		o	o		o	o			o
72			o		o	o		o	o		o	o			o
73	o				o			o			o				o
74	o				o			o			o	o			o
75			o		o	o		o		o		o		o	
76		o			oo			o		o		o		o	

	VI			VII			VIII			IX			X		
	may	June	July	may	June	July	may	June	July	may	June	July	may	June	July
1967			o			o			o			o			o
68		o			o			o			o			o	
69		o			o			o			o			o	
70		o			o			o			o			o	
71		o			o			o			o			o	
72			o			o			o					o	
73		o			o			o			o			o	
74		o			o			o			o			o	
75	o				o				o		o			o	
76	o				o			o		o				o	

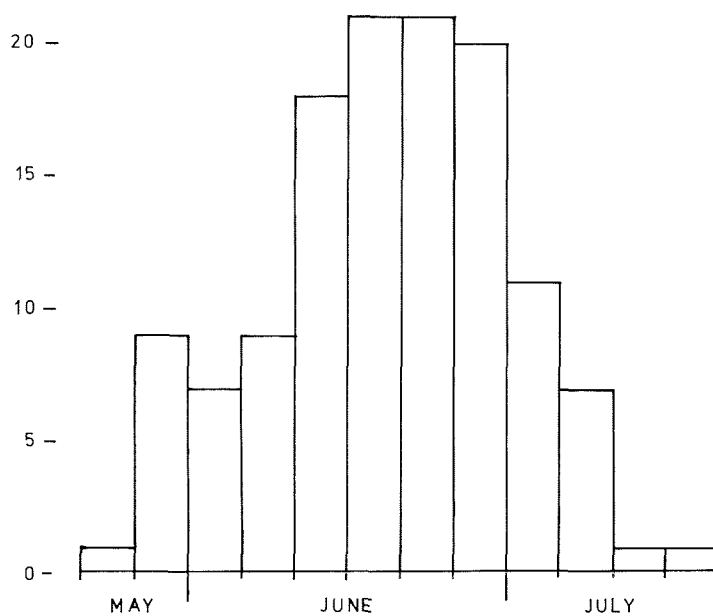
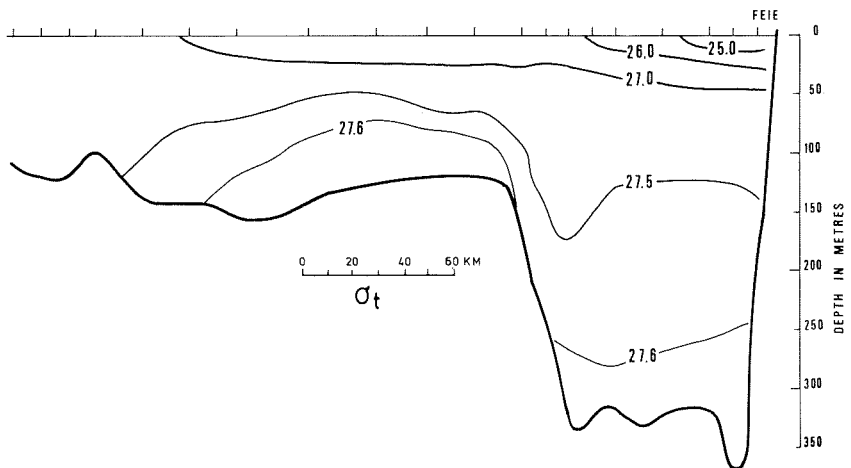
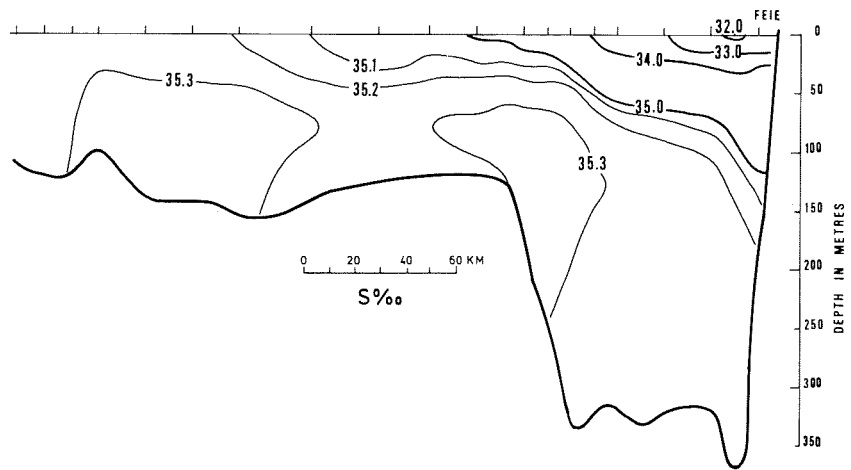
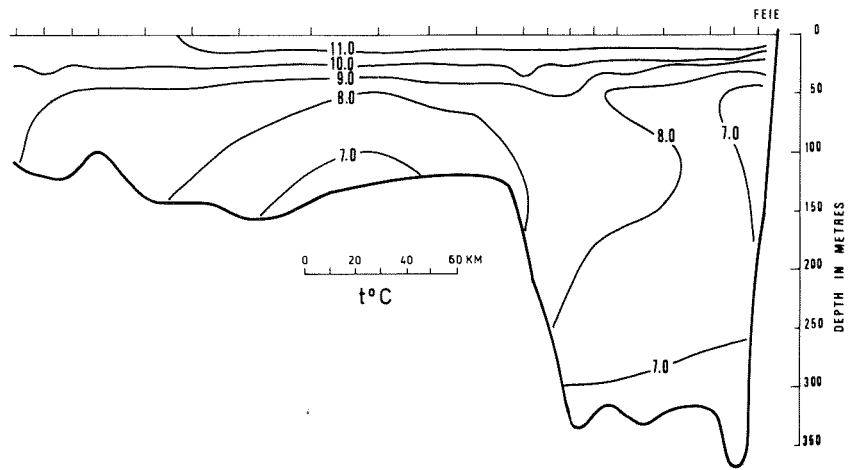

Fig. 2. Antall observasjonsdatoer i fem dagers intervall. [Number dates of observations in intervals of five days].

# A T L A S

Vertikale snitt. Vertical sections.	Side. Page
Snitt I. Section I : Feie - Shetland	8-9
Snitt II. Section II : Slåtterøy - Shetland	10-11
Snitt III. Section III : Utsira - Orkney	12-13
Snitt IV. Section IV : Jærens Rev - SW	14-15
Snitt V. Section V : Egerøy - SW	16-17
Snitt VI. Section VI : Lista - SW	18-19
Snitt VII. Section VII : Lindesnes - SSW	20-21
Snitt VIII. Section VIII : Oksøy - Hanstholm	22-24
Snitt IX. Section IX : Torungen - Hirtshals	25-27
Snitt X. Section X : Hanstholm - Aberdeen	28-29
Horisontale kart. Map diagrams.	
Overflaten. Sea surface.	30-32
50 m dyp. 50 m depth.	33-35
Bunn. Bottom.	36-37



Snitt I Section I



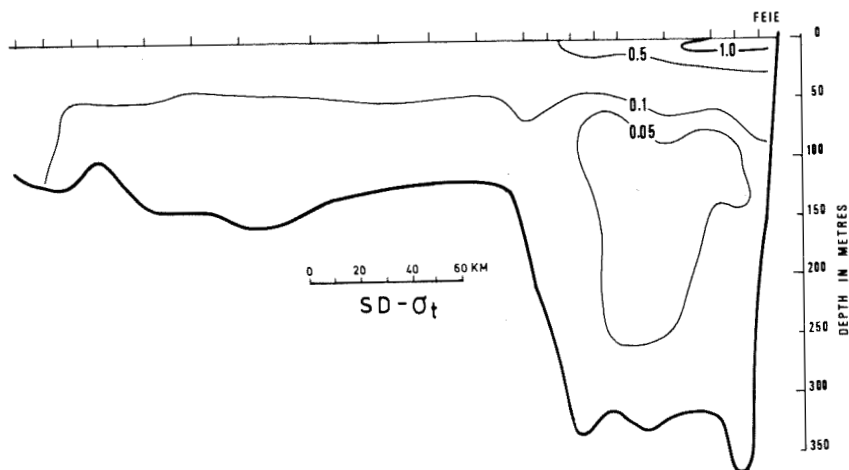
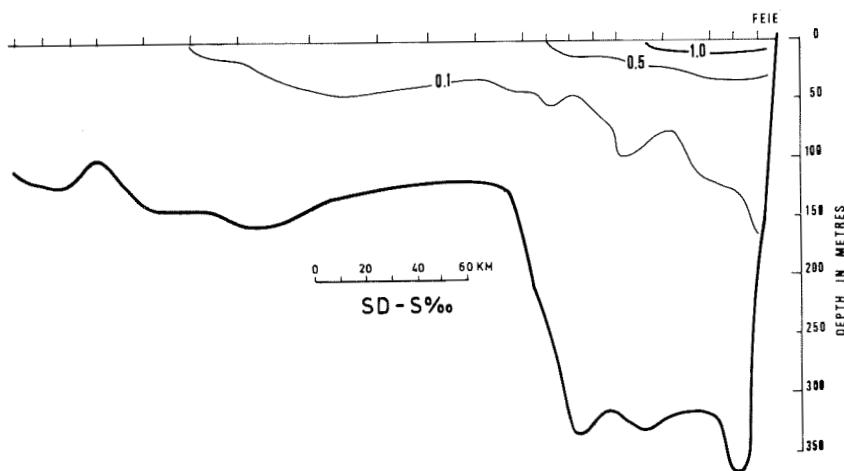
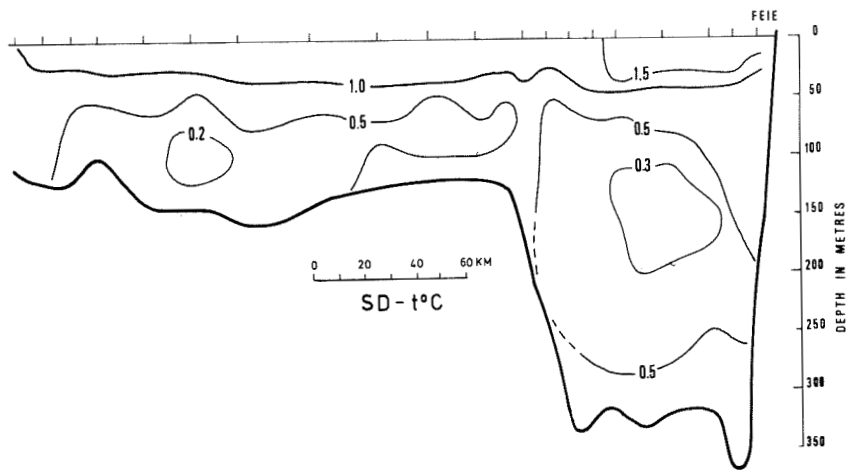

Snitt I Section I

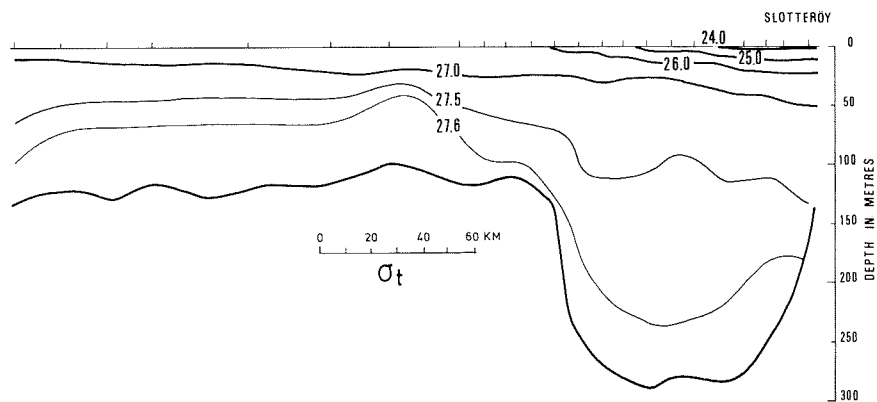
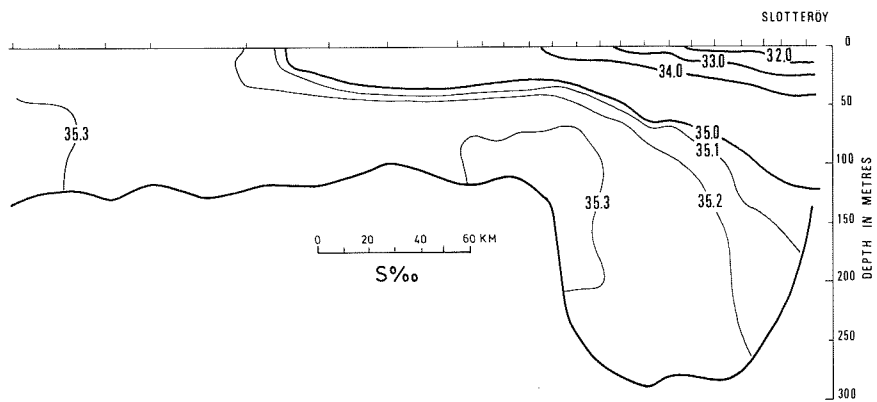
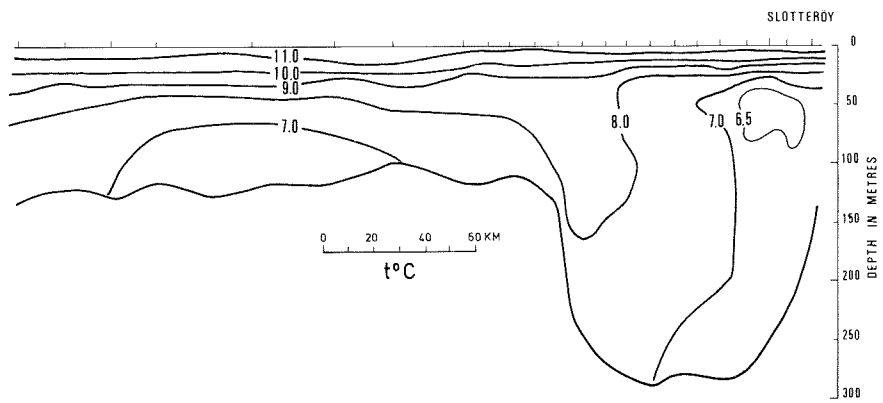

Snitt II Section II

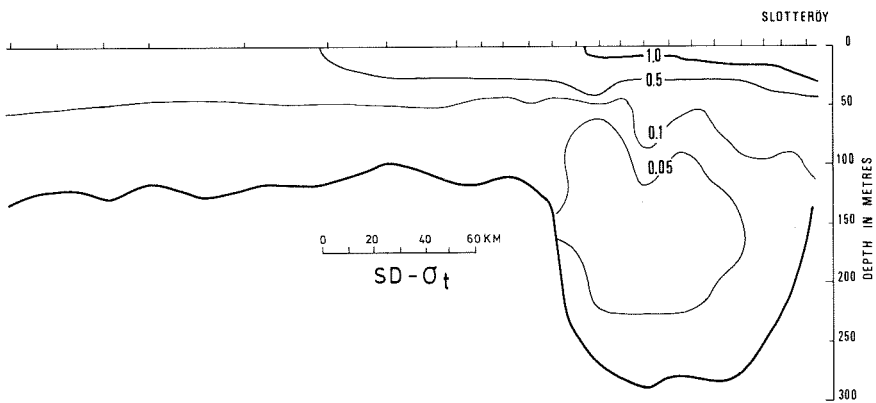
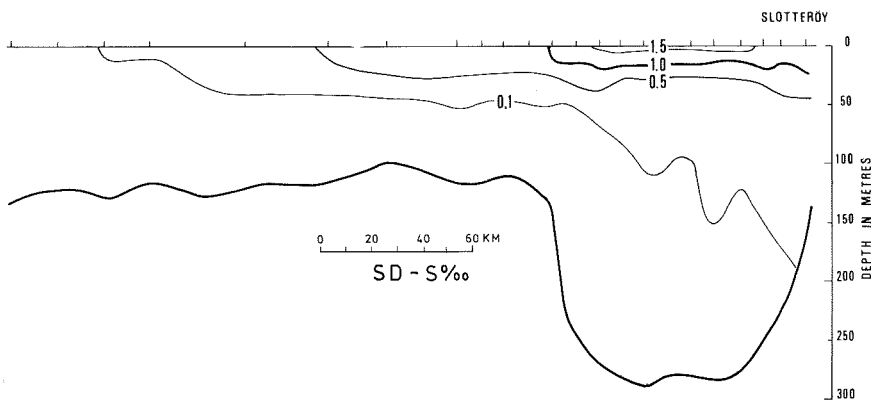
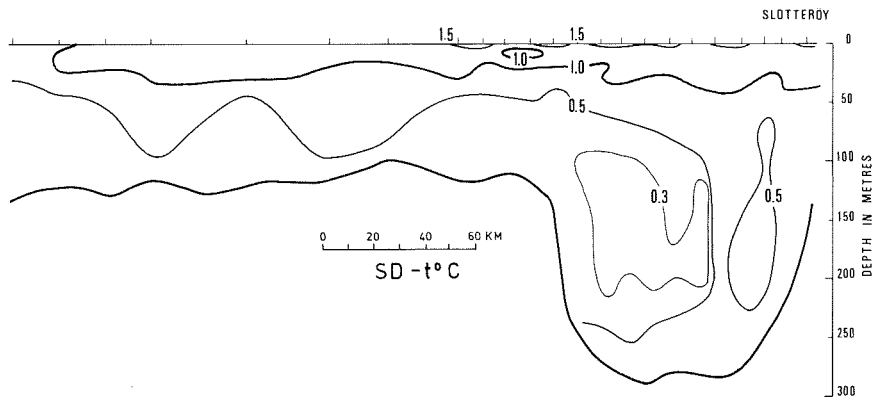

Snitt II Section II

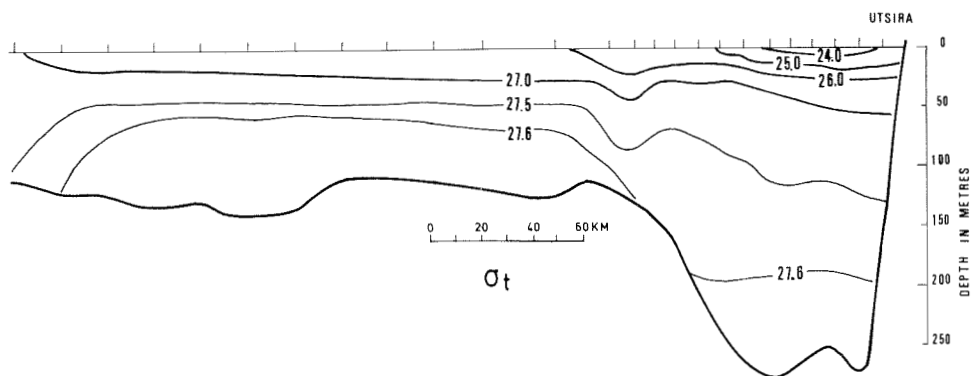
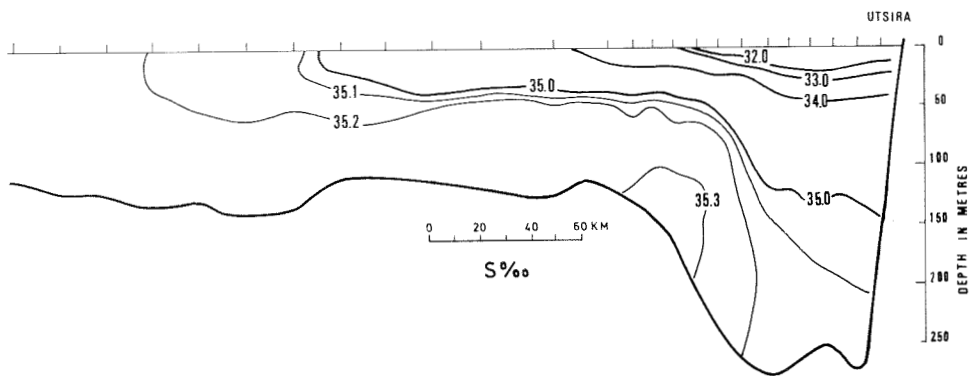
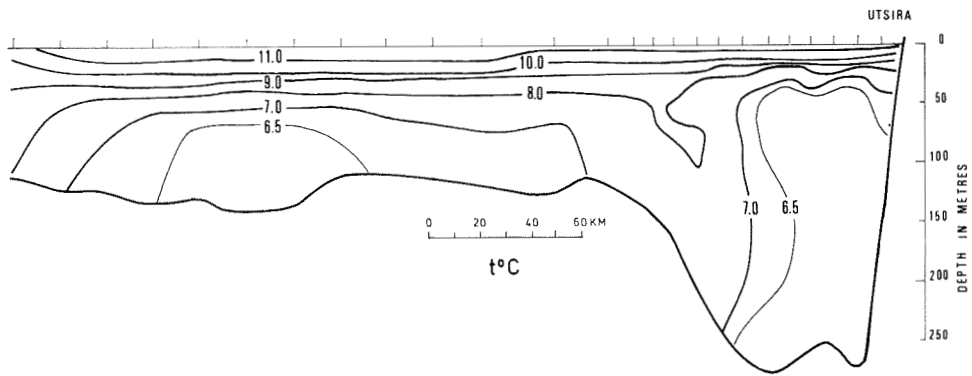

Snitt III Section III

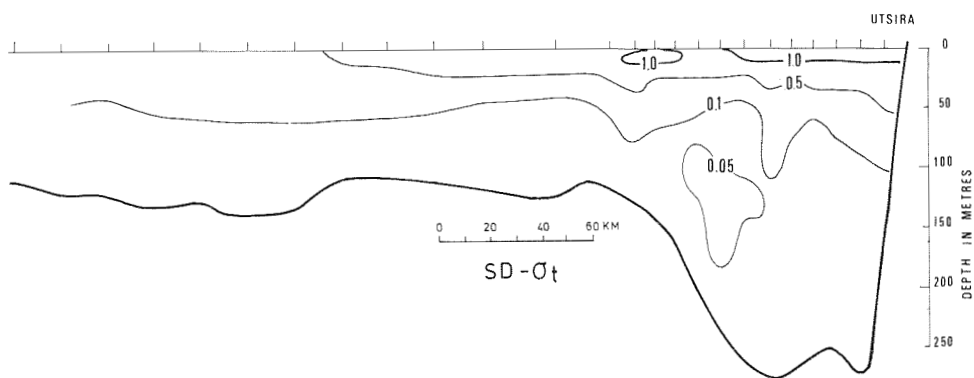
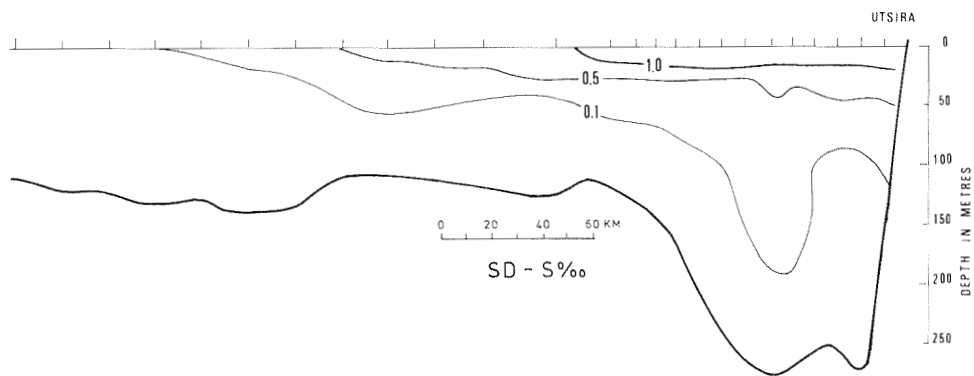
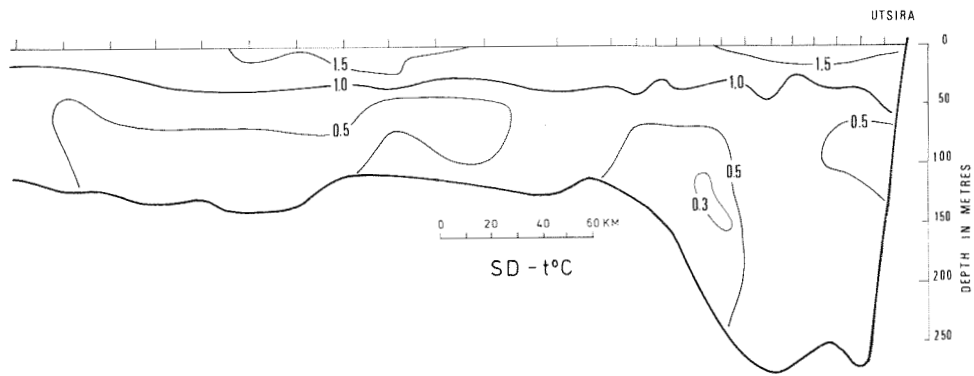

Snitt III Section III

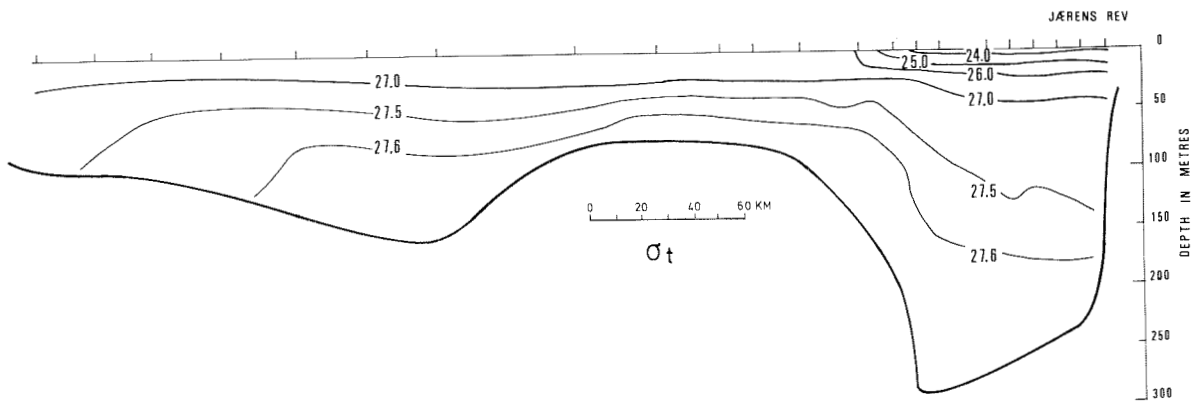
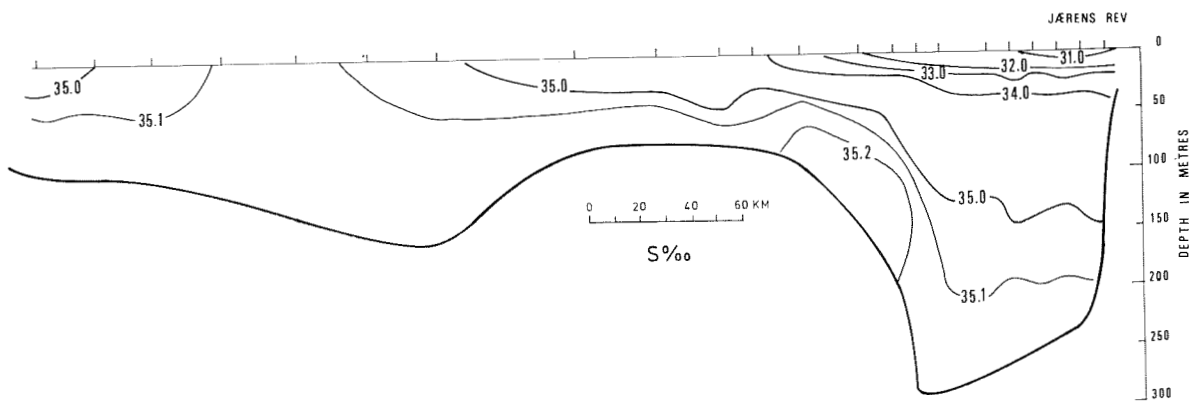
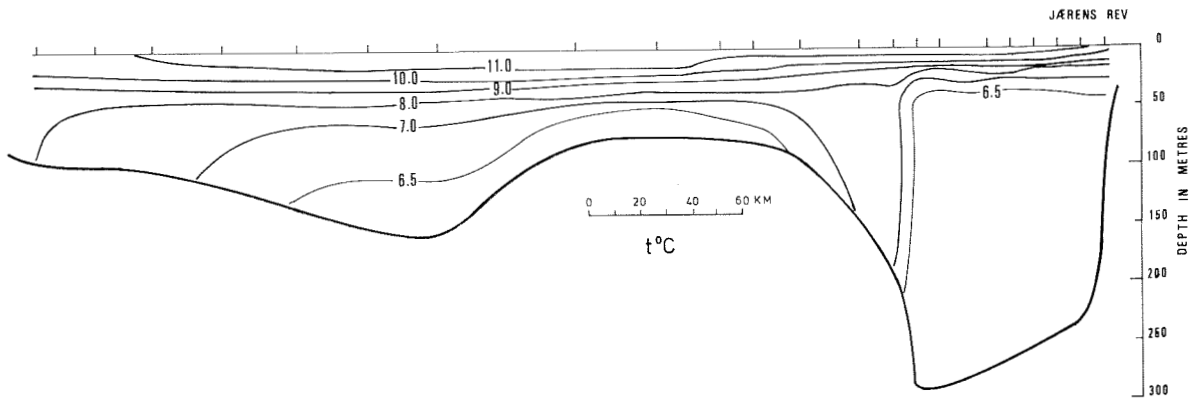

Snitt IV Section IV

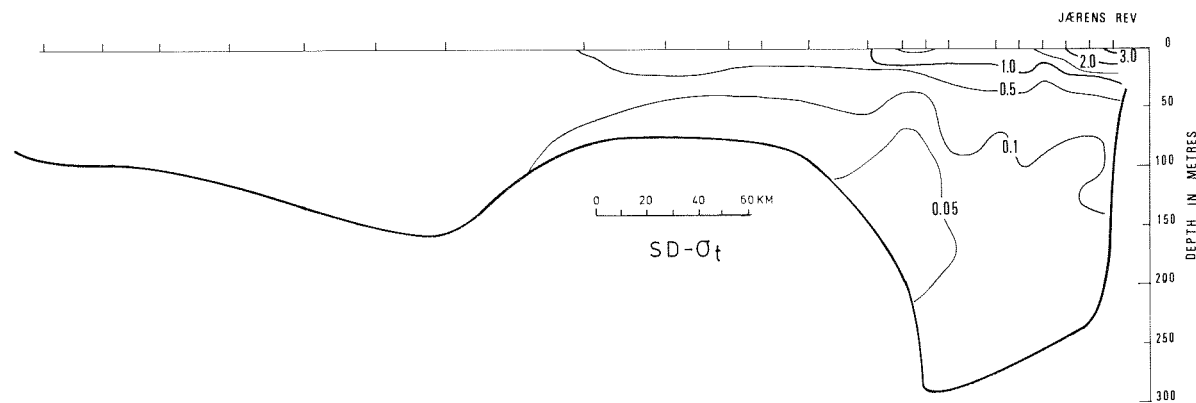
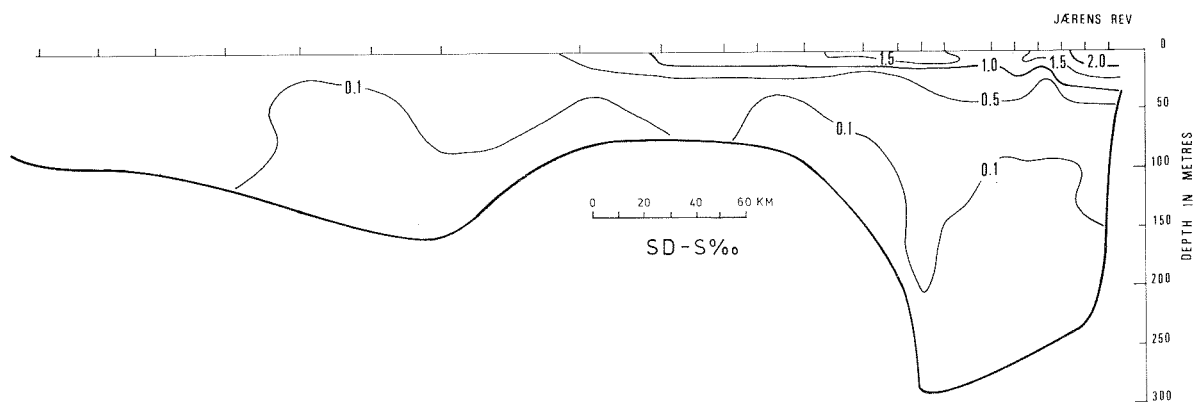
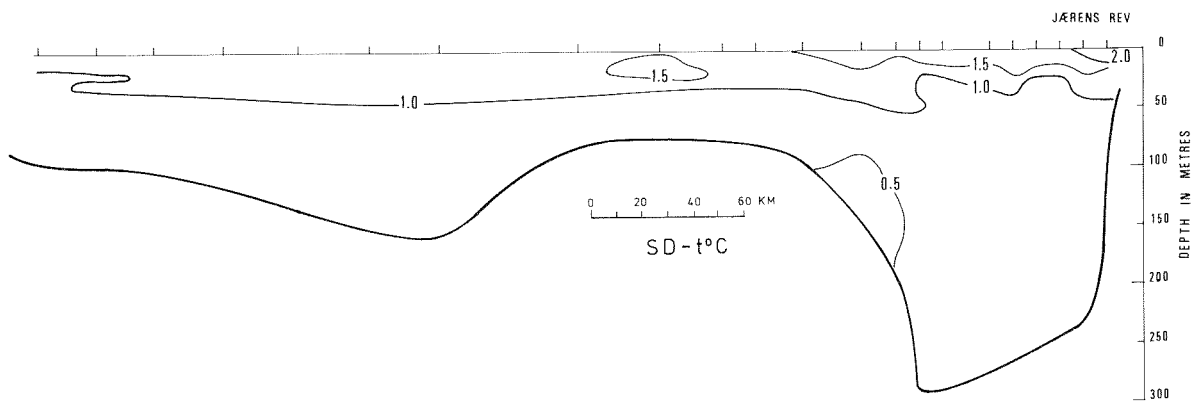

Snitt IV Section IV

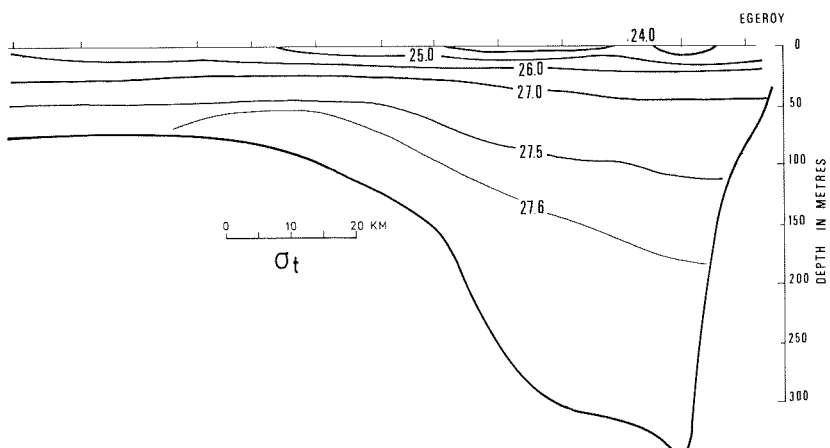
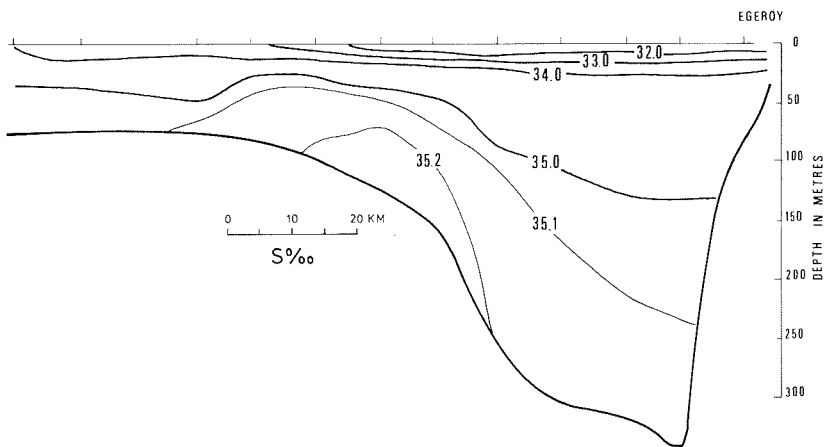
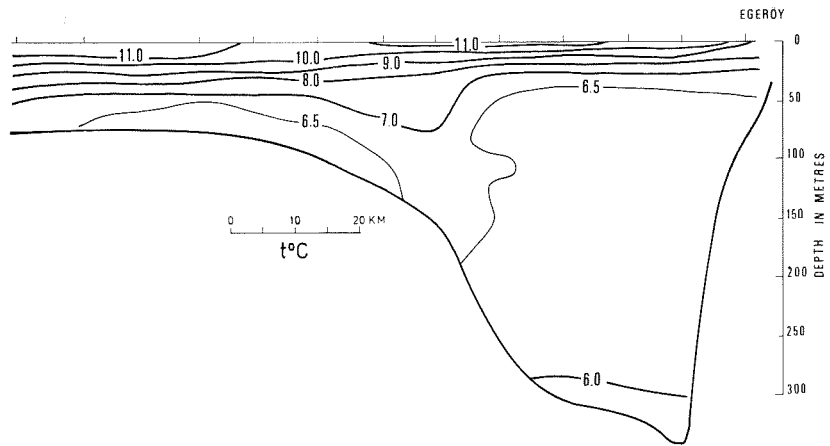

Snitt V Section V



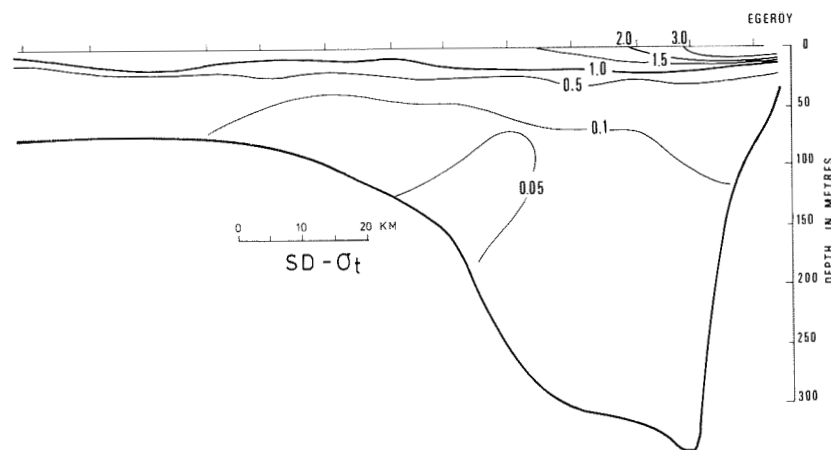
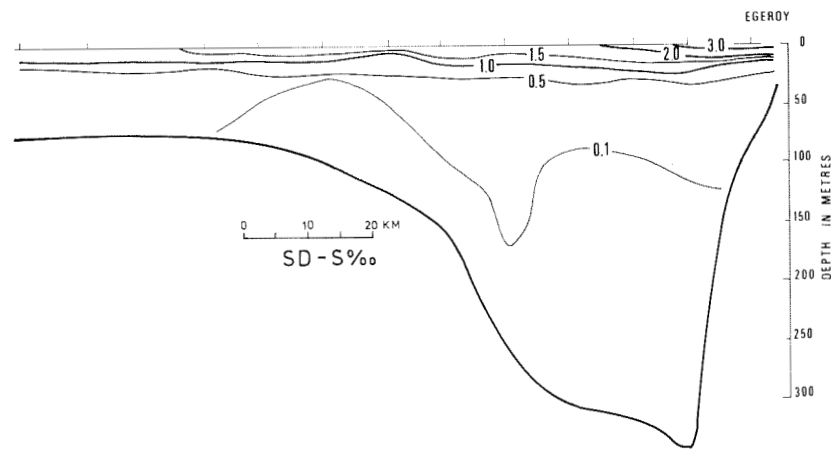
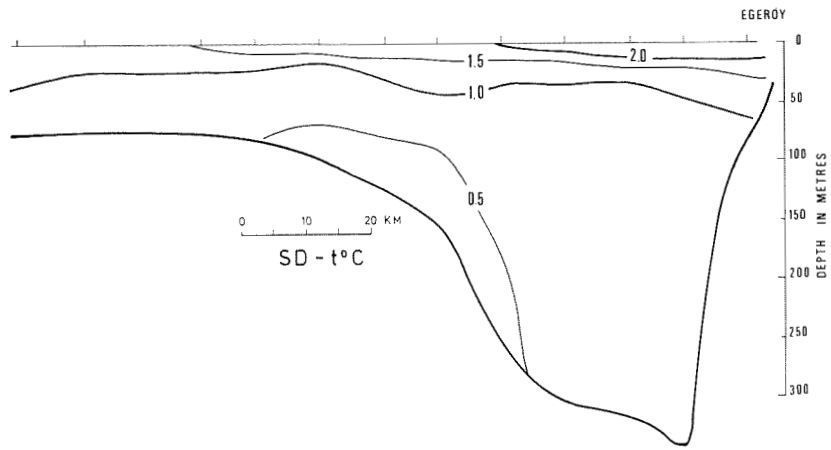

Snitt V Section V

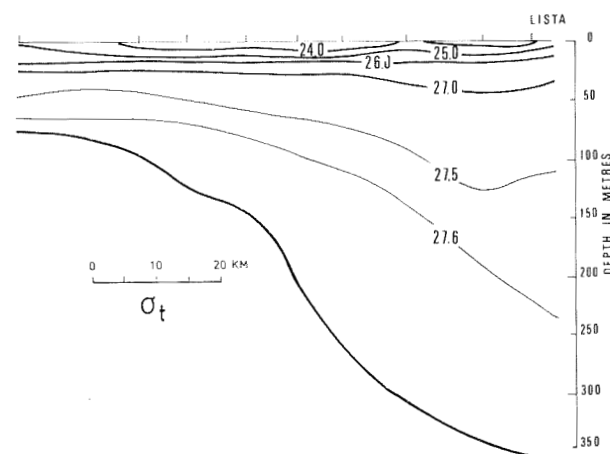
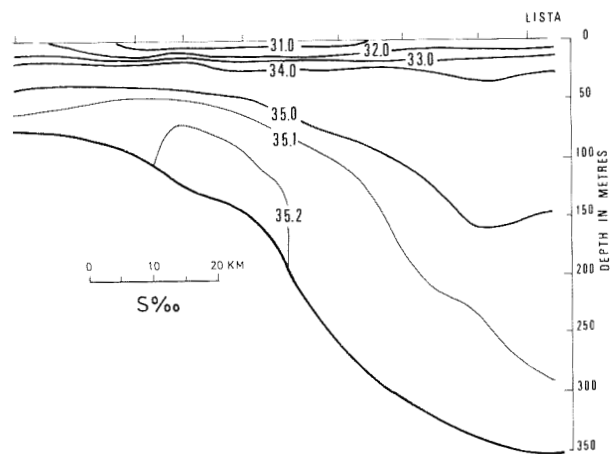
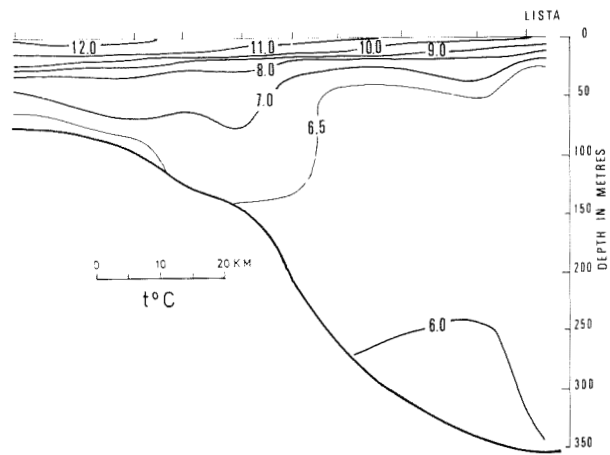

Snitt VI Section VI

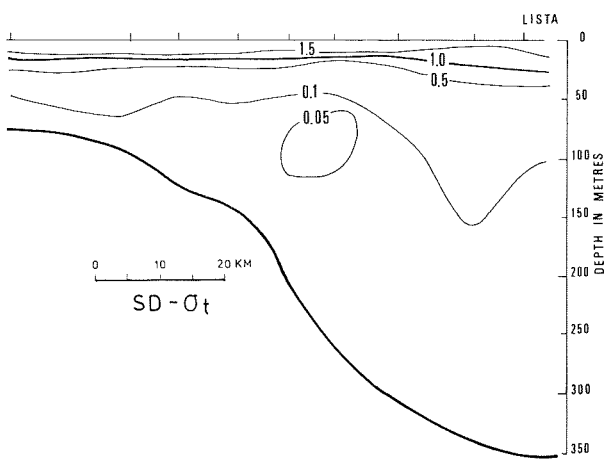
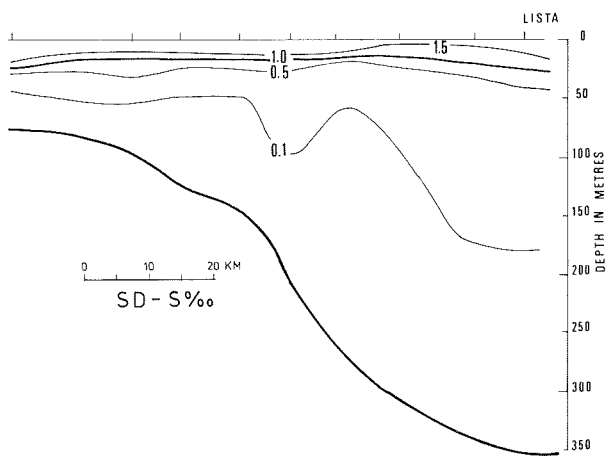
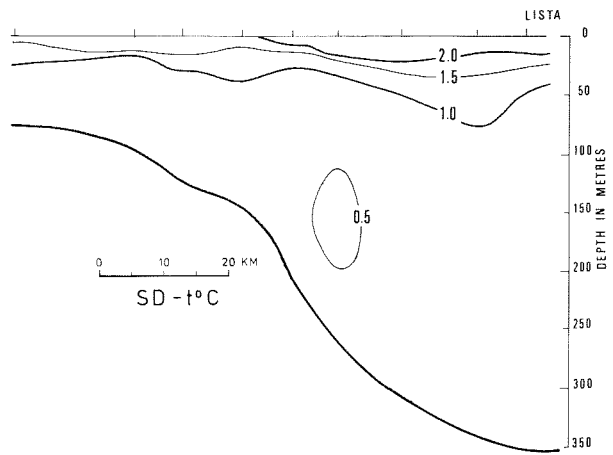

Snitt VI Section VI

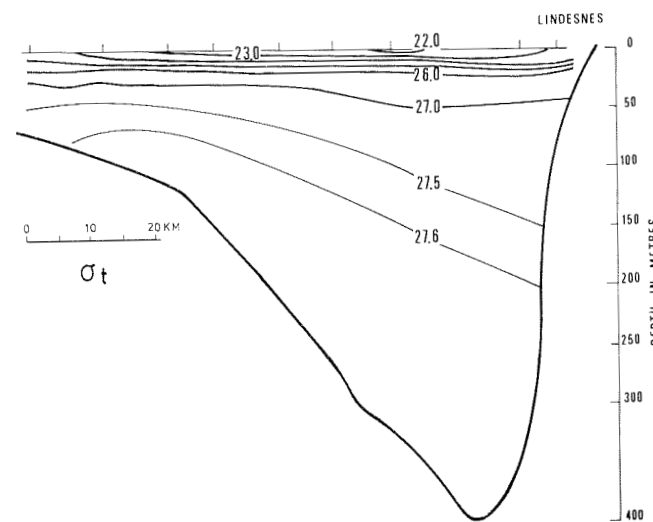
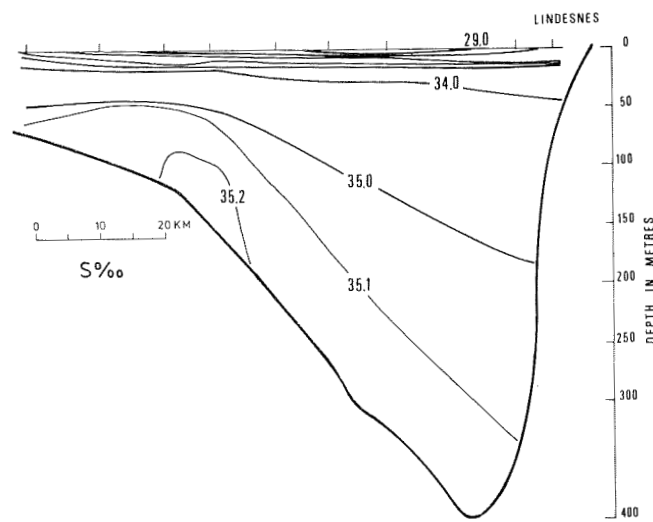
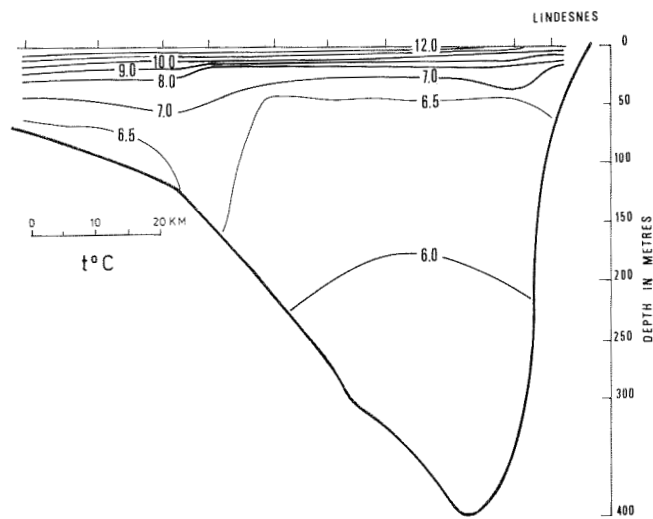

Snitt VII Section VII

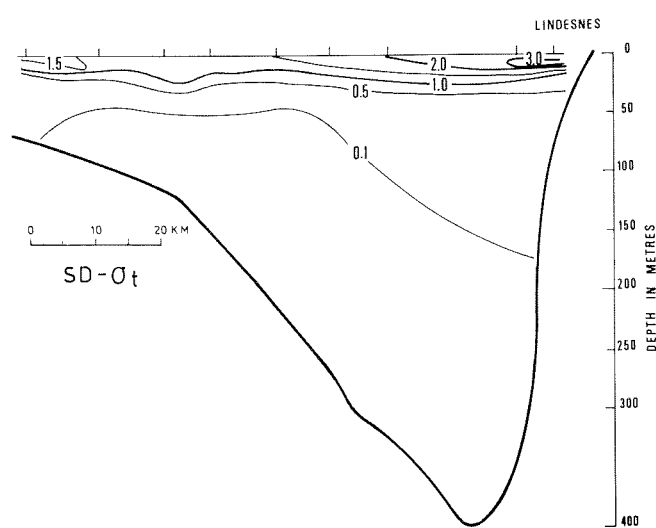
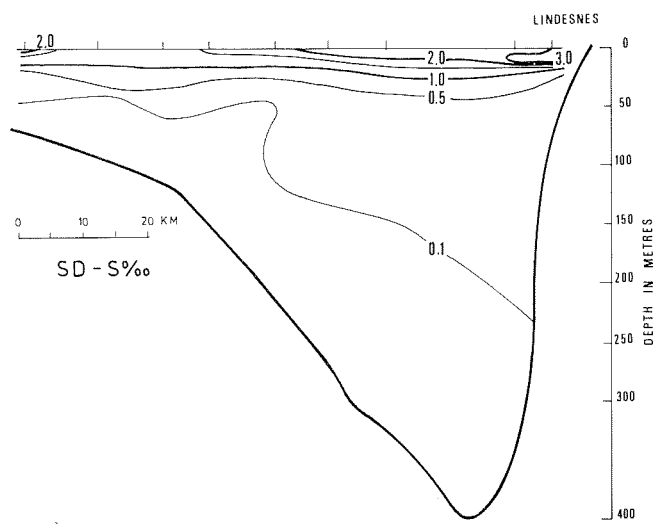
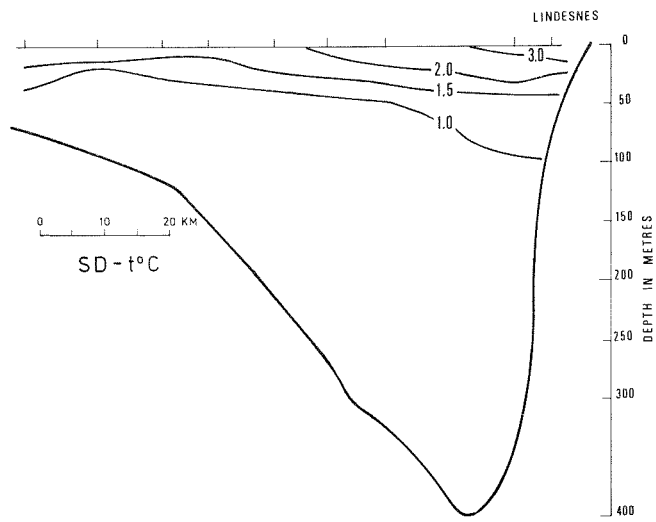

Snitt VII Section VII

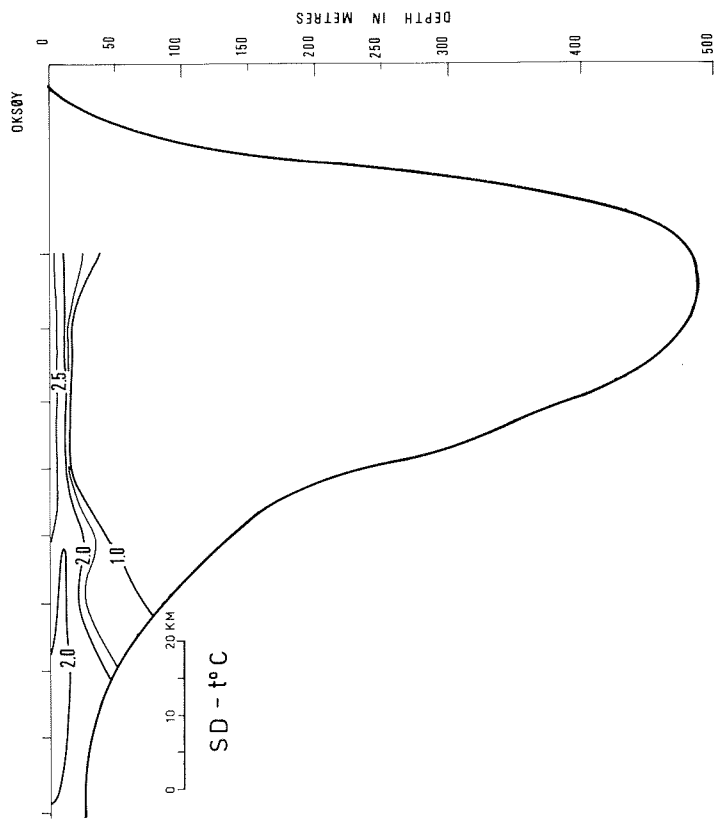

Snitt VIII Section VIII

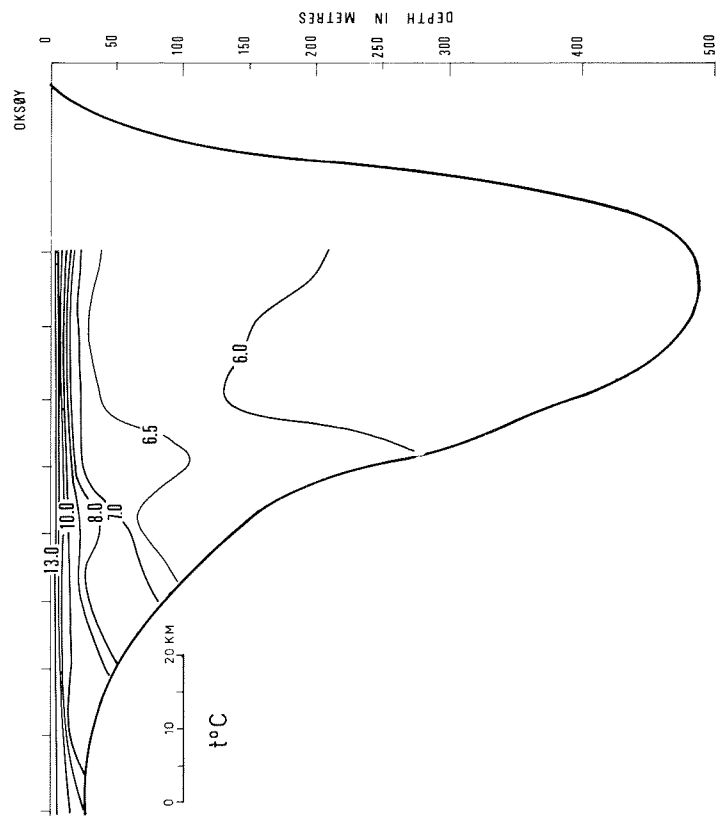

Snitt VIII Section VIII

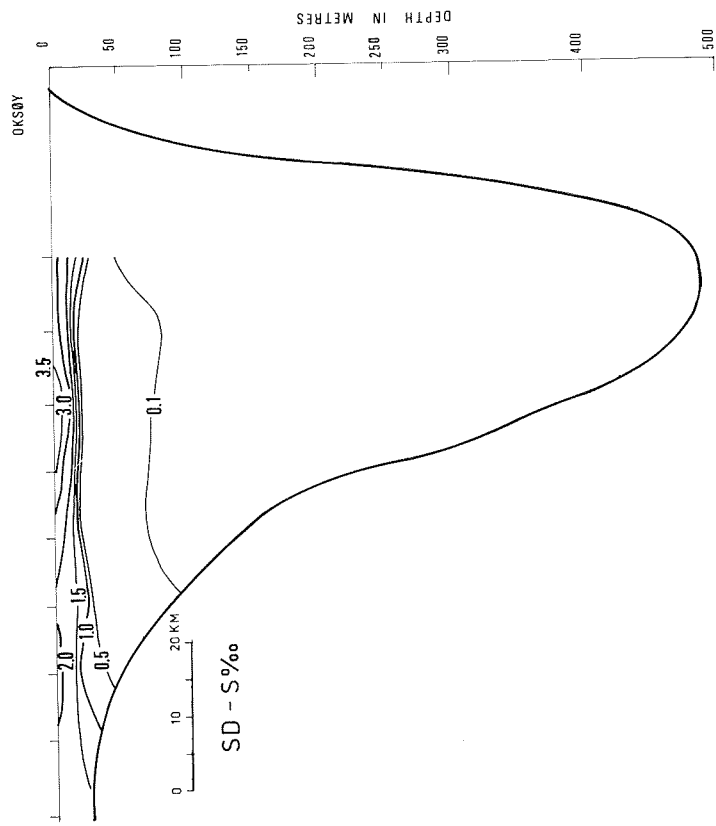

Snitt VIII Section VIII

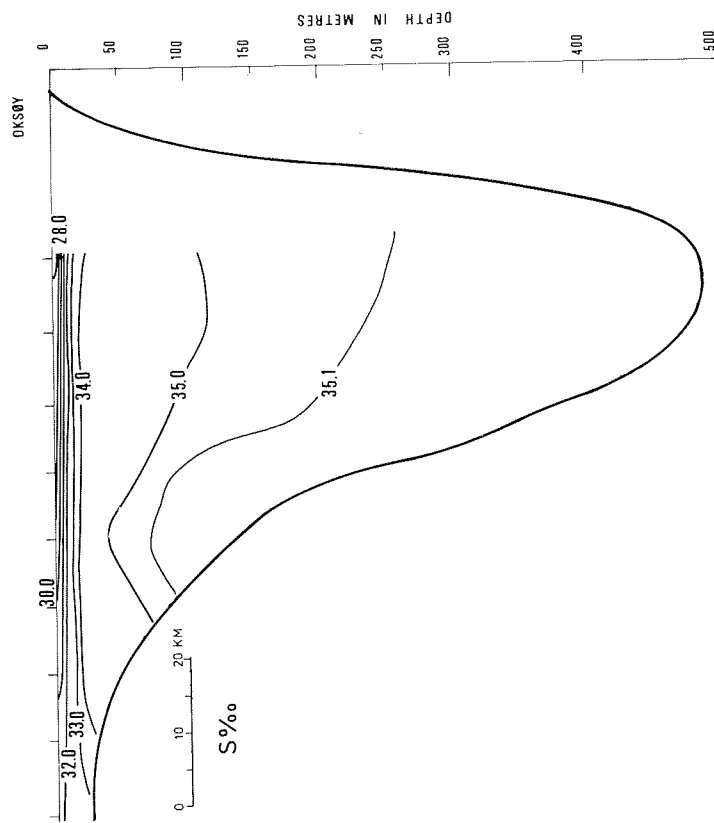

Snitt VIII Section VIII

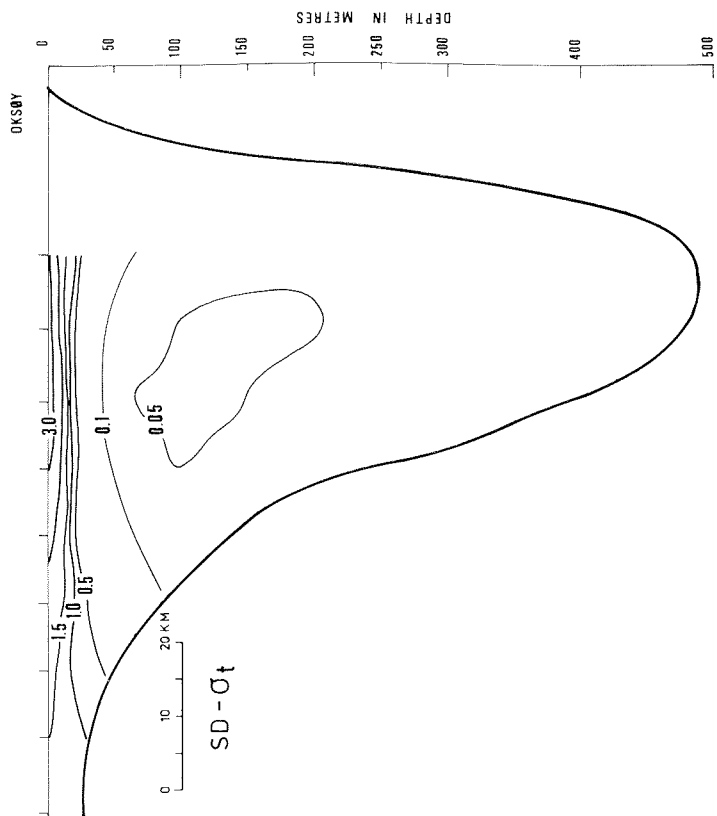

Snitt VIII Section VIII

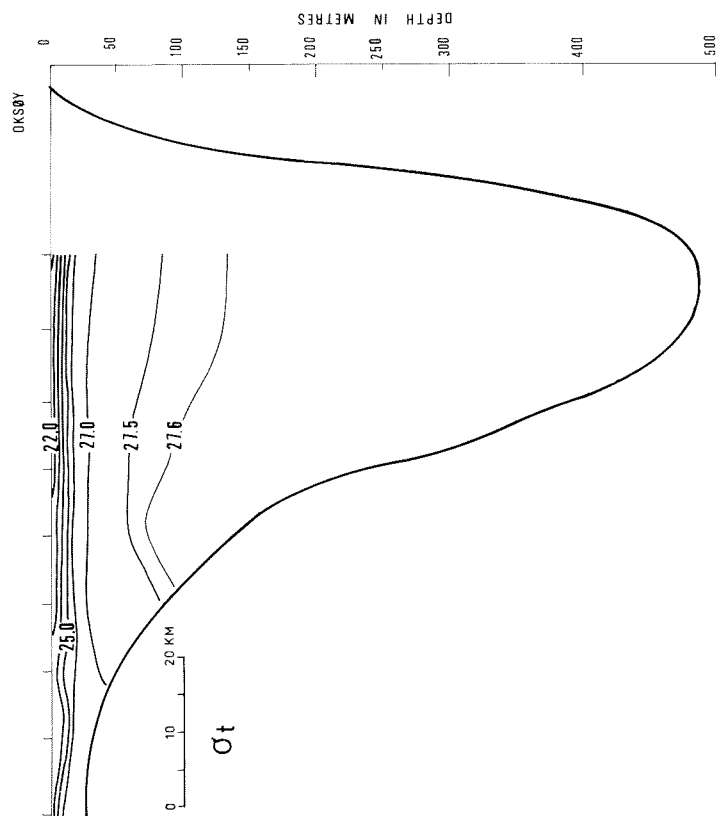

Snitt VIII Section VIII



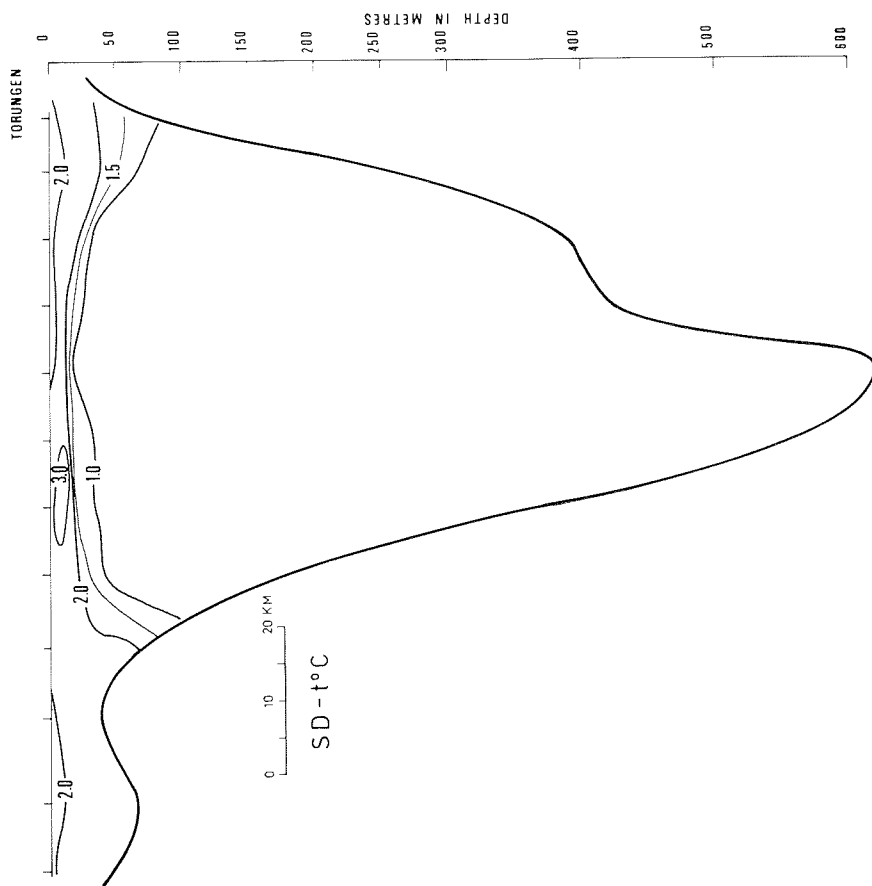

Snitt IX Section IX

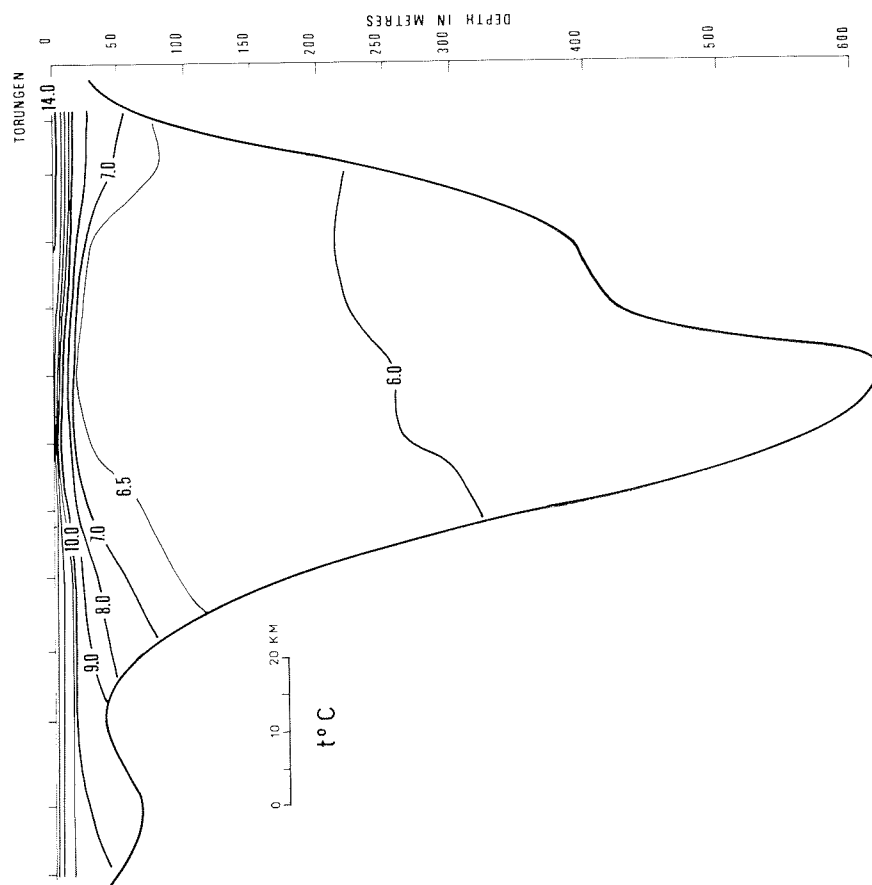

Snitt IX Section IX

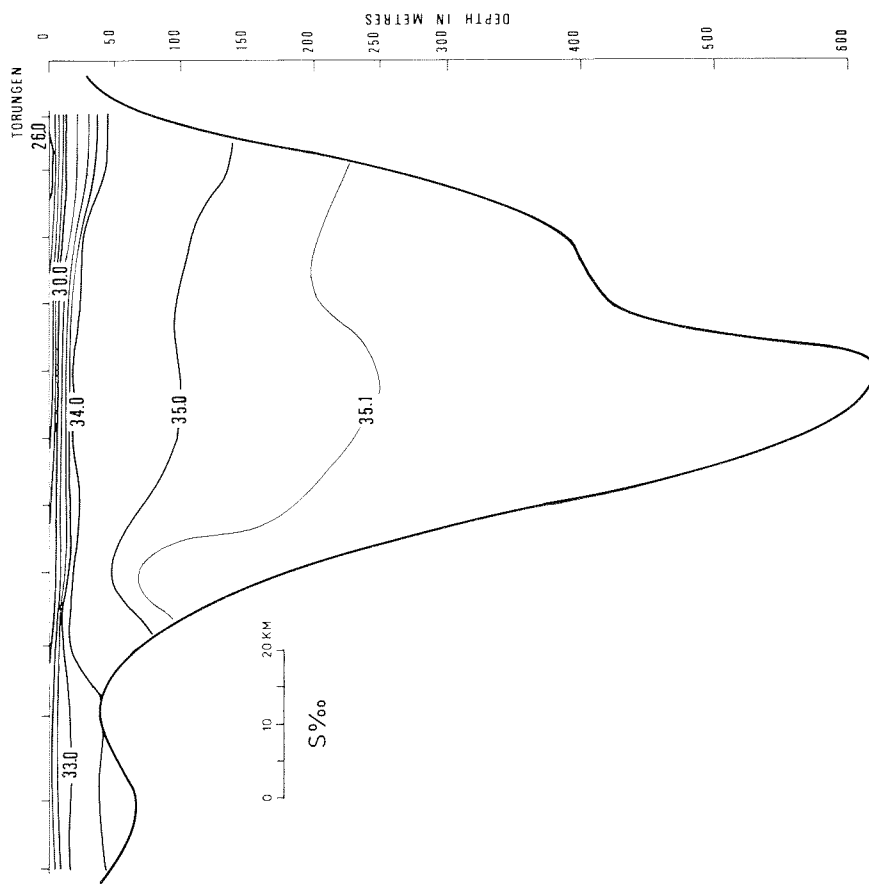

Snitt IX Section IX

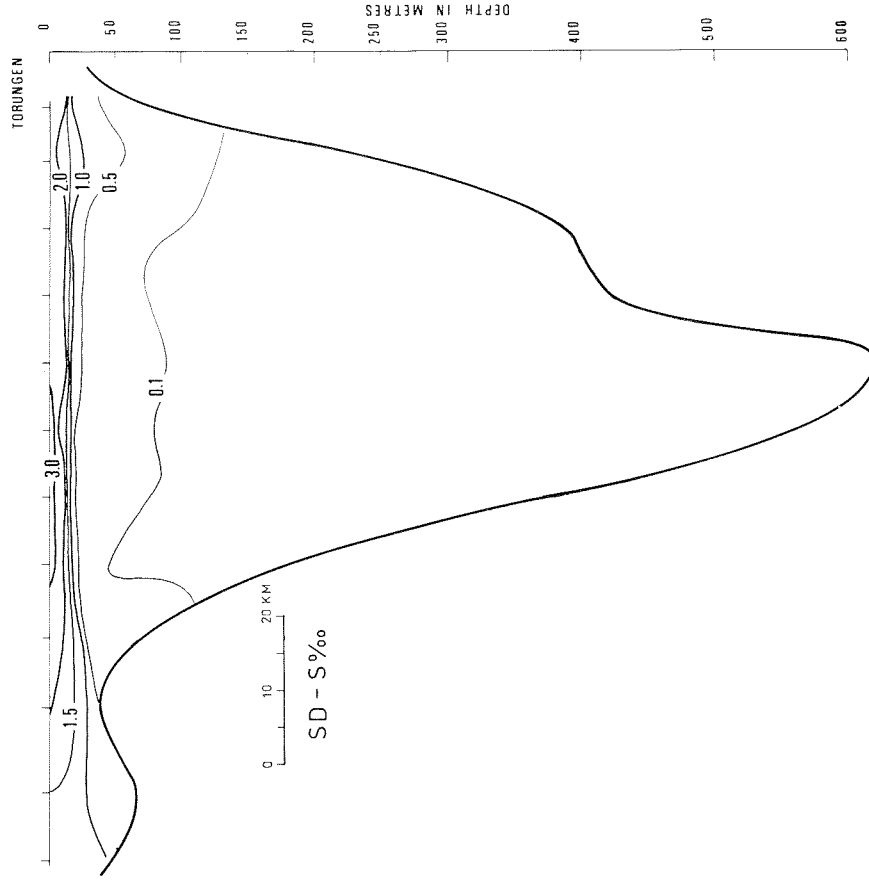

Snitt IX Section IX

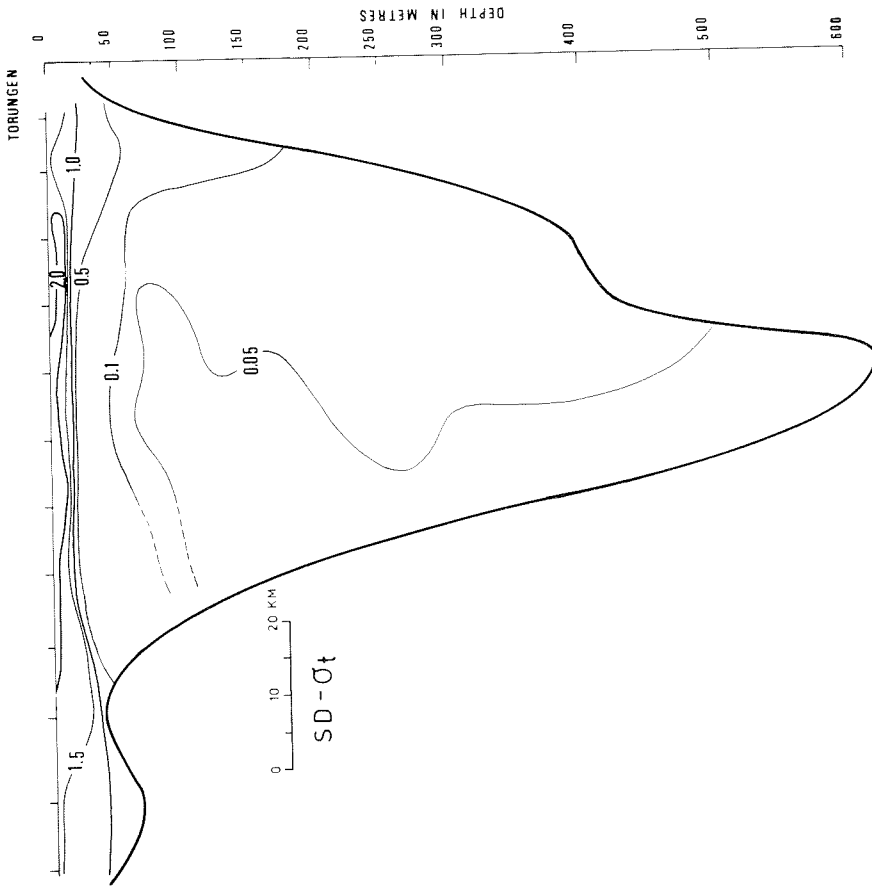

Snitt IX Section IX

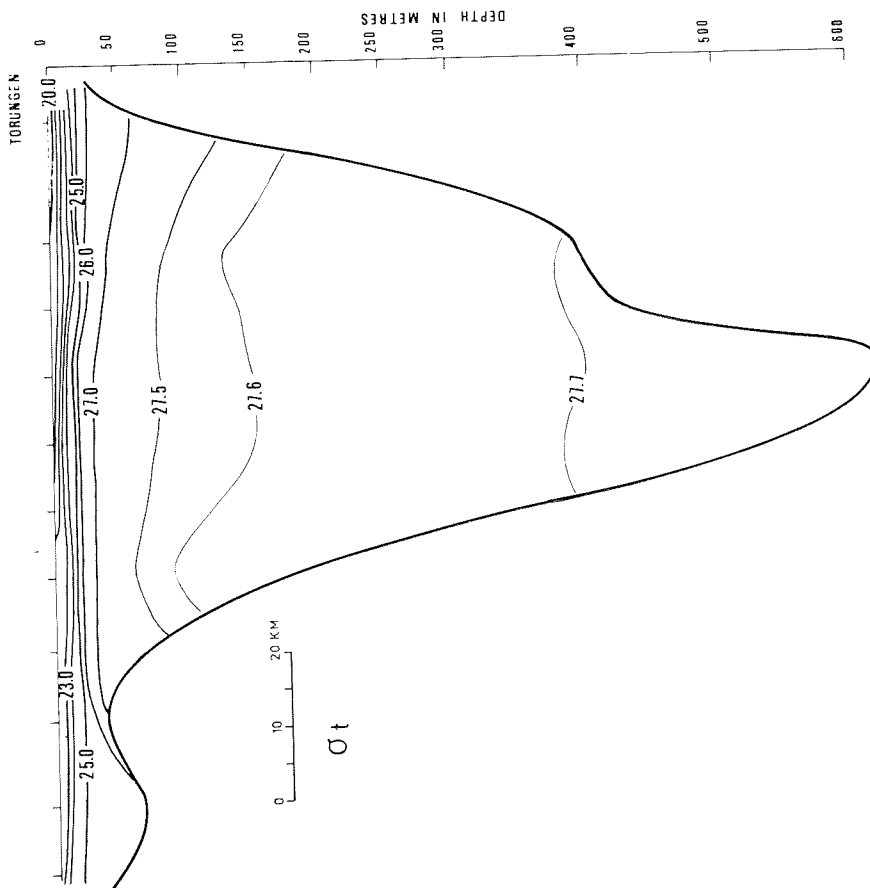

Snitt IX Section IX

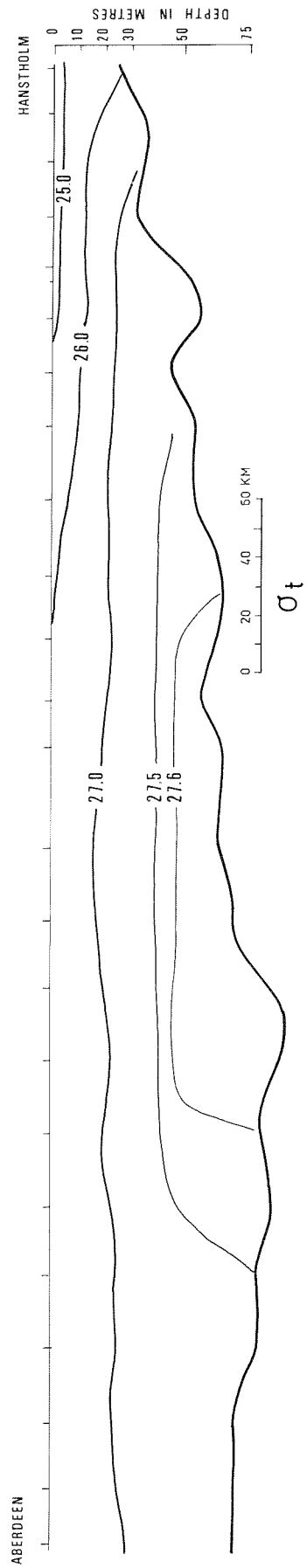
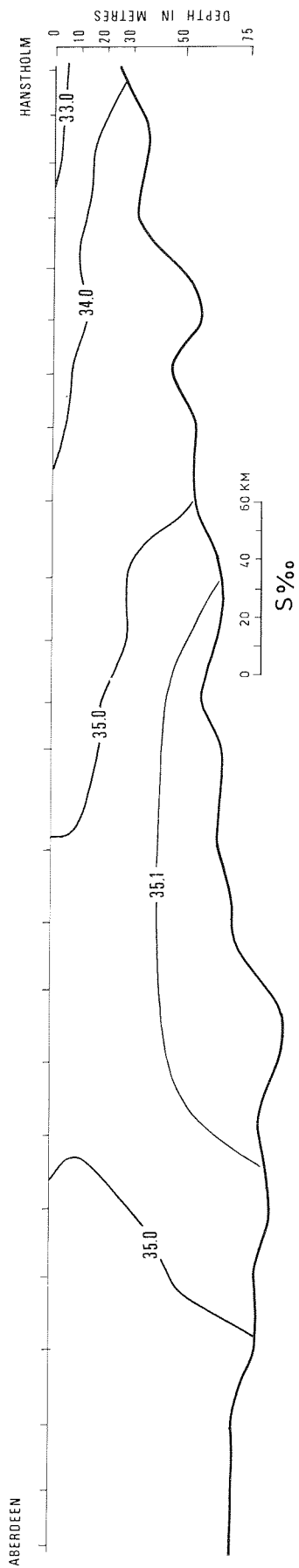
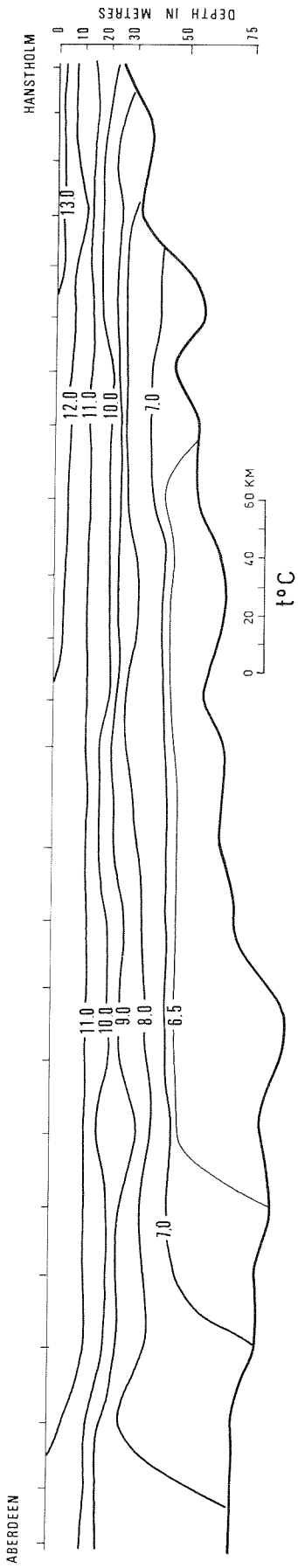

Snitt X Section X

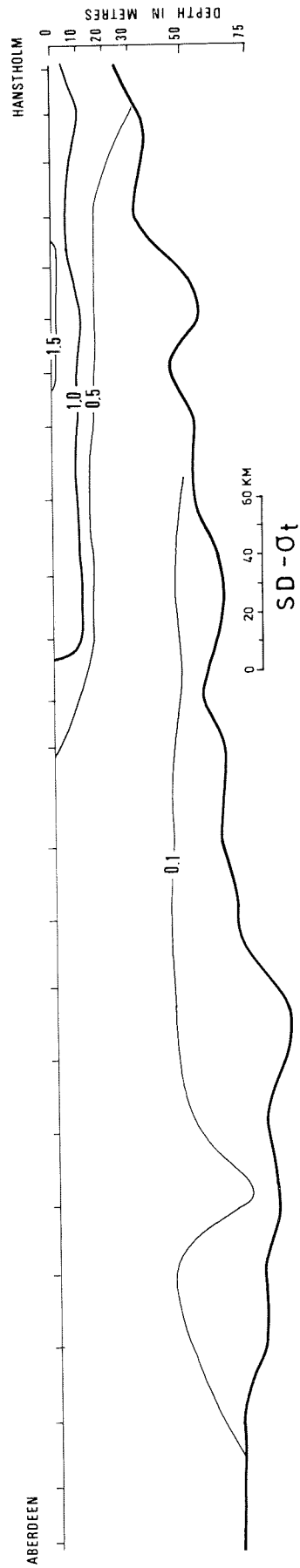
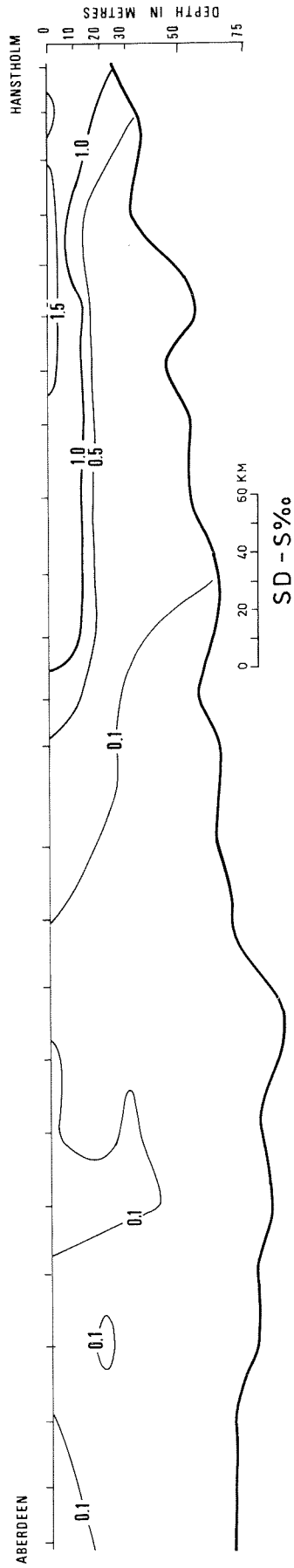
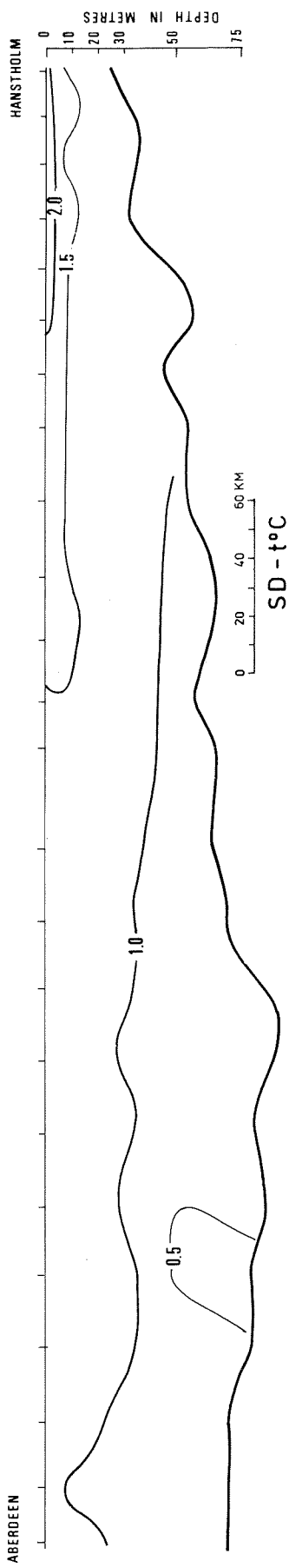

Snitt X Section X

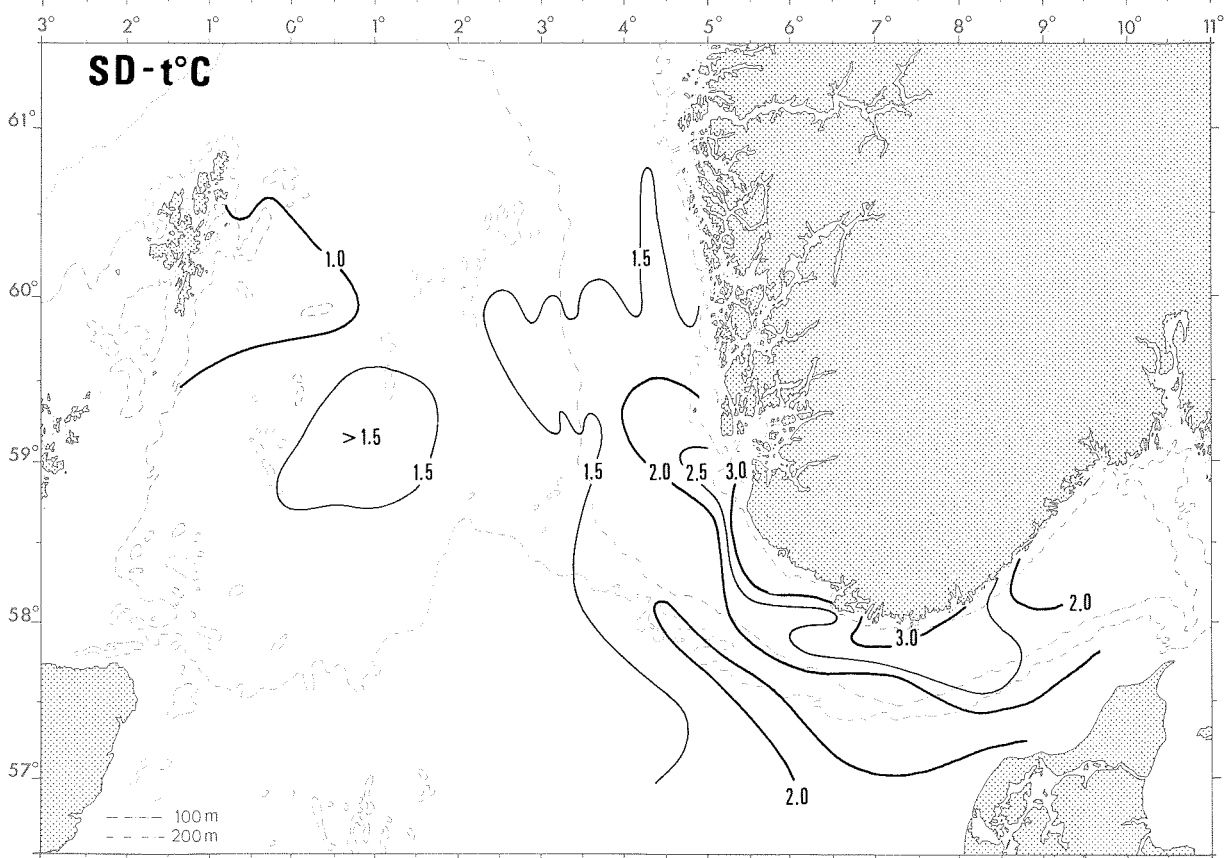
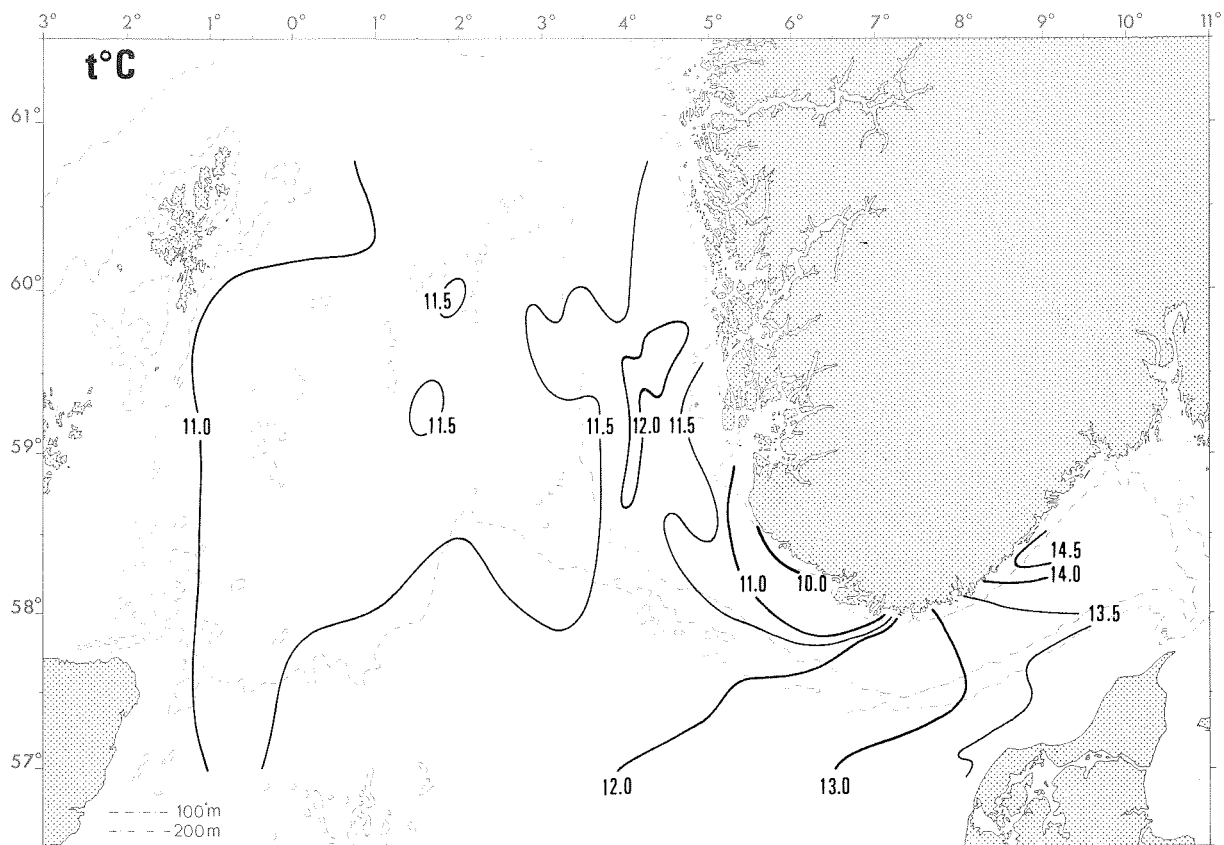

Overflaten Sea surface

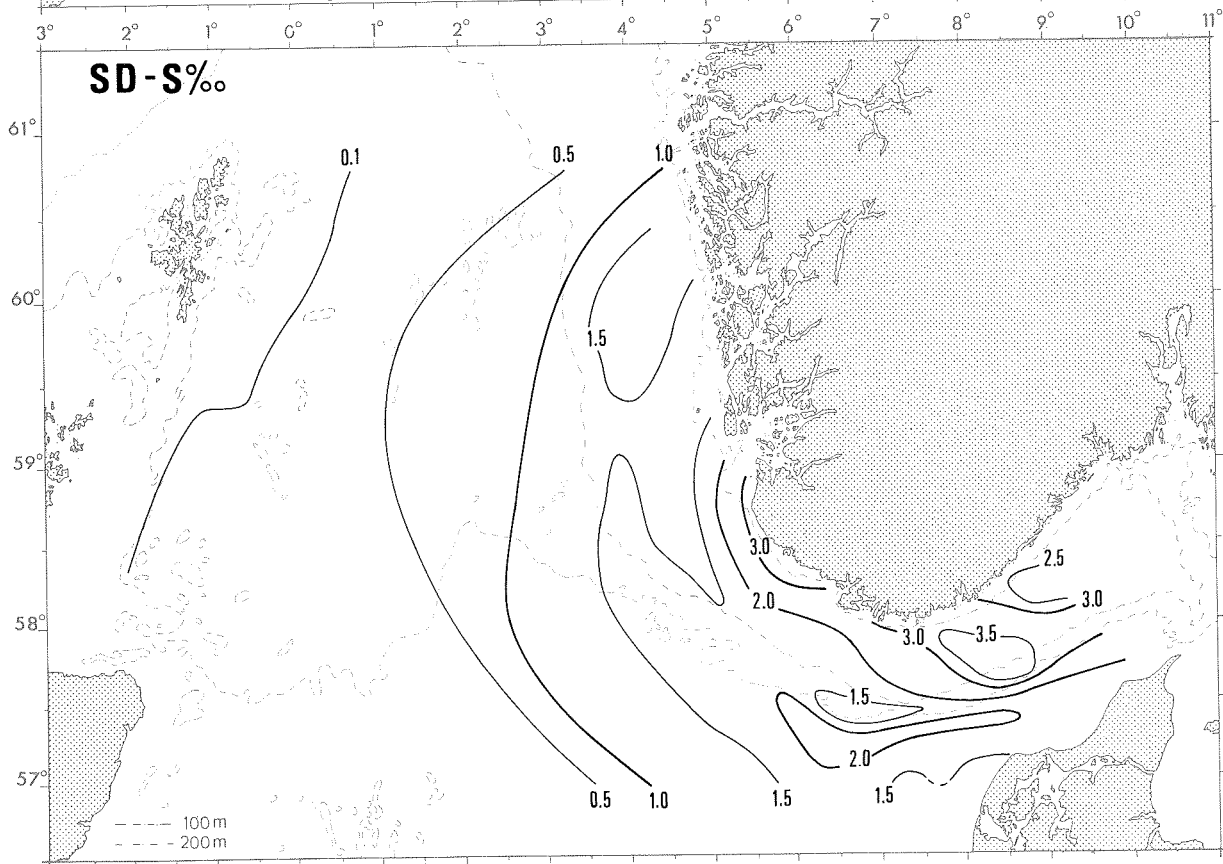
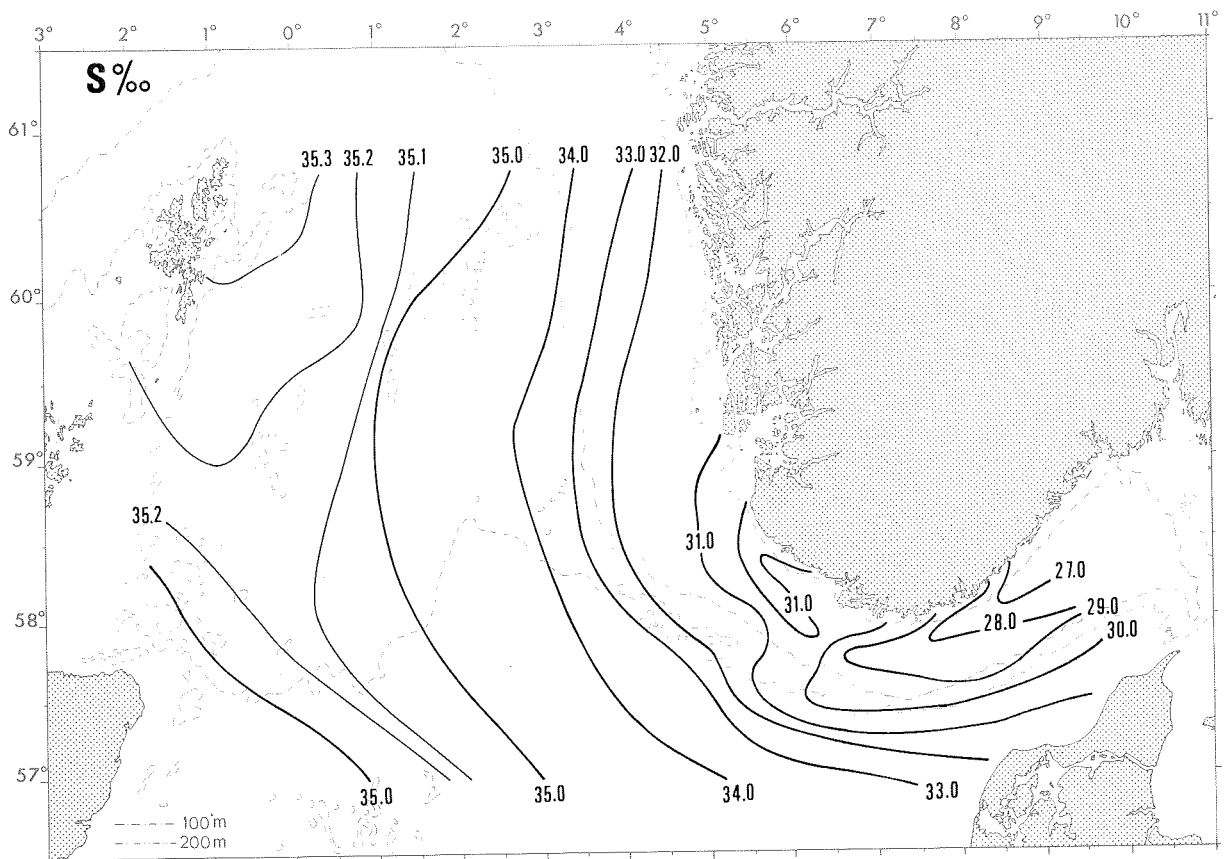

Overflaten Sea surface

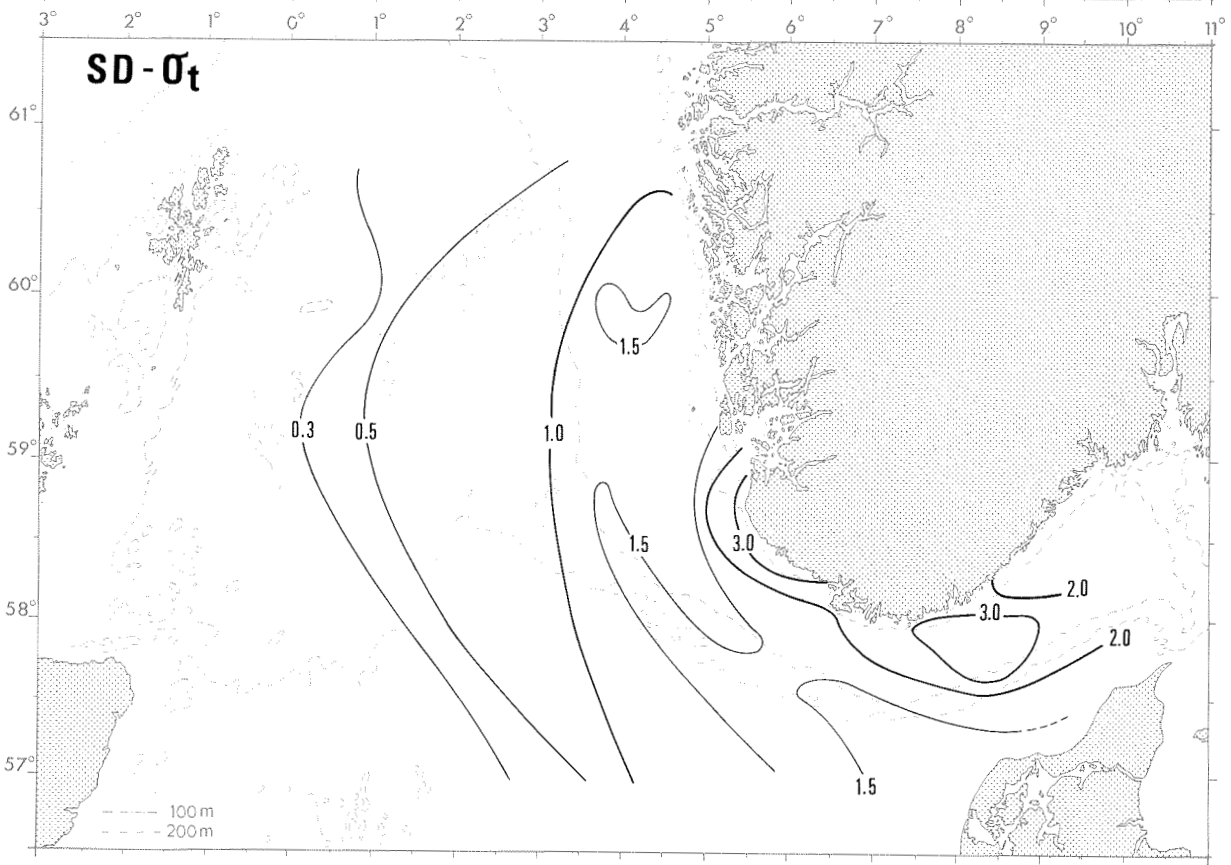
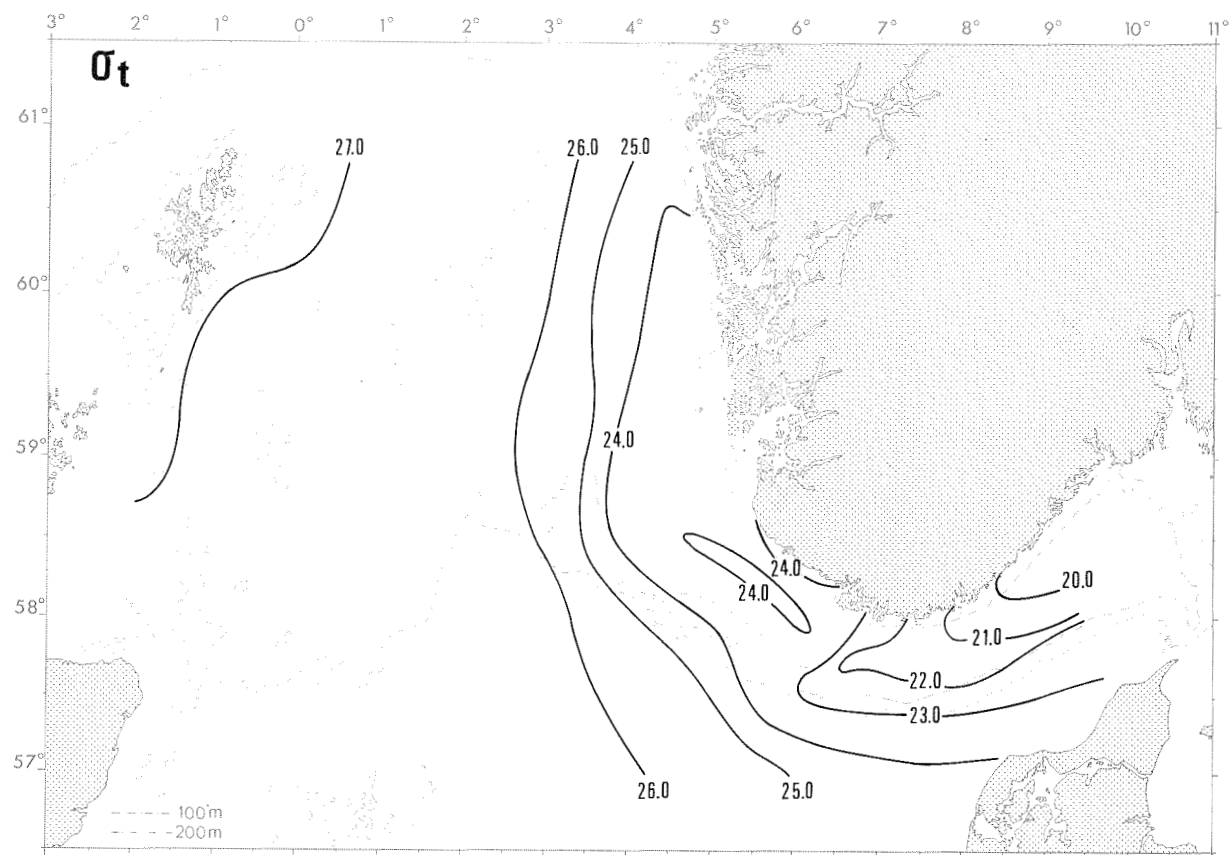

Overflaten Sea surface



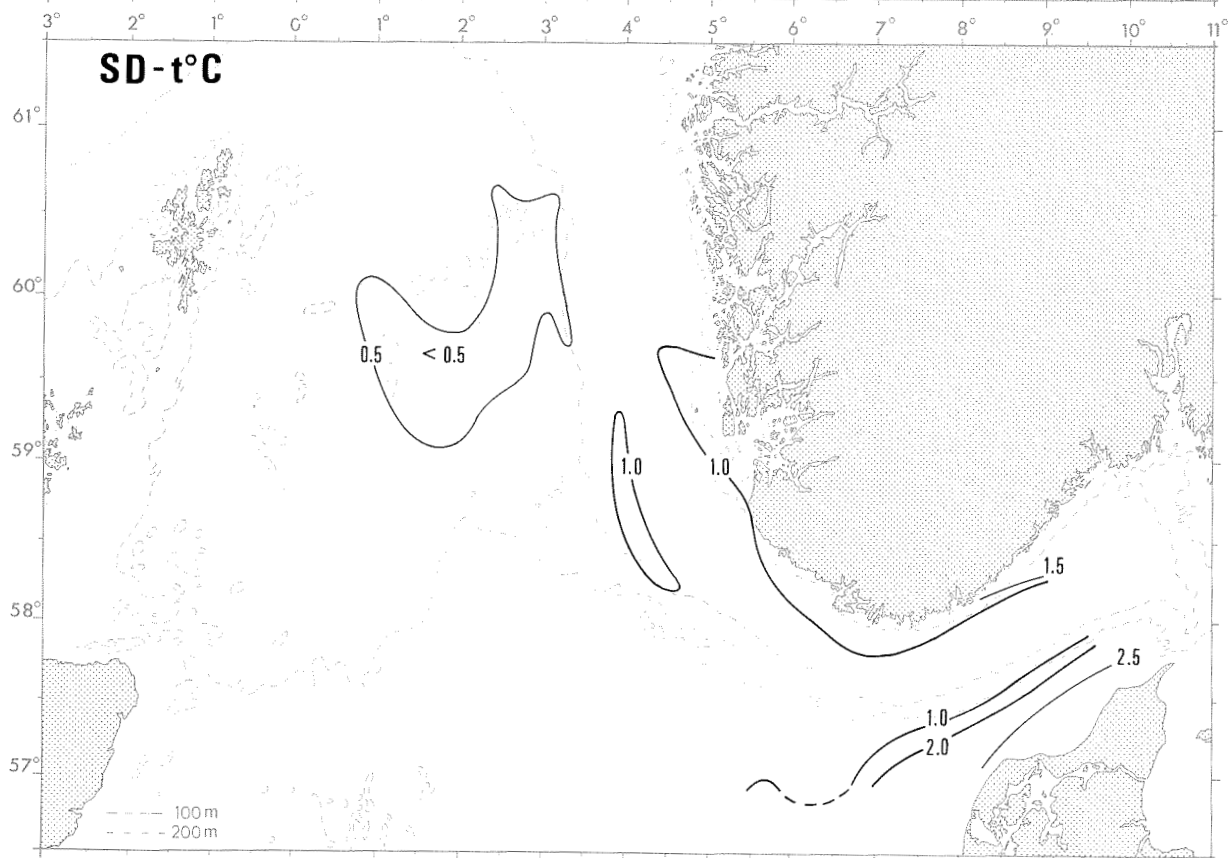
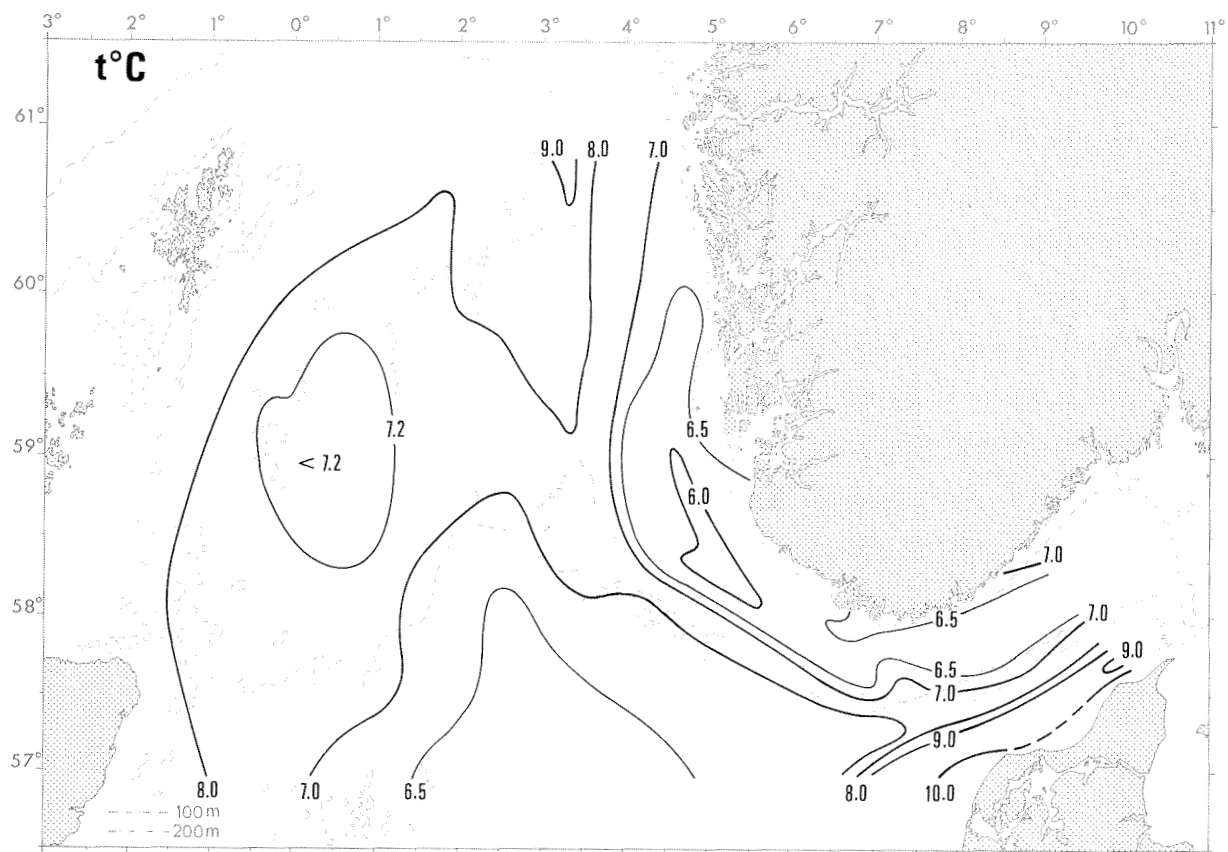

50 m dyp 50 m depth

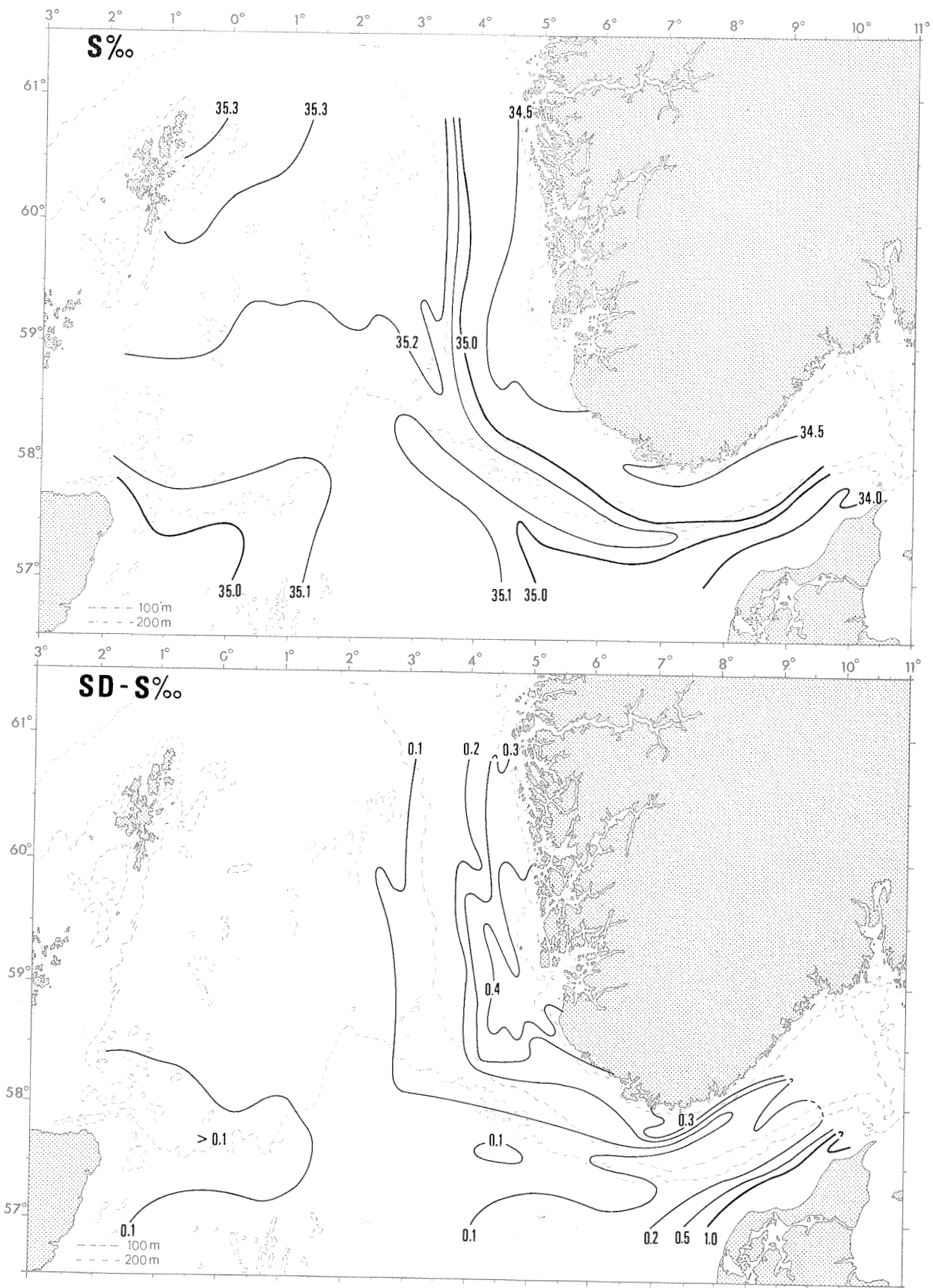

50 m dyp 50 m depth

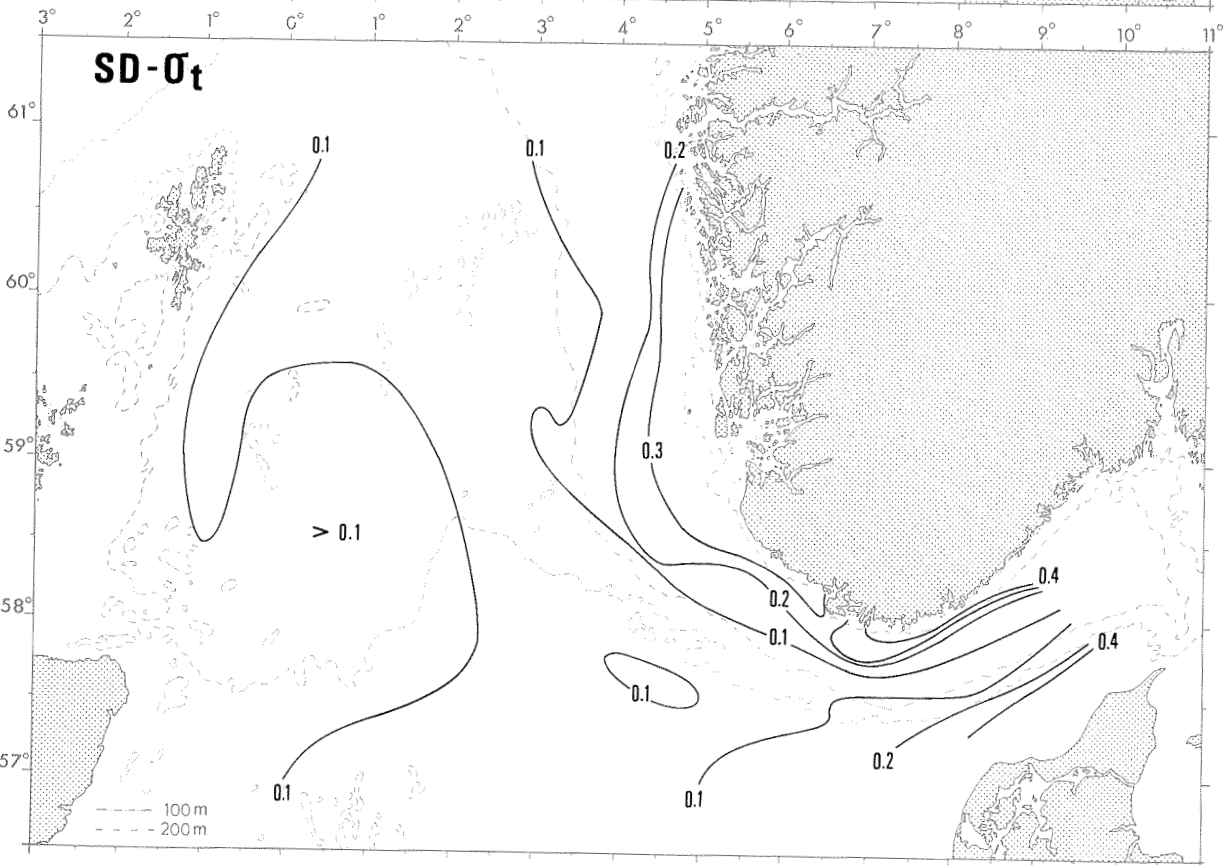
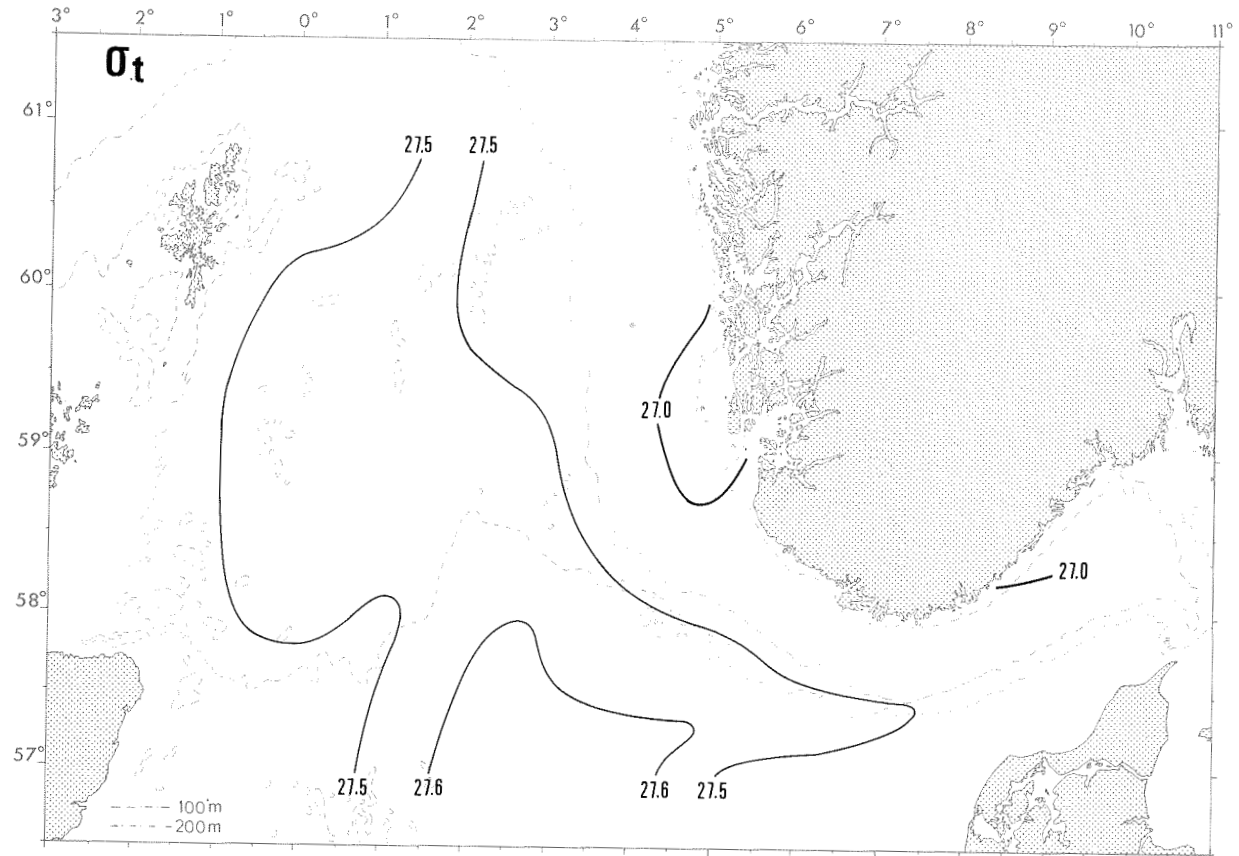

50 m dyp 50 m depth

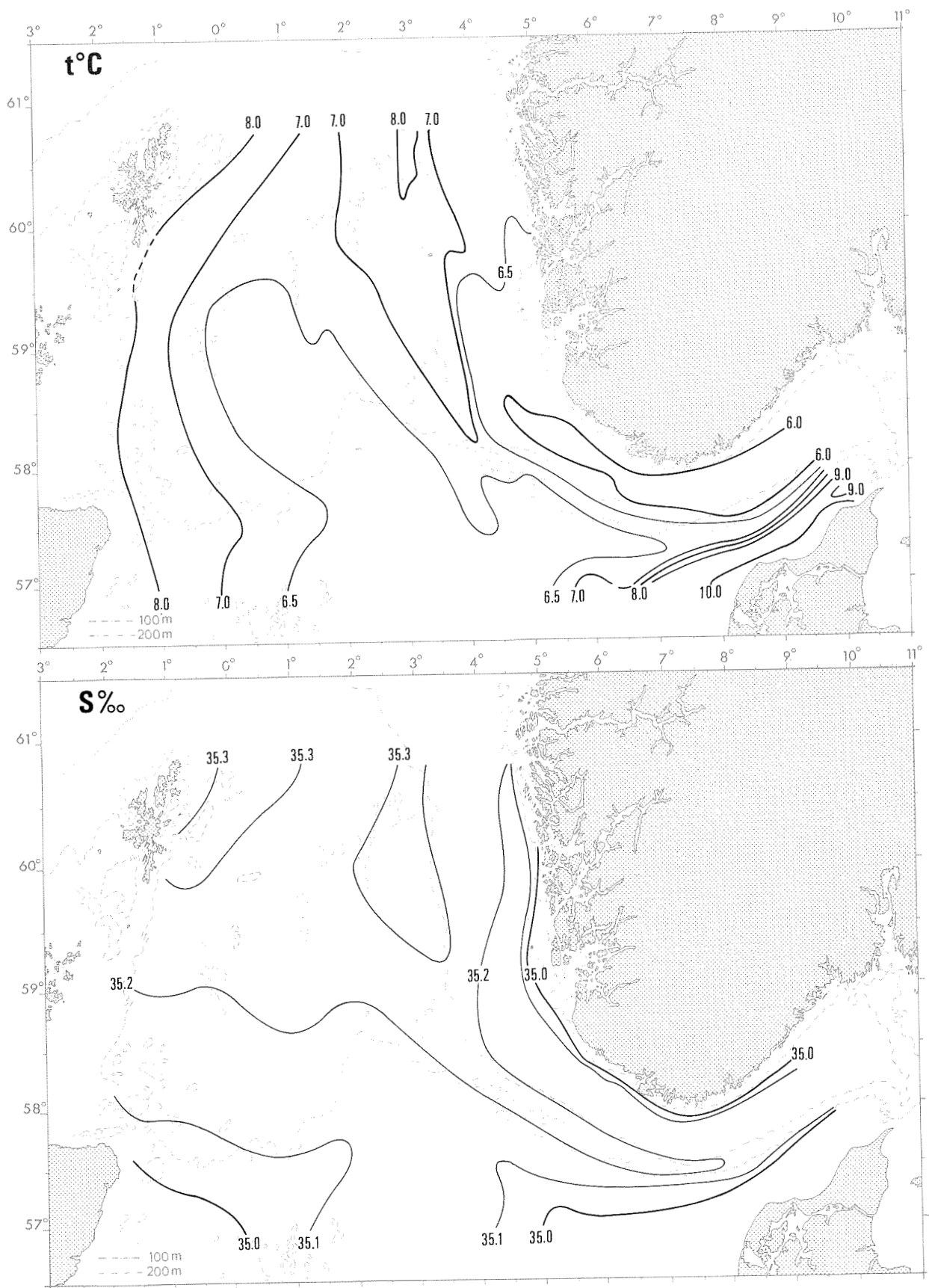

Bunn Bottom layer

Bunn Bottom layer

