

FISKEN OG HAVET, 9 - 1993
ISSN 0071-5648

EFFECTS OF SEISMIC SHOOTING ON CATCH AND CATCH-AVAILABILITY OF COD AND HADDOCK

by

Arill Engås, Svein Løkkeborg, Egil Ona and Aud Vold Soldal

HAVFORSKNINGSINSTITUTTET
INSTITUTE OF MARINE RESEARCH

AUGUST 1993

TABLE OF CONTENTS

	Page
EXECUTIVE SUMMARY	
1. INTRODUCTION	5
2. FISH HEARING IN RELATION TO SOUND FROM AIR GUNS	7
3. MATERIALS AND METHODS	14
3.1 Trial area	14
3.2 Acoustic mapping	15
3.3 Catch trials	21
3.4 Data analyses	26
3.5 Seismic shooting	28
3.6 Auxiliary measurements	29
4. RESULTS	31
4.1 Acoustic abundance estimates	31
4.2 Trawl catches	45
4.3 Longline catches	60
4.4 Stomach samples	70
4.5 Radiated noise measurements	72
4.6 Current measurements and STD-measurements	76
5. DISCUSSION	77
5.1 Does seismic shooting affect catch and catch-availability of cod and haddock?	77
5.2 Distance effect	83
5.3 Time effect	85
6. CONCLUSION	87
7. ACKNOWLEDGEMENTS	89
8. REFERENCES	90
APPENDIX A - G	93

EXECUTIVE SUMMARY

In May 1992 an experiment was carried out on North Cape Bank in the Barents Sea in order to answer the following questions:

- 1) Does seismic shooting with air guns affect catch and catch-availability of cod and haddock?
- 2) How far away from the seismic shooting area can possible effects be demonstrated?
- 3) How long after the conclusion of seismic shooting can possible effects be demonstrated?

This was done by means of fishing trials with trawl and longline and acoustic mapping of the fish distribution before, during and after the seismic shooting.

The fishing trials were conducted with a trawler and with an autoline vessel within an area of 40 x 40 nautical miles before (7 days), during (5 days) and after (5 days) seismic shooting. Both vessels used commercial fishing gear. In total, 62, 67 and 60 trawl hauls were made respectively before, during and after the seismic shooting. The trawl hauls were distributed over four distances from the seismic shooting area: 1) within the shooting area, 2) 1-3 nautical miles from the shooting area, 3) 7-9 nautical miles from the shooting area, and 4) 16-18 nautical miles from the shooting area. Longline fleets were placed at four corresponding positions in relation to the shooting area. In total 56, 40 and 35 longline fleets were hauled respectively before, during and after the seismic shooting.

Within the same area and time period, the fish distribution was mapped and abundance estimated by another trawler. The acoustic mapping was executed by crisscrossing the shooting area along transects out to 20 nautical miles. In addition, detailed mapping within the shooting area was carried out before and during the seismic shooting. Samples of the acoustically registered fish were taken with a standard sampling trawl.

The seismic air-gun shooting (5 days) was performed within an area of 3 x 10 nautical miles in the center of the area where the fishing trials were performed. The rigging of the air-gun array and the practical execution of the shooting was performed in accordance with the same guidelines that are followed in an ordinary three-dimensional survey for the oil industry.

The acoustic mapping and catching trials with trawl and longline on North Cape Bank show that the seismic shooting with air guns affects the fish distribution and catch rates for cod and haddock, not only locally within the area where the shooting is carried out, but also in significant surrounding areas.

The catches by trawl and longline consisted principally of cod and haddock, with cod as the dominant species. The trawl catch rates both for cod and haddock declined over the entire investigation area, even to the border, 18 nautical miles from the shooting area. On average for the whole area, the catch rate was halved when the shooting began. The reduction was greatest in the center, that is, in the seismic shooting area. Here the average catch for both species was reduced by about 70% during the shooting. The reduction in the trawl catches generally agreed with the acoustic observations, which showed a reduction of about 45% in the total quantity of cod and haddock within the investigation area. The reduction in acoustic quantity was also greatest in the central area.

The reduction in catch rates of cod by longline were lower than by trawl. The decrease was 44% in the seismic shooting area, with a gradually declining influence on the catches toward the border of the investigation area. For the longline fleets set furthest away from the shooting area (16-18 nautical miles), no decline in catch rates for cod was observed. For haddock the weight reduction per longline haul was about 50% over the entire investigation area.

In both the trawl and longline catches and in the acoustic abundance estimates a relatively greater reduction was found in large (>60 cm) than in small (<60 cm) fish. However, the number of small fish was reduced with a single exception: the quantity of small cod increased in the longline catches during the shooting.

Neither the acoustic mapping nor the trawl trials showed that the quantity of cod and haddock increased during the five days after the end of the seismic shooting. A change in the length distribution of fish by trawling toward the condition before shooting was observed. Longlining showed an increase in cod catches at the end of the trial period, but not in haddock catches.

1. INTRODUCTION

Since the early 1960's seismic shooting with air guns has been employed on the Norwegian continental shelf in order to map oil and gas resources in the ocean bottom. The extent of this activity has been greatly increasing. For example, about 40,000 linear kilometers were "shot" in 1974. In 1991 the number reached 329,000 (Anon. 1991). In 1992 the activity was expected to equal that in the preceding year. Not only has the effort on the traditional search areas in the North Sea increased, but the search area has been considerably expanded inasmuch as the areas north of N 62° are now becoming potential areas for oil exploitation. As the search areas expand, the searching intensity increases, and more and more of the most important fishing grounds are being subjected to seismic shooting, often conflicting with the fishery.

In fishing circles it has been claimed for many years that the catch rate declines when a seismic vessel arrives at a fishing ground and begins to shoot, presumably because the noise from the air guns scare the fish away. There is, however, little documentation on how seismic shooting affects fish behavior and catch-availability. Acoustic mapping and catching trials in the North Sea indicated that the fish distribution changes under the influence of seismic shooting (Dalen & Raknes 1985). There was, however, an insufficient quantity of fish in the investigated area in order to be able to draw completely safe conclusions on the scaring effect on fish. Trials off the coast of California showed that the longline catch rate for various redfish species was reduced by one-half under the influence of a single air gun (Skalski et al. 1992). Investigations of the collected catch data from longliners and trawlers before, during and after seismic shooting in Norwegian waters showed that the catches of cod by longline and as a secondary catch in shrimp trawls was reduced under seismic shooting (Løkkeborg & Soldal 1993). The collected catch data suffered, however, from rather large deficiencies. It was among other things difficult to evaluate how far away from a seismic vessel a possible scaring effect acts, and how much time it would take for the catches to normalize after the shooting was completed. It was therefore concluded that a controlled,

full-scale field experiment was necessary in order to be able to document the effects of seismic shooting in convincing manner.

In 1990 the Fish Capture Division at the Institute of Marine Research (which at that time was part of Fisheries Research Inc.) applied to the Norwegian Fisheries Research Council (NFFR) for funding to conduct a field experiment in order to map the effect of noise from air guns on the catch availability of fish. The appropriated sum for 1991 (made available to NFFR by the National Society for the Oil Industry, Oil and Energy Department, and Oil Directorate) was however insufficient to conduct a professionally defensible full-scale field trial. The effort in 1991, therefore, was alternatively placed in collecting catch data from fishing vessels that had fished in areas where seismic shooting was underway at the same time. The aim was to document possible effects on catch rates in ordinary fisheries. Such knowledge would also be valuable for planning a future full-scale trial.

New funds were appropriated for 1992 by NFFR (made available from the same organizations as mentioned above), which covered salary and operating expenses for the planned field experiments, as well as hiring a seismic vessel and a vessel for acoustic mapping of fish. In addition, the Fisheries Director granted the project a research fishing quota for cod and secondary catch which made it possible to hire two commercial fishing vessels for the catching trials. The Institute of Marine Research also made a significant contribution of its own resources. In May 1992 the field trials were carried out on North Cape Bank off the Finnmark coast.

The field trials were designed to answer the following questions:

- 1) Does seismic shooting affect catch and catch availability of cod and haddock?
- 2) How far from the seismic shooting area can possible effects be demonstrated?
- 3) How long after seismic shooting can possible effects be demonstrated?

2. FISH HEARING IN RELATION TO SOUND FROM AIR GUNS

Fish hear and react to sound and also make use of sound to communicate (Tavolga et al. 1981). It has been experimentally demonstrated that fish are sensitive both to pressure and to particle motion in a sound signal, and that it thereby can sense both sound strength and direction (Hawkins 1981). Here an evaluation is performed to determine how well fish can sense sound from seismic sources and how it might react to such sound, based on the available literature. This chapter does not include results from the new investigation and can therefore be read as an independent section.

What is critical for a fish to sense a sound signal is primarily signal strength and frequency, but also signal duration and natural background noise. Because sound intensity decreases with distance because of geometrical spreading and absorption, the distance between sound source and fish will have great importance for the sensing of sound. Physical conditions in the sea, such as thermocline formation and bottom topography can influence transmission loss, and thereby also how far away the sound can be heard.

Pressure variation in a sound pulse will be registered most easily by the swimbladder, which acts as an amplifier, or resonance cavity, for the inner ear. Sound direction can be determined by means of the relative movement of the otoliths (Popper & Platt 1983; Saidel & Popper 1983), because the inertia in these is greater than that of fish flesh otherwise when sound propagates through the fish. Fish can also determine direction to a sound source by means of phase differences at the coordinate otolith pair.

Sensitivity to single frequencies and bandwidth, or the width of the frequency spectrum, varies with fish species, but the optimal region for most species is between infrasound, less than 20 Hz (Sand & Karlsen 1986), and 700 Hz (Platt & Popper 1981; Buerkle 1968; Chapman & Hawkins 1973; Offut 1974). A few species possess good hearing up to 2000 Hz (Hawkins 1981). Fish without a swimbladder, such as mackerel, flatfish and a number of

bottom-dwelling species, have poorer hearing than species with a well-developed swimbladder (Hawkins 1981).

Cod and herring have a well-developed swimbladder and good hearing (Hawkins 1981). It has earlier been established that the sensitivity of cod is best in the frequency band 60-310 Hz (Chapman & Hawkins 1973), with maximal sensitivity at 160 Hz, where the hearing threshold is about 80 dB re 1 μ Pa. Sand & Karlsen (1986) showed later, however, that cod is also sensitive to infrasound.

In case a sound signal is within the audible range, an increase in sound level will increase the chance that the fish will sense the signal, but this is also influenced by the signal duration. The shorter the duration, the louder the signal must be in order that the fish be able to hear it (Hawkins 1981). For much shorter durations, Hawkins (1981) found that the detection threshold is 25 dB higher than for continuous sound. It is however doubtful that the pulse duration of an air-gun signal (20-40 ms) is short enough to influence the detection threshold. Fish such as cod and haddock communicate with themselves by means of comparable pulse durations (20-200 ms) (Hawkins & Rasmussen 1978).

Fish also react more strongly to pulsed sound than to a continuous sound signal (Blaxter et al. 1981), and a sound signal with rapid rise time acts more alarming than a long rise time to the same signal level (Schwarz 1985). Recently it was shown that low-frequency sound stimuli (5-10 Hz) are especially alarming to salmon, and that it is difficult for the fish to adapt to such low-frequency sound (Knudsen et al. 1992).

That which ultimately determines how far away a fish can hear a given signal is the background noise in the sea. In calm weather the noise level in the audible range of the spectrum is between 60 dB re 1 μ Pa/Hz and 90 dB re 1 μ Pa/Hz. For a fish to detect other sound than background, or ambient, noise, the signal must exceed the ambient noise by about 20 dB, or be about 100 dB re 1 μ Pa/Hz when the threshold is expressed in terms of spectral level.

In the light of this background on fish hearing capacity, it is possible to evaluate roughly how fish can sense the sound signal from seismic air guns, at what distance it can sense the sound over ambient noise, and how it will react.

Malme et al. (1986) found that single air guns produce a frequency spectrum from 5 to 200 Hz (-20 dB) and 5-150 Hz for arrays (constructed fields of air guns in fixed positions with the same or time-controlled firing times). At a lower level the air guns generate sound up to 500 Hz. The sound pressure at single frequencies or over bands varies, while the maximum level for most air guns is in the range 10-80 Hz. This indicates that with respect to frequency there is significant overlap between the sound produced by air guns and the general sensitivity range for marine fish hearing.

In deep, open waters, such as where the investigation took place, the sound from air guns initially propagates freely, with approximately spherical spreading. The sound intensity decreases rapidly with distance from the sound source. For example, the sound intensity 100 m from an air gun is reduced to 1/10000 (-40 dB) in relation to the reference intensity, at 1 m from the air gun. Physically this is described through the sonar equation in its simplest form:

$$I_r = I_0(10^{-\alpha R}/R^2)b(\theta) \quad ,$$

where I_r is the received sound intensity at distance R ; I_0 is the transmitted intensity on the acoustic axis computed at the reference distance, 1 m; α is the absorption coefficient; and $b(\theta)$ is the directivity at the angle θ from the acoustic axis.

In logarithmic form,

$$EL = SL - (20 \log R + \alpha R) + 10 \log[b(\theta)],$$

where EL is the sound echo level at distance r , SL is the source level, $(20 \log R + \alpha R)$ is the transmission loss TL over distance R , and $10 \log b(\theta)$ is the directivity (in decibels). The sound level can therefore be estimated as a function of distance when SL, absorption and direction is known.

The sound field from isolated air guns is approximately circular, or omnidirectional, which suggests that the sound propagates roughly equally in all directions, and computations show that even large arrays have low directivity, typically 60-70 degrees opening angle at the -10 dB level (Malme et al. 1986). This is determined by the total array dimensions, in both directions, in relation to the wavelength, the number and placement of air guns, and the firing times of the individual air guns in the array. It is reasonable for the present computations to assume that the intensity of horizontally transmitted sound is about 10 dB lower than on the acoustic axis, that is, when θ is greater than 45° , $b(\theta)$ is equated to 0.1. The next simplification is to neglect absorption at these low frequencies (α at 1000 Hz is 0.06 dB/km, and less under 1000 Hz).

The model for computation of the sound level as a function of distance when the source level is known is greatly simplified:

$$EL = SL - 20 \log R - 10 ,$$

In case a more precise estimate of sound level is desired, the model must be expanded to include effects of bottom depth, bottom substrate and thermocline formation both vertically and horizontally. This has been done in part by Malme et al. (1986), but it is also clear that such a model cannot replace direct measurements.

The source level SL for single air guns and air gun arrays has also been investigated and tabulated by Malme et al. (1986). They specify 212 dB re 1 μ Pa at 1 m as a typical value for single air guns and 250 dB re 1 μ Pa at 1 m for arrays. Greene (1985) reports a source level of 255 dB re 1 μ Pa at 1 m for a 20-air-gun array used in his investigations. In every case here

reference is made to the effective source level, computed directly from the peak pressure due to the source, measured on the acoustic axis:

$$SL = 20 \log(P_S/2P_R) \quad ,$$

where P_S is the peak-to-peak pressure referred to 1 m distance and P_R is the reference pressure, 1 μPa . If P_S is expressed in bars, this must be converted to micropascals (1 bar = 10^{11} μPa).

For the present study the air-gun array has a typical source level of about 250 ± 3 dB re 1 μPa at 1 m. In terms of spectral level this corresponds to 210 dB re 1 $\mu\text{Pa}/\text{Hz}$ at 1 m.

The fish ear integrates sound pressure over its entire frequency range of sensitivity, such that the total sound pressure sensed by the fish is roughly the same as the peak pressure in the air-gun signal.

Since most of the material that covers ambient noise and vessel noise is given in terms of spectral level, comparisons and distance computations are made directly in terms of the maximum values from the various spectra.

In case the ambient noise within the audible range of fish is 80 dB re 1 $\mu\text{Pa}/\text{Hz}$ and the effective detection threshold for signals from air guns is about 100 dB re 1 $\mu\text{Pa}/\text{Hz}$, the fish will be able to hear an air-gun array over significant distances (Table 2.1, Fig. 2.1). An air-gun array with a source level of 210 dB re 1 $\mu\text{Pa}/\text{Hz}$ at 1 m will, for example, be heard by fish more than 100 km away. Here the directivity loss is included.

Even if fish can hear sound, in the present context it is more important to estimate the limit at which fish will change their behavior because of sound from air guns. This may lie significantly over the detection limit. It is known from investigations of fish behavior in relation to vessel noise (Olsen et al. 1983; Ona 1988; Ona & Godø 1990; Engås et al. 1991)

that fish react with avoidance when the source level from machinery and propeller exceeds a certain level. Typical radiated noise levels from vessels in the audible range of fish is 150-160 dB re 1 μ Pa/Hz at 1 m, and local avoidance of large cod is observed up to 100 m from vessels (Ona 1988), or at about 110-120 dB re 1 μ Pa/Hz. For such noise it appears that fish react when the level is increased by about 20 dB over the level defined as the detection threshold. It is also known that the reaction threshold can depend on the time of year and fish condition. The reaction threshold for vessel noise agrees well with results from experimental exposure trials with air guns on redfish, where a behavior change was observed with a peak pressure of 150-167 dB re 1 μ Pa (Skalski et al. 1992), corresponding to 110-127 dB re 1 μ Pa in spectral level.

In case we use 120 dB re 1 μ Pa/Hz as the expected reaction threshold, the reaction distance can be roughly estimated as a function of source level (Table 2.1, Fig. 2.1).

Table 2.1. Example of expected detection and reaction distance of fish as a function of the air-gun-array source level. Assumed transmission loss: $20 \log R$.

Source level (dB re 1 μ Pa/Hz at 1 m)	Directivity (dB)	Detection distance (100 dB re 1 μ Pa/Hz) (km)	Reaction distance (120dB re 1 μ Pa/Hz) (km)
220	-10	316	31.6
210	-10	100	10
200	-10	31.6	3.2

It is stressed that the estimates are based on the available literature on fish hearing together with a simple propagation model, and that the numbers should not be confused with the expected effect on catch. What emerges clearly from the table and figure is that (1) fish can hear air-gun sound at considerable distances, 30-300 km, and (2) fish are expected to react, with behavior change, over large distances, roughly 3-30 km, both limits dependent on the source level of the air gun and the fish reaction threshold. The size of the investigation area, 40 x 40 nautical miles, is chosen based on these expectations, as well as experiences from earlier investigations (Dalen & Raknes 1985; Løkkeborg 1991; Løkkeborg & Soldal 1993).

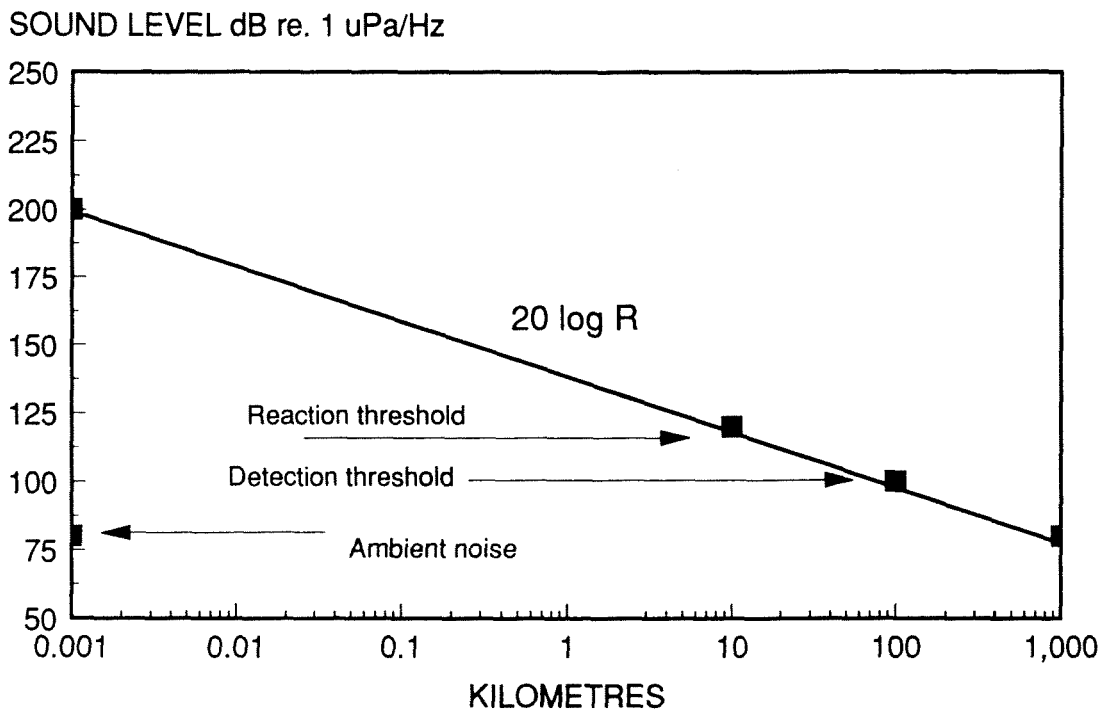

Figure 2.1. Sound level as a function of horizontal distance from an air gun array, with the approximate fish detection and reaction thresholds for such sound as indicated. The source level, ambient noise, and detection and reaction thresholds are given in terms of spectral level.

3. MATERIALS AND METHODS

3.1 Trial area

In order that the trials be as realistic as possible, the seismic shooting was conducted as it usually is in a three-dimensional investigation, or survey. On the basis of information from Geco-Prakla, Stavanger, concerning ordinary survey operation, it was estimated that an area of 3 x 10 nautical miles (5.5 x 18.5 km) could be covered by the seismic vessel in a five-day period.

Based on considerations of the expected source level from the air gun array, absorption of sound in water and knowledge of fish hearing and reaction thresholds (Chapter 2), it was determined to perform trawling 18-20 nautical miles (33-37 km) to each side of the seismic shooting area. The trial area was thus roughly 40 x 40 nautical miles (74 x 74 km), with the shooting area in the center (Fig. 3.1.1). The center of the trial area was set at N 72°20', E 26°00'.

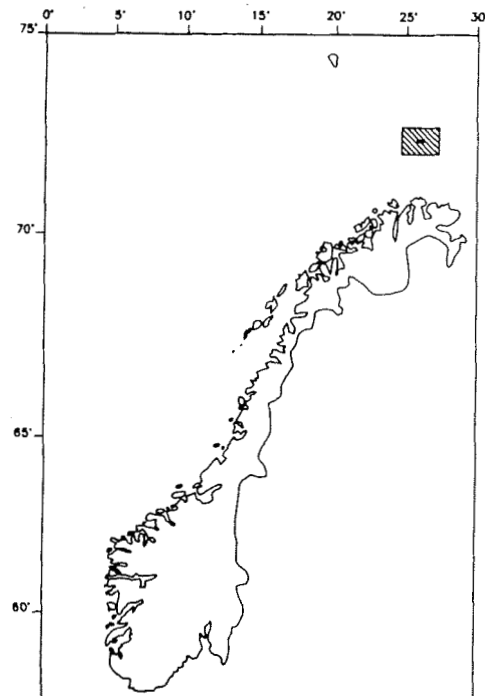

Figure 3.1.1. Trial area (shaded) on North Cape Bank, showing also the centrally located shooting area.

Nysleppen, in the Barents Sea, was originally chosen as the particular area for executing the trials. Preliminary trial fishing showed, however, that there was insufficient fish in the area to perform the planned program. Thus, North Cape Bank was chosen, because the area satisfied the prerequisites for catch conditions, fish distribution and homogeneity, established in advance for the trial area. Fishing vessels that had fished in the area just prior to the start of the trial could report consistently good catches of cod and haddock with a wide spread in the size distribution of caught fish. The area also has good operating conditions for both trawl and longline, and the bottom depth is relatively even (250-280 m). The trials were conducted in the period 30 April-18 May 1992. The weather conditions during the trial period were good.

3.2 Acoustic mapping

Vessel

The fresh-fish trawler "STALLO" (F-84-H, 299 Brt, 1200 BHK) was hired for a total period of 20 days, from 30 April to 19 May 1992, to perform mapping of the fish distribution in a specified area within and about the seismic shooting area. It was equipped with a SIMRAD ES400 echo sounder and SCANMAR trawl instrumentation, together with a RAYSTAR 2000 GPS satellite navigator.

Acoustic instruments and calibration

The research echo sounding system SIMRAD EK500 was mounted on the bridge and connected to the vessels own split-beam transducer (ES38-29), GPS navigator, echogram printer, portable PC (Toshiba 3100) over a serial line, and SUN Sparc 2 workstation over Ethernet for logging of raw data on the workstation (Bergen Echo Integrator (BEI)). For the echo sounder frequency of 38 kHz, this corresponds to the instrumentation that is currently

in use on the research vessels of the Institute of Marine Research (Knudsen 1990). The instruments were tested for functionality on 30 April 1992 and calibrated under good conditions in Olderfjord, Finnmark, 1 May 1992, by means of a calibration target with known target strength (60-mm-diameter copper sphere, $TS = -33.6$ dB), in accordance with the calibration routine described by Nes (1991) and Foote et al. (1987). Calibration data and settings of echo sounder and echo integrator are given in Appendix A, Table 1. Radiated noise measurements for "STALLO" as a function of vessel speed showed a low noise level on the echogram when the speed was less than about 10 knots. A typical example of registration of cod and haddock from "STALLO" is shown in Figure 3.2.1.

Sampling

"STALLO" was rigged for bottom trawling with a Campelen 1800 sampling trawl (Appendix B, Fig. 1), with rockhopper trawl gear, 40 m sweep and V-doors. The trawl is used as a standard sampling trawl at the Institute of Marine Research (Engås & Godø 1989). Trawling by "STALLO", which should mainly support the acoustic measurements, was performed at random positions along the vessel path within each subarea. All together 94 trawl hauls were taken (Fig. 3.3.1). The door spread for the sampling trawl was about 54 m, with an average trawl height of about 3.8 m.

Survey plan and transects

To achieve the aim of the acoustic part of the investigation most effectively, it was decided to cross the shooting area systematically out to a radius of 20 nautical miles from the center, where the central crossing point was varied from transect to transect. In addition, the inner area was mapped more densely by means of shorter north-south transects before and after the shooting. The actual survey grid for the several periods is shown in Figure 3.2.2. Except for two short breaks because of bad weather and a stop from 6 May 0240 hours (GMT) until 7 May 0840 hours (GMT), for a meeting with the seismic vessel in Hammerfest, the acoustic data were continuously collected.

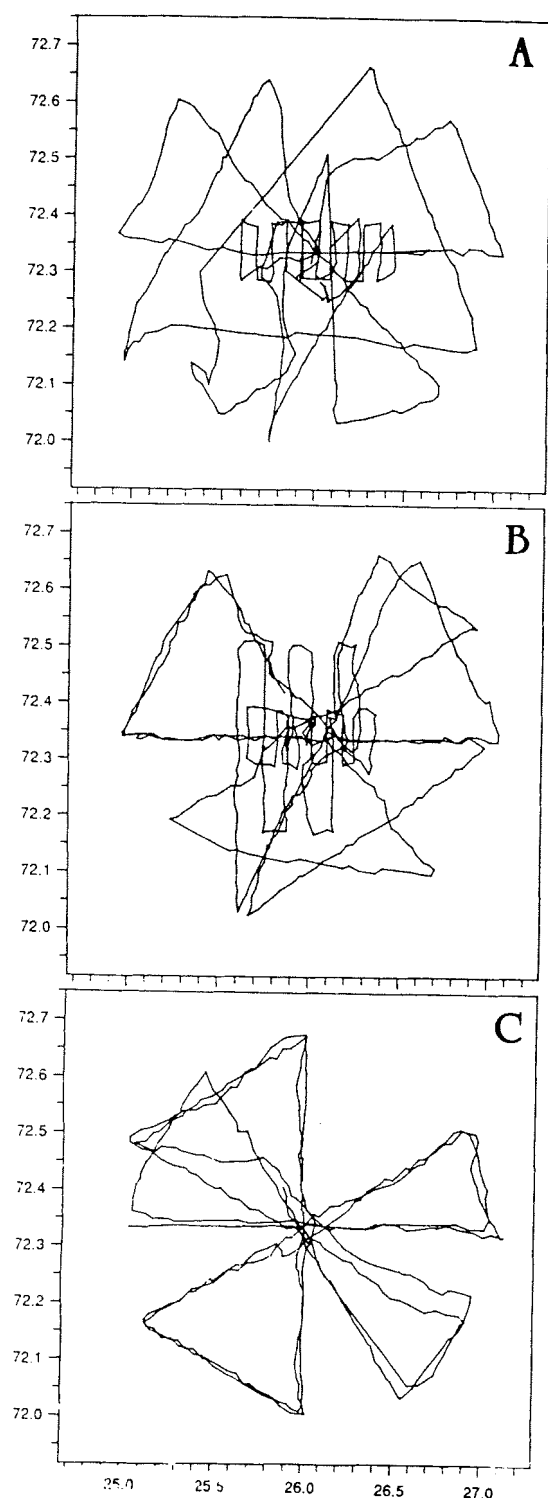

Figure 3.2.2. Survey grid for the acoustic investigations with M/Tr "STALLO" before (A), during (B) and after (C) shooting. The coordinates are given in decimal degrees.

Treatment of the acoustic data and abundance computations

Based on the trawl catches and echograms, the acoustic registration was "interpreted", or divided among the following categories: cod/haddock, capelin, herring, plankton and 0-group fish, and the results stored with 1-nautical-mile horizontal resolution and 50-m vertical resolution. In the bottom channel (the lowest 10 m) the resolution in the database is 2 m. The interpretation was performed daily during the cruise. The species category cod/haddock was later divided by using the catches in the sampling trawl in accordance with the size distribution, that is, the relative acoustic contributions (Appendix A).

During further treatment of the data, the integrator channels for cod and haddock were combined to form a pelagic part and a bottom part, which were then presented on distribution maps. The quantity of other species was quite small in relation to the total, and is therefore not further analyzed.

The investigation area has been divided up into five parts (Fig. 3.2.3): an inner (shooting) area of size 3 x 10 nautical miles, and further in circular belts, or annuli, each with 5-nautical-mile width (B, C, D, E). The average acoustic

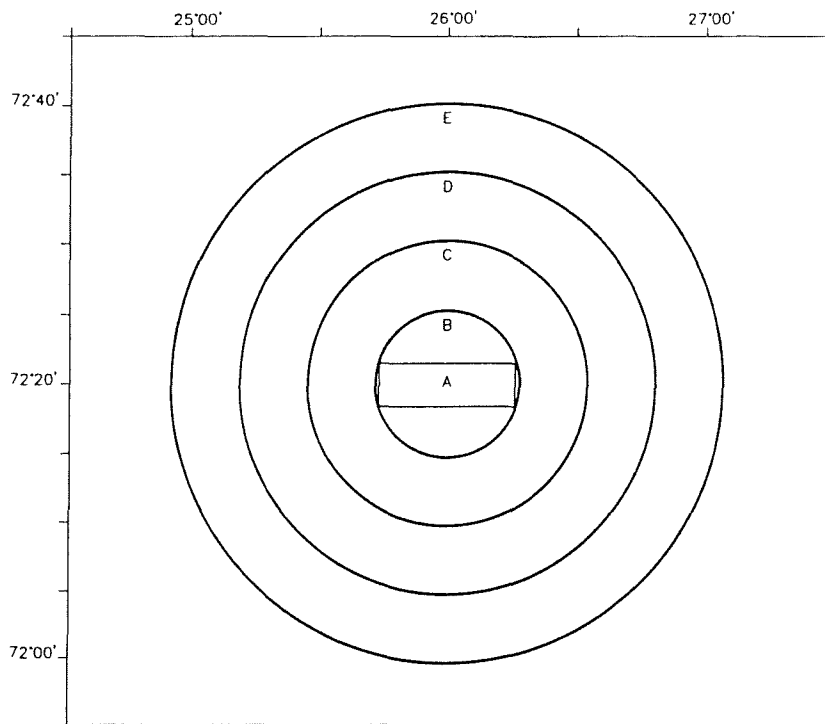

Figure 3.2.3. Subdivision of the survey region for computations of acoustic abundance.

density for the pelagic part, bottom part and total is computed for all areas and for each time period: before, during and after the seismic shooting. The average acoustic density for the whole area (F) inside a circle of radius 20 nautical miles as measured from the shooting area is also computed.

The acoustic measures of area density for cod and haddock are converted to biological quantity, namely number and weight, in 5-cm groups by computing the average target strength TS from the trawl catches in accordance with the target strength relationship used for these species in the Barents Sea (Appendix A). Since the acoustic density measures describe the relative distribution of fish quantity over time and space, the conversion to number and weight is made only for the total area, and by combining the trawl catches for each time period.

The average weight for each length group is computed from individual length-weight data for cod and haddock from the entire 1992 season in the southwestern part of the Barents Sea (Appendix C, Figs. 3 and 4). Different length-weight relations were used to convert the

length data from the trawl catches by "STALLO" and longline catches by "LORAN". For the longline data the relation was derived from measurements made by "ANNY KRÆMER" during the trial (Appendix C, Figs. 1 and 2). Because of mesh selection effects in trawling, the catch mainly contained fish over 30-40 cm. Consequently, these measurements could not give information on the relationship between length and weight for smaller fish. In the catches with the sampling trawl on "STALLO", fish under about 40 cm constituted the major part of the catches, and it was decided to use length-weight relationships from the Barents Sea stock-monitoring program of the Institute of Marine Research.

Statistical computations

Acoustic data are gathered continuously along transects, and nearby measurements are often autocorrelated. At present there is no recommended, exact method for computing the variance associated with the mean value of density within a given area of such a survey (Simmonds et al. 1991). In the tables of results two measures of variance are used, in both cases expressed as a percentage of the mean value:

Var. A: This is a straightforward computation of the classical variance for normally distributed data, where it is assumed that each measurement within a given area is independent and random. This will usually underestimate the true variance, because possible autocorrelations in the data have not been treated. The variance is computed thus:

$$\text{Var. A} = \frac{s}{\bar{z}\sqrt{n}} ,$$

where s is the standard deviation, z is the average value, and n is the number of observations. The variance is here expressed as a fraction of the average value.

Var. B: A new method, which has not yet begun to be used as a standard tool for variance estimation in stock measurement, derives from geostatistics. The method is described by Petitgas & Poulard (1989) and Petitgas (1990) and is compared with other methods for computing variance by Simmonds et al. (1991). The method has been shown to give realistic estimates of variance compared with data from repeated surveys in a closed fjord, and removes the effect of autocorrelation in the data. It is here expressed through the estimation variance (σ_E^2) and given as a fraction of the average value:

$$\text{Var. B} = \frac{\sigma_E}{\bar{z}}$$

3.3 Catch trials

The trawler "ANNY KRÆMER" (T-35-T, 477 Brt, 2400 BHk) and the autolongliner "LORAN" (M-19-G, 144 Brt, 865 BHk) were hired to execute the fishing trials according to plan, that is, according to the experimental design. The vessels used the same gear as under ordinary fishing operations.

Trawl trials

The trawl that was used was a standard fishing trawl, Alfredo no. 3 (Appendix B, Fig. 2). It was rigged with 145-m sweeps and V-doors (7.8 m², 2200 kg). The mesh size in the codend (twin bags) was measured with an ICES mesh-size meter (5 kg loading) to be 146-147 mm. Because of a machine failure "ANNY KRÆMER" had to interrupt its work, for repair in harbor, for two days in the period before the seismic vessel arrived. The trawl trials stopped, therefore, for the period from 3 May 1700 hours (GMT) to 5 May 2100 hours (GMT).

Each trawl haul lasted one-half hour and the towing speed was 3.5 knots (1.8 m/s). The trawl geometry was measured with a SCANMAR distance sensor on the doors and a height sensor placed in the middle of the headline. The door spread was measured as about 150 m, and the vertical opening of the trawl was about 4.2 m. The sweep area for each trawl haul, that is, the distance between the trawl doors multiplied by the towed distance, was 0.142 square nautical miles.

The trial was divided up into three time periods: **before** (7 days), **during** (5 days) and **after** (5 days) shooting. The total number of trawl hauls was, respectively, 62, 67 and 60 for the periods before, during and after the seismic shooting (Fig. 3.3.1). Of these, four hauls were taken outside of the investigation area (about 28 nautical miles (50.4 km) from the shooting area), two before and two during the shooting. The other trawl hauls were distributed at four distances from the seismic shooting area: 0) within the shooting area, 1) 1-3 nautical miles (1.8-3.5 km) from the shooting area, 7) 7-9 nautical miles (13-16.7 km), 16) 16-18 nautical miles (29.6-33.3 km). The degree of coverage (total sweep area in relation to the total shooting area (3 x 10 nautical miles)) of the trawl hauls that were taken within the shooting area was 5.7, 6.6 and 5.2%, respectively before, during and after the shooting.

An attempt was made to distribute the trawl hauls such that the error arising from possible geographical differences in fish density within the trial area would be as small as possible, and such that it would be possible to computationally relate the changes in catch and distance from the shooting area. Care was taken to ensure that the sequence of the trawl hauls would not influence the results. For example, catch rates often vary between day and night. Therefore the transects were designed such that the proportion of day trawls was approximately equal for every time-distance combination. In order to smooth the effect of geographical and time-based variations, a transect was followed from the central area towards the border of the area. The direction of the transect was randomly varied each day.

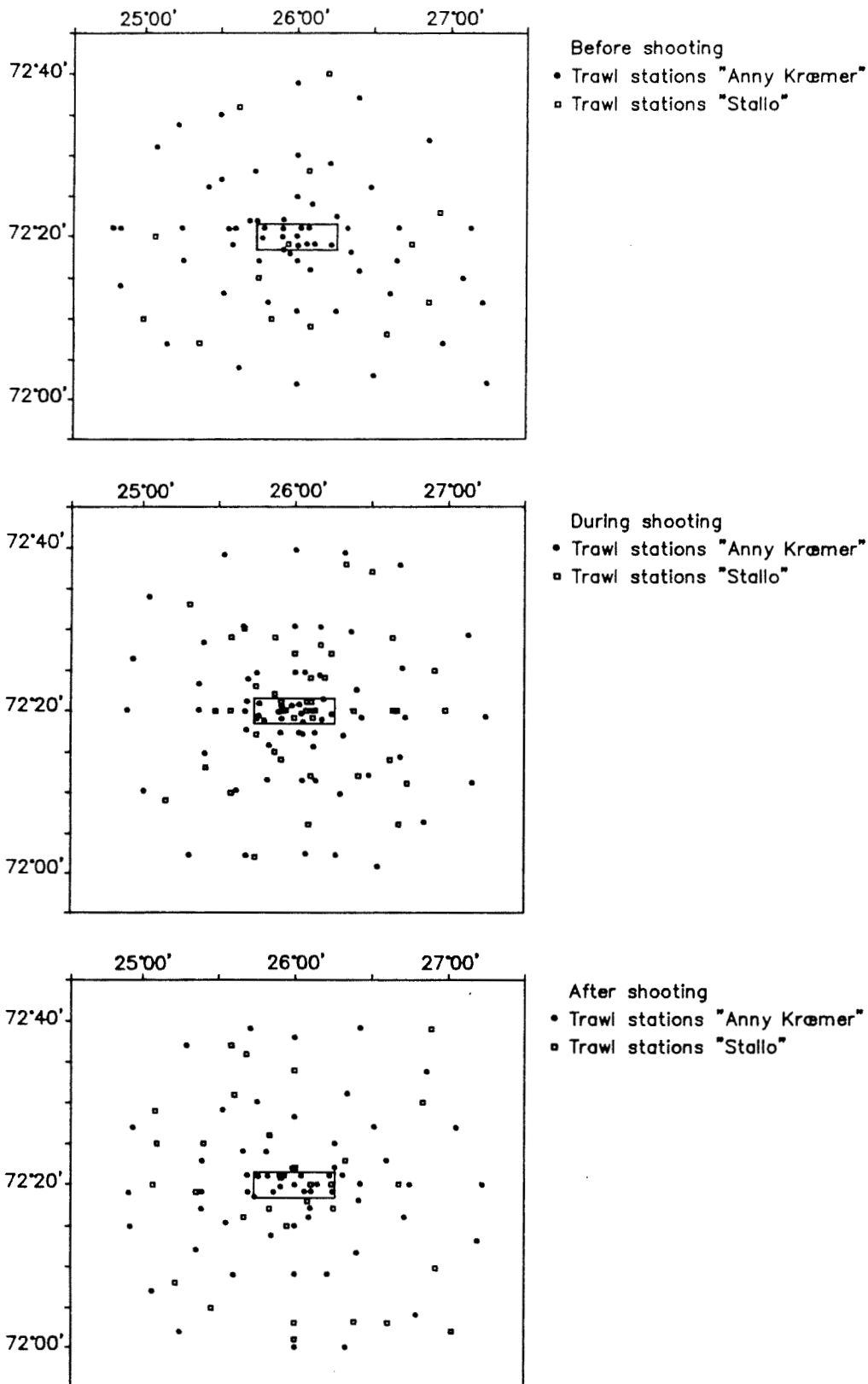

Figure 3.3.1. Distribution of trawl hauls taken in the survey area before, during and after shooting. The starting point for each trawl is indicated. "ANNY KRÆMER" fished with a standard cod trawl (Alfredo no. 3) and "STALLO" with an Institute of Marine Research sampling trawl (Campelen 1800).

Longline trials

The longliner used Mustad Quick Snap line (7 mm), rigged with double-twisted gangions supply no. 14 with EZ-hook (quality 39975, no. 12/0). Each longline fleet consisted of 3000 hooks, where the distance between each hook was 1.3 m (longline length 3900 m). The longline was baited with 50% mackerel and 50% squid. The bait width was about 30 mm.

Eight longline fleets were hauled each day. As with the trawl hauls, the longline fleets were set at four different distances in relation to the shooting area (Fig. 3.3.2), that is, two longline fleets were set at each distance every day. In the figure captions the four positions are called 1000 (within the shooting area), 2000 (1-3 nautical miles from the shooting area), 3000 (7-9 nautical miles), and 4000 (16-18 nautical miles). Since the two longline fleets that were set each day at the same distance from the shooting area were relatively close (0.5 nautical miles (0.9 km) east-west distance), these two were viewed as one under the analysis of variance. For longline there is therefore only a single observation at each distance per day. As with trawling, the innermost longline fleet was placed inside the shooting area. The others were placed along a transect radiating from the the central area. In contrast to trawling, these transects ran only straight north or straight south from the center. This was done throughout the trial to smooth out the effect of the current direction. In total 56, 40 and 35 longline fleets were hauled respectively before, during and after the seismic shooting. The longline fleets were placed between 0200 and 0800 hours (GMT) every day. The soak time of the longline fleets varied from 6 to 18 hours. To avoid influence of the soak time on the results, this time was varied in the same manner before, during and after the seismic shooting.

Biological samples

Fish caught by trawl and longline were classified by species and length-measured (rounded down to the nearest whole centimeter) with the exception of a few large trawl hauls (over about 1000 kg) where a partial sample was measured. On board "ANNY KRÆMER" the total weight of each species was registered, and the length and weight (round weight) of individual cod and haddock were measured. The length-weight relationship was computed

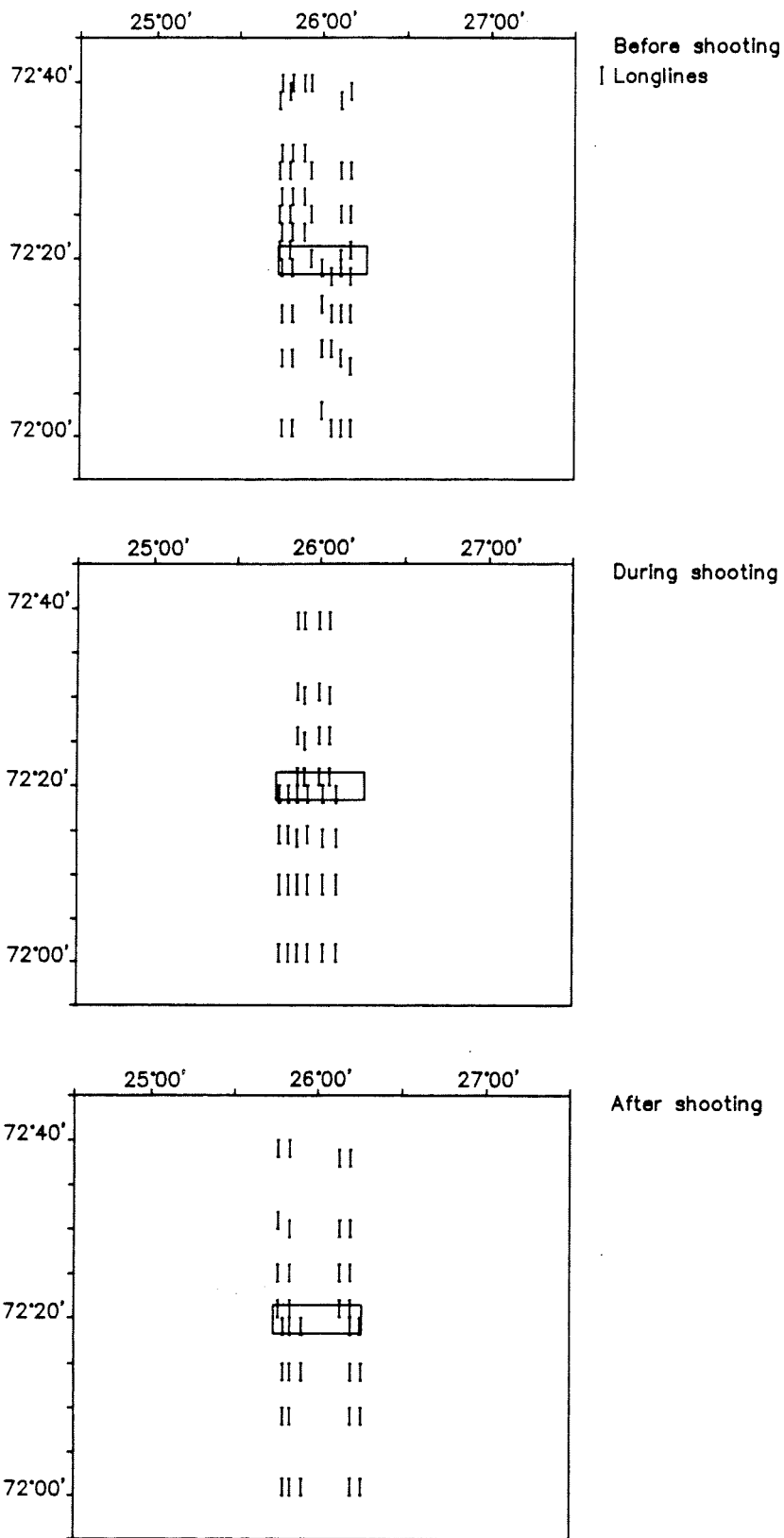

Figure 3.3.2. Placement of longline fleets in the trial area before, during and after shooting.

for both species in order to be able to compute the weight of the longline catches on the basis of length data, since the longliner did not have an electronic scale on board. The length-weight relationships for cod and haddock that were computed during the cruise are given in Appendix C, Figs. 1 and 2.

Stomach samples from cod were taken daily at randomly selected trawl and longline stations. The longliner also took stomach samples from haddock. The stomachs were frozen and analyzed at a later time.

3.4 Data analyses

Trawl

In order to investigate whether seismic shooting has an effect on the catch rates for fish by trawl, the following model was used for cod and haddock:

$$(1) \quad y_{ijk} = \mu + \alpha_i + \beta_j + (\alpha\beta)_{ij} + \varepsilon_{ijk}$$

where y is the catch in kilograms per trawl haul (logarithmically transformed), μ is the expected catch, α_i is the distance effect, β_j is the effect of time in relation to the seismic shooting, $(\alpha\beta)_{ij}$ is the interaction between time and distance, and ε_{ijk} represent the random variation. The reason that a logarithmic scale is used rather than a linear scale is that the variance is often proportional to the square of the mean for marine catch data (Pennington 1983; Pennington & Vølstad 1991) and that a logarithmic transformation will consequently stabilize the variance (see, for example, Snedecor & Cochran 1980). Furthermore it might be expected that a possible effect of seismic activity will be proportional to density, hence linear in relation to the logarithmic scale.

The experimental design was roughly balanced (Table 3.4.1) and the model (1) adapted to application of type III sum-of-squares with multi-factor analysis of variance (Statgraphics STSC, Inc. 1991). The approximate balance in the experimental design rendered the interpretation of factors in the analysis relatively uncomplicated.

Table 3.4.1. Number of combinations of time and distance in the trawl trial.

Time	Distance			
	0	1	7	16
Before	12	16	16	16
During	15	16	17	17
After	12	16	16	16

Table 3.4.2. Number of combinations of time and distance in the longline trial.

Time	Distance			
	1000	2000	3000	4000
Before	7	7	7	7
During	5	5	5	5
After	5	5	4	5

Longline

In order to analyze possible effects of seismic shooting on longline catches, the same statistical model was used as for the trawl catches. For the model (1), y is the average catch in kilograms (after logarithmic transformation) for the two longline fleets that were taken at the same distance on the same day. Again, μ is the expected catch, α_i is the distance effect, β_j is the effect of time in relation to seismic shooting, $(\alpha\beta)_{ij}$ is the interaction effect, and ϵ_{ijk} is the random variation. It is to be emphasized that the trial area for longline is a subset of that for the trawl trials (Figs. 3.3.1 and 3.3.2). The experimental design for longline is approximately balanced (Table 3.4.2).

3.5 Seismic shooting

The seismic shooting was conducted from 8 May 1992 0009 hours (GMT) to 12 May 1758 hours (GMT). The assignment was carried out by the business firm Geco-Prakla, Stavanger, with the seismic vessel R/V "ACADEMIC SHATSKIY". The rigging of the air-gun array is shown in Figure 3.5.1. The air guns were towed at 6 m depth. Rigging of the air-gun array and practical execution of the shooting assignment was performed according to the same guidelines that are used for ordinary three-dimensional surveys for the oil industry. Listening cables were not used, because this was not of interest to the trial. At the same time this simplified the turning operation at the end of one transect and start of the next.

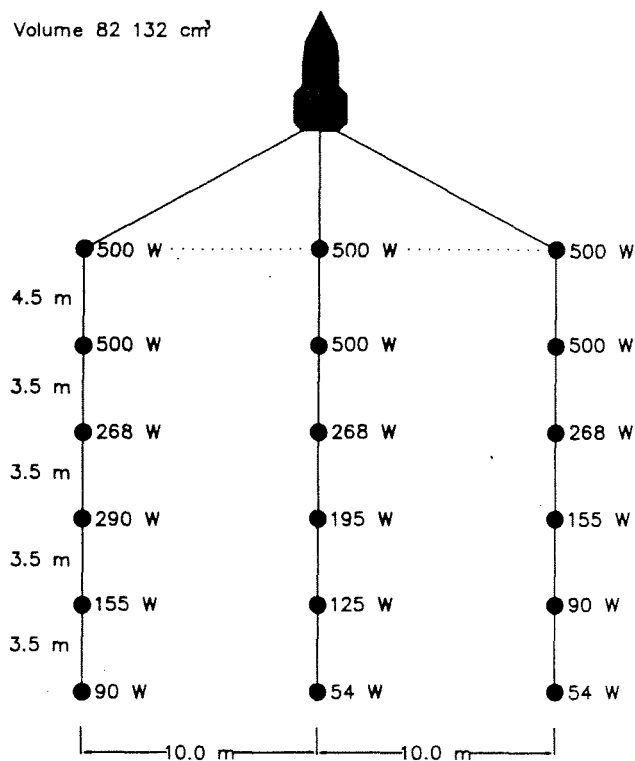

Figure 3.5.1. Rigging of the air gun array on "ACADEMIC SHATSKIY".

The seismic shooting area (3 x 10 nautical miles (5.5 x 18.5 km), Fig. 3.1.1) was positioned in the center of the trial area. It was planned to shoot a total of 45 transects, each 10 nautical miles long, with a distance of 125 m between adjacent transects. In fact, 36 of the planned

transects were shot, while nine were omitted because of expiration of the contract time (Appendix D). The shooting was executed at a speed of 4.8 knots, and a shot fired every 10 seconds, that is, every 25 m.

3.6 Auxiliary measurements

Radiated noise measurements

During firing of the air-gun array sound measurements were made in order to be able to relate possible scaring effects on fish to the sound level and frequency spectrum from the air-gun array. The measurements were made from "STALLO" while anchored in the shooting area with engine turned off. A hydrophone (Brüel and Kjær, type 8104) was suspended at 80 m depth and the signals from this logged on a digital tape recorder (Sony Dat Pro II) for later analysis. The distance from "STALLO" to "ACADEMIC SHATSKIY" was measured with radar and visually judged within the shortest radar distance, 50 m. The equipment was calibrated (Brüel and Kjær calibrator, type 4229) before and after the measurements.

In addition, the four vessels were measured in two different situations:

"ACADEMIC SHATSKIY": During cruising (about 12 knots) and at the same speed that is used with the air-gun array (4.8 knots).

"ANNY KRÆMER": During cruising (about 10 knots) and during trawling (about 3.5 knots).

"LORAN": During cruising (about 10 knots) and with the same speed as under hauling of longline (about 2 knots).

"STALLO": During cruising (about 10 knots) and during trawling (3 knots).

The first two vessels were measured on North Cape Bank, while the other two vessels were measured in the Sørøy Sound in the vicinity of Hammerfest. "ANNY KRÆMER" and

"ACADEMIC SHATSKIY" were measured according to the same process as mentioned above. During measurement of "STALLO" and "LORAN" a motorboat was used as a measurement platform. The measurement procedure was otherwise the same as for the other vessels. Before and after each measurement series the ambient noise level was registered.

The sound spectra from the vessels were analyzed in 1/3-octave bands with a Brüel and Kjær real-time analyzer, type 2143, while the recordings made during detonation of the air-gun array were analyzed with a Brüel and Kjær frequency analyzer, type 2143 FFT, and a Philips storage oscilloscope.

Current measurements

It is known that the catch rates with longline are greatly reduced in the presence of strong currents. In order to be able to account for such a factor, current measurements were made in the period 4 May - 17 May. A current meter (SD2000) was secured 10 m over the bottom in the center of the seismic shooting area.

STD-measurements

The propagation of sound from the seismic source can be affected by the vertical sound speed profile in the water masses, particularly in the refraction of horizontally directed energy from the air-gun array upwards toward the surface or downwards toward the bottom. In order to be able to assess this, M/Tr "STALLO" took 11 STD-stations within the survey area. A portable mini-STD (Gytte 1991), which measures salinity (conductivity), temperature and pressure, was lowered at the recommended speed (1 m/s) to about 10 m over the bottom.

4. RESULTS

4.1 Acoustic abundance estimates

The conditions for acoustic abundance estimation of cod and haddock on North Cape Bank were nearly ideal during the investigation period. Figure 4.1.1c shows the combined distribution of cod and haddock, expressed in acoustic units of area density, with constant-density contours indicated. The distribution of the total quantity is reasonably even throughout the entire area, with the highest density in the northwest and southeast parts of the area and lower densities in the north and northeast.

In Figures 4.1.1a and 4.1.1b the total quantity is separated into pelagic and near-bottom parts. These show that the pelagic part constituted the major part, and that the near-bottom part had a slightly different horizontal distribution than that presented by the total quantity. Where the density was lowest in the pelagic part, for example, in the east, the density was highest near the bottom. The major part of the fish were found in the lowest 50 m of the water column, with about 30% of the total quantity in the bottom channel. The distribution map for the total quantity gives the best picture of the actual distribution pattern of cod and haddock before shooting.

The density distribution lacked 0-values anywhere in the investigation area, and the acoustic average values had a small variance (Tables 4.1.1-4.1.3). As an example, the acoustic density estimate for cod and haddock over the entire investigation area, that is, in the circular area with radius of 20 nautical miles, has an average value $\langle s_A \rangle = 129.8 \text{ m}^2/\text{nm}^2$ and a variance of $\pm 5.4\%$. The low variance is a result of the evenness of the fish distribution, but also a result of the high degree of coverage, which revealed the structure in the density distribution.

The density and distribution of cod and haddock during the seismic shooting is shown in Fig. 4.1.2 and during the period after the shooting in Fig. 4.1.3. Clearly there is a significant density reduction throughout the entire area, especially in the central area, within about 5

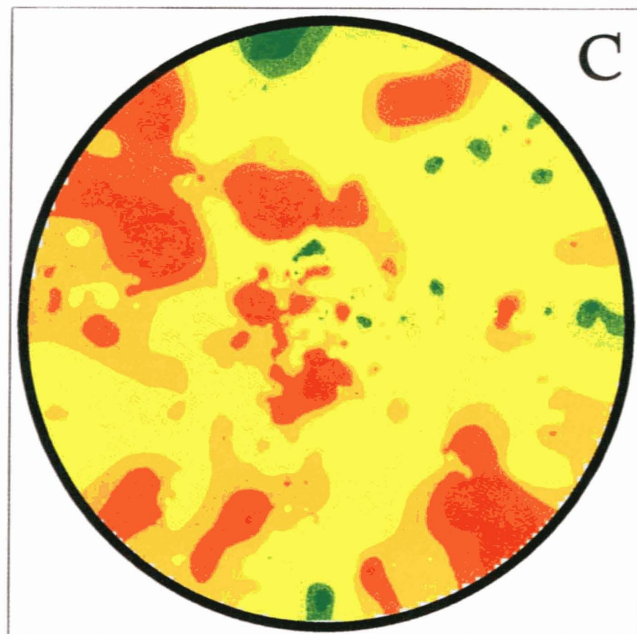
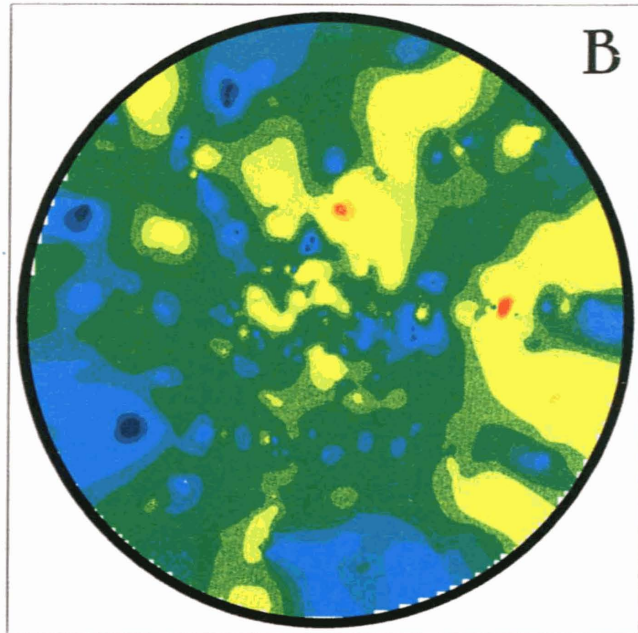
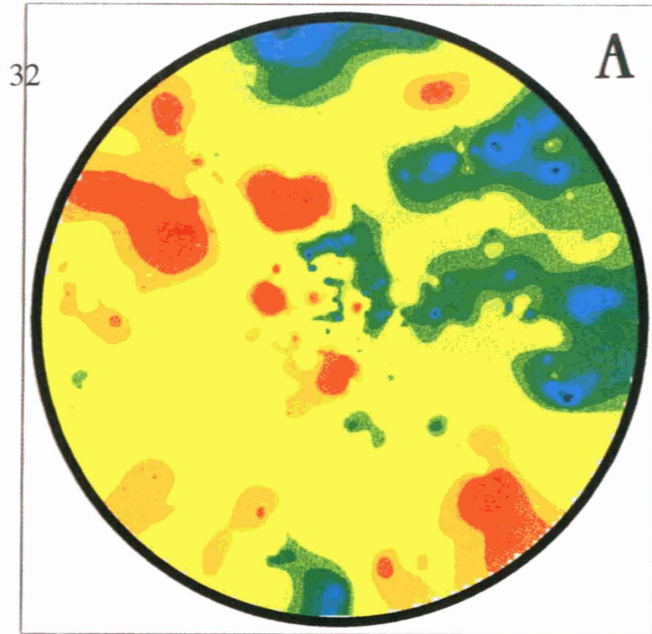

ACUSTIC DENSITY

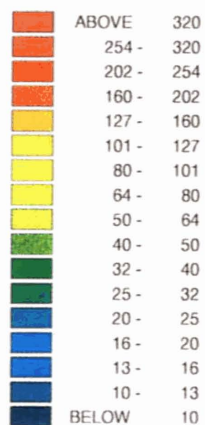

Figure 4.1.1. Distribution of cod and haddock in absolute units of acoustic density (m^2/nm^2) before the seismic shooting. Pelagic (A), bottom (B) and total (C). The bottom channel thickness is 10 m. The displayed region has a diameter of 40 nautical miles, with center at $N72^{\circ}20'$, $E26^{\circ}00'$.

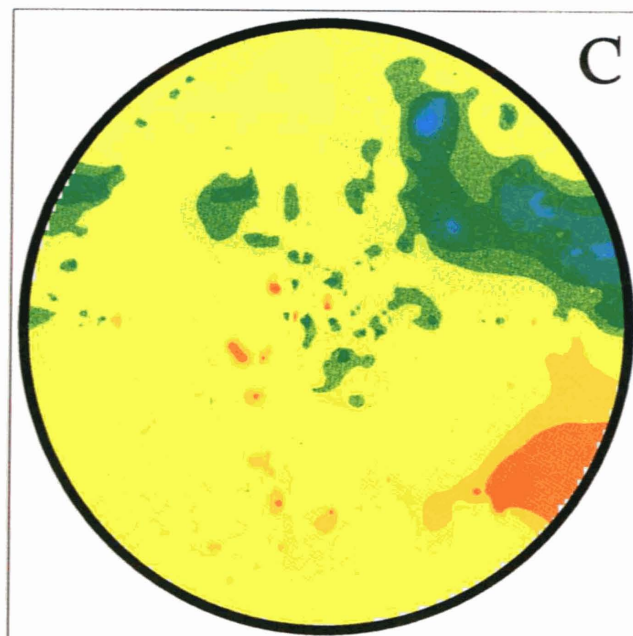
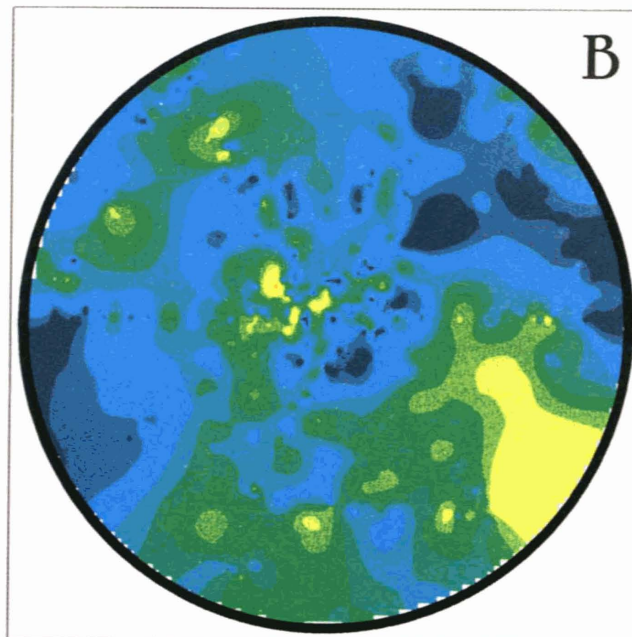
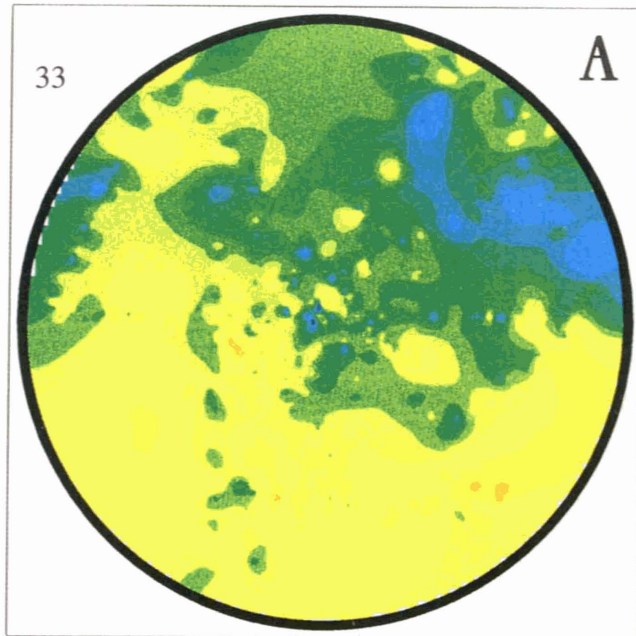
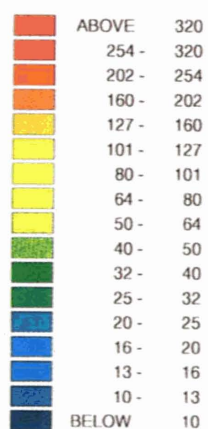
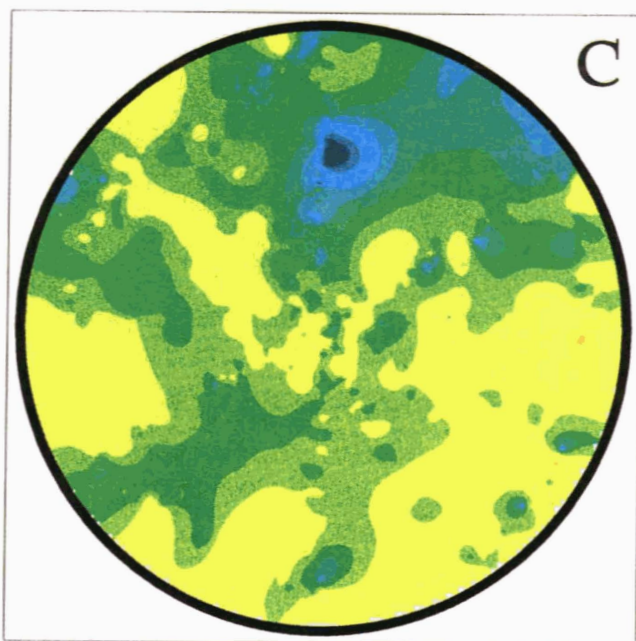
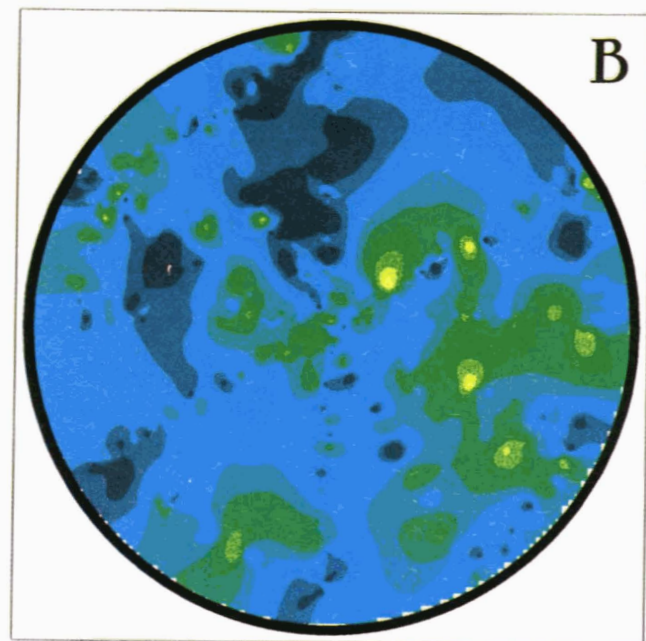
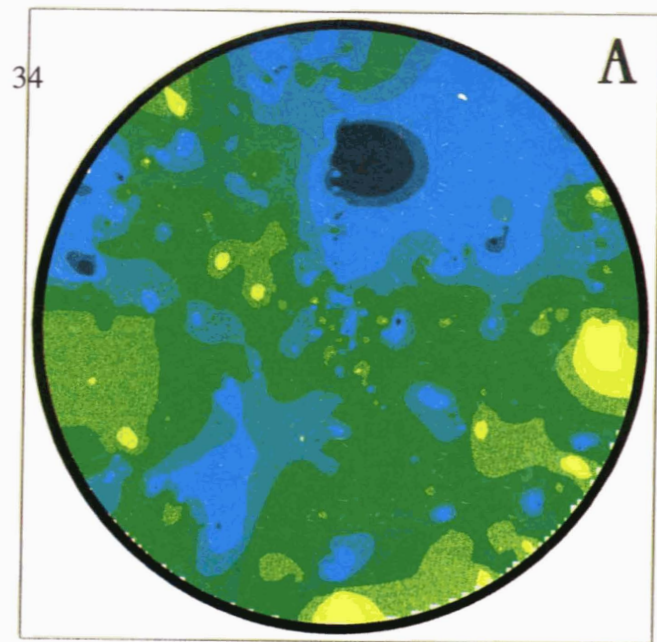

Figure 4.1.2. Distribution of cod and haddock in absolute units of acoustic density (m^2/nm^2) during the seismic shooting. Pelagic (A), bottom (B) and total (C). The bottom channel thickness is 10 m. The displayed region has a diameter of 40 nautical miles, with center at $N72^{\circ}20'$, $E26^{\circ}00'$.

ACUSTIC DENSITY





ACUSTIC DENSITY

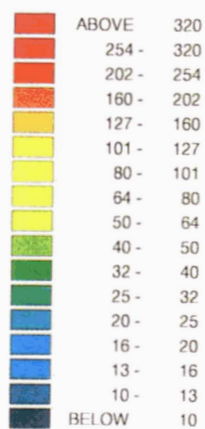

Figure 4.1.3. Distribution of cod and haddock in absolute units of acoustic density (m^2/nm^2) after the seismic shooting. Pelagic (A), bottom (B) and total (C). The bottom channel thickness is 10 m. The displayed region has a diameter of 40 nautical miles, with center at $N72^{\circ}20'$, $E26^{\circ}00'$.

Table 4.1.1. Acoustic measurements of average fish density of cod and haddock before the shooting started, computed for each region in Fig. 3.2.3 and for the total region (F), expressed in terms of the average area backscattering coefficient $\langle s_A \rangle$, with the variance computed using ordinary statistics and geostatistics, respectively, expressed as a percentage of the average. The number of mile-intervals used in each area (N), area, and degree of coverage (DG) are given. The degree of coverage is computed according to Aglen (1983).

Area	Area A 3x10 nm			Area B < 5 nm			Area C 5-10 nm			Area D 10-15 nm			Area E 15-20 nm			Area F < 20 nm		
Quantity	$\langle s_A \rangle$	VarA	VarB	$\langle s_A \rangle$	VarA	VarB	$\langle s_A \rangle$	VarA	VarB	$\langle s_A \rangle$	VarA	VarB	$\langle s_A \rangle$	VarA	VarB	$\langle s_A \rangle$	VarA	VarB
Units	(m ² /nm ²)	%	%	(m ² /nm ²)	%	%	(m ² /nm ²)	%	%	(m ² /nm ²)	%	%	(m ² /nm ²)	%	%	(m ² /nm ²)	%	%
Total before shooting	116.3	8.7	8.5	130.5	5.8	6.7	127.8	7.4	9.8	127.8	4.5	5.5	132.5	4.3	4.7	129.8	2.8	5.4
Pelagic before shooting	79.0	11.1	10.6	90.3	7.3	8.6	90.1	9.7	13.5	87.2	5.3	6.7	95.0	5.3	5.8	90.9	3.5	7.6
Bottom before shooting	37.3	6.7	5.4	40.2	4.7	4.2	37.7	6.4	7.2	40.6	8.4	8.4	37.4	6.1	6.1	38.9	3.2	10.0
N	63			132			117			111			137			497		
Areal nm ²	30			78.5			235.6			392.7			549.8			1256.6		
DG	11.5			14.9			7.6			5.6			5.8			14.0		

Table 4.1.2. Acoustic measurements of average fish density of cod and haddock during the shooting, computed for each region in Fig. 3.2.3 and for the total region (F), expressed in terms of the average area backscattering coefficient $\langle s_A \rangle$, with the variance computed using ordinary statistics and geostatistics, respectively, expressed as a percentage of the average. The number of mile-intervals used in each area (N), area, and degree of coverage (DG) are given. The degree of coverage is computed according to Aglen (1983).

Area	Area A 3x10 nm			Area B < 5 nm			Area C 5-10 nm			Area D 10-15 nm			Area E 15-20 nm			Area F < 20 nm		
	$\langle s_A \rangle$	VarA	VarB	$\langle s_A \rangle$	VarA	VarB	$\langle s_A \rangle$	VarA	VarB	$\langle s_A \rangle$	VarA	VarB	$\langle s_A \rangle$	VarA	BarB	$\langle s_A \rangle$	VarA	VarB
Units	(m ² /nm ²)	%	%	(m ² /nm ²)	%	%	(m ² /nm ²)	%	%	(m ² /nm ²)	%	%	(m ² /nm ²)	%	%	(m ² /nm ²)	%	%
Total during shooting	65.4	5.5	4.9	62.8	3.9	5.0	72.2	3.4	3.4	82.6	4.1	4.9	78.6	4.3	4.7	72.0	2.1	8.0
Pelagic during shooting	39.4	6.1	5.1	40.0	4.1	5.9	49.5	3.9	4.0	56.8	5.1	6.6	54.3	5.1	6.9	48.4	2.3	10.9
Bottom during shooting	26.1	8.2	8.2	22.8	6.0	6.0	22.7	4.0	4.0	25.8	5.1	5.1	24.4	6.5	6.5	23.7	2.9	2.9
N	99			226			149			119			121			615		
DG	18.1			25.5			9.7			6.1			5.1			17.0		

Table 4.1.3. Acoustic measurements of average fish density of cod and haddock after the shooting ended, computed for each region in Fig. 3.2.3 and for the total region (F), expressed in terms of the average area backscattering coefficient $\langle s_A \rangle$, with the variance computed using ordinary statistics and geostatistics, respectively, expressed as a percentage of the average. The number of mile-intervals used in each area (N), area, and degree of coverage (DG) are given. The degree of coverage is computed according to Aglen (1983).

Area	Area A 3x10 nm			Area B < 5 nm			Area C 5-10 nm			Area D 10-15 nm			Area E 15-20 nm			Area F < 20 nm		
	$\langle s_A \rangle$	VarA	VarB	$\langle s_A \rangle$	VarA	VarB	$\langle s_A \rangle$	VarA	VarB	$\langle s_A \rangle$	VarA	VarB	$\langle s_A \rangle$	VarA	VarB	$\langle s_A \rangle$	VarA	VarB
Units	(m ² /nm ²)	%	%	(m ² /nm ²)	%	%	(m ² /nm ²)	%	%	(m ² /nm ²)	%	%	(m ² /nm ²)	%	%	(m ² /nm ²)	%	%
Total after shooting	48.4	4.9	4.8	46.9	3.3	3.4	45.9	4.3	4.2	46.3	4.2	4.4	46.1	2.9	4.7	46.2	1.8	3.7
Pelagic after shooting	26.6	6.5	6.6	26.4	4.4	4.2	26.7	4.3	4.0	28.0	4.4	4.3	28.4	3.3	5.1	27.6	2.0	3.0
Bottom after shooting	21.7	5.5	5.8	20.6	4.3	4.7	19.1	7.0	7.2	18.2	6.6	7.2	17.7	4.0	5.8	18.6	2.6	4.7
N	56			105			95			94			232			526		
DG	10.2			11.8			6.1			4.7			9.9			14.8		

nautical miles from the center of the shooting area and in the northwest. A reasonably good picture of the distribution pattern during the shooting is given by a transect running through the shooting area in an east-west direction on 9 May (Fig. 4.1.4), with the lowest density within the actual shooting area, or 5 nautical miles to each side from the center, with gradually increasing density to each side. In the period after the shooting (Fig. 4.1.3), a further reduction in the total quantity occurred, but also accompanied by a gradual smoothing of the horizontal distribution.

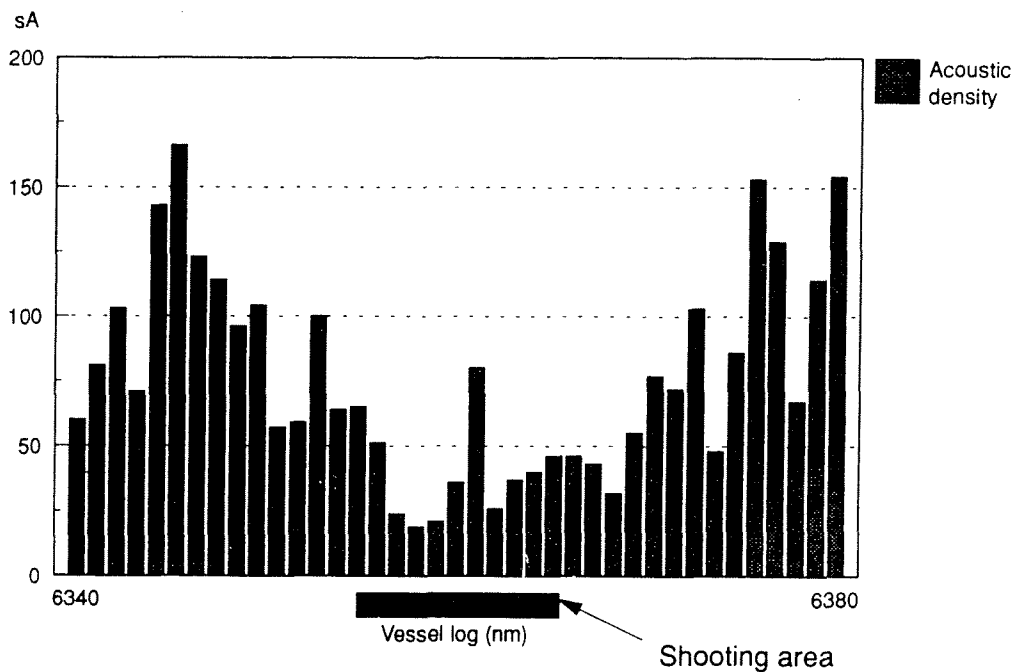

Figure 4.1.4. Total echo integrator values for cod and haddock, with 1-nautical-mile resolution, measured along a straight transect running through the center of the area in an east-west direction during the shooting on 9 May. The vessel log is shown on the x-axis.

A better picture of the actual effect on the total acoustic quantity of cod and haddock can be obtained by splitting the data up radially, without considering horizontal differences in density. This is done in Fig. 4.1.5 for the total area and in Fig. 4.1.6 for circular belts, or annuli (see also Tables 4.1.1-4.1.3 where the acoustic data are summed up by area and time). The total acoustic density for the entire area was reduced from an average of 129.8 to 72.0 during the shooting, or by 45%. During the period after the shooting the average value was 46.2, which corresponds to a reduction from the initial situation by 64%. A distinct distance effect was present during the shooting, with lower density than the average within 5 nautical

miles of the center and within the shooting area itself, and with higher density beyond 10 nautical miles from the center (Fig. 4.1.6). This effect disappeared after the shooting, when the density was roughly constant at all distances.

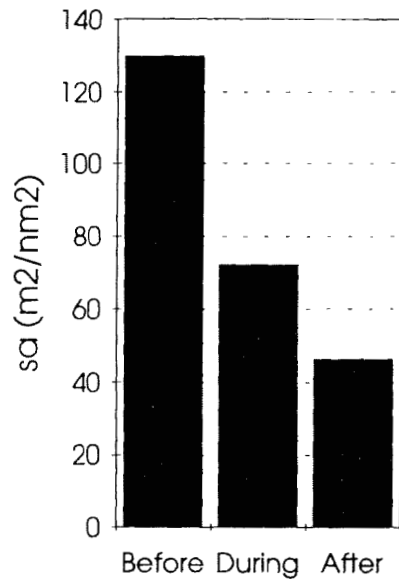

Figure 4.1.5. Total acoustic density within the entire survey region before, during and after shooting.

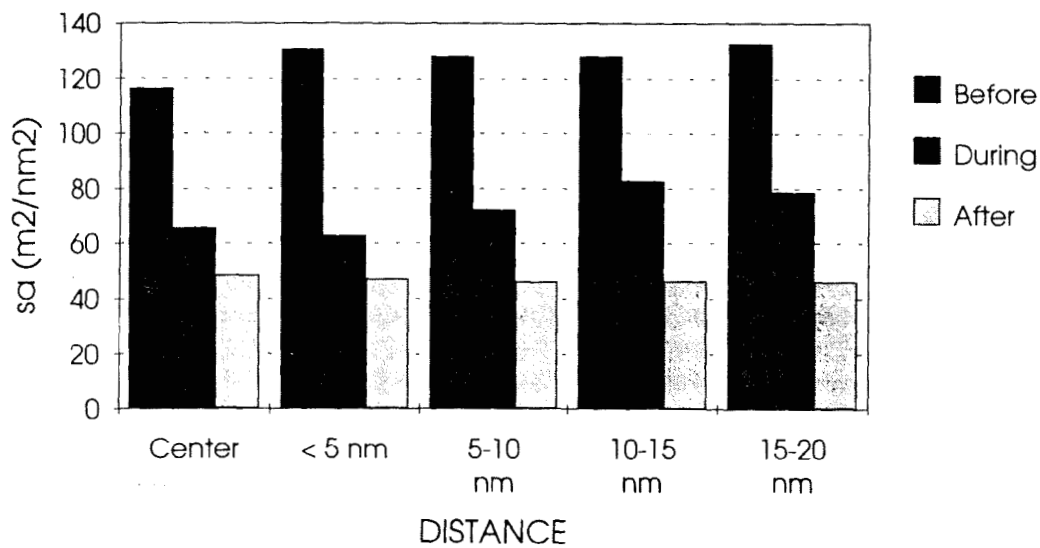

Figure 4.1.6. Total acoustic density distributed by distance from the shooting region before, during and after shooting.

Vertically, the reduction was greater in the pelagic part of the water column than in the bottom channel, respectively 47 and 39% (Fig. 4.1.7). This can signify that part of the fish, which before the shooting was found immediately over the bottom channel, was pressed down into this during the shooting. The main tendency, nonetheless, was a horizontal transport of fish out of the area, with a substantial reduction of the total density.

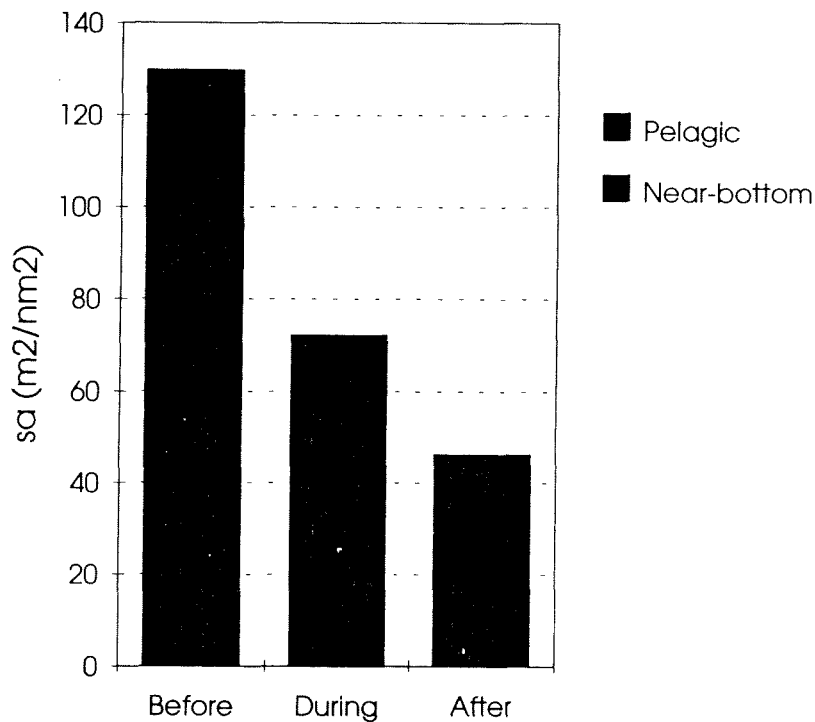

Figure 4.1.7. Acoustic density values separated into pelagic and near-bottom parts.

The acoustic measure for density cannot be directly converted to a quantity in tons or to a number, since large fish make a relatively larger contribution to this measure than do small fish. Here, information on both length and species distributions of the cod and haddock in the sampling trawl is employed to convert the acoustic measure to absolute number distributions, and further to weight for both species. This process is described in more detail in Appendix A.

The abundance computations showed that initially there were about 33000 tons of cod and 6000 tons of haddock distributed over the entire investigation area of 1257 square nautical

miles, or 31 tons of fish per square nautical mile. Apportionment of the total weight by area was performed in proportion to the acoustic density measurements for the same area and period, such that within the shooting area of 3 x 10 square nautical miles, there were 834 tons of cod and haddock (before shooting), of which 85% were cod. Expressed in terms of weight for the entire area, the quantity of cod was reduced from 33000 tons before shooting to 16500 tons during shooting, and further to 9700 tons after shooting (Fig. 4.1.8). The quantity of haddock for the same area was reduced from 6000 tons to 3200 tons during the shooting and to 3100 tons after the shooting.

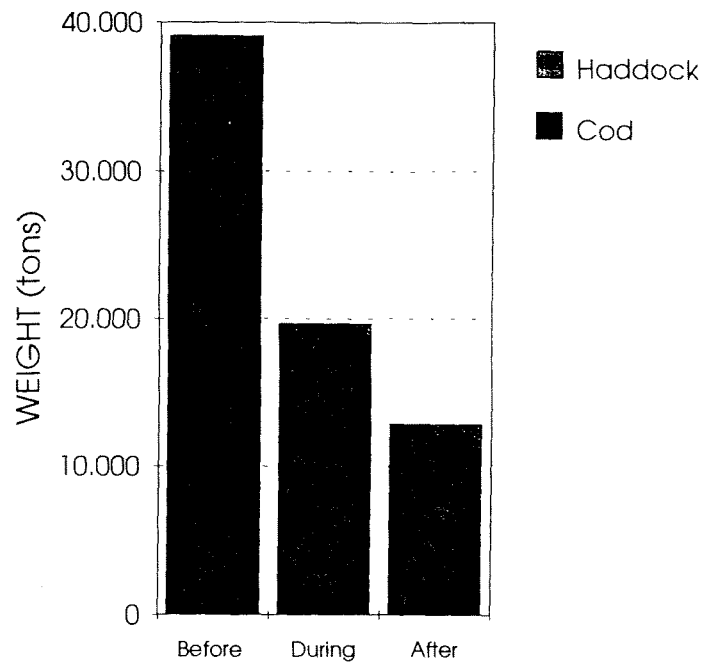

Figure 4.1.8. Total quantity of cod and haddock by weight before, during and after shooting.

The number distribution for both species in all three periods (Fig. 4.1.9) shows a weaker reduction than does the weight distribution, which is clearly reflected in the length distributions from the catches (Figs. 4.1.10 and 4.1.11). It is evident that cod larger than 60 cm contributed more to the weight reduction than did smaller fish (Fig. 4.1.12). The same was the case for haddock larger than 30 cm.

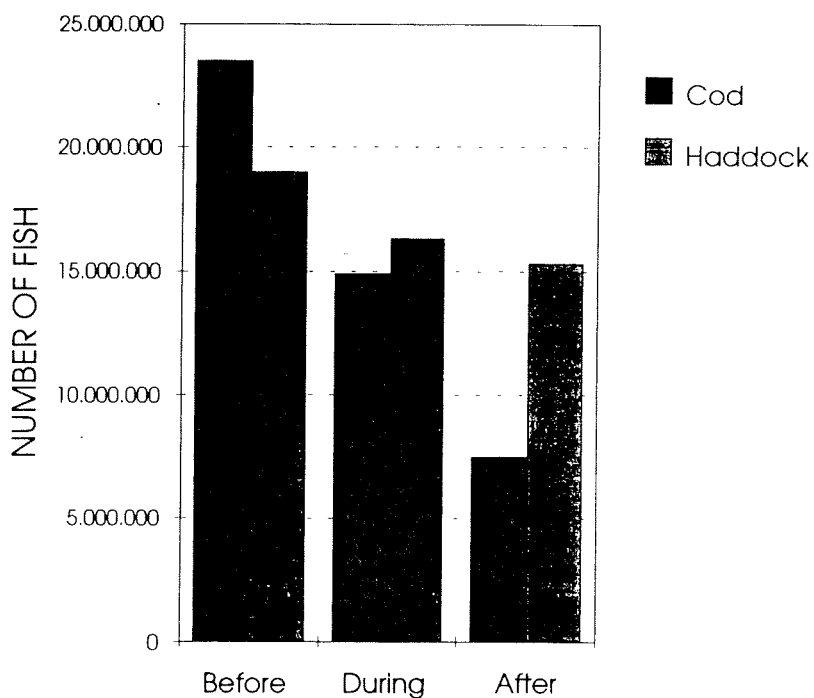

Figure 4.1.9. Total number of cod and haddock before, during and after shooting.

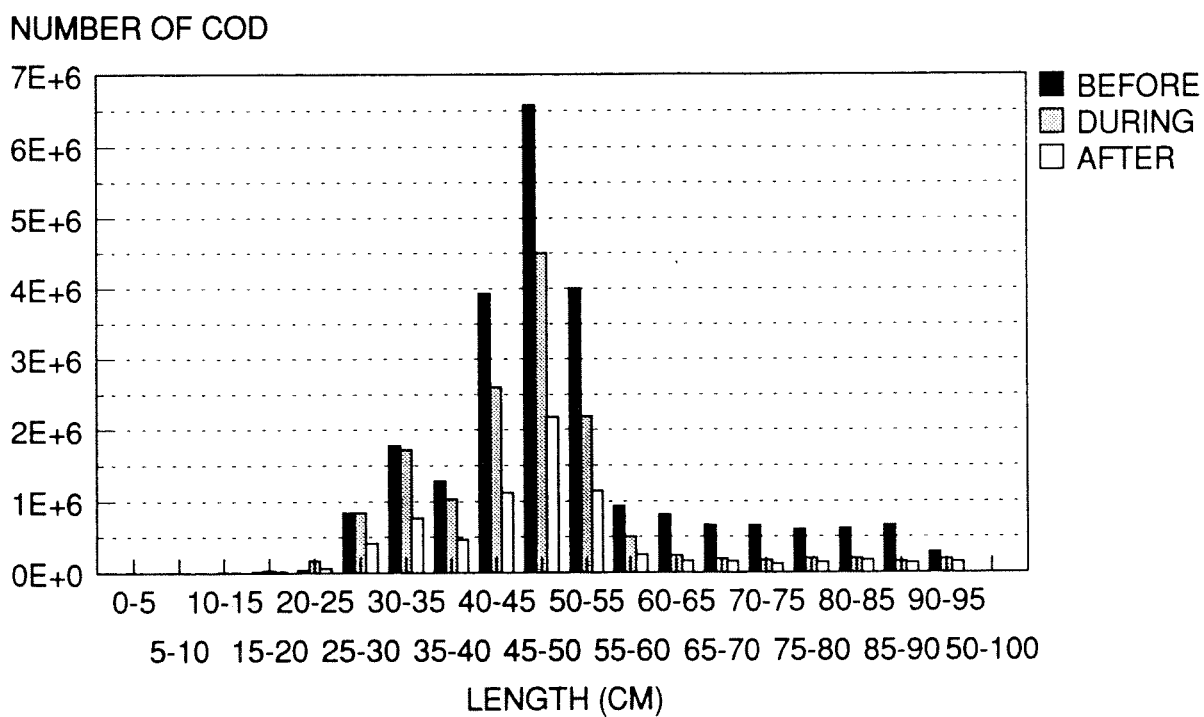

Figure 4.1.10. Length distribution of cod from the sampling trawl before, during and after shooting. The following stations are combined: Before: nos. 1-14, During: nos. 15-60, After: nos. 62-94.

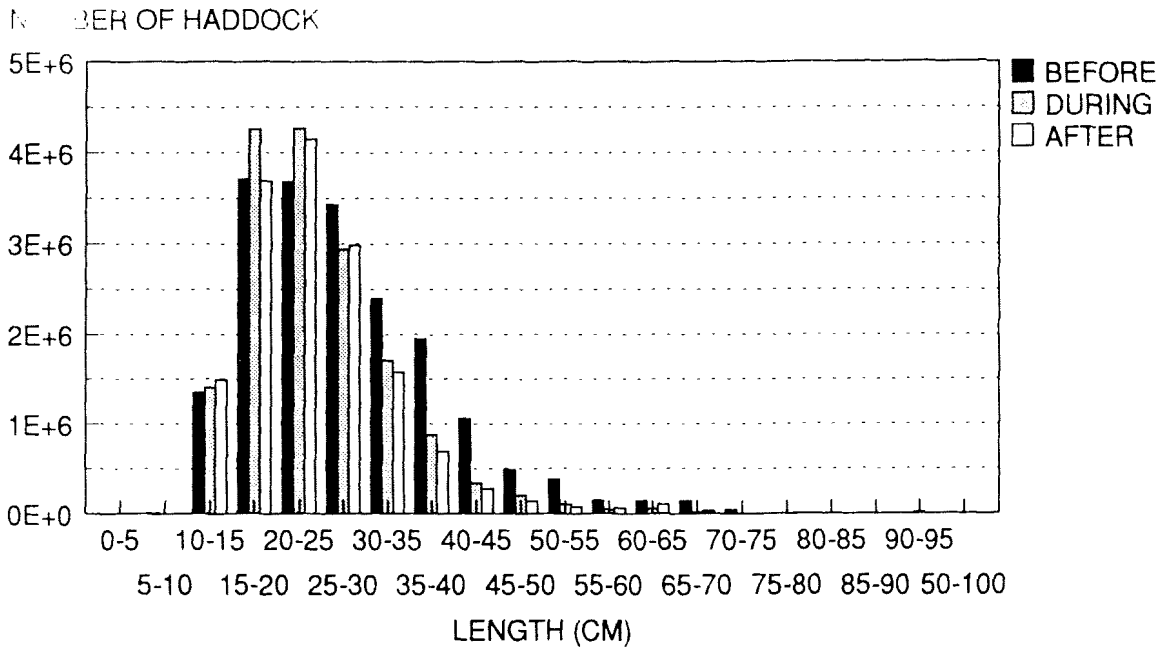

Figure 4.1.11. Length distribution of haddock from the sampling trawl before, during and after shooting. The following stations are combined: Before: nos. 1-14, During: nos. 15-60, After: nos. 62-94.

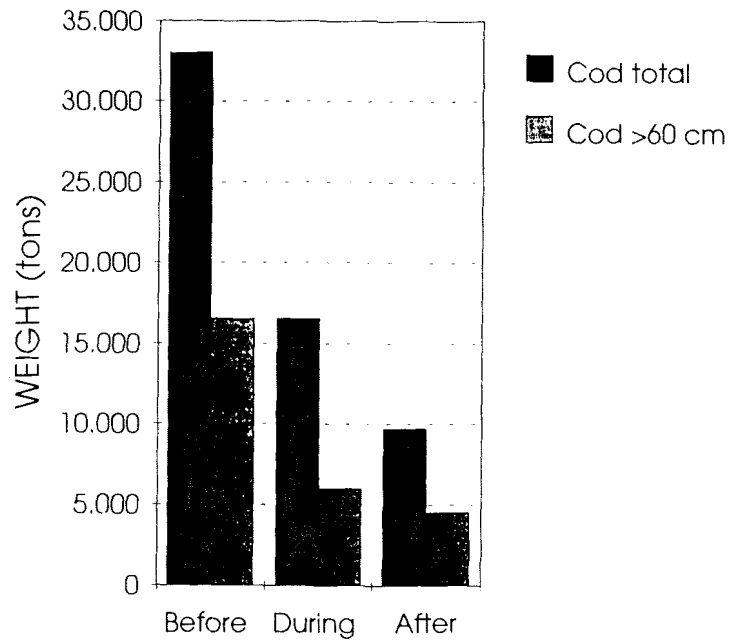

Figure 4.1.12. Relative, weight-based proportion of cod larger than 60 cm caught in the sampling trawl before, during and after shooting.

A finer time resolution for the whole period (Fig. 4.1.13), where the average value for acoustic density is computed for each day, shows that the fish quantity in the area was stable and high, without any tendency toward change in the period before shooting, with a maximum value on the day before the shooting, 7 May. The effect of the seismic shooting was immediate, and so rapid that the decline itself could just be registered by acoustics. During the actual shooting there was a clear trend in the data toward lower density values, with a leveling in the distribution during the period after the shooting.

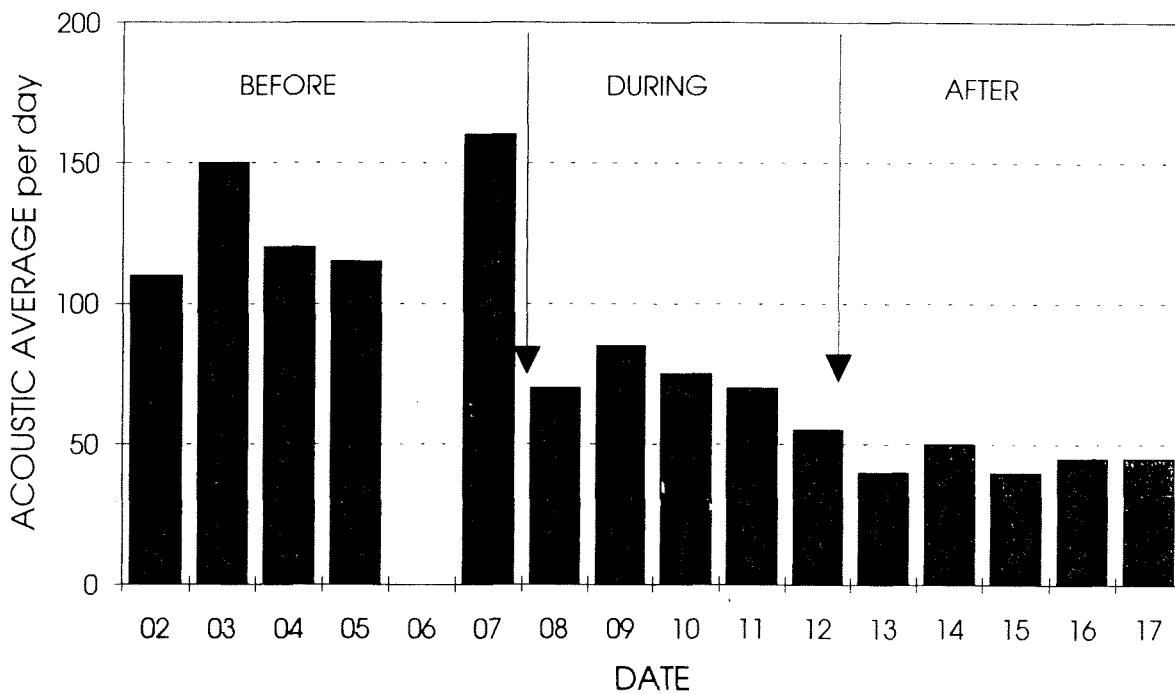

Figure 4.1.13. Average daily acoustic quantity, independent of position, throughout the whole period, 1-17 May 1992. The gap in the record on 6 May is due to a meeting with the seismic vessel in Hammerfest.

4.2 Trawl catches

Catch size

Cod constituted the major part of the catches both by trawl and by longline. On the trawler "ANNY KRÆMER" more than 90% of the average catch was cod. The next most important species was haddock. In addition, specimens of saithe, redfish, spotted catfish, blue catfish, lumpsucker, Greenland halibut, long rough dab and skate were occasionally caught.

Figure 4.2.1 and Table 1 in Appendix E show the average weight of cod per haul on board "ANNY KRÆMER" before, during and after the shooting, combined according to distance from the shooting area. The results from the statistical analyses are shown in Appendix F. The catches were significantly higher before the shooting began than during or after the shooting at all distances from the shooting area (Appendix F, Table 1). The reduction was largest within the shooting area, where the average catch of cod decreased from 556 (± 56) kg before shooting to 173 (± 19) kg during and 202 (± 14) kg after shooting. The catch rate for cod during the shooting was accordingly reduced by 71% from the level before shooting. Also in the hauls that were taken 1-3, 7-9 and 16-18 nautical miles from the central area, the reduction in catch was significant. Here the reduction was 45-50% relative to that before shooting. It is further evident from the figure that there was no increase in the catch rates of cod after the shooting ceased.

The catches of haddock constituted less than 10% of the total catch quantity. Still, the catches of haddock were significantly less during and after the shooting than before the shooting began (Appendix F, Table 2). Within the shooting area the catches during the shooting were reduced by 68% relative to those before the shooting (Fig. 4.2.2 and Appendix E, Table 2). In addition, the catches at other distances were significantly less during and after shooting. Here the reduction during shooting relative to that before shooting was respectively 56%, 56% and 70% at 1-3, 7-9 and 16-18 nautical miles. Similarly for haddock, there was no-increase in catch rates after the shooting ended.

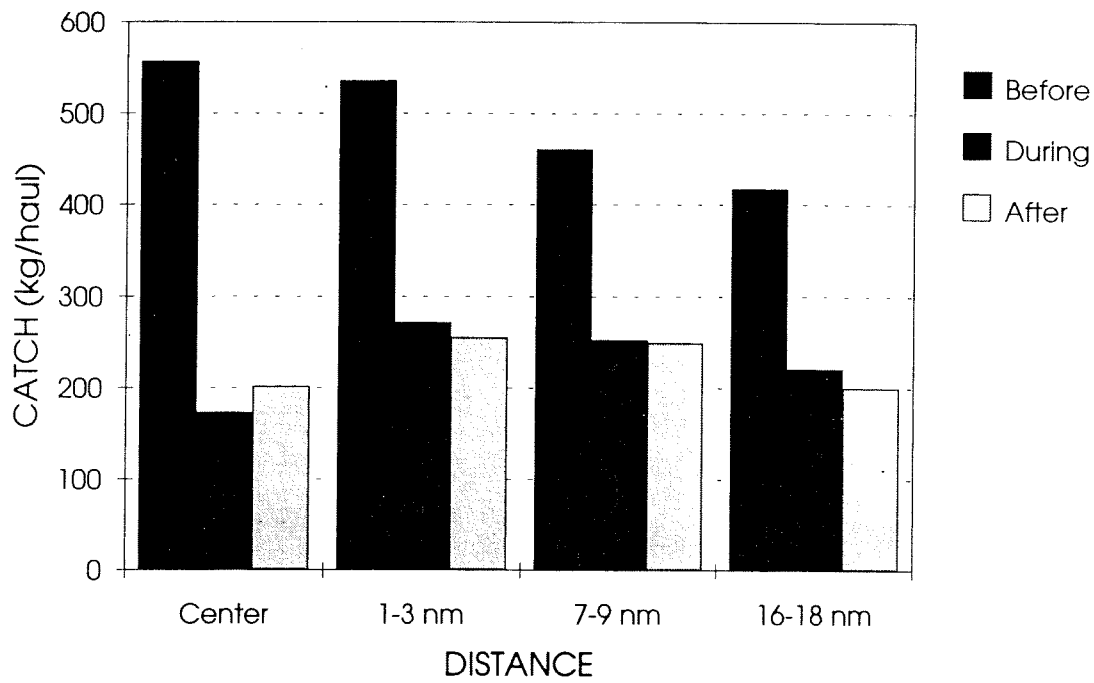

Figure 4.2.1. Average trawl-catch rate for cod before, during and after shooting, arranged by distance from the shooting area.

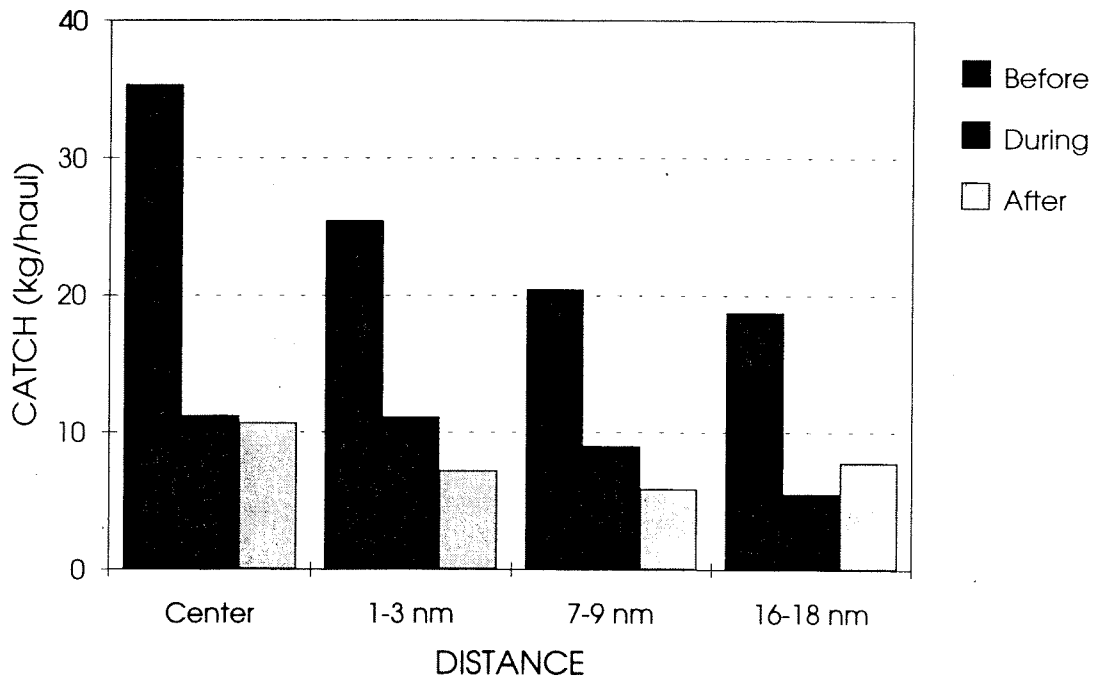

Figure 4.2.2. Average trawl-catch rate for haddock before, during and after shooting, arranged by distance from the shooting area.

Figures 4.2.3 and 4.2.4 show the time series of catch rates for cod and haddock by trawl, where the catches are shown as a deviation from the grand average for the entire trial period. The trawl hauls are drawn in chronological order without regard to distance from the shooting area. The figures show that there was a significant variation in catch quantity from haul to haul throughout the entire trial period, but it is nevertheless clear that the catch rate fell immediately after the start of shooting. The low level was maintained throughout the whole shooting period (hauls 63-130) and also in the days after the seismic shooting had ceased. The time pattern was quite similar for cod and haddock, notwithstanding the lower catch rates for haddock. The sudden reduction in catch, which is apparent from the time series, coincided with the start of shooting for both species.

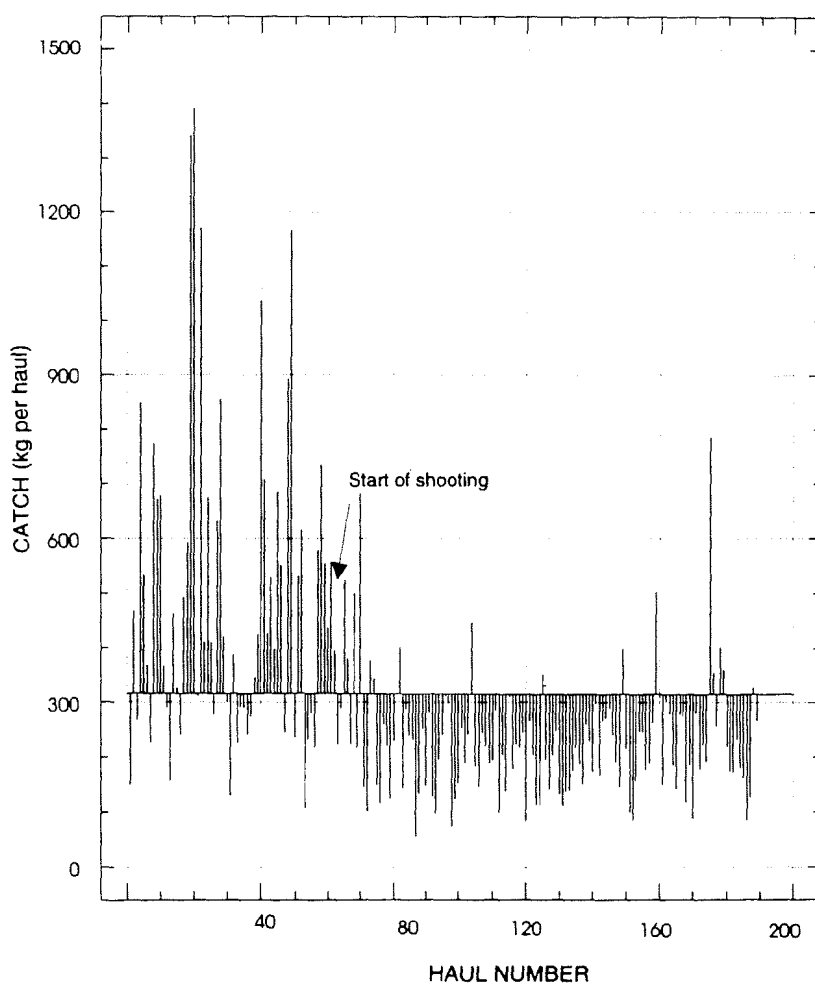

Figure 4.2.3. Trawl-catch rates for cod with "ANNY KRÆMER", arranged in chronological order. The catches are shown relative to the average (horizontal line) over the entire trial period.

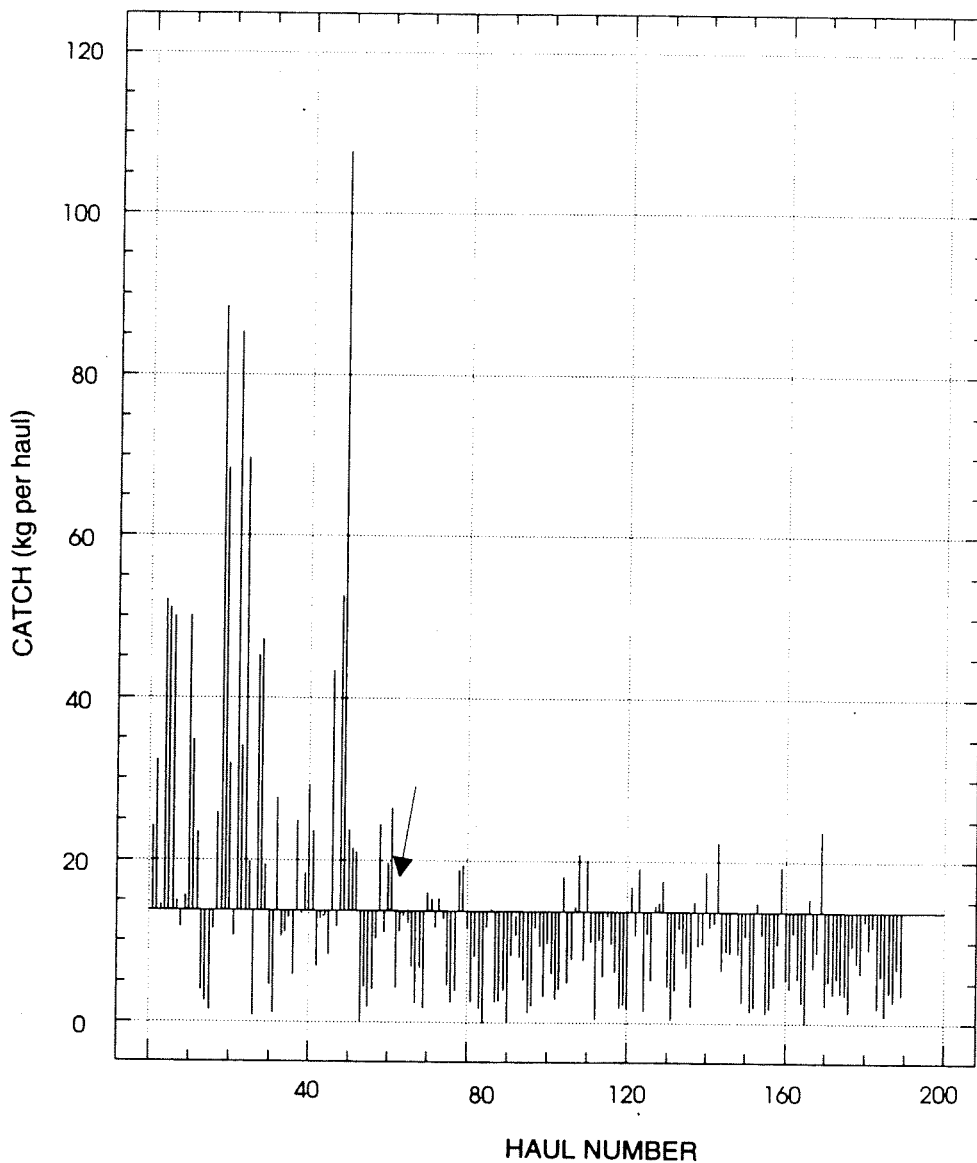

Figure 4.2.4. Trawl-catch rates for haddock with "ANNY KRÆMER", arranged in chronological order. The catches are shown relative to the average (horizontal line) over the entire trial period.

Length distribution and number of fish in the catch

The number reduction in the catches was considerably less than the weight reduction (Figs. 4.2.5 and 4.2.6). While the weight reduction for cod within the shooting area was 71%, and about 50% out to 18 nautical miles from the shooting area, the reduction in number was 46%

in the center and 35-50% in the surrounding areas. For haddock there was a persistent 5% greater reduction in weight than in number over the entire trial area.

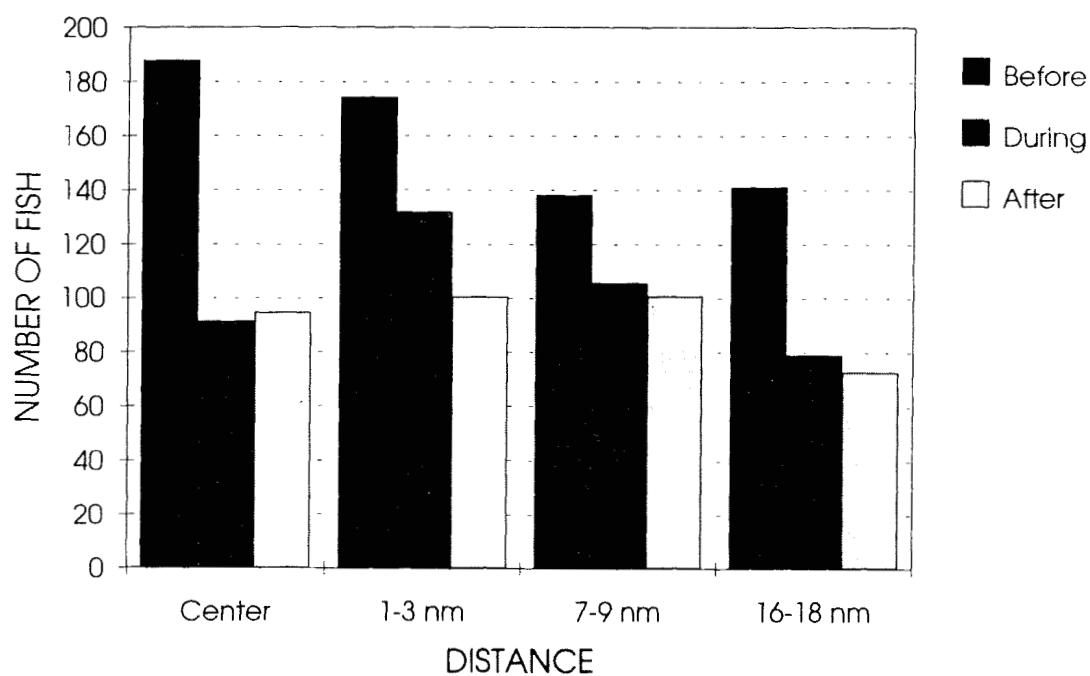

Figure 4.2.5. Average number of cod in the trawl hauls before, during and after shooting, arranged by distance from the shooting area.

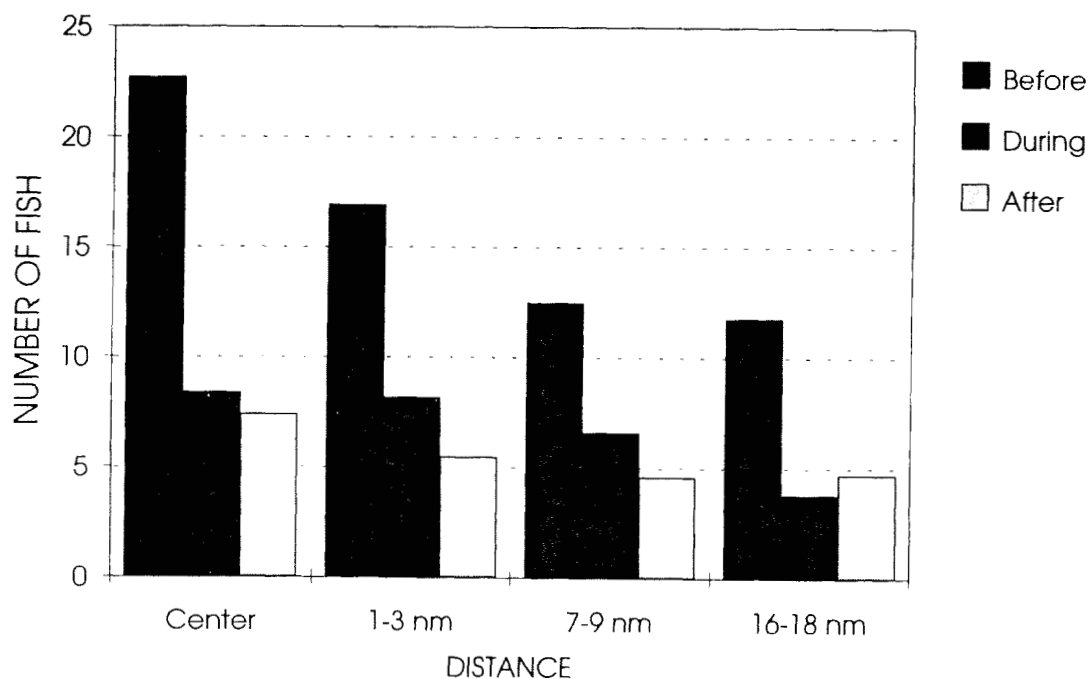
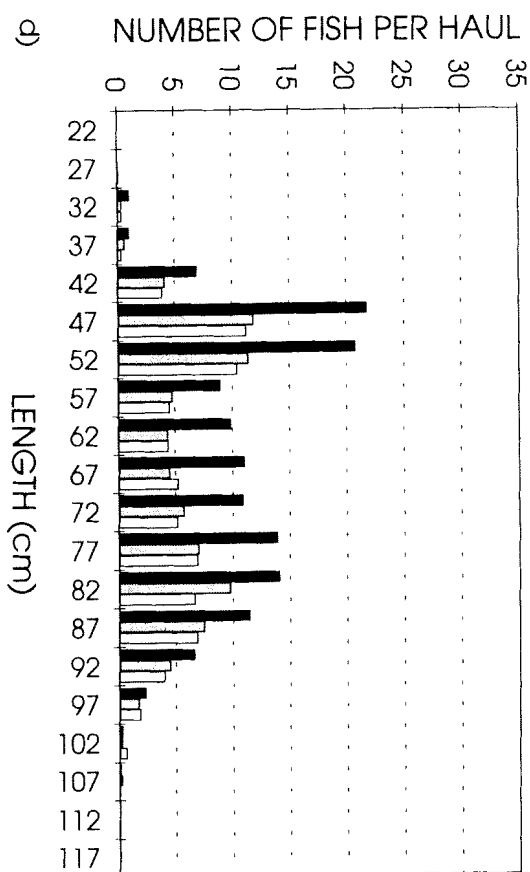
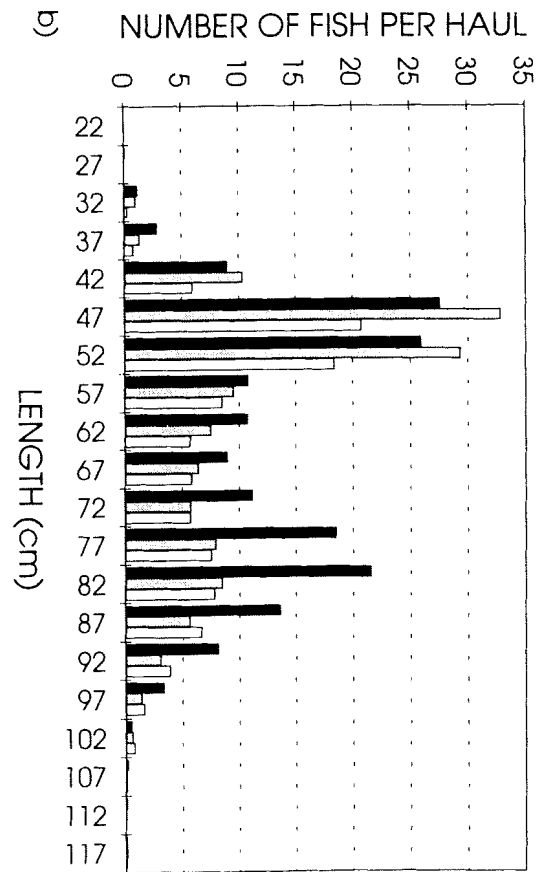
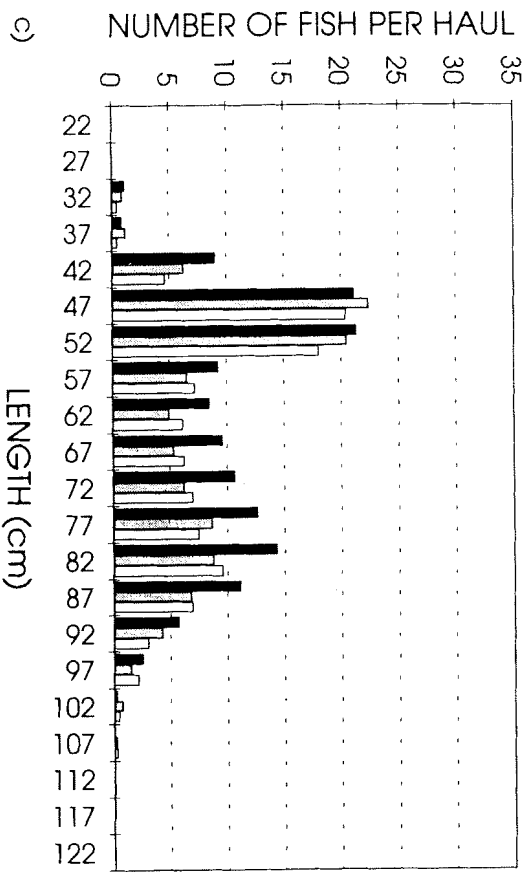
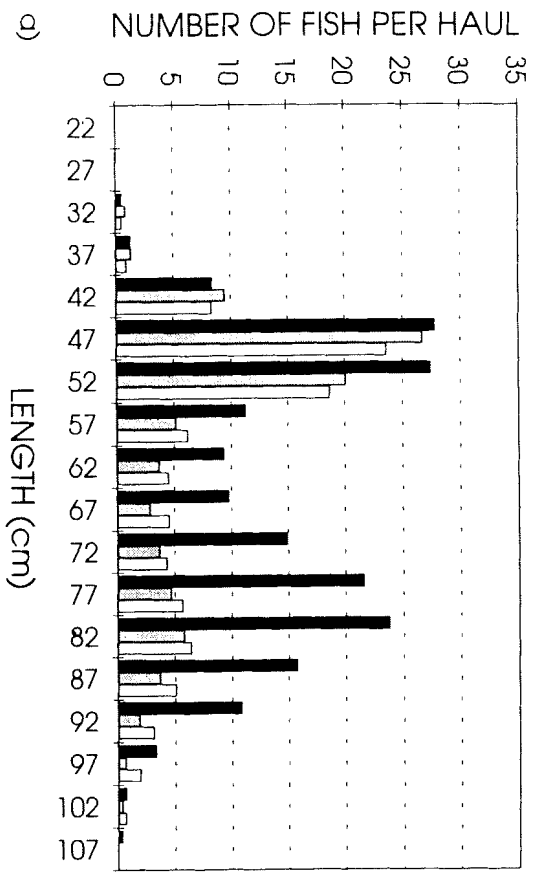

Figure 4.2.6. Average number of haddock in the trawl hauls before, during and after shooting, arranged by distance from the shooting area.

Figures 4.2.7 and 4.2.8 show length distributions of cod and haddock. The greatest part of cod that was caught with commercial trawl was between 40 and 100 cm in length. The length distribution of cod before shooting was distinctly bimodal (with two peaks), with a maximum at about 50 cm and another peak at roughly 80 cm. The length spectrum for haddock was less, with the main part between 35 and 70 cm. The length distribution graph for haddock also shows a tendency toward bimodality, if less distinct than for cod, with peaks at roughly 50 and 60 cm. The length distributions of both cod and haddock changed throughout the trial period. The changes were greatest within the shooting area, with a gradual reduction toward the border of the trial area. The sharpest change for cod occurred at the upper peak (from about 60 cm and longer), which nearly disappeared. The changes for fish under 60 cm were less. For haddock the reduction in all size groups was more even (Figs. 4.2.8a-d).

The observed changes in length distribution when the seismic shooting began explain why the weight reduction in the catches was greater than the number reduction. In Figures 4.2.9 a and b and 4.2.10 a and b (also Appendix E, Tables 3 and 4) the catch of cod and haddock is divided into two length groups, small (<60 cm) and large (≥ 60 cm), in accordance with the two-peaked length distribution for cod. The number of small cod was moderately reduced under the influence of the air guns. For large fish, however, which affect the weight of the catches to the largest degree, there was a large reduction in the number when the shooting began. Within the shooting area the number of large cod per trawl haul was on average 110 ± 11.4 before the shooting. After the onset of shooting, the number fell to 27 ± 3.2 . In addition, for the hauls that were taken at different distances outside of the shooting area, there was a significant reduction in the number of large cod. For haddock the reduction was distributed over the entire length spectrum (Appendix E, Table 4) at all distances from the shooting area, but also here the reduction was somewhat larger for large fish.

That large and small fish react differently to seismic shooting also causes changes in the average individual weight of fish in trawl catches throughout the trial period. The average weight of cod and haddock is shown in Figs. 4.2.11 and 4.2.12 (also Appendix F, Tables 5 and 6). Before the shooting began, the size of cod was relatively uniform over the entire



■ Before
 ▨ During
 □ After

Figure 4.2.7. Length distribution of cod in trawl hauls before, during and after shooting. (a) Within the shooting area, (b) at 1-3 nautical miles, (c) at 7-9 nautical miles, (d) at 16-18 nautical miles.

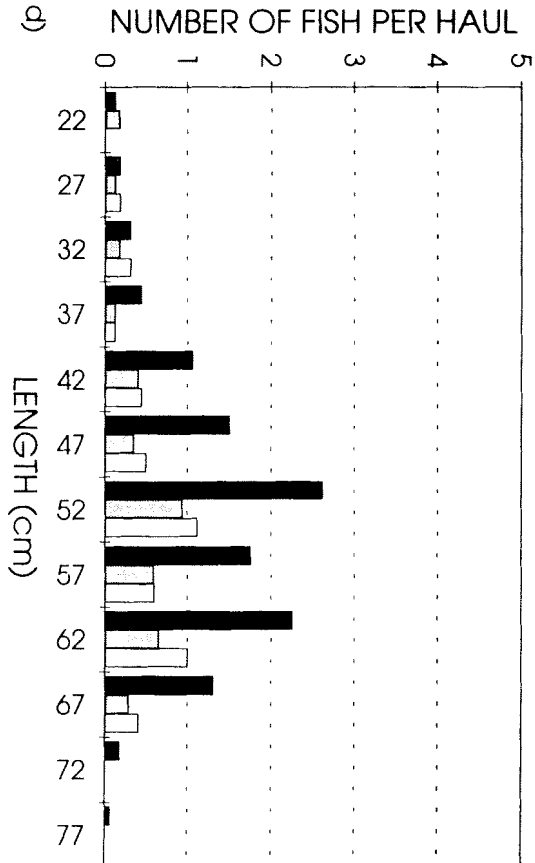
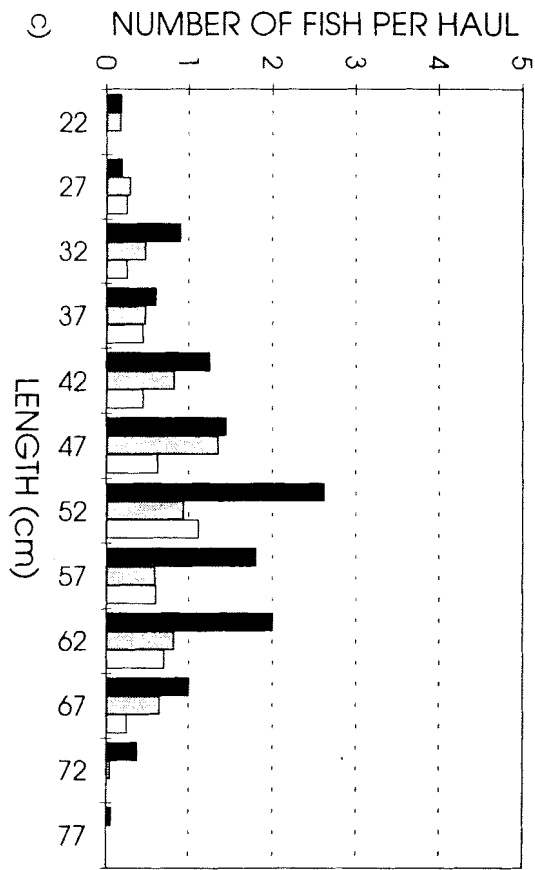
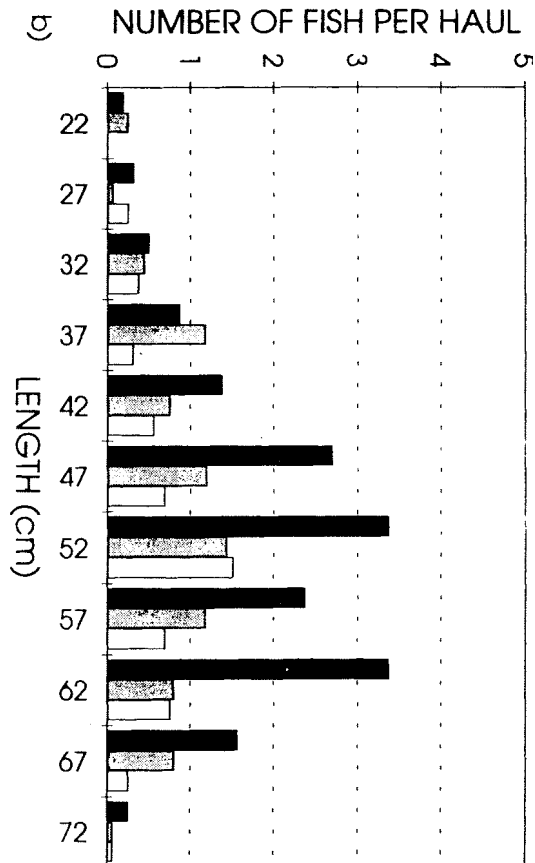
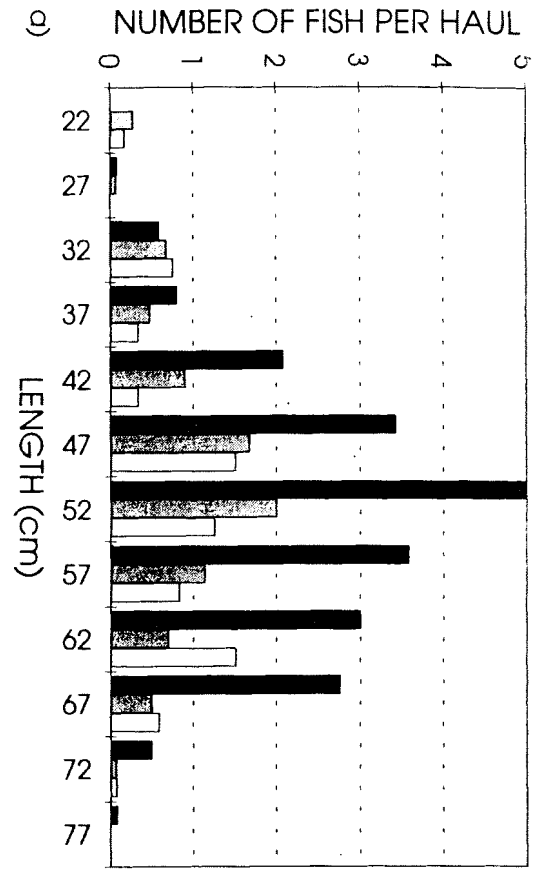
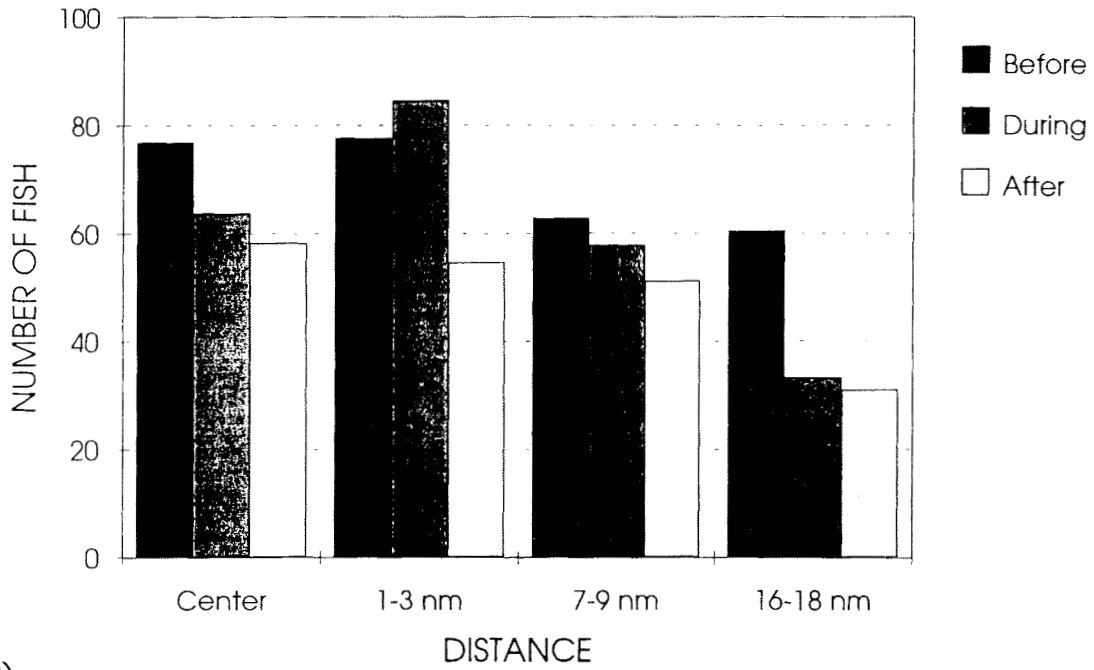
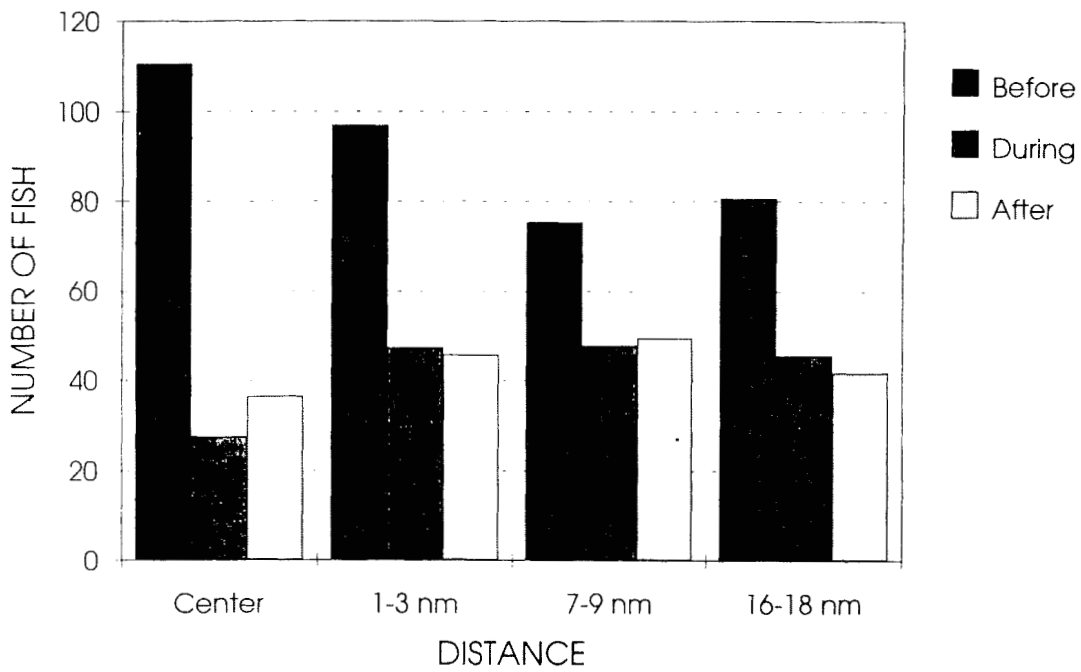

Figure 4.2.8. Length distribution of haddock in trawl hauls before, during and after shooting. (a) Within the shooting area, (b) at 1-3 nautical miles, (c) at 7-9 nautical miles, (d) at 16-18 nautical miles.



a)



b)

Figure. 4.2.9. Number of (a) small (<60 cm) and (b) large (≥ 60 cm) cod in trawl hauls before, during and after shooting.

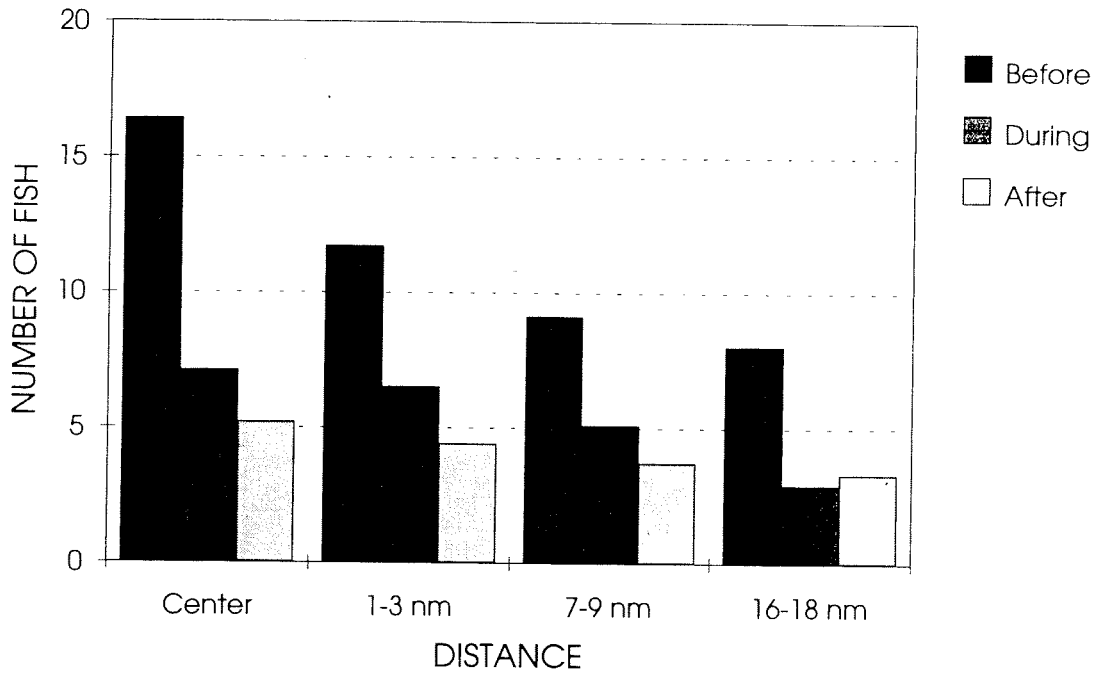

a)

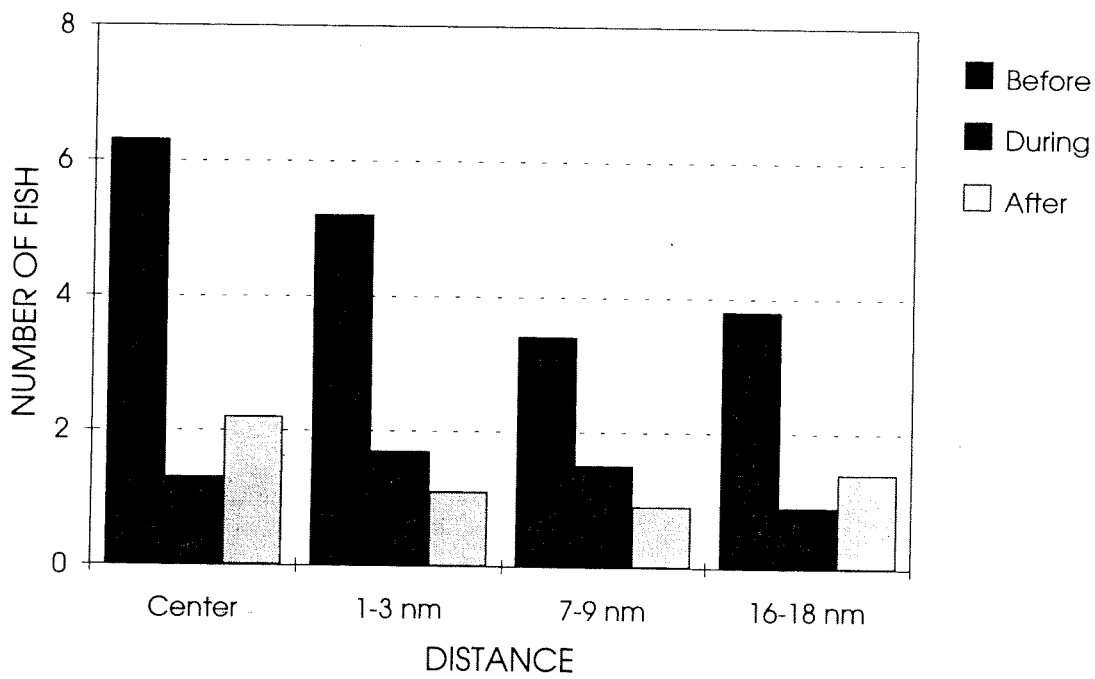

b)

Figure 4.2.10. Number of (a) small (<60 cm) and (b) large (≥ 60 cm) haddock in trawl hauls before, during and after shooting.

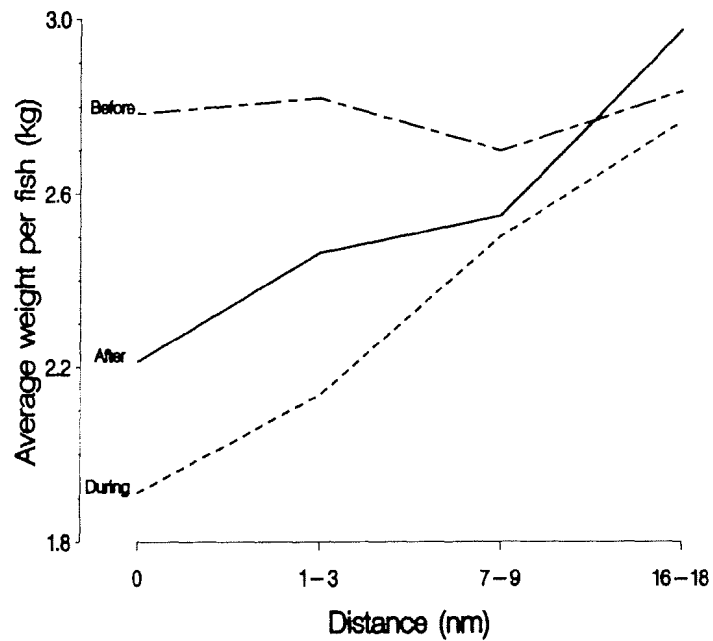

Figure 4.2.11. Average individual weight of cod in trawl hauls before, during and after shooting, arranged by distance from the shooting area.

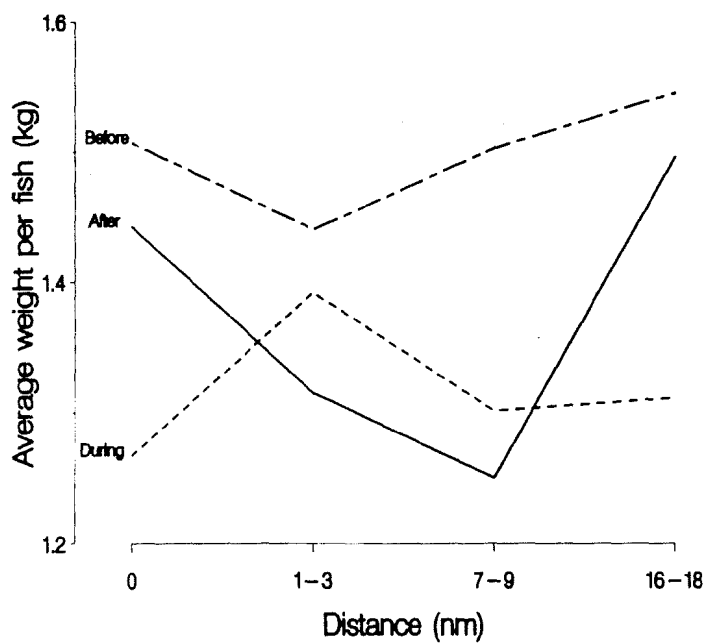

Figure 4.2.12. Average individual weight of haddock in trawl hauls before, during and after shooting, arranged by distance from the shooting area.

investigation area. After the shooting began, the weight was significantly reduced in the shooting area and in the nearby surrounding areas. The changes in the average weight gradually decreased with decreasing distance to the border of the trial area, and at the furthest position there was no significant change. Both the changes in time and differences with increasing distance from the shooting area were significant. After the shooting ceased this weight gradient from the center toward the border was lessened somewhat, which most likely signifies a return of the fish distribution to conditions before the shooting began.

The individual weight of haddock was also reduced under influence of the shooting, but throughout the entire trial area. No tendency to normalizing after cessation of the shooting was observed.

Catch in the first hauls after the start of shooting

Figures 4.2.13-4.2.16 show the catch rates for cod on "ANNY KRÆMER" the last two days before and the first two days after the start of shooting at different distances from the shooting area. The first trawl haul that was taken under influence of the seismic shooting was taken just one hour after "ACADEMIC SHATSKIY" had fired the first shot. The catch rate for this haul (haul no. 67, Fig. 4.2.13) was under one-half of the average of the period before the shooting. Within the shooting area the catches fell instantly when the shooting began and remained low for the duration of the trial period.

At the distance 1-3 nautical miles from the shooting area the effect on the catch rate was not as immediate as within the shooting area. The catches in the first two hauls taken after the shooting began (haul nos. 69 and 74 taken respectively 3 and 10 hours after the start of shooting) were indistinguishable from those taken in the pre-shooting period. Haul no. 74 even exceeded the pre-shooting average. Following this haul the catch rate rapidly declined. At the two furthest stations the reduction in catch was more gradual over the entire trial period.

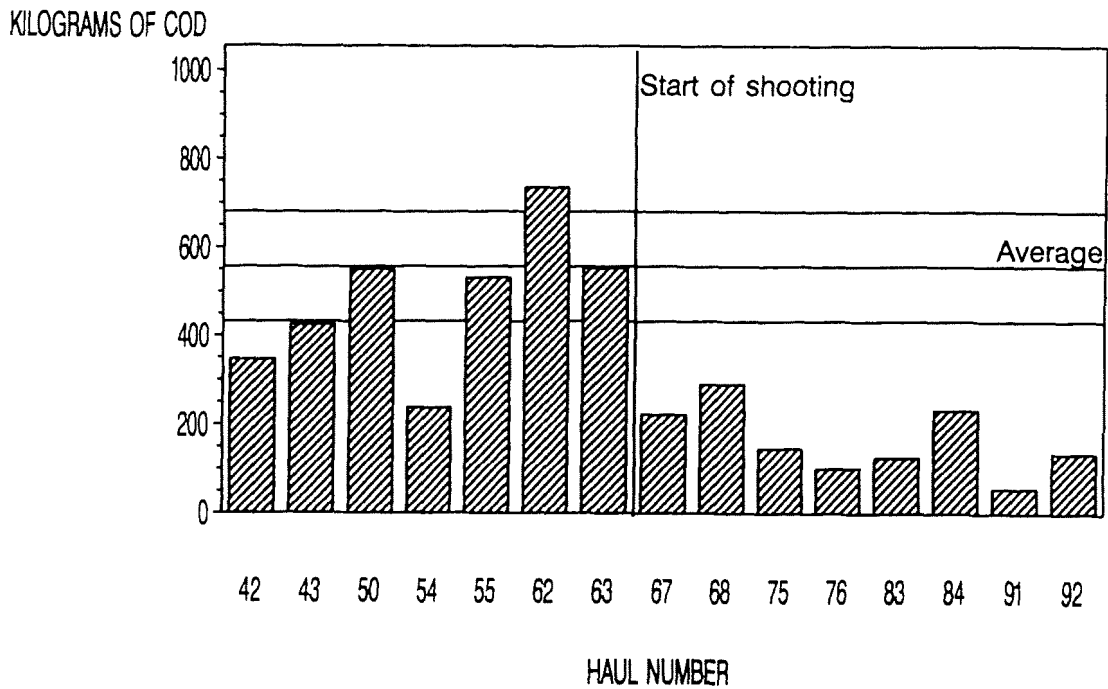

Figure 4.2.13. Catch rate for cod at distance 0 (within the shooting area) the last two days before and first two days after the start of shooting. The average and confidence interval for the catch rates before shooting are shown.

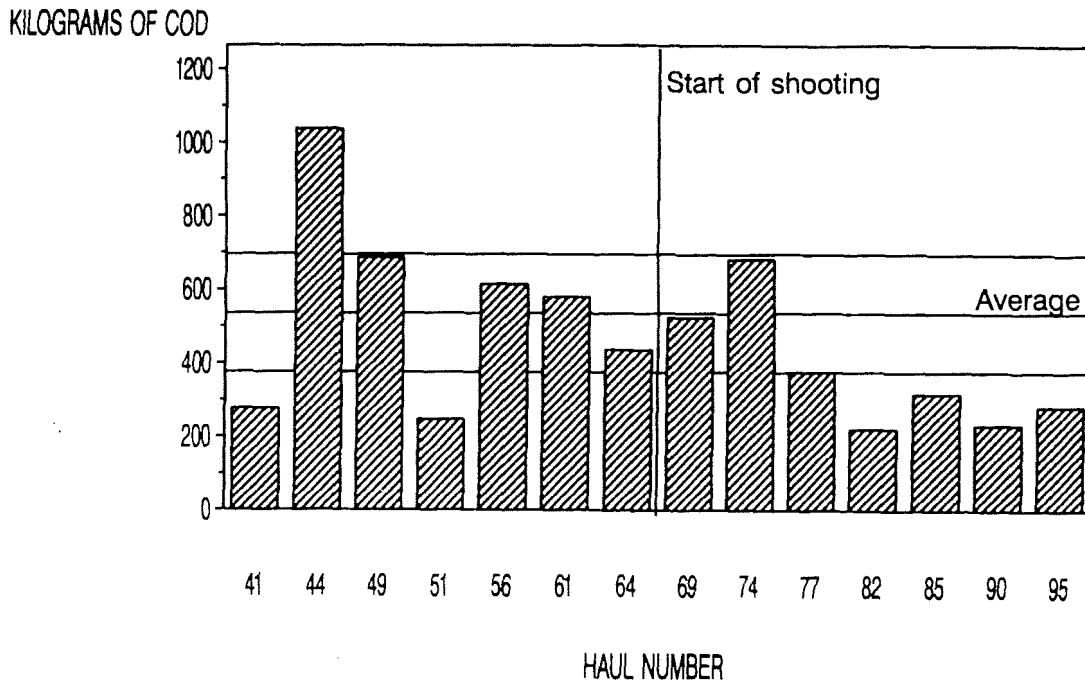

Figure 4.2.14. Catch rate for cod at distance 1 (1-3 nautical miles) the last two days before and first two days after the start of shooting. The average catch rate and associated confidence interval for the period before shooting are shown.

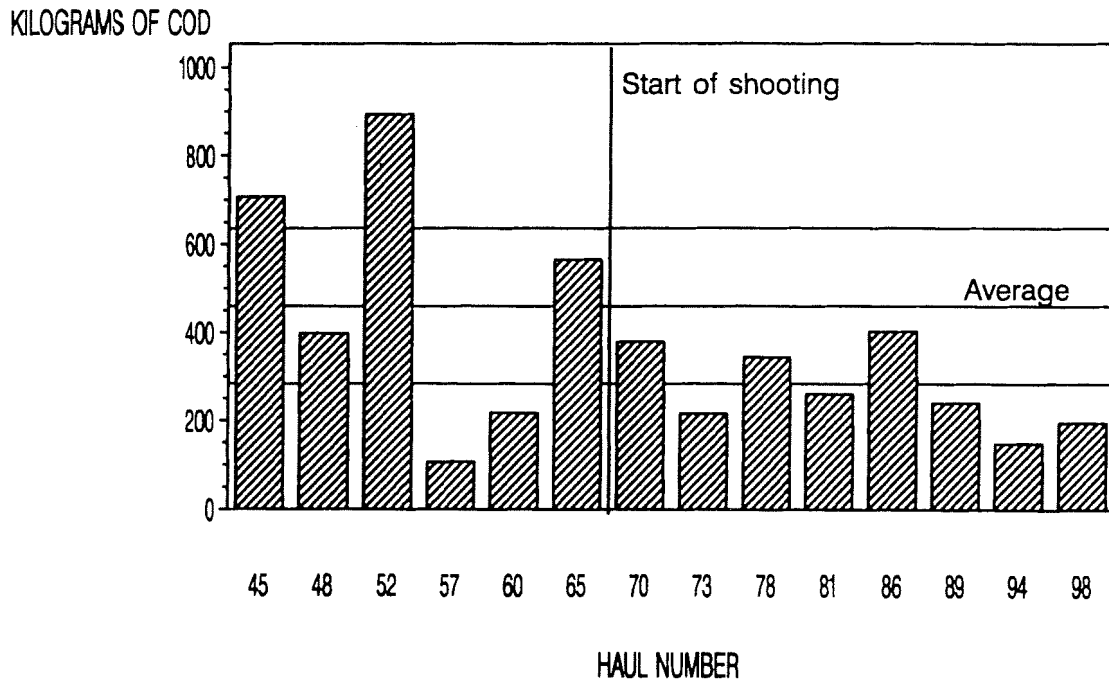

Figure 4.2.15. Catch rate for cod at distance 7 (7-9 nautical miles) the last two days before and first two days after the start of shooting. The average catch rate and associated confidence intervals for the period before shooting are shown.

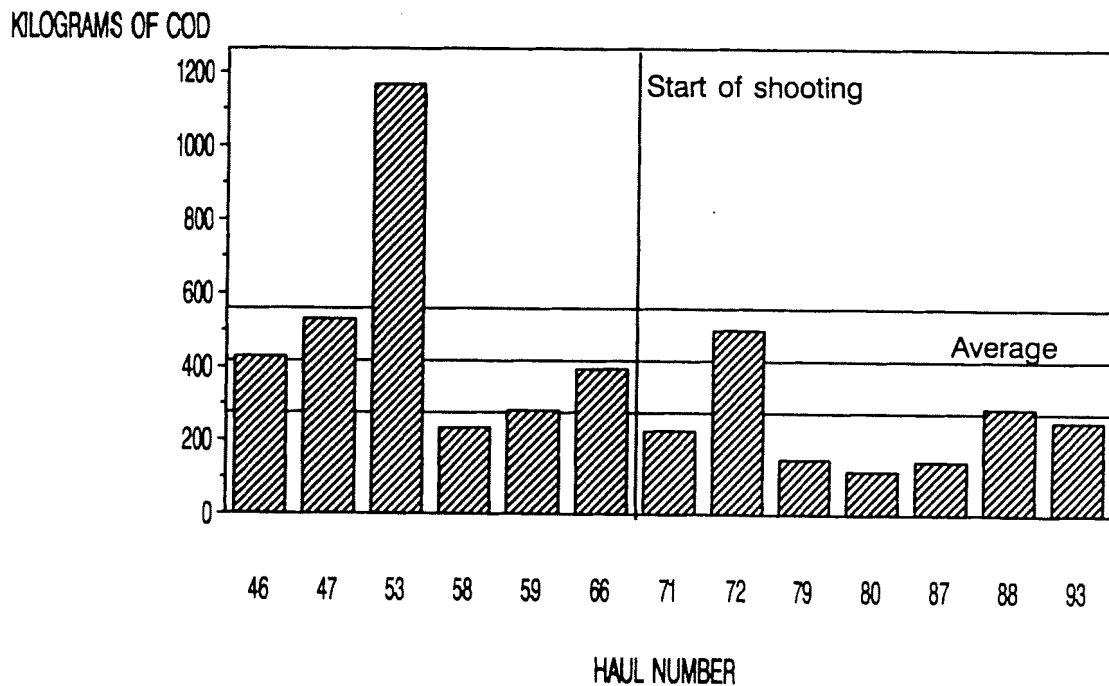

Figure 4.2.16. Catch rate for cod at distance 16 (16-18 nautical miles) the last two days before and first two days after the start of shooting. The average catch rate and associated confidence interval for the period before shooting are shown.

Other species

With the exception of long rough dab, no correlation was found between seismic shooting and the catch quantity for other species than cod and haddock. However, the catches were so small and variable that they did not provide sufficient material for a statistical analysis. The catch of long rough dab seemed to be reduced during shooting (Fig. 4.2.17). The number was approximately halved when the shooting began, but continued to decline after conclusion of the shooting.

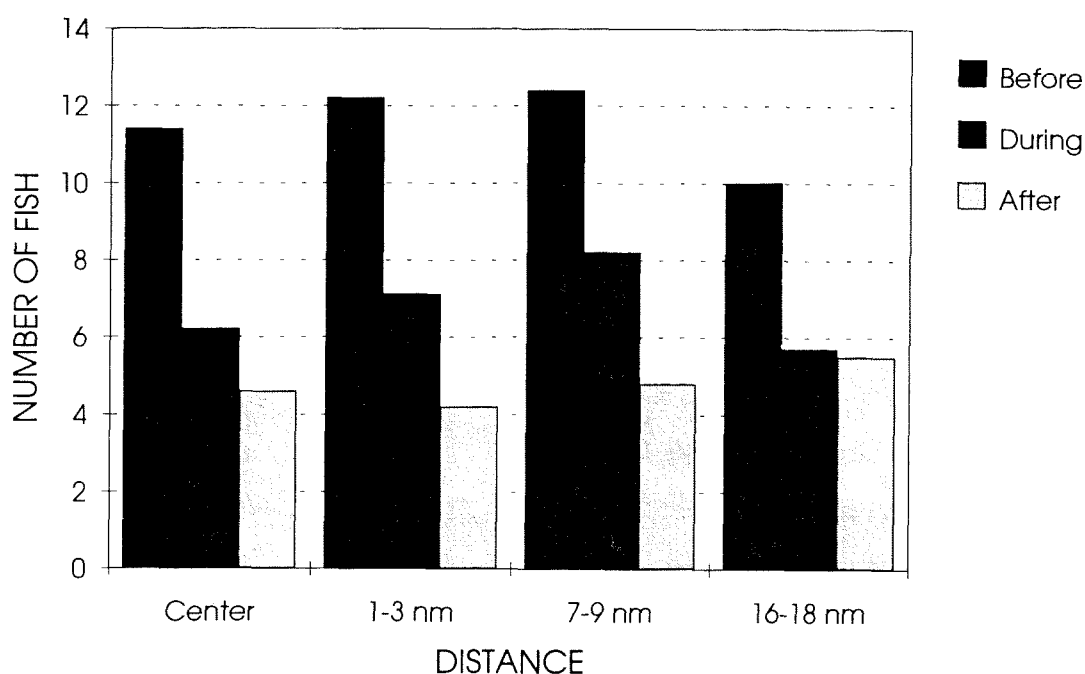

Figure 4.2.17. Average catch of long rough dab before, during and after shooting.

Long rough dab has no commercial significance for Norwegian fisheries, hence there is no immediate interest for studying how this species reacts to seismic shooting. However, long rough dab can be viewed as a representative for flatfish in general, which are distinguished from cod fishes, among other reasons, by lacking a swimbladder.

4.3 Longline catches

Catch size

The fish caught by the longliner "LORAN" were only length-measured, not weighed. The weight was derived from the length measurements by means of the length-weight relationship empirically established on board the trawler "ANNY KRÆMER" (Appendix C, Figs. 1 and 2). The most important species in the catch was cod, but the contribution of haddock was greater in the longline catches than in the trawl catches, especially early in the trial period (about 25% by weight).

Figure 4.3.1 (also Appendix E, Table 5) shows the quantity of cod caught by longlining before, during and after the seismic shooting, subdivided in groups according to distance from the shooting area. Statistical analyses of the catch data from "LORAN" are shown in Appendix F, Tables 3 and 4. In the central trial area the catch of cod declined by 44% when the shooting began, but the reduction was less outside of this area (respectively 16 and 25% at 1-3 and 7-9 nautical miles). At the furthest position (16-18 nautical miles) there was no significant reduction in cod weight. In contrast to the trawl catches, there was a tendency for the longline catches of cod to increase after conclusion of the shooting. At the three most central positions the increase was, on average, 33, 24 and 23%, respectively. The reduction at the furthest position was 23%.

For haddock the catches declined significantly during shooting (Appendix F, Table 4). The reduction was about 50% in the mean over the entire area. There was a reduction in catch out to the edge of the area, but the decrease was greatest in the central area (Fig. 4.3.2 and Appendix E, Table 6). In contrast to the results for cod, there was no sign of an increase in catch after the shooting had ceased.

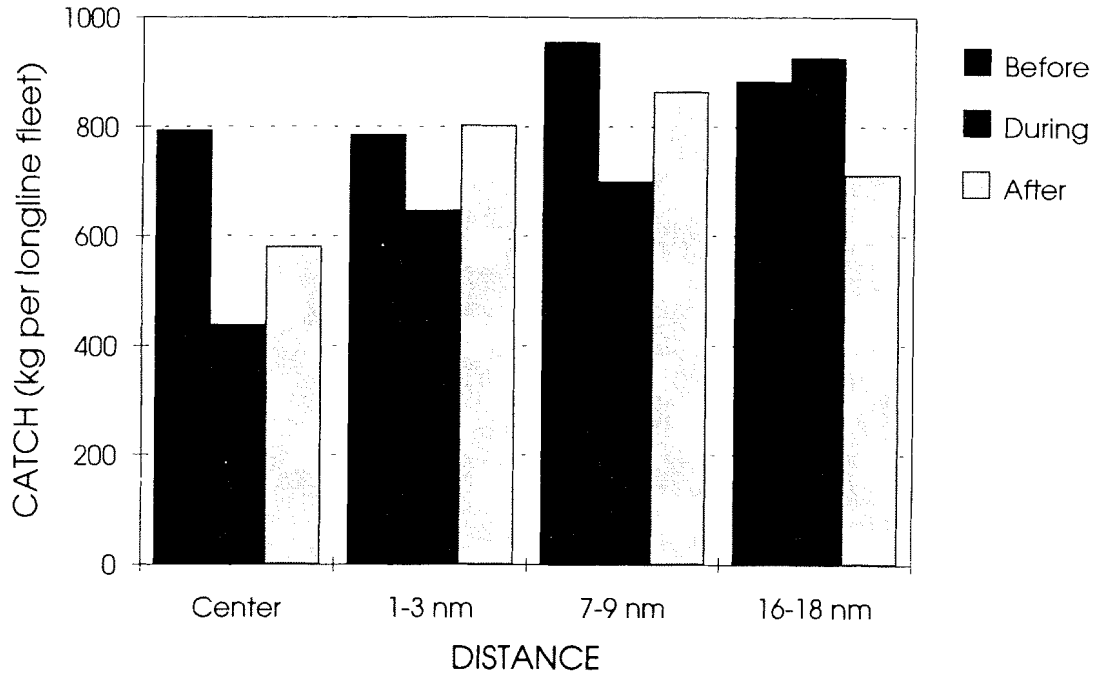

Figure 4.3.1. Average longline-catch rate for cod before, during and after shooting, arranged by distance from the shooting area.

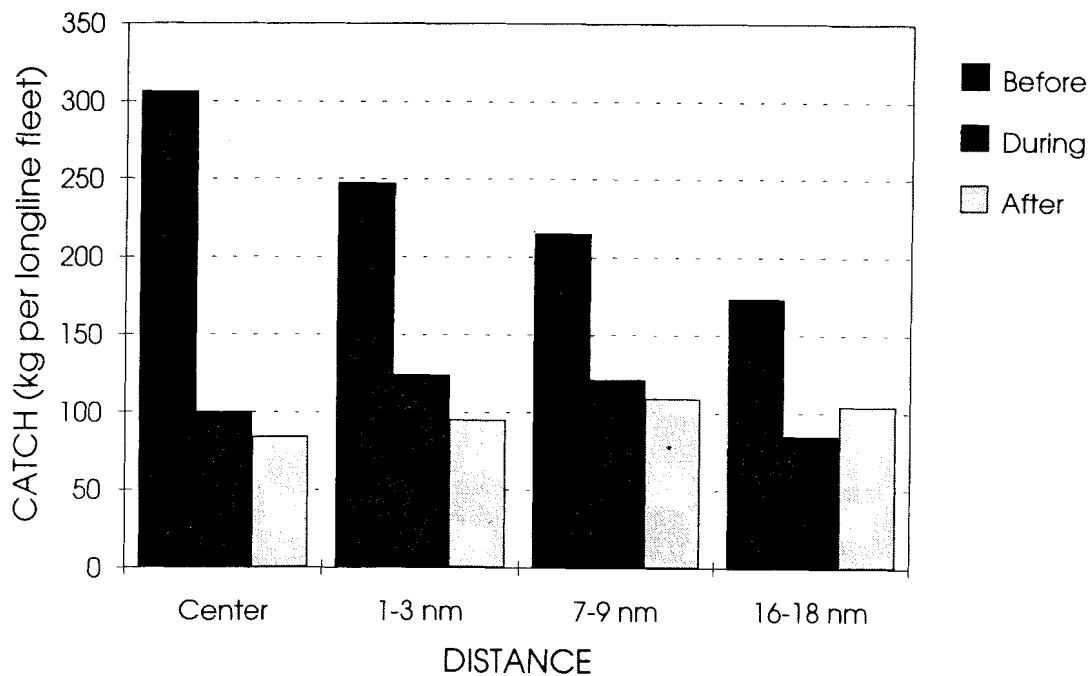

Figure 4.3.2. Average longline-catch rate for haddock by before, during and after shooting, arranged by distance from the shooting area.

Figures 4.3.3 and 4.3.4 show the time series for catches of cod and haddock by longline. The catches are arranged in chronological order according to the time of hauling, and are shown as a deviation from the grand average over the entire trial period.

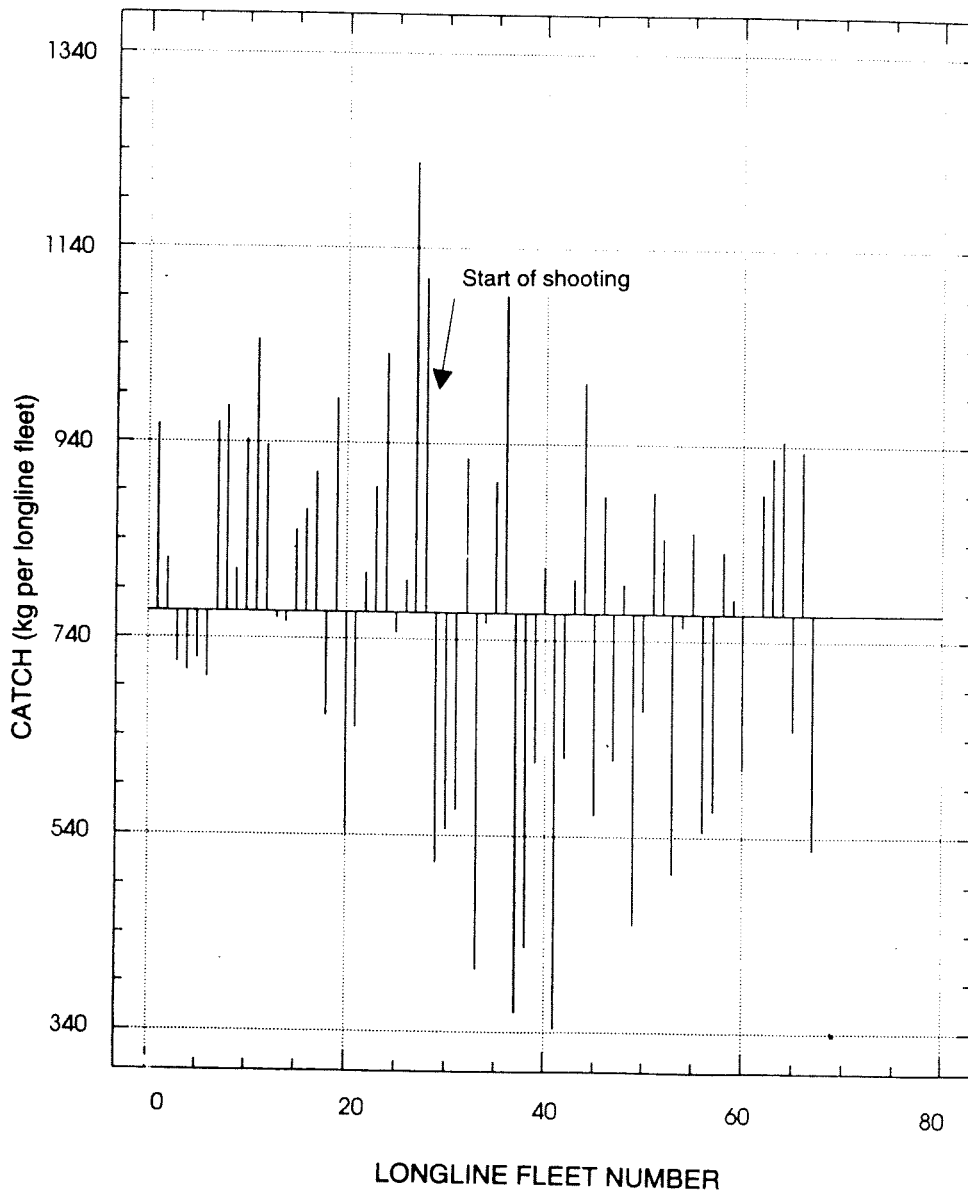

Figure 4.3.3. Longline-catch rates for cod arranged in chronological order. The two longline fleets taken at the same distance each day are regarded as a single unit. The catches are shown relative to the average (horizontal line) for the entire trial period.

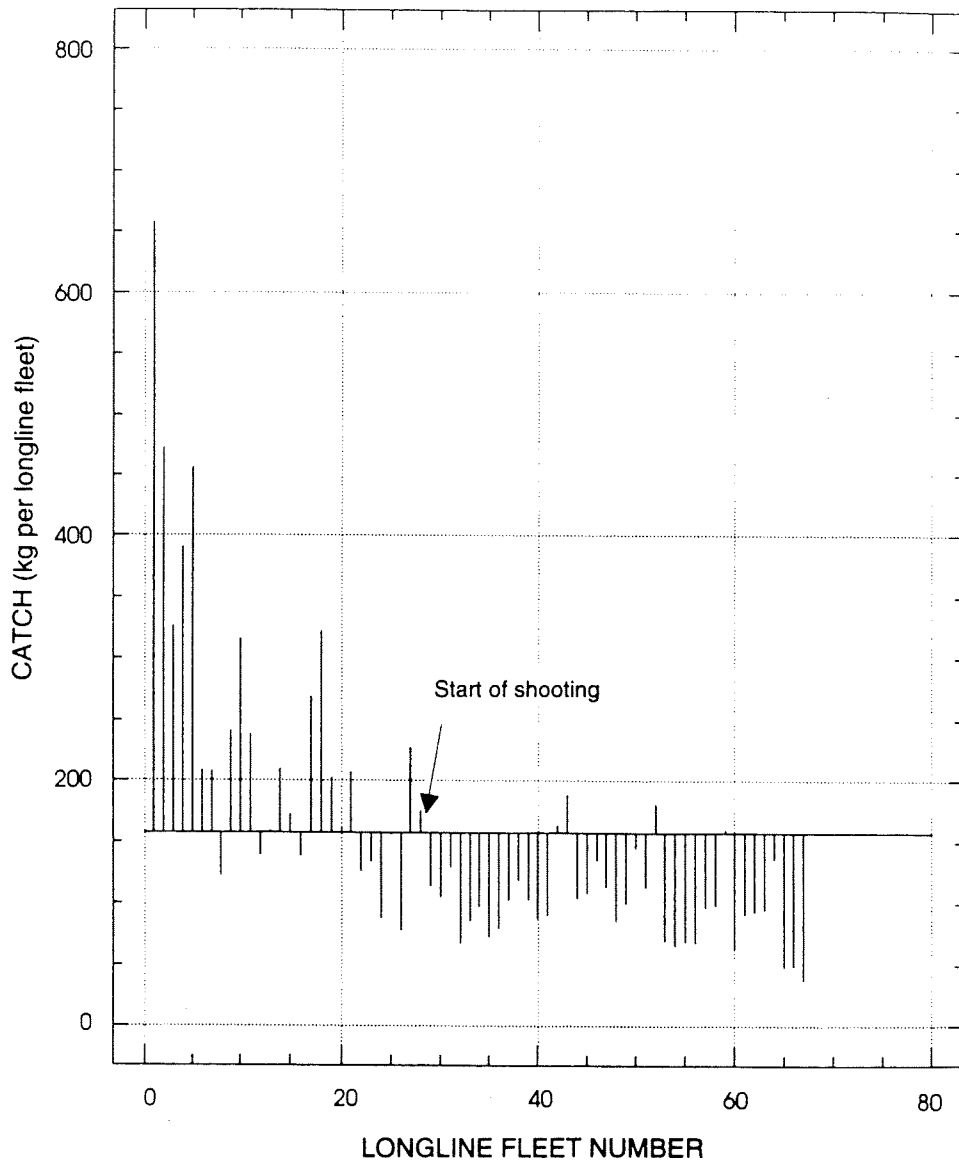

Figure 4.3.4. Longline-catch rates for haddock arranged in chronological order. The two longline fleets taken at the same distance each day are regarded as a single unit. The catches are shown relative to the average (horizontal line) for the entire trial period.

The catches of cod, as with trawl, were distinctly reduced from the moment the seismic shooting began. There was, however, large variation in fish quantity from longline fleet to longline fleet. It must be considered that the longline fleets at all distances from the shooting area are included in the figure and, as earlier mentioned, there was no reduction in catch at the border of the trial area. This will contribute to greater variability than in the corresponding figure for trawl catches.

It might appear that there was a distinctly negative trend in the average catch rates for haddock by longline before the shooting started. However, the variability in catch was quite large in this period. When the shooting began, the variability in catch rates was much less, and the rates stabilized at a low level.

Length distribution and number of fish in the catch

For cod caught by longline there was a corresponding relationship between weight reduction and number reduction as by trawl. While the reduction in weight of cod in the central area was 44%, the reduction in number at the same place was only 26% (Fig. 4.3.5). A corresponding relationship between number reduction and weight reduction was also observed at the other distances. In the longline catches too this was caused by changes in the length distribution of the catches when the shooting began. The reduction in the number of haddock varied between 25 and 50% (Fig. 4.3.6), while the weight reduction was about 50% over the entire area.

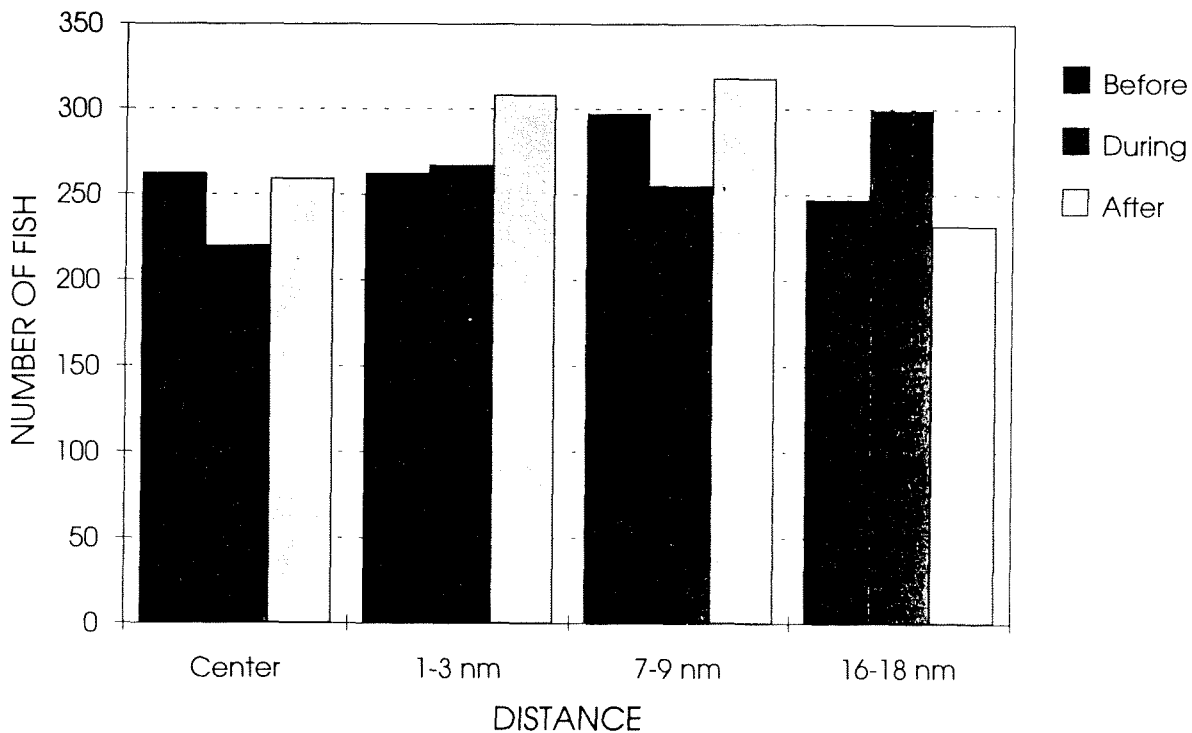

Figure 4.3.5. Average number of cod caught by longline before, during and after shooting, arranged by distance from the shooting area.

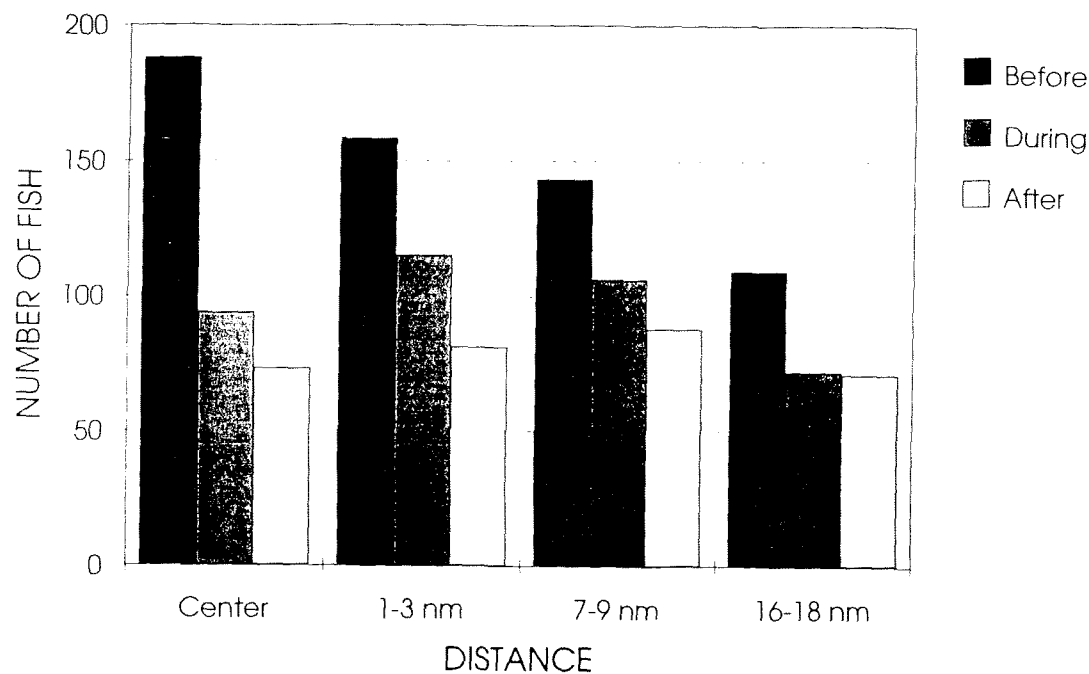

Figure 4.3.6. Average number of haddock caught by longline before, during and after shooting, arranged by distance from the shooting area.

The length distribution for both cod and haddock was also bimodal (two-peaked) in the longline catches (Figs. 4.3.7 and 4.3.8). The length spectrum for cod closely resembled that from trawl, with a peak near 50 cm and another near 80 cm. Haddock had a broader distribution in the longline catches than in the trawl catches, and a more distinct bimodal distribution, with maxima at 40 and 60 cm. When the shooting started, clear changes in length spectra occurred for both cod and haddock. For cod the peak near 80 cm broadened, while that at 60 cm became higher. For haddock a reduction occurred over the entire length spectrum, but the decline was greatest for fish over 50 cm.

Figures 4.3.9 and 4.3.10 show the number of cod and haddock over and under 60 cm in the longline catches before, during and after the shooting (also Appendix E, Tables 7 and 8). The number of large cod within the shooting area was reduced by 57%. There was also a significant reduction in the two regions nearest the shooting area (27 and 34%), while there was no change at the greatest distance. There did appear to be an increase in the catches of large cod after the shooting ended. For cod less than 60 cm there was, however,

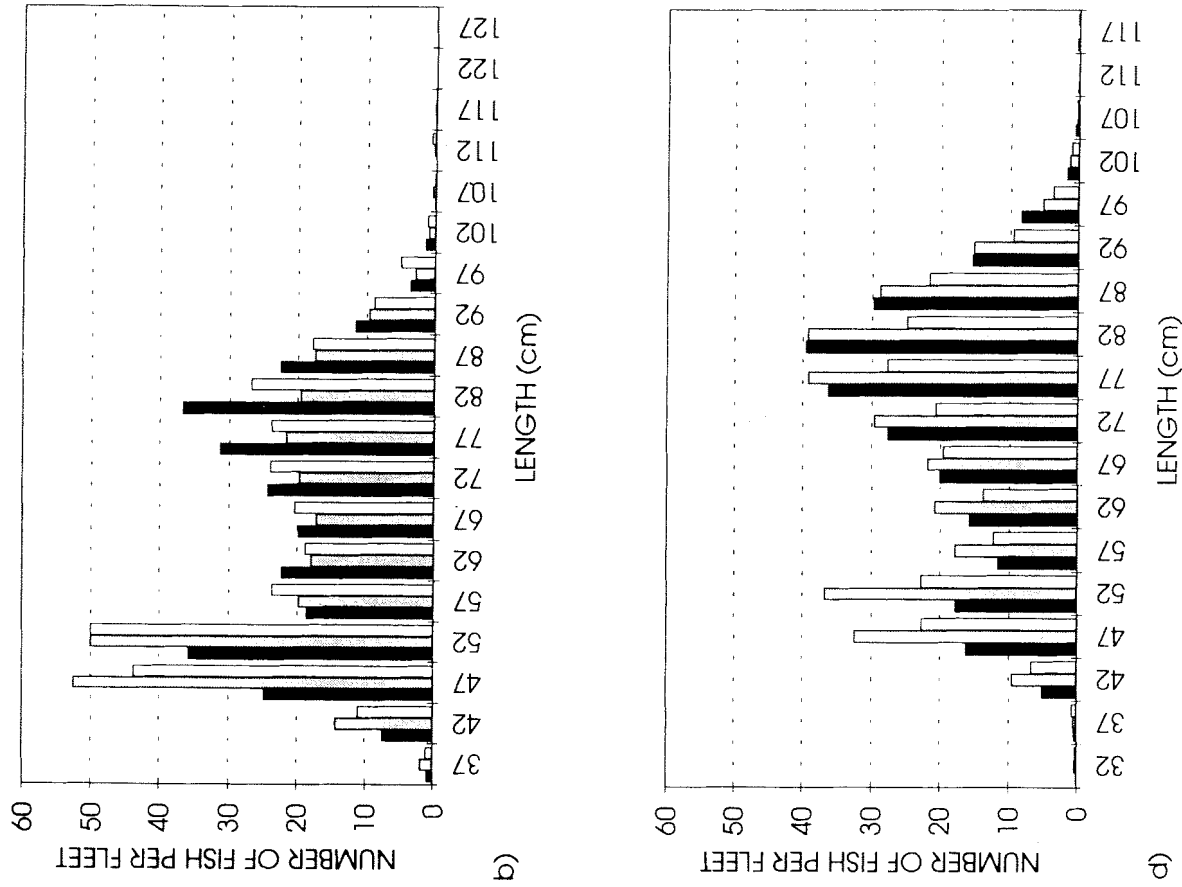
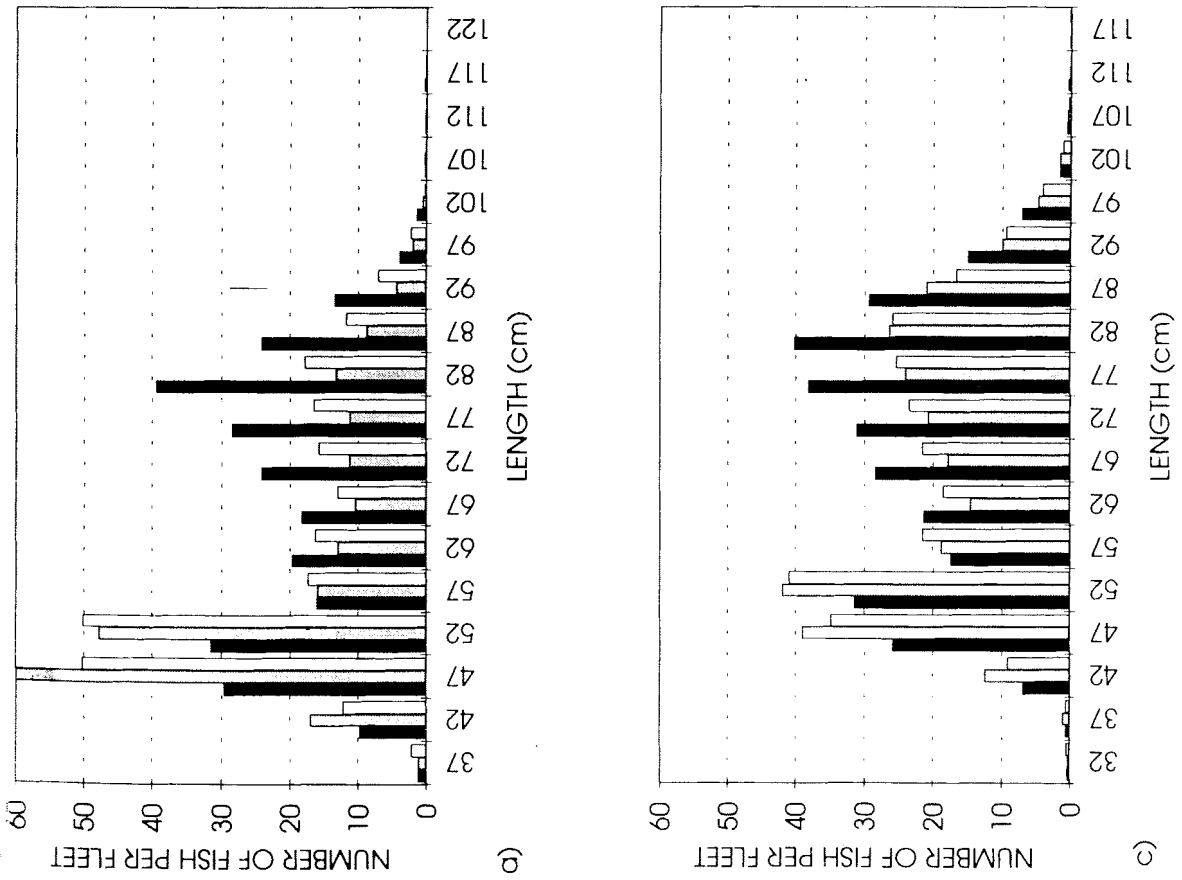

Figure 4.3.7. Length distribution of cod caught by longline before, during and after shooting. (a) within the shooting area, (b) at 1-3 nautical miles, (c) at 7-9 nautical miles, (d) at 16-18 nautical miles.



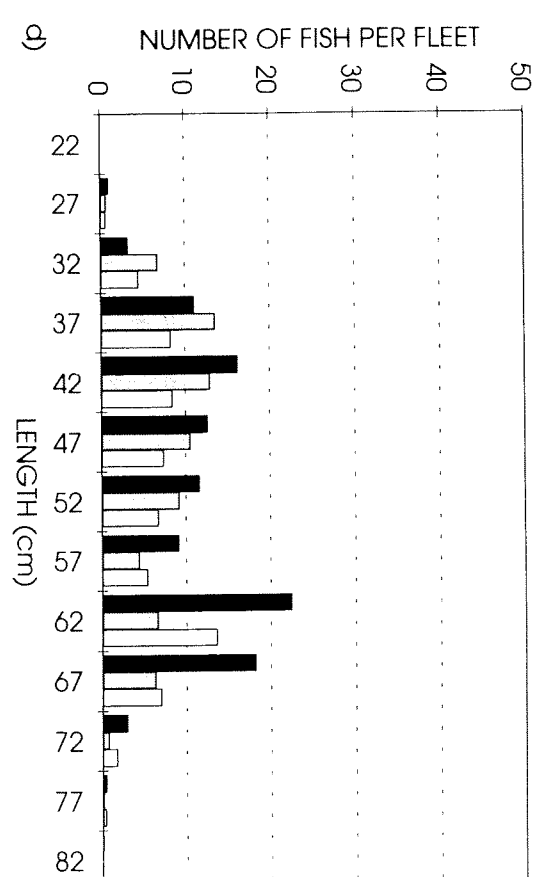
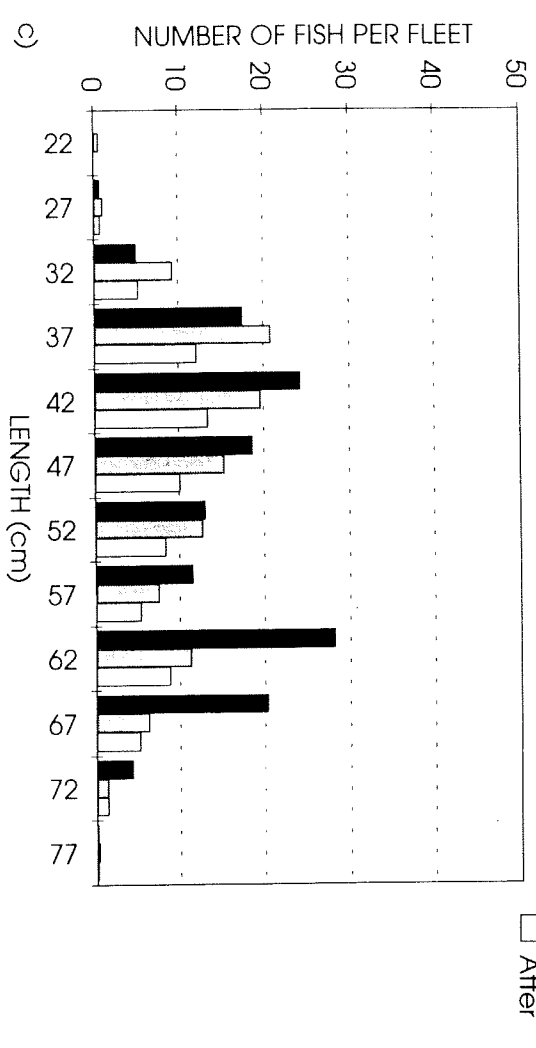
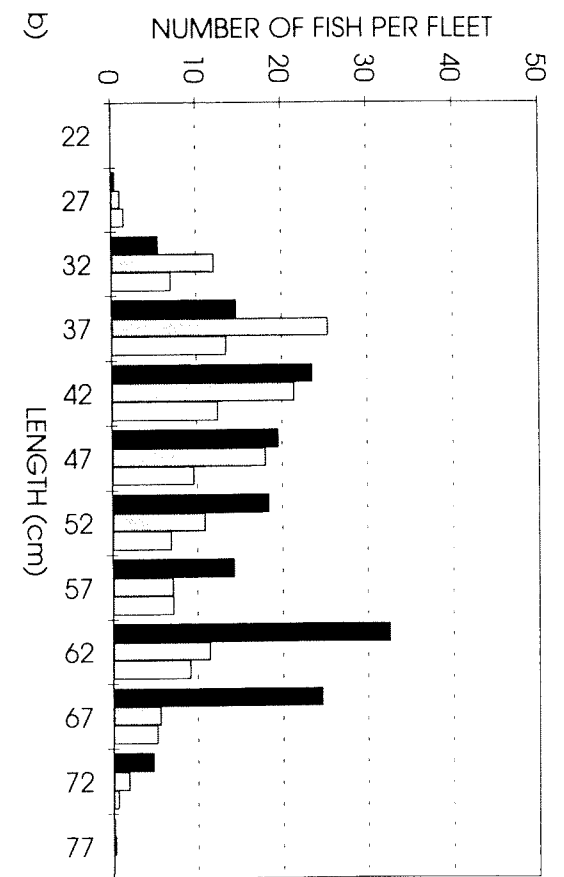
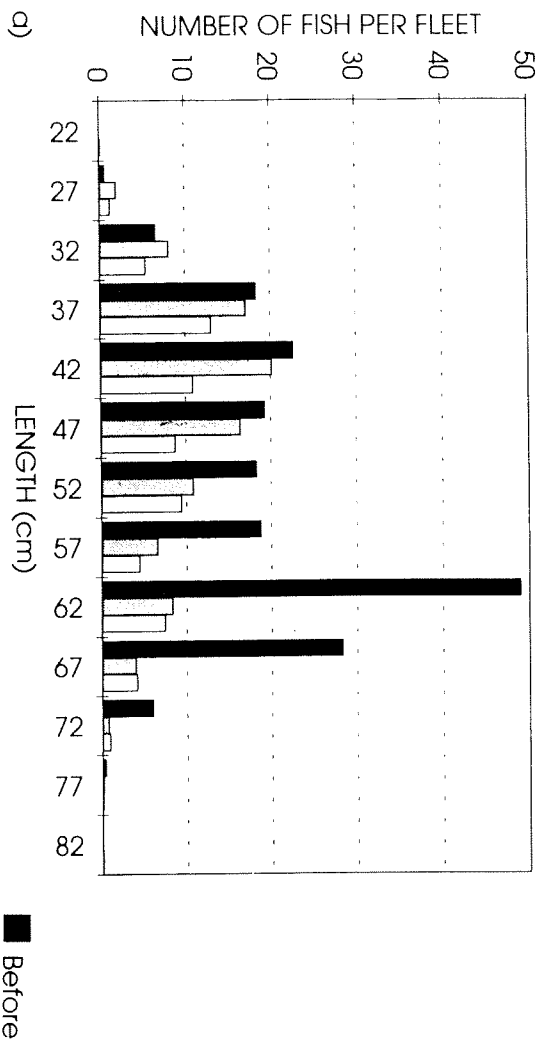
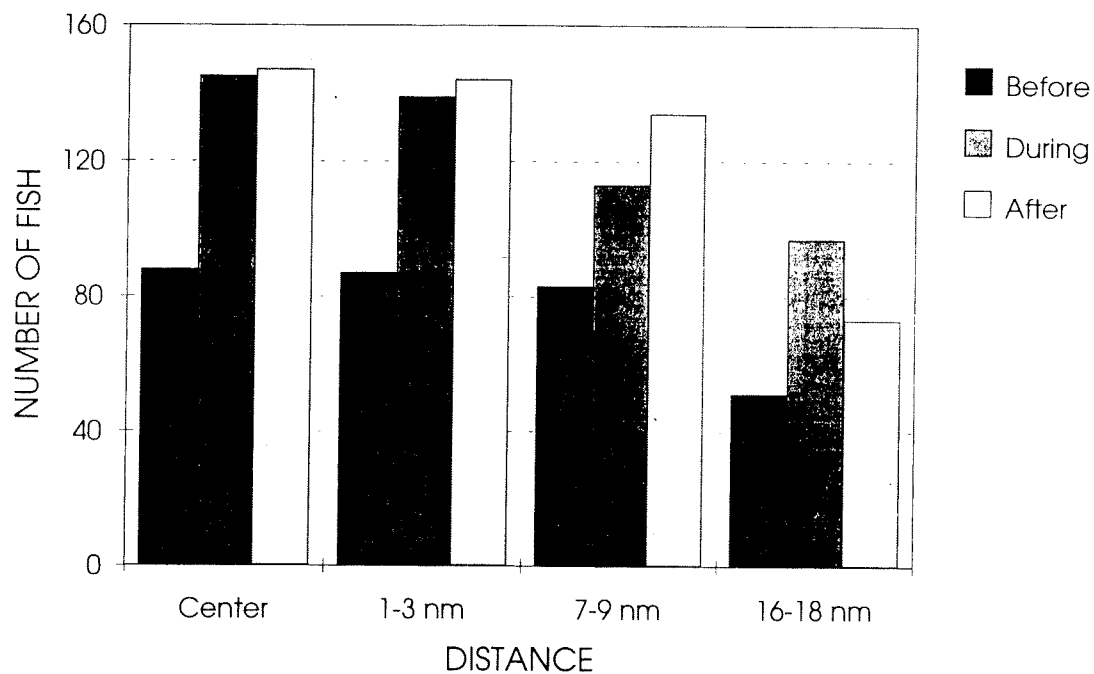
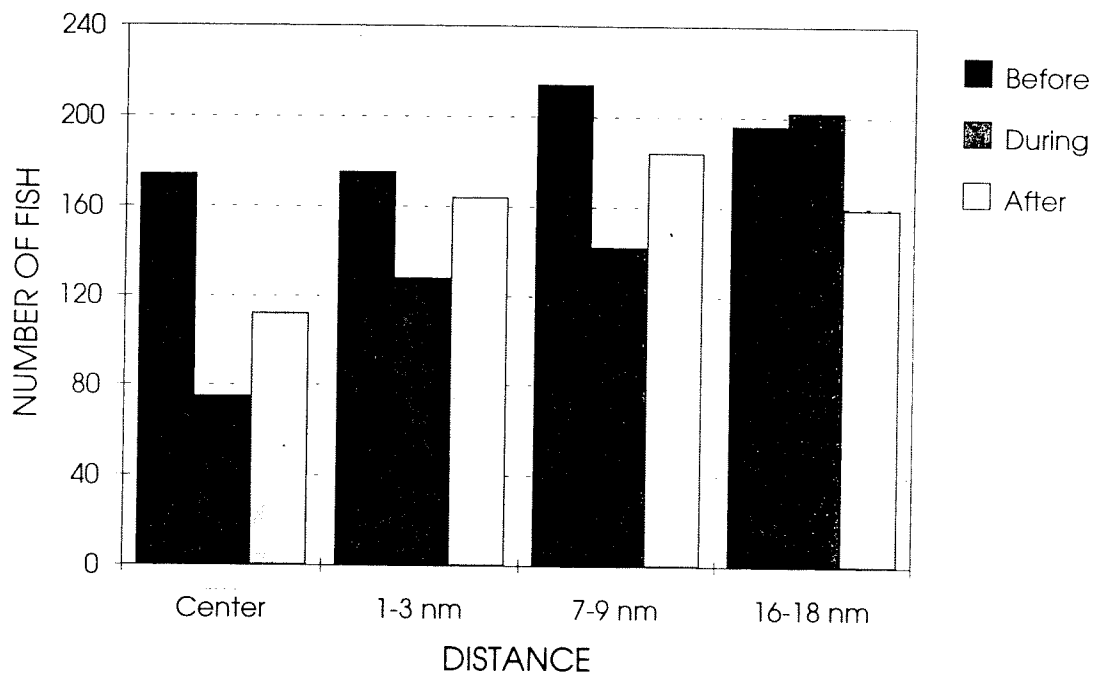

Figure 4.3.8. Length distribution of haddock caught by longline before, during and after shooting. (a) Within the shooting area, (b) at 1-3 nautical miles, (c) at 7-9 nautical miles, (d) at 16-18 nautical miles.



a)



b)

Figure 4.3.9. Number of (a) small (<60 cm) and (b) large (≥ 60 cm) cod caught by longline before, during and after shooting.

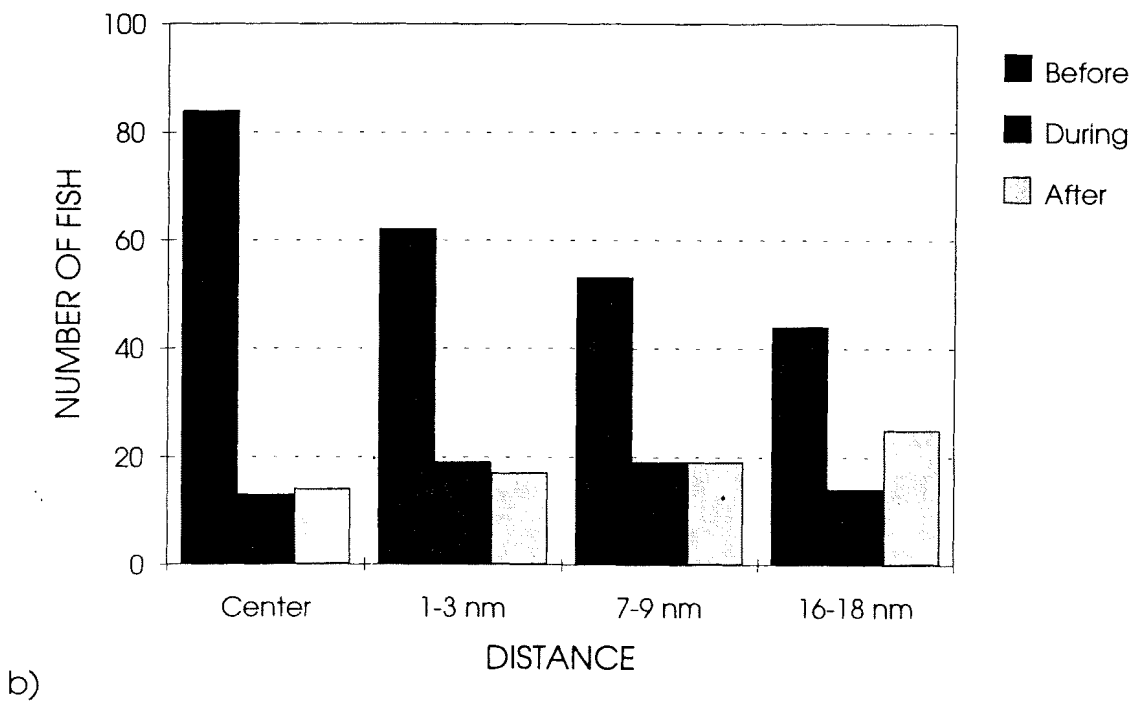
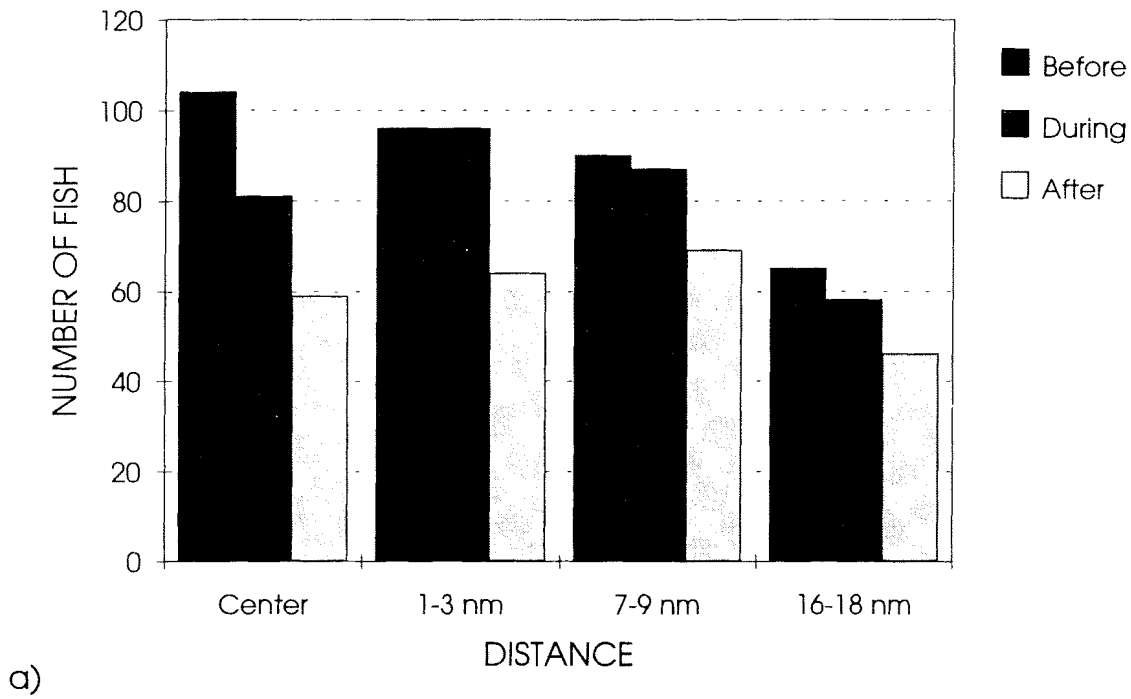

Figure 4.3.10. Number of (a) small (<60 cm) and (b) large (≥ 60 cm) haddock caught by longline before, during and after shooting.

an increase in the number of fish per longline fleet during the shooting, relative to that before the shooting began. This increase was respectively 65, 60, 36 and 90% at the various distances.

For haddock there was a dramatic reduction in the number of large fish during the shooting (Fig. 4.3.10b). The number reduction within the shooting area was 85%, while the reduction at the other distances was respectively 69, 64 and 68% (Appendix E, Table 8). After conclusion of the shooting, the catch rates stabilized at the same level as during the shooting. For smaller fish, differences in catches before and during shooting were small (Fig. 4.3.10a), but the cumulative reductions in number from the period before shooting to the period during shooting were respectively 22, 0, 3 and 11% at the various distances. This decrease continued after conclusion of the shooting, with a reduction from the period during shooting to that after shooting of respectively 27, 33, 21 and 21%.

4.4 Stomach samples

On board the longliner "LORAN" stomach samples from cod and haddock were taken every day. On board the trawler "ANNY KRÆMER" stomach samples were collected daily from cod. In general there was a low content of food in the stomachs of both cod and haddock throughout the entire trial period. Between 91 and 95% of the cod caught by trawl had empty stomachs (Table 4.4.1). In the longline catches between 73 and 79% of the cod stomachs were empty, and 45-54% of the haddock stomachs were empty.

The degree of filling, which is a measure of the quantity of food content on a scale from 1 (empty) to 5 (full), changed little throughout the trial period for both species and with both gears (Table 4.4.2). This was low (1.09-1.17 on average) for cod from the trawl catches. Evidently cod caught by longline had fed more than cod caught by trawl. Here the degree of filling was 1.4-1.5. The cause of this difference was, however, that remains of longline bait (squid and mackerel) were in the cod stomachs. If stomach samples containing remains of

Table 4.4.1. Number and proportion as a percentage (in parentheses) of cod and haddock, with and without stomach contents, from the trawl and longline catches.

	Cod						Haddock		
	Longline			Trawl			Longline		
	Before	During	After	Before	During	After	Before	During	After
Empty	61 (74.4)	67 (73.6)	60 (78.9)	82 (93.2)	134 (95.0)	84 (91.3)	26 (45.6)	43 (53.8)	30 (50.0)
With content	21 (25.6)	24 (26.4)	16 (21.1)	6 (6.8)	7 (5.0)	8 (8.7)	31 (54.4)	37 (46.2)	30 (50.0)
With bait remains	16 (19.5)	14 (15.4)	9 (11.8)	-	-	-	4 (7.0)	4 (5.0)	4 (6.7)

Table 4.4.2. Average degree of filling (\pm standard error) in stomach samples from cod and haddock. Range of degrees of filling: 1=empty stomach, 5=full stomach.

	Cod			Haddock		
	Longline		Trawl	Longline		
	Total	Total excluding bait remains		Total	Total excluding bait remains	
Before	1.51 \pm 0.11	1.11 \pm 0.06	1.13 \pm 0.06	1.74 \pm 0.12	1.53 \pm 0.08	
During	1.51 \pm 0.11	1.24 \pm 0.08	1.09 \pm 0.04	1.68 \pm 0.10	1.54 \pm 0.08	
After	1.42 \pm 0.10	1.18 \pm 0.07	1.17 \pm 0.07	1.80 \pm 0.13	1.63 \pm 0.12	

bait are excluded, then there is no significant difference in degree of filling for cod caught by longline or by trawl. The degree of filling for haddock caught by longline was somewhat higher than that for cod; from 1.53 to 1.63 if bait remains are ignored.

4.5 Radiated noise measurements

Sound measurements of the seismic shots were made by hydrophones at 80 m depth. Figure 4.5.1 shows the waveform of a shot measured at 165 m distance from the source. The peak value was computed to be 248.7 dB re 1 μ Pa at 1 m, which is the highest value among those recorded. Inasmuch as the measurement point was roughly 65 deg from the acoustic axis, the level was somewhat higher than expected from the specified on-axis sound level of the air gun array, namely 250 dB re 1 μ Pa at 1 m (Fig. 4.5.2). In addition, a variation in peak value from shot to shot of about 3 dB was observed.

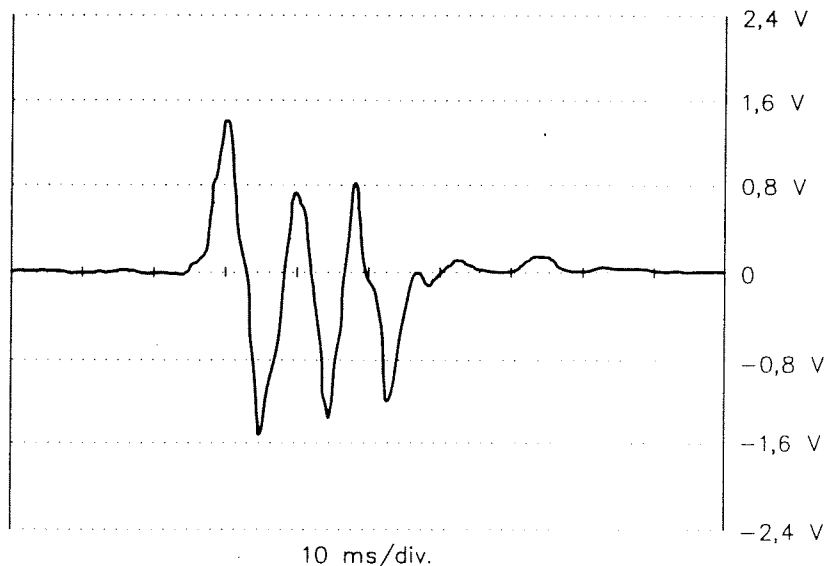

Figure 4.5.1. Measured waveform for a single shot from the air gun array on "ACADEMIC SHATSKIY".

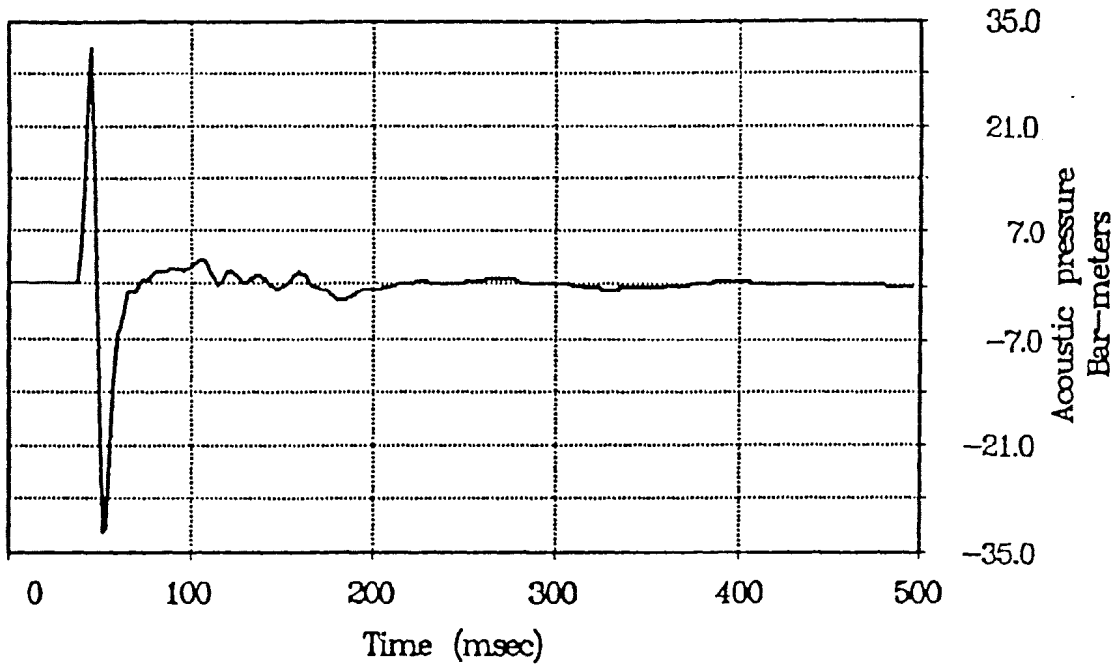

Figure 4.5.2. Waveform from the air gun array as specified by Geco-Prakla.

The measured waveform deviated in part from the specified form, which most likely is a result of interference between the direct and surface-reflected sounds. With respect to frequency there was a good correspondence between measured and specified sound spectra (Figs. 4.5.3 and 4.5.4). The main part of the energy in the waveform was confined to the band 10-150 Hz.

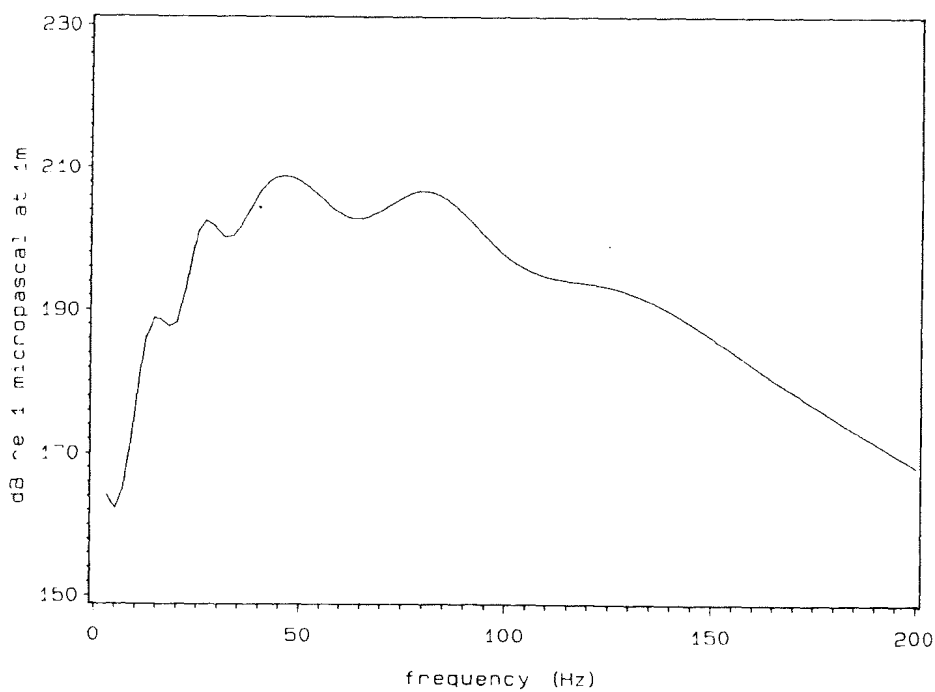

Figure 4.5.3. Measured frequency spectrum from the air gun array on "ACADEMIC SHATSKIY".

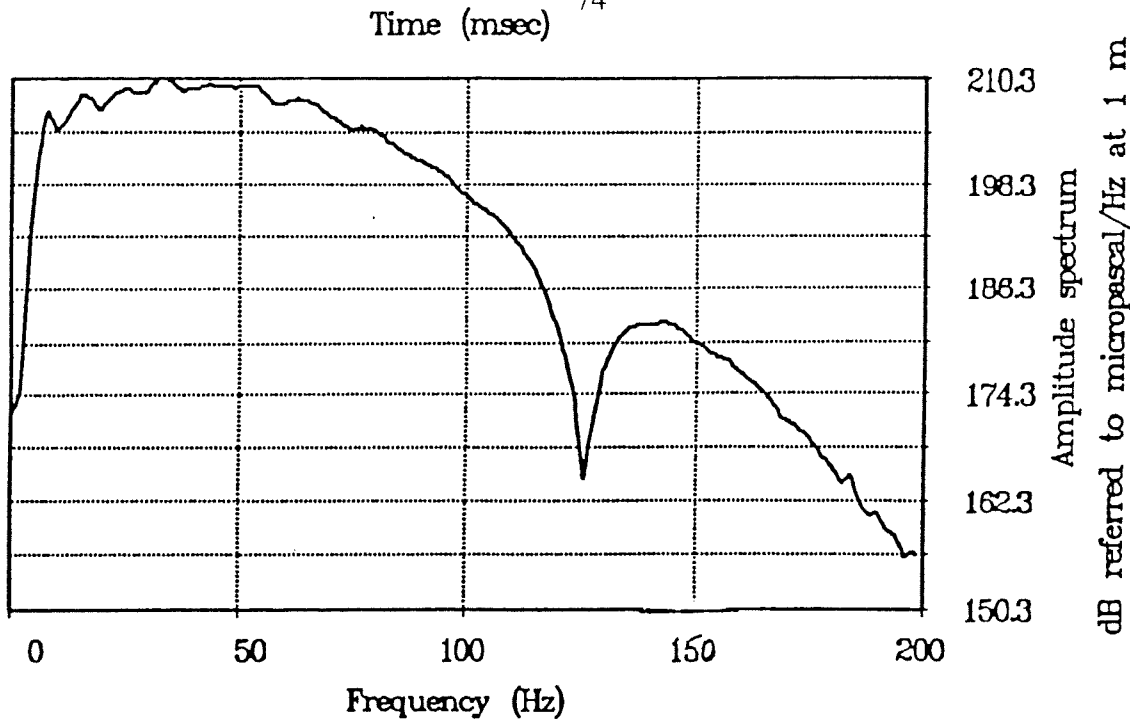

Figure 4.5.4. Frequency spectrum from the air gun array as specified by Geco-Prakla.

The spectral level of the sound from the air guns was about 120 dB over the ambient noise level (Fig. 4.5.5) and about 60 dB over the noise level from "STALLO" and "ANNY KRÆMER" when trawling. Figures 4.5.6 and 4.5.7 show the noise spectra from all of the vessels at trawling or working speeds and when cruising, respectively.

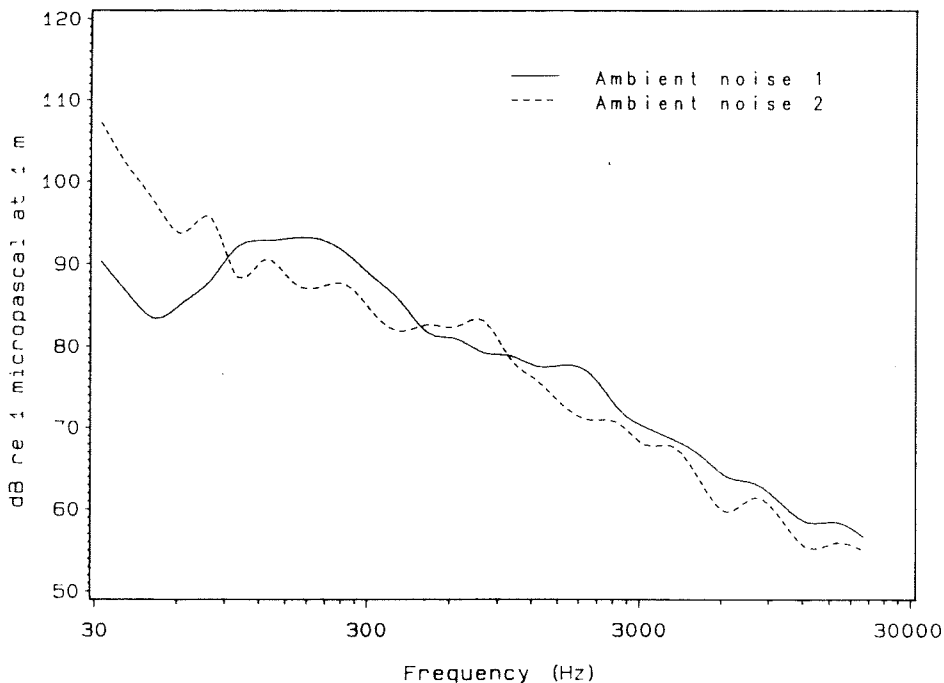

Figure 4.5.5. Ambient noise level on North Cape Bank (1) and in Sørøy Sound (2) during acoustic measurement of the air gun array and vessels.

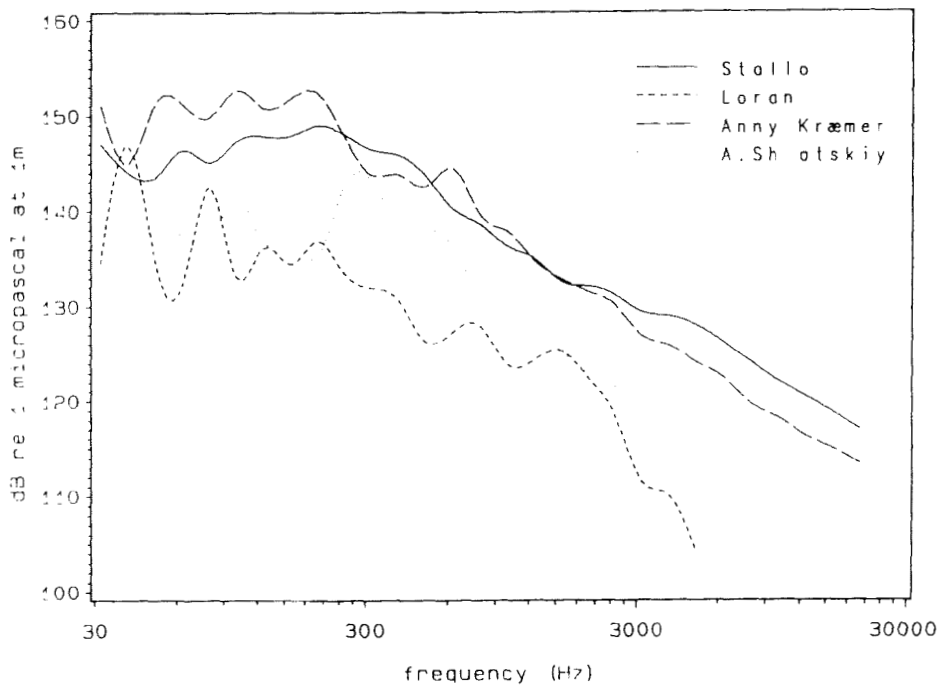

Figure 4.5.6. Frequency spectra during working conditions for the vessels that participated in the trial. "ANNY KRÆMER" and "STALLO" were measured during trawling. "LORAN" was measured during heaving of the longline. "ACADEMIC SHATSKIY" was measured at the speed that is used during shooting with the air gun array.

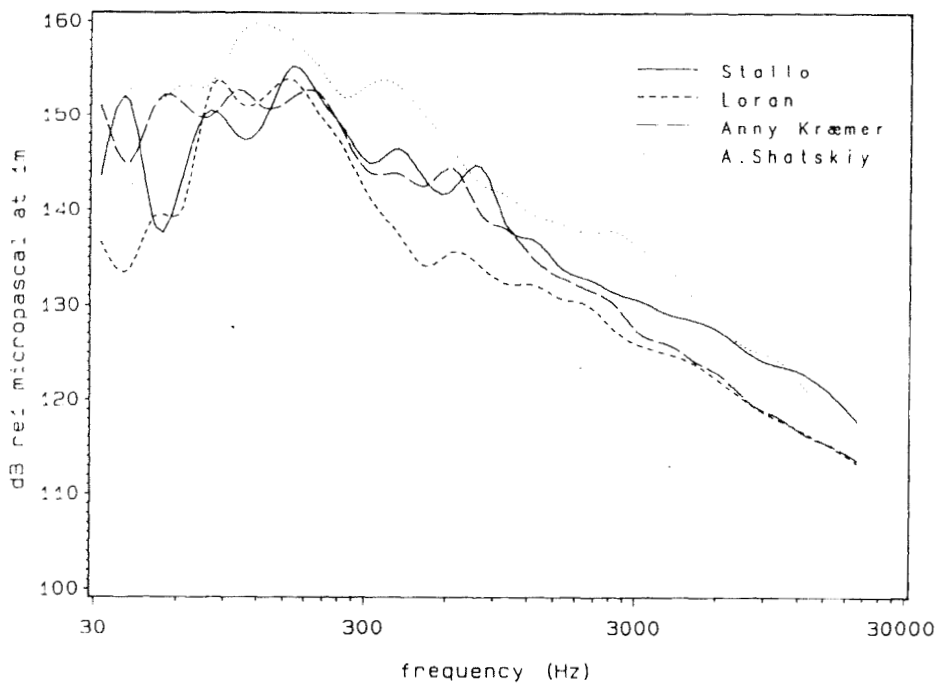

Figure 4.5.7. Frequency spectra of all vessels that participated in the trial, measured under free-sailing conditions.

With respect to noise, "STALLO" and "ANNY KRÆMER" were similar both when trawling and cruising, with a maximum level under cruising of about 153-155 dB re 1 μ Pa/Hz at 1 m in the frequency band 60-200 Hz. "ACADEMIC SHATSKIY" had a maximum level of 160 dB re 1 μ Pa/Hz at 1 m over the band 90-200 Hz when cruising, but was much lower under operation. When cruising the noise level of "LORAN" resembled that of the trawlers, while the noise level was at least 10 dB less when working.

4.6 Current measurements and STD-measurements

The current speed at 10 m over the bottom was on average 12 cm/s, principally in a northerly direction (Appendix G, Figs. 1 and 2). Although a diurnal variation was demonstrated, which is assumed to be tidal, no systematic differences between the various periods were demonstrated which could have influenced the longline results.

Typical temperature, salinity and sound speed profiles in the survey area are shown in Appendix G, Figure 3. The sound speed varied from 1467 to 1471 m/s, and it is on this basis that approximately linear, direct sound paths are expected in the survey area.

5. DISCUSSION

5.1 Does seismic shooting affect catch and catch-availability of cod and haddock?

Effect on catch rates

The acoustic mapping and catch trials with trawl and longline on North Cape Bank showed that seismic shooting with air guns affects the fish distribution and catch rates for cod and haddock, not merely locally within the region where shooting occurs, but also significantly in surrounding areas.

The trawl-catch rates for both cod and haddock was halved within the total survey area of 40 x 40 nautical miles when the shooting commenced. The reduction was greatest in the center, that is, in the seismic shooting area, where the reduction was as much as 70% compared to the rate before the shooting began. The reduction in trawl catches was in general agreement with the acoustic observations, which indicated a reduction of 45% in the total quantity of cod and haddock within the survey area. Similarly, the reduction in acoustic values was greatest in the central region.

The reduction in longline-catch rates for cod were not as great as those for trawling. The reduction was 44% in the seismic shooting area, but the influence on catch rates gradually diminished towards the border of the survey area. For the longline fleets that were set furthest from the shooting area (16-18 nautical miles), no decrease in catch rates for cod was observed. For haddock, a reduction in weight per fleet of roughly 50% was demonstrated over the entire survey area.

The catching principles for trawl and longline are quite different. A trawl is an active gear which in principle catches all fish over a given size that come between the trawl doors within

the height of the trawl, if avoidance and sweep effects are ignored. In the present case, the distance between the trawl doors is 150 m and the trawl height is 4.2 m. Longline is a passive gear which is based on the principle of active search by the fish. Fish sense odors from longline bait over a large area, dependent on dissolution of the odor-bearing substances, water velocity, etc., and move towards the gear if wanting to feed. Longline can be saturated with respect to the catch quantity, because it cannot catch more fish when all of the hooks are occupied or the bait has been consumed (Skud 1978). This indicates that longline does not necessarily give a true picture of the total quantity of fish in an area.

Two possible reasons may be given for the reduction in trawl-catch of cod at the border of the survey area, which was not observed by the longline. Firstly, a density gradient was observed from the center towards the border of the survey area during shooting. Although the quantity of cod was reduced in the border region, it is possible that the number of fish remaining in the vicinity was sufficient to maintain the longline catch, in other words, that longlining does not give a true picture of the total quantity in the region. Secondly, there may be differences in fish reaction to noise from the seismic shooting, dependent on the distance from the source of sound. The difference in sound level between the center and 16-18 nautical miles is large, and the sound will clearly be more unpleasant and frightening to fish near the source of sound. It may be assumed that the behavior pattern of fish, including grazing behavior, is affected more near the shooting area than further away. This can result in a smaller proportion of the fish seeking longline in the central trial area.

The reduction in catch rates that was observed for cod and haddock on North Cape Bank largely agrees with that found in other investigations. Løkkeborg and Soldal (1993) found a 50-80% reduction in the catch of cod on longline fleets placed within a seismic shooting area off the Finnmark coast. Also observed was a reduction of about 80% in the secondary catch of cod in the shrimp fishery within and near to (up to 5 nautical miles distance) the seismic shooting area east of Bear Island and off the coast of east Finnmark. Løkkeborg and Soldal (1993) also observed, however, an increase in the secondary catch of cod in the commercial saithe fishery on Storegga during two brief periods of seismic shooting (3 and 9 hours). This increase is explained by a "plowing" effect, which will be discussed in more

detail below under the heading "Effect on fish behavior pattern". Skalski et al. (1992) observed a 50% reduction in longline catches of various redfish species off the California coast during operation of a single air gun.

Effect on large and small fish

By splitting the catch into two size groups (larger and smaller than 60 cm or about 2 kg), it was evident that large fish disappeared from trawl and longline catches in a larger degree than did small fish. However, while the number of small cod was reduced in the trawl catch, the number increased in the longline catch. The acoustic investigations also showed that both size groups were reduced, but that the relatively greater reduction occurred for fish larger than 60 cm. A similar relative reduction was observed for haddock, both from trawl and longline catches and from the acoustic estimates, although a reduction in both size groups was not demonstrated.

The reason that the number of small cod in the longline catch increased somewhat, rather than decreased as in the trawl catch and acoustic estimates, may lie hidden in the catch capacity of the several gears and catching method. While the trawl and acoustic data give a more direct measure of stock size, fish behavior plays a major role in catching by longline. What is caught by longline can, among other things, be the result of competition among different species and size groups. As already mentioned, it was especially the large fish that disappeared when the shooting began. This suggests that the smaller fish had less competition in the fight for food, in this case in the form of longline bait, and there could thus be an increase in the number of small fish caught by longline even if the total number of fish in the area was somewhat reduced.

A question can also be raised as to why a larger proportion of large than small fish disappeared? One theory is that larger fish perceive sound from air guns as more unpleasant than do smaller fish, for example, because of the effect of swimbladder resonance. If the air-filled swimbladder vibrates in strong resonance, this must be considered as unpleasant for

the fish. The resonance frequency depends on the swimbladder size, thence the fish size. The larger the fish is, the lower the resonance frequency. However, the resonance frequency for a pressure-compensated cod that is 1 m long is about 600 Hz (Hawkins 1977; Løvik & Hovem 1979). The main part of the energy in the air gun spectrum is under 150 Hz. At such high frequencies as 600 Hz and above, the energy is significantly less. There should therefore be little reason to assume that resonance phenomena can cause differences in the behavior pattern of large and small fish.

Another explanation is that the differences are due to size-dependent differences in swimming capacity of fish. Larger fish clearly have a greater ability to flee from the sound source. In case fish react to shots from the air gun array with calm avoidance, it may be assumed that they swim away at the so-called cruising speed. For a 30-cm-long cod this implies a swimming speed of 0.6 m/s, while a 70-cm fish will swim at 1 m/s (Wardle 1977). At such speeds the cod can swim without exhaustion. If the fish reacts with panic, it can increase its speed, but only over a short time period. If it is assumed that fish within the shooting area when the shooting began swam out of the area at cruising speed, then a 30-cm fish would have been able to swim 52 km or 28 nautical miles in the course of a single 24-hour day, and a 70-cm fish, 86 km or 47 nautical miles. Both would have been able to reach the outer edge of the trial area in under one day without panic-swimming. It is thus unlikely that mere swimming capacity prevents fish smaller than 60 cm from avoiding the sound to the same degree as larger fish do. Accordingly, it must be concluded that the present theories do not account for differences in response among large and small fish.

Effect on fish behavior pattern

It has earlier been asserted (Dalen & Raknes 1985) that bottom fish such as cod and haddock react to noise by seeking the bottom, where it remains inactive as long as it is frightened. This ought to render the fish more available to bottom trawling, which actively catches fish that are on the bottom or within 4 m of the bottom. Longline catches should thus be reduced, because this type of fishing is based on the fish actively seeking food.

The trials on North Cape Bank do not support this hypothesis. The acoustic mapping demonstrated that the fish quantity both in the pelagic and bottom-near parts of the water column were reduced. If the fish was frightened to so near the bottom that it could not be acoustically detected (acoustic "dead zone"), then the relative proportion of measured acoustic density in the bottom channel and catch rates for bottom trawl should have changed during the shooting. This was not the case. The correlation between bottom-trawl catches and acoustically measured fish density in the bottom channel was quite high ($r=0.84$), and the relationship between catch and acoustics was similar in all three periods ($p=0.534$).

Within the shooting area the catch rates sank immediately after the onset of shooting. At 1-3 nautical miles from the shooting area the catch rates in the first two hauls that were taken after the shooting began were at least as large as those taken before the shooting. Most likely this is explained by a "plowing" effect around the seismic vessel. Fish react to sound by a diagonal movement downwards and away from the sound source. While the fish are moving it is possible that they bunch around the sound source. This effect will be brief and disappear as soon as the fish has had enough time to swim away from the area. Such a diving response to sound stimuli is described both in small-scale trials (Engås et al. 1991) and through studies of fish reaction to vessel noise in field conditions (Olsen et al. 1983; Ona 1988; Ona & Godø 1990). An increase in the secondary catch of cod under trawling of saithe on Storegga after brief seismic shooting has been explained according to such a reaction pattern (Løkkeborg & Soldal 1993).

In case the fish remained inactive on the bottom after having been frightened by a sound source, the stomach contents should decrease in course of the trial period, because the fish will no longer actively seek nourishment. Stomach samples from fish on North Cape Bank during the trial gave no support to this hypothesis. There was generally a low content of food in the stomachs through the whole trial period, and no changes were observed in the degree of stomach filling or in the proportion of stomachs with contents while the trials lasted.

Effects of catching effort

There may be reason to question whether the large effort with the gear within the trial area can explain the observed reduction in catches. The relatively largest effort (number of trawl hauls and longline fleets per unit area) was made within the shooting area. Before the shooting commenced, 13 trawl hauls and 14 longline fleets were taken within this area. For the trawls, about 7 tons of cod and 0.5 tons of haddock were captured, and for long line, about 13 tons of cod and 4 tons of haddock. According to the calculated sweep area for the trawl, 5.7% of the area in the inner region was covered, that is, about 6% of the fish near the bottom (up to 4.2 m height) was caught, in case all fish between the doors was caught. For longline it is difficult to compute an effective sweeping area. The acoustic estimates show however that there was about 110 tons of large cod (>60 cm) near the bottom within the central area before the shooting began. In the trawl and longline catches there was about 13 tons of fish over 60 cm. This indicates that the maximum exploitation of fish near the bottom was about 10%. In total, there was about 710 tons of fish within the central region. The total catch was about 20 tons, or less than 3% of the total available.

Based on the catching effort, a weak reduction in the catches could be expected with time, something that is particularly suggested by the data set on haddock. However, the catching trials demonstrate that the seismic shooting caused a reduction in catch that far exceeded that which the actual catch could cause. In case the reduction should be exclusively attributed to catching, then there should also be expected a continued decrease in the catches after the seismic shooting had ended. According to both the acoustic abundance estimates and trawl catches of cod, there was a flattening of the level after the shooting. The longline catches showed a tendency towards an increase. The haddock catches, however, showed a continued weak decrease for both gears, which can suggest a distinct fishery effect.

A reduction in the stock because of catching should also produce an even, gradual decrease in catches throughout the trial period. A large and rapid reduction in the catches immediately after the seismic shooting began cannot be explained as a fishery effect. All such trials will inevitably be subject to lesser errors due to the effect of the experimental design. With such

an initially large stock, here estimated to be about 33,000 tons of fish, a total exploitation of about 100 tons must have had a minimal effect on the result.

5.2 Distance effect

Expected reaction distance

One of the initially formulated problems that was to be addressed by the trial on North Cape Bank was determining how far from the shooting area a possible effect on catch could be proven. The size of the trial area (40 x 40 nautical miles) was chosen based on an expectation of how far away fish would react to a sound level corresponding to that of an air gun array and on experiences from earlier investigations.

On the basis of a sound pressure level of 210 dB re 1 μ Pa/Hz at 1 m in spectral level and a transmission loss of $20 \log R$, the sound level 18 nautical miles from the air gun array would be about 120 dB re 1 μ Pa/Hz. According to Chapter 2, fish should be able to perceive this sound level, and it was expected that there would be a reaction out to about 5.4 nautical miles (10 km).

The acoustic observations and trawl catches demonstrated, however, that the fish were affected over a larger area than expected from the assumed source level and reaction distance. The trawl catches showed a significant reduction over the entire trial area, even 18 nautical miles from the shooting area. Longlining showed a significant decline in haddock catches, but not in cod catches, at the most distant longline fleet (16-18 nautical miles from the shooting area). At the other positions there was a demonstrable reduction in catches of both cod and haddock.

As earlier mentioned, changes in behavior were demonstrated with a total sound level of 150-167 dB re 1 μ Pa among redfish species (*Sebastes* sp.), when subjected to noise from a single air gun (Pearson et al. 1992). This corresponds approximately to a spectral level of 110-130 dB re 1 μ Pa, or the sound level computed for the edge of the investigation area. This can suggest that the assumed difference between detection and reaction levels for air gun noise is less than expected.

Effect of vessel noise

Throughout the trial period there was considerable traffic due to vessels in the trial area, especially in the shooting area. It may be wondered whether vessel noise may have contributed to the frightening of fish out of the region. As earlier mentioned, it has been demonstrated that fish react by avoidance when sound from propeller and machinery exceeds a given level (see, for example, Olsen et al. 1983; Ona 1988; Engås et al. 1991; Ona & Godø 1990). That vessel noise could have produced local avoidance cannot be denied, but there are many factors which show that this can hardly explain the observed reduction in fish density and catch rates.

There was intense fishing within the central area in the days before and during the seismic shooting. A reduction in the stock and catch as a consequence of vessel avoidance could be demonstrated by an even, moderate decrease. However, an abrupt and significant reduction in catch was observed immediately with the onset of shooting by the seismic vessel. The fishing vessels and the acoustic survey vessel crisscrossed the entire trial area in transects from border to border. For fish on the bottom the influence of noise relative to the vessels will be independent of direction. Vessel noise could hardly cause a net migration out of the area, but rather brief local movements in random directions around the vessels. That reactions to vessel noise are local in extent, with a duration of 8-10 minutes, has also been experimentally demonstrated (Ona 1988; Ona & Godø 1990; among others).

At the edge of the area the degree of coverage with both acoustics and catching trials was much lower than in the center. Here the influence of the vessels was so small that an effect on the stock is most unlikely. Nonetheless, a reduction both in trawl catches and acoustically measured fish density was observed. An important point is that for fish near the bottom the sound level from the air gun array is higher than that from the vessels over the entire trial area, even at 18 nautical miles. Comparing spectral levels, the noise at the bottom directly under a fishing vessel is about 110 dB re 1 $\mu\text{Pa}/\text{Hz}$, or just over the fish detection threshold, while the sound level from an air gun will be about 120 dB re 1 $\mu\text{Pa}/\text{Hz}$. The noise from an air gun array will thus exceed vessel noise, even at the edge of the trial area.

5.3 Time effect

Another problem formulated at the outset was determining how long after the shooting program was completed a possible effect on fish density and catch rates could last. The acoustic mapping showed no increase in the density of cod and haddock during the five days after the shooting ceased. The trawl catches also failed to show any increase during the same period. However, a return to the pre-shooting fish size distribution was suggested. During the shooting there was a marked decline in the average size of caught fish. This decline was greatest in the central region and less towards the periphery. These differences, depending on the distance from the shooting area, were disappearing as the trial was ending, most likely because the fish that remained in the area began to disperse in random fashion.

With longline an increase in the catches of cod was observed at the end of the trial period, but not in the catches of haddock. This is also an indication that the conditions began to normalize within a few days of completion of the shooting. Longline-catching depends, as earlier mentioned, on fish actively seeking the bait. Even if the fish density, as reflected in the trawl catches and acoustic abundance estimates, did not increase, the catch rate with longline could increase if the fish changed its feeding behavior towards the longline bait. It is possible that fish increase their search for food when the scaring effect of air guns ceases.

All in all the trawl catches showed no indications of normalizing five days after the shooting stopped, but the longline catches did change in a positive direction. The winter longline fishery for cod off the coast of Finnmark produced evidence for normalizing of catches near seismic vessels roughly one day after conclusion of shooting (Løkkeborg & Soldal 1993). In addition, the secondary catch of cod in shrimp trawls increased to its pre-shooting level approximately one day after the seismic vessel left the area (Løkkeborg & Soldal 1993). Clearly it is difficult to give a simple answer to the question of how much time it takes before catches return to their pre-shooting level after a period of shooting. Most likely this varies with season, locality, duration of shooting, and so forth. Factors such as the availability of food at the site, whether the fish are migrating, etc., will almost certainly also play an important role.

6. CONCLUSION

The trials on North Cape Bank showed that seismic shooting with air guns has an effect on fish distribution and catching rates for cod and haddock, not only locally within the area where the shooting takes place, but also in the surrounding area.

The total quantity of cod and haddock in the investigation area, as measured acoustically, was reduced by 45% compared to the pre-shooting quantity. The reduction was largest within and out to 5 nautical miles from the center of the shooting area. The fish quantity decreased in both the pelagic and bottom (lowest 10 m) parts of the water column.

The results from the catching trials agreed well with the acoustic abundance computations. When the shooting began, the catch rates for cod by trawling and haddock by trawling and longlining decreased by about 50% throughout the trial area. The reduction was greatest within the shooting area, where the decline in trawl catches was 70% compared to the level before the shooting began. The reduction in catch rates for cod by longlining were however less. Within the shooting area the reduction was 44%. This decreased gradually out towards the edge of the investigation area. At the most distant longline position (16-18 nautical miles) there was no change in the catch rates for cod.

The weight reduction in trawl and longline catches was larger than the number reduction for both cod and haddock. This was associated with the reduction in catch rates being larger for fish greater than 60 cm than for fish less than 60 cm. On longline the number of small fish was observed to increase during the shooting. The reason that the seismic shooting affects large fish more strongly than small fish is unknown.

Acoustic mapping and catch rates with the first trawl hauls taken after the start of shooting suggested that the fish reacted to noise from the air guns by swimming out to the side of the sound source and out of the trial area. No evidence was found for the hypothesis that the fish remained in the area, but distributed in such a way that it was not available for catching.

During the trial period the catching effort was large within the trial area, especially in the shooting area. However, the exploitation was not large enough to be able to explain the large reduction that was demonstrated in the acoustically measured abundance and in the catch rates by trawl and longline. A reduction in fish quantity as a consequence of exploitation would produce a gradual decline in the catch rates. The same decline could also be explained by avoidance of the area due to noise from the survey vessels. The trials demonstrated, however, a large and sharp decline in the catch quantity that coincided with the start of the shooting. This reduction can hardly be explained from either exploitation or vessel avoidance alone.

The size of the trial area, 40 x 40 nautical miles, was established on the basis of estimates of how far from an air gun array fish would be able to hear and react to the transmitted sound signal. Effects on both fish distribution and catch rates were found, however, over a larger area than was anticipated at the outset. Both the acoustic abundance estimates and catch rates indicated a reduction throughout the investigation area, out to 18 nautical miles. The longline catches of cod, however, were not reduced at the furthest longline position (16-18 nautical miles). The trials therefore do not give an exact answer to the question of how far the influence on catching extends.

The investigation also fails to answer the question of how long effects of seismic shooting will last after cessation of the shooting. No increase in fish quantity was observed in the area during the five days the trials continued after the shooting ended. The single exception was a small increase in the catch rates of cod by longline. A change in the length distribution in the trawl catches suggested a certain normalizing of conditions after the shooting.

7. ACKNOWLEDGEMENTS

Geco-Prakla is thanked for a fine collaboration during planning and execution of the investigation. The crews of "ACADEMIC SHATSKIY", "ANNY KRÆMER", "LORAN" and "STALLO" are thanked for their good efforts during the field trials. We would further thank our colleagues on cruise: Kaare A. Hansen, Ingvald Svellingen, Bjørn Totland, Anne Britt Skar Tysseand and Jan Tore Øvredal, together with all others who contributed to the completion of this report. Finally, we want to thank Mrs. and Mr. Foote who have translated this report from Norwegian, and Elen Hals is particularly thanked for editing the report.

We wish to thank Dr. Michael Pennington, National Marine Fisheries Service, Woods Hole, USA, for help with the statistical computations on the catch data. We also thank Dr. Kenneth Foote, Institute of Marine Research, for help with statistical computations on the acoustic data.

8. REFERENCES

- Aglen, A. 1983. Random errors of acoustic fish abundance estimates in relation to the survey grid density applied. *FAO Fish Rep.*, 300: 293-298.
- Anon. 1991. Oljedirektoratets årsberetning 1991. Oljedirektoratet, Stavanger.
- Blaxter, J.H.S., Gray, J.A.B. and Denton, E.J. 1981. Sound and startle response in herring shoals. *J. Mar. Biol. Assoc. U.K.*, 61(4): 851-870.
- Buerkle, U. 1968. An audiogram of the Atlantic cod, *Gadus morhua* L. *J. Fish. Res. Board Can.*, 25: 1155-1160.
- Chapman, C.J. and Hawkins, A.D. 1973. A field study of hearing in cod, *Gadus morhua* L. *J. Comp. Physiol.*, 85: 147-167.
- Dalen, J. and Raknes, A. 1985. Scaring effects on fish from three-dimensional seismic surveys. *Report FO 8504, Institute of Marine Research, Bergen, Norway*, 22 pp.
- Engås, A. and Godø, O.R. 1989. Escape of fish under the fishing line of a Norwegian sampling trawl and its influence on survey results. *J. Cons. int. Explor. Mer*, 45: 269-276.
- Engås, A., Misund, O.A., Soldal, A.V., Horvei, B. and Solstad, A. 1991. Fish Behaviour and Vessel Noise: Catch Data Comparisons, Noise Analysis, and Playback Experiments. In: A. Engås: *The Effects of Trawl Performance and Fish Behaviour on the Catching Efficiency of Sampling Trawls*. Dr. Philos-Thesis, University of Bergen, Institute of Fisheries and Marine Biology, Bergen, Norway: 59-68.
- Footte, K.G., Knudsen, H.P., Vestnes, G., MacLennan, D.N. and Simmonds, E.J. 1987. Calibration of acoustic instruments for fish density estimation: a practical guide. *ICES Cooperative Research Report*, 144, 69 pp.
- Greene, C.R. 1985. A pilot study of possible effects of marine seismic airgun array operation on rockfish plumes. Prepared for the Seismic Steering Committee by Greeneridge Sciences, Inc., Santa Barbara, California.
- Gytte, T. 1991. A new system for automatic STD data acquisition from randomly positioned observers. *ICES C.M. 1991/C:21*.
- Hawkins, A.D. 1977. Fish sizing by means of swimbladder resonance. *Rapp. P.-v. Réun. Cons. int. Explor. Mer*, 170: 122-129.
- Hawkins, A.D. 1981. The hearing abilities of fish. In: W.N. Tavolga, A.N. Popper and R.R. Fay (eds.) *Hearing and sound communication*. Springer-Verlag, New York, pp. 109-133.
- Hawkins, A.D. and Rasmussen, K.J. 1978. The calls of gadoid fish. *J. mar. biol. Ass. U.K.*, 58: 891-911.
- Knudsen, H.P. 1990. The Bergen Echo Integrator: an introduction. *J. Cons. int. Explor. Mer*, 47: 167-174.
- Knudsen, F., Enger, P.S. og Sand, O. 1992. Awareness reactions and avoidance responses to sound in juvenile Atlantic salmon, *Salmo salar* L. *J. Fish Biol.* 40: 523-534.
- Løkkeborg, S. 1991. Effects of a geophysical survey on catching success in longlining. *ICES C.M. 1991/B:40*, 9 pp.
- Løkkeborg, S. and Soldal, A.V., 1993. The influence of seismic exploration with airguns on cod (*Gadus morhua*) behaviour and catch rates. *ICES mar. Sci. Symp.*, 196, (in press).

- Løvik, A. and Hovem, J.M. 1979. An experimental investigation of swimbladder resonance in fishes. *J. Acoust. Soc. Am.*, 66(3): 850-854.
- Malme, C.I., Smith, P.W. and Miles, P.R. 1986. Characterization of geophysical acoustic survey sounds. OCS Study MMS-86-0032. Prepared by BBN Laboratories Inc., Cambridge, Massachusetts, for Batelle Memorial Institute under Contract No. 14-12-001-30273 to the Department of Interior, Mineral Management Service, Pacific Outer Continental Shelf Region, Los Angeles, California, 88 pp.
- Myrberg, A.A. 1980. Fish bio-acoustics: its relevance to the not so silent world. *Environ. Biol. Fishes*, 5(4): 297-304
- Nes, H. 1991. Operator Manual for Simrad EK-500, Scientific Echo Sounder. *Rapport P2170E, Simrad, Horten, oktober 1991.*
- Offut, G.G. 1974. Structures of the detection of acoustic stimuli in the Atlantic cod, *Gadus morhua*. *J. Acoust. Soc. Am.*, 56: 665-671.
- Olsen, K., Angell, J., Pettersen, F. and Løvik, A. 1983. Observed fish reactions to a surveying vessel with special reference to herring, cod, capelin and polar cod. *FAO Fish. Rep.*, 300: 131-138.
- Ona, E. 1988. Observations of cod reaction to trawling noise. *ICES FAST WG-meeting, Oostende, 20-22 April 1988.* 10 pp.
- Ona, E. and Godø, O.R. 1990. Fish reaction to trawling noise: the significance for trawl sampling. *Rapp. P.-v. Réun. Cons. int Explor. Mer*, 189: 159-166.
- Pearson, W.J., Skalski, J.R. and Malme, C.I. 1992. Effects of sounds from a geophysical survey device on behaviour of captive rockfish (*Sebastes* sp.). *Can. J. Fish. Aquat. Sci.*, 49: 1343-1356.
- Pennington, M. 1983. Efficient estimators of abundance, for fish and plankton surveys. *Biometrics*, 39: 281-286.
- Pennington, M. and Vølstad, J.H. 1991. Optimum size of sampling unit for estimating the density of marine populations. *Biometrics*, 47: 717-723.
- Pettigas, P. 1990. Geostatistics for fish acoustic surveys: precision of the abundance estimate and survey efficiency. *ICES C.M. 1990.* 27 pp.
- Pettigas, P. and Poulard, J.C. 1989. Applying stationary geostatistics to fisheries: a study on hake in the Bay of Biscay. *ICES C.M. 1989/G:62*, 21 pp.
- Platt, C. and Popper, A.N. 1981. Fine structure and function of the ear. In: W.N. Tavolga, A.N. Popper and R.R. Fay (eds.) *Hearing and sound communication*. Springer-Verlag, New York, pp. 4-38.
- Popper, A.N. and Platt, C. 1983. Sensory surface of saccule and lagena in the ears of ostariophysan fishes. *J. Morphol.*, 176(2): 121-130.
- Sand, O. and Karlsen, H.E. 1986. Detection of infrasound by the Atlantic Cod. *J. Exp. Biol.*, 125: 197-204.
- Saidel, W.M. and Popper, A.N. 1983. The saccule may be the transducer for directional hearing of nonostariophysine teleosts. *Exp. Brain Res.*, 50(1): 149-152.
- Schwarz, A.L. 1985. The behaviour of fishes in their acoustic environment. *Environ. Biol. Fishes*, 13(1): 3-15.
- Simmonds, E.J., Williams, N.J., Gerlotto, F. and Aglen, A. 1991. Survey design and analysis procedure: a comprehensive review of good practice. *ICES C.M. 1991/B:54*, 135 pp.

- Skalski, J.R., Pearson, W.H. and Malme, C.I. 1992. Effects of Sounds from a Geophysical Survey Device on Catch-per-Unit-Effort in a Hook-and-Line Fishery for Rockfish (*Sebastes* spp.) *Can. J. Fish. Aquat. Sci.*, 49: 1357-1365.
- Skud, B.E. 1978. Factors affecting longline catch and effort: III. Bait loss and competition. *Int. Pac. Halib. Comm. Sci. Rep.*, 64: 25-50.
- Snedecor, G.W. and Cochran, W.G. 1980. *Statistical methods*. Iowa State University Press, Ames, Iowa, 507 pp.
- Tavolga, W.N. Popper, A.N. and Fay, R.R. (eds.) 1981. *Hearing and sound communication*. Springer-Verlag, New York, 608 pp.
- Wardle, C.S. 1977. Effects of swimming speeds in fish. In: T.J. Pedley (ed.) *Scale Effects of Size on Swimming Speeds in Fish*. Academic Press, New York, pp. 299-313.

ACOUSTIC METHODOLOGY

The standard acoustic method of estimating fish abundance has been followed in the investigation. The method is thoroughly described in textbooks, such as those by Forbes & Nakken (1972), Johannesson & Mitson (1983), MacLennan & Simmonds (1992) and Simmonds et al. (1991). For clarification, a brief outline of the method is given here.

The echo integration method is based on a physical measurement of area density of fish, which is possible when the echo sounder is calibrated and accurately compensates for geometrical spreading and absorption of the transmitted sound pulse and received echo. How this is executed in the EK500 echo sounding system and Bergen Echo Integrator is described in detail by Nes (1992) and Knudsen (1990).

The echo integration equation,

$$\rho_A = \frac{s_A}{\langle \sigma \rangle} ,$$

consists of just three terms when the echo sonder is calibrated, namely

ρ_A = area density of fish (number of fish per square nautical mile),

s_A = average measured acoustic backscattering coefficient (square meters per square nautical mile),

$\langle \sigma \rangle$ = average acoustic backscattering cross section of an individual fish (square meters).

The area backscattering coefficient (s_A) is measured by summing all echoes, here expressed through the volume backscattering coefficient (s_V), within a specified depth interval from z_1 to z_2 , and further accumulated (or integrated) over a specified number of transmissions (pings):

$$s_A = 4\pi (1852)^2 \int_{z_1}^{z_2} s_V dz \quad .$$

Division of this sum by the number of pings over a given interval of sailed distance, for example, 1 nautical mile, gives a quantitative measure of "acoustic" density. This average often involves thousands of individual measurements, depending on the ping rate and vessel speed.

The frequency of measurement, or registration, both vertically and horizontally, is chosen by the operator, and will depend on the purpose of the investigation. The raw data will in all cases be stored ping by ping, with full, 1-m vertical resolution, such that further analyses may be performed on the same basic data.

The acoustic backscattering cross section of a single fish of the same species and size that is measured is expressed as $\langle\sigma\rangle$. This is the average contribution that an individual fish makes during echo integration, and its value is needed for converting acoustic measures of fish density to biological measures of the same. The backscattering cross section measures the capacity of the target to reflect or scatter sound back towards the transducer, hence depends on both the size and reflection properties of the target.

The average value of the acoustic cross section, or average "target strength", is known for a number of species as a function of fish size, both from experimental measurements and from measurements made *in situ* by means of the split-beam part of the EK500 (Foote 1987; MacLennan & Simmonds 1992). By means of such measurements on individual cod and haddock of various sizes, the Institute of Marine Research has established a size-dependent target strength relation for these species. This is now used in the abundance estimation of cod and haddock stocks in the Barents Sea:

$$TS = 20 \log L - 68 \quad (\text{dB}) \quad ,$$

where TS is the target strength, and L is the fish length in centimeters. As an example, a 100-cm-long cod will have an average target strength of -28 dB. Since this measure is logarithmic, conversion to a linear quantity must be effected, as by the definition of target strength given by Urick (1975):

$$TS = 10 \log(\langle\sigma\rangle/4\pi) ,$$

or, inverting,

$$\langle\sigma\rangle = 4\pi 10^{(TS/10)} .$$

This means that both species and size data are required from trawling in order to perform an accurate acoustic abundance estimation, in case trawl data must be used to estimate the average fish target strength.

Interpretation of the echogram and echo integrator data

When the echogram registrations and trawl catch data are available for a given region, the echograms are displayed on a workstation, and the echo integration system BEI (Knudsen 1990) is used for interpretation. During this process the registrations and acoustic measurements are analyzed in 5-nautical-mile sections, being assigned to fish scattering classes on the basis of a series of interpretation criteria and the degree of mixing in the trawl catches. The basic interpretation scheme employed by the Institute of Marine Research is described by Dalen & Nakken (1983). A further refinement of this method is now possible through the Bergen Echo Integrator (BEI), where thresholding can be effected instantaneously on the echogram image, and an arbitrary subdivision of the water column can be made. Fish scatterers that can be easily distinguished according to appearance, echo strength and position in the echogram image may be immediately separated out, while those that are mixed and

difficult to distinguish because of similar acoustic properties are separated later on the basis of data from trawl catches.

Trawl catches

Trawl catches taken inside of a given area, when considered representative of the acoustic registrations, are often combined. Weights are assigned in this process as the samples are representative of the fish quantity or only of fish length. When the trawl catches are coded in accordance with the Institute of Marine Research sampling protocols, a standard computer program is run to compute the abundance of each length group for each species, and eventually the abundance by age class.

For the simple case of a single species, the quantity in each length group is computed as follows:

Given an average acoustic value for a single species over a unit area, $\langle s_A \rangle$ (m^2/nm^2), and catch information from all pertinent trawl hauls, where the number of fish in length group i is n_i , the total number of fish in length group i is

$$N_i = \frac{s_A(n_i)L_i^2 A}{\langle \sigma_i \rangle \sum_{i=1}^{i=k} n_i L_i^2},$$

where $\langle \sigma_i \rangle$ is computed from the target strength-fish length relation for the average length in the i -th length group. Thus is allowance made for size-dependent differences in target strength, with small fish generally having lower target strengths than large fish. In the linear domain, the acoustic backscattering cross section is approximately proportional to the square of fish length.

The total quantity in terms of weight is computed according to the equation

$$W = \sum N_i \bar{w}_i ,$$

where the mean weight for each length group is computed from individual length-weight data, as measured during the cruise. In the case that a fish scatterer class includes two species that must be separated according to the catch, the expression is similar, but in the proportion of squared lengths for the respective species.

Table 1. Settings and calibration values for the EK-500, measured in Olderfjord, 1 May 1992.

Parameter/function	Setting	Comment
Frequency	38 kHz	
Absorption coefficient	10 dB/km	α , 38 kHz, sea water
Time-varied gain	20 logR	TVG factor
Depth range (most used)	0-500 m	Referred to transducer depth 3.5 m
Pulse duration	Medium	1.0 ms
Bandwidth	Wide	3.3 kHz (filter)
Transmitter power	2000 W	Maximum
Angle sensitivity	21.9	Phase/real angle
Two-way beam angle (10 log(Ψ))	-20.0 dB (for ES38-29 transducer)	Effective, ideal beam angle
Calibration		
Parameter	Setting	Comment
Sv - transducer gain	26.6 dB	for integration
TS - transducer gain	26.8 dB	for TS measurement
3-dB beamwidth	7.2°	for TS measurement
Alongships angle offset	0.0°	for TS measurement
Athwartships angle offset	0.0°	for TS measurement

References

- Dalen, J. & Nakken, O. 1983. On the application of the echo integration method. *ICES C.M.* 1983/B:19. 30 pp.
- Foote, K.G. 1987. Fish target strengths for use in echo integrator surveys. *J. Acoust. Soc. Am.* 82(3): 981-987.
- Forbes, S.T. & Nakken, O. 1972. Manual for methods for fisheries survey and appraisal. Part 2. The use of acoustic instruments for fish detection and abundance estimation. *FAO Man. Fish. Sci.* (5), 138 pp.
- Johannesson, K.A. & Mitson, R.B. 1983. Fisheries acoustics: a practical manual for biomass estimation. *FAO Fish. Tech. Pap.* 240. 249 pp.
- MacLennan, D.N. & Simmonds, E.J. 1991. *Fisheries Acoustics*. Chapman Hall, London, England. 336 pp.
- Urick, R.J. 1975. *Principles of underwater sound*. 2. ed., Mc. Graw-Hill Book Company, New York, 1975. 384 pp.

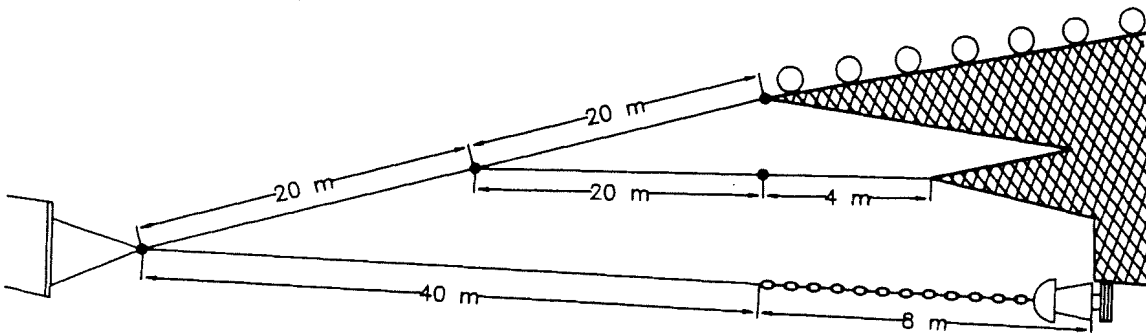
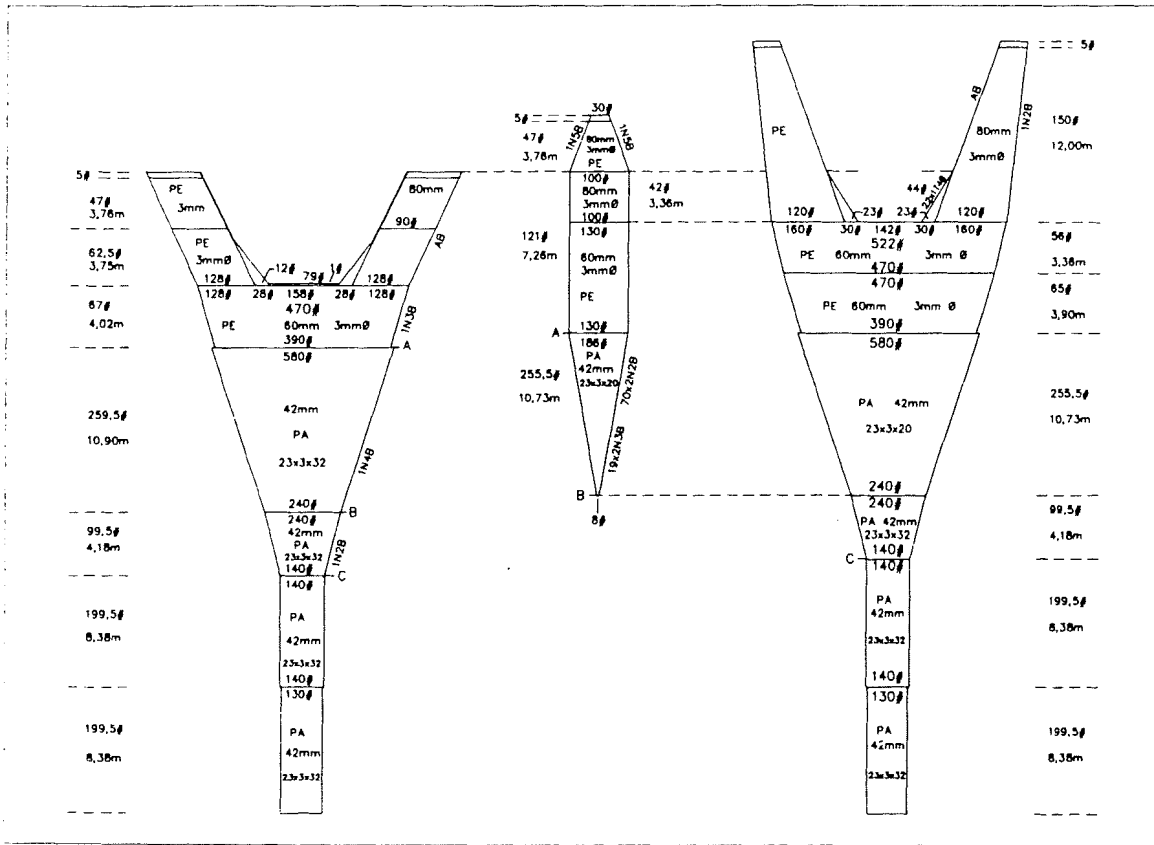

Figure 1. Standard sampling trawl, Campelen 1800, with specification of the rigging.

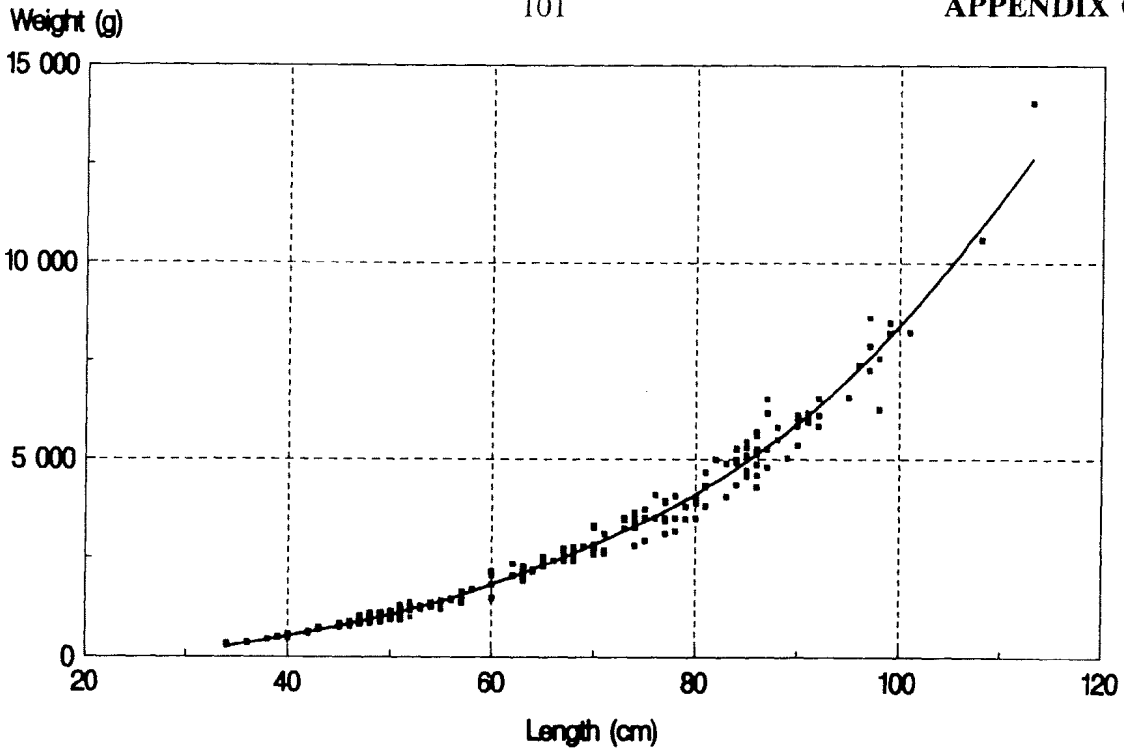

Figure 1. Length-weight curve for cod as caught by trawl with "ANNY KRÆMER".

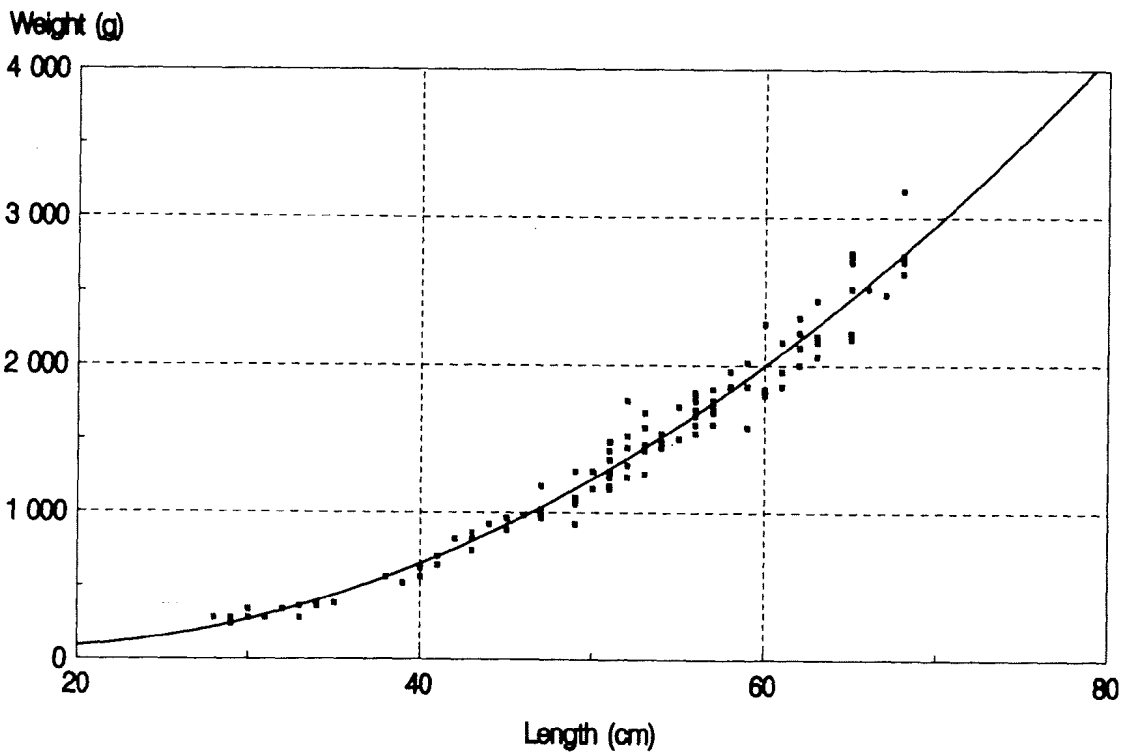

Figure 2. Length-weight curve for haddock as caught by trawl with "ANNY KRÆMER".

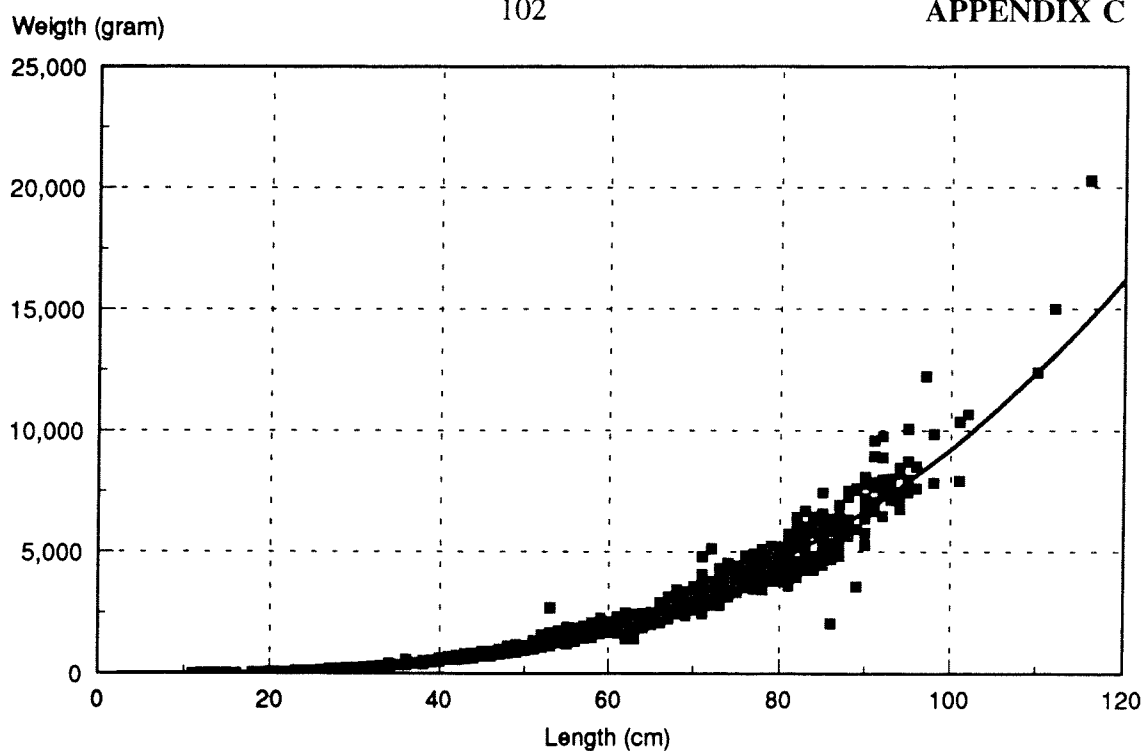

Figure 3. Length-weight relationship for cod in the southwestern part of the Barents Sea in 1992. Source: Demersal Fish Section, Institute of Marine Research. Fitted curve: $w = 6.30 \cdot 10^{-3} L^{3.083}$, weight w in grams, length L in centimeters.

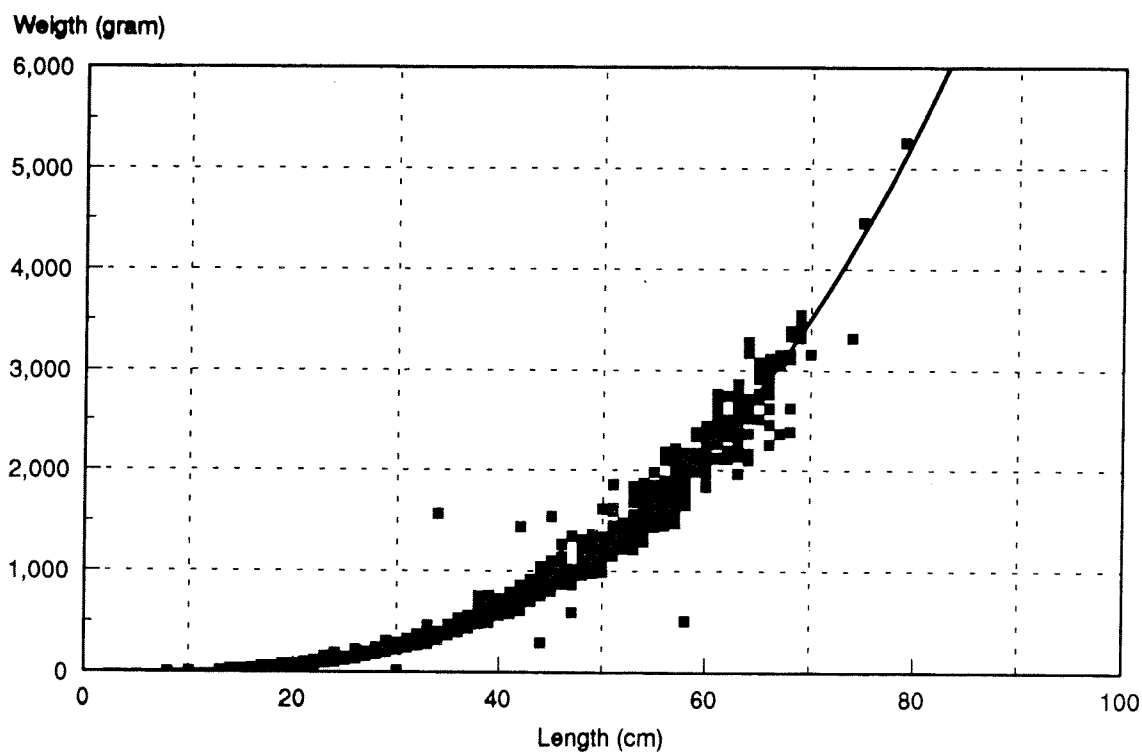

Figure 4. Length-weight relationship for haddock in the southwestern part of the Barents Sea in 1992. Source: Demersal Fish Section, Institute of Marine Research. Fitted curve: $w = 6.26 \cdot 10^{-3} L^{3.115}$, weight w in grams, length L in centimeters.

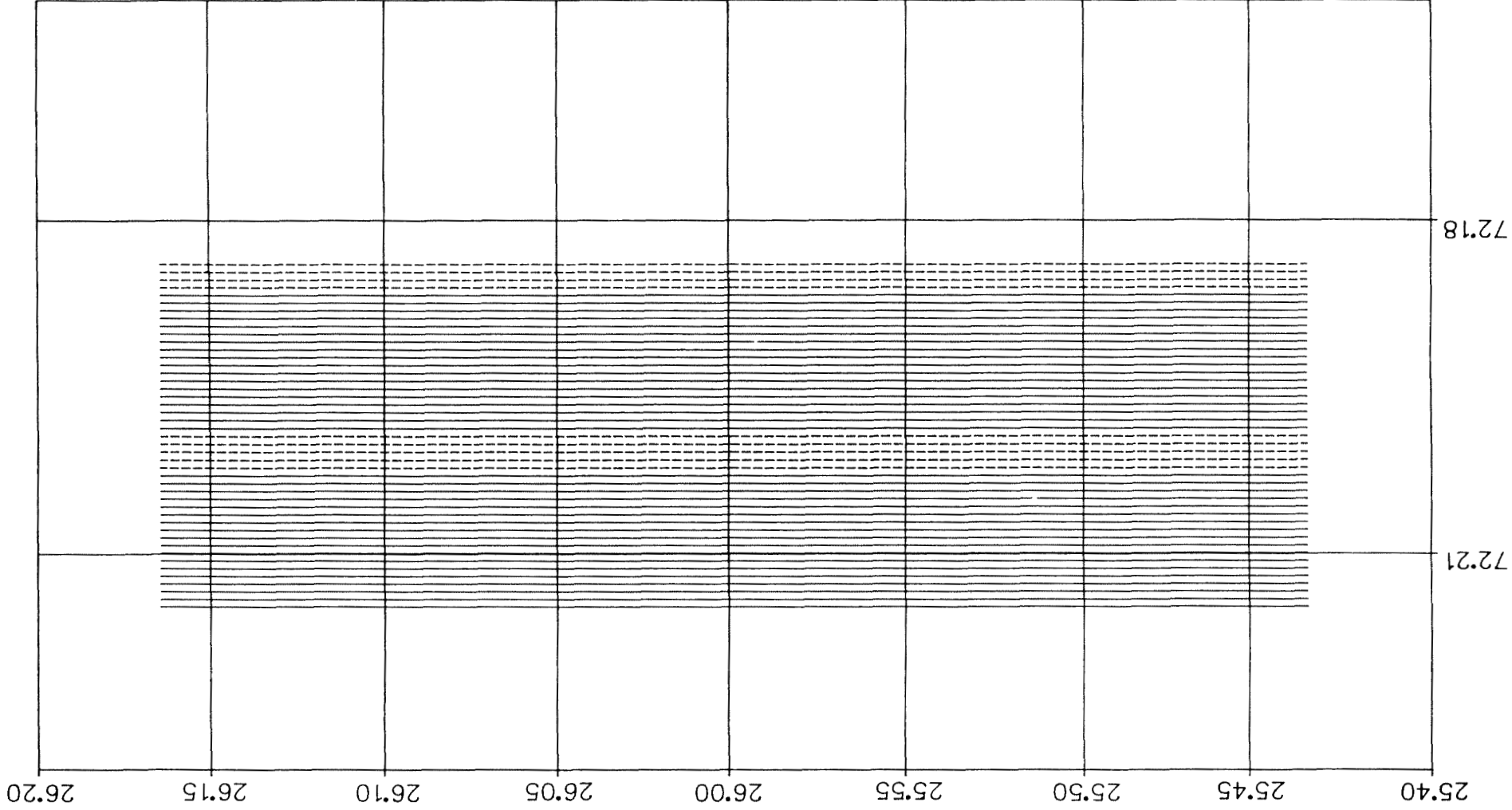

Fig. 1. Transects of "ACADEMIC SHATSKIY" during the trial period. The dashed lines are transects without shooting because of expiration of the contract time period.

Table 1. Average weight of cod in trawl catches by "ANNY KRÆMER", combined in time in relation to shooting and distance from the shooting area. N = number of trawl hauls, nm = nautical miles (distance from the shooting area).

	In shooting area			1-3 nm			7-9 nm			16-18 nm		
	N	Catch (kg/haul)	Standard error	N	Catch (kg/haul)	Standard error	N	Catch (kg/haul)	Standard error	N	Catch (kg/haul)	Standard error
Before shooting	12	556	56	16	535	75	16	460	83	16	417	67
During shooting	15	173	19	16	271	42	17	252	20	17	221	23
After shooting	12	202	14	16	255	39	16	249	29	16	200	22

Table 2. Average weight of haddock in trawl catches by "ANNY KRÆMER", combined in time in relation to shooting and distance from the shooting area. N = number of trawl hauls, nm = nautical miles (distance from the shooting area).

	In shooting area			1-3 nm			7-9 nm			16-18 nm		
	N	Catch (kg/haul)	Standard error	N	Catch (kg/haul)	Standard error	N	Catch (kg/haul)	Standard error	N	Catch (kg/haul)	Standard error
Before shooting	12	35.3	6.3	16	25.4	4.4	16	20.4	4.1	16	18.7	7.2
During shooting	15	11.2	1.5	16	11.1	1.2	17	9.0	1.4	17	5.5	1.2
After shooting	12	10.7	1.8	16	7.2	1.0	16	5.9	1.2	16	7.8	1.6

Table 3. Average number of small (<60 cm) and large (≥60 cm) cod in trawl catches by "ANNY KRÆMER" before, during and after shooting. N = number of trawl hauls, nm = nautical miles (distance from the shooting area).

		In shooting area			1-3 nm			7-9 nm			16-18 nm		
		N	Catch (no/haul)	Standard error	N	Catch (no/haul)	Standard error	N	Catch (no/haul)	Standard error	N	Catch (no/haul)	Standard error
S m a l l	Before shooting	12	76.8	7.7	16	77.5	12.8	16	62.7	9.3	16	60.3	12.9
	During shooting	15	63.7	7.8	16	84.5	14.3	17	57.7	7.7	17	33.3	2.9
	After shooting	12	58.2	7.5	16	54.6	8.8	16	51.2	7.4	16	31.0	5.7
L a r g e	Before shooting	12	110.4	11.4	16	96.9	9.1	16	75.3	7.8	16	80.6	10.1
	During shooting	15	27.5	3.2	16	47.3	7.4	17	47.8	4.0	17	45.6	5.4
	After shooting	12	36.4	2.1	16	45.7	4.6	16	49.4	5.5	16	41.7	4.8

Table 4. Average number of small (<60 cm) and large (≥60 cm) haddock in trawl catches by "ANNY KRÆMER" before, during and after shooting. N = number of trawl hauls, nm = nautical miles (distance from the shooting area).

		In shooting area			1-3 nm			7-9 nm			16-18 nm		
		N	Catch (no/haul)	Standard error	N	Catch (no/haul)	Standard error	N	Catch (no/haul)	Standard error	N	Catch (no/haul)	Standard error
S m a l l	Before shooting	12	76.8	7.7	16	77.5	12.8	16	62.7	9.3	16	60.3	12.9
	During shooting	15	63.7	7.8	16	84.5	14.3	17	57.7	7.7	17	33.3	2.9
	After shooting	12	58.2	7.5	16	54.6	8.8	16	51.2	7.4	16	31.0	5.7
L a r g e	Before shooting	12	110.4	11.4	16	96.9	9.1	16	75.3	7.8	16	80.6	10.1
	During shooting	15	27.5	3.2	16	47.3	7.4	17	47.8	4.0	17	45.6	5.4
	After shooting	12	36.4	2.1	16	45.7	4.6	16	49.4	5.5	16	41.7	4.8

Table 5. Average catch of cod (kg/fleet) by the longliner "LORAN", combined in time in relation to shooting and distance from the shooting area. N = number of longline fleets, nm = nautical miles (distance from the shooting area).

	In shooting area			1-3 nm			7-9 nm			16-18 nm		
	N	Catch (kg/fleet)	Standard error	N	Catch (kg/fleet)	Standard error	N	Catch (kg/fleet)	Standard error	N	Catch (kg/fleet)	Standard error
Before shooting	14	793	44	14	784	39	14	954	55	14	882	60
During shooting	10	437	38	10	647	59	10	700	49	10	926	73
After shooting	9	580	49	9	802	35	8	863	65	9	712	67

Table 6. Average catch of haddock (kg/fleet) by the longliner "LORAN", combined in time in relation to shooting and distance from the shooting area. N = number of longline fleets, nm = nautical miles (distance from the shooting area).

	In shooting area			1-3 nm			7-9 nm			16-18 nm		
	N	Catch (kg/fleet)	Standard error	N	Catch (kg/fleet)	Standard error	N	Catch (kg/fleet)	Standard error	N	Catch (kg/fleet)	Standard error
Before shooting	14	306	51	14	247	38	14	215	21	14	173	27
During shooting	10	100	4	10	124	10	10	121	14	10	85	6
After shooting	9	84	6	9	95	13	8	109	13	9	104	22

Table 7. Average number of small (<60 cm) and large (≥60 cm) cod in longline catches by "LORAN" before, during and after shooting. N = number of longline fleets, nm = nautical miles (distance from the shooting area).

		In shooting area			1-3 nm			7-9 nm			16-18 nm		
		N	Catch (no/fleet)	Standard error	N	Catch (no/fleet)	Standard error	N	Catch (no/fleet)	Standard error	N	Catch (no/fleet)	Standard error
S m a l l	Before shooting	14	88	8	14	87	6	14	83	9	14	51	7
	During shooting	10	145	10	10	139	12	10	113	9	10	97	6
	After shooting	9	147	12	9	144	9	8	134	8	9	73	10
L a r g e	Before shooting	14	174	11	14	175	10	14	214	13	14	196	13
	During shooting	10	75	7	10	128	13	10	142	11	10	202	18
	After shooting	9	112	13	9	164	9	8	185	15	9	159	17

Table 8. Average number of small (<60 cm) and large (≥60 cm) haddock in longline catches by "LORAN" before, during and after shooting. N = number of longline fleets, nm = nautical miles (distance from the shooting area).

		In shooting area			1-3 nm			7-9 nm			16-18 nm		
		N	Catch (no/fleet)	Standard error	N	Catch (no/fleet)	Standard error	N	Catch (no/fleet)	Standard error	N	Catch (no/fleet)	Standard error
S m a l l	Before shooting	14	104	11	14	96	12	14	90	13	14	65	13
	During shooting	10	81	5	10	96	7	10	87	10	10	58	11
	After shooting	9	59	5	9	64	6	8	69	13	9	46	7
L a r g e	Before shooting	14	84	18	14	62	13	14	53	7	14	44	9
	During shooting	10	13	1	10	19	4	10	19	6	10	14	4
	After shooting	9	14	1	9	17	4	8	19	3	9	25	9

CATCH DATA STATISTICS

Trawling

Table 1 shows the most important statistical parameters for cod, where y (see model (1) in "Materials and methods") is the logarithm of the weight per haul. Interaction effects that are based on the cell average are not significant ($p=0.12$). This indicates that the effect of the seismic shooting is not dependent on distance within the investigated area. Figure 1 shows the cell averages. Since the effects of interactions are not significant, the main effects may be considered. The distance effect is not significant ($p=0.19$). Although this is not of direct interest to the study, it indicates that the density of cod was quite uniform over the entire area of investigation. The time effect, however, is highly significant ($p<0.001$). Figure 2 shows computed average weights within the entire area, viewed integrally, together with the 95% confidence interval for the three time periods. The catch rate fell significantly during the shooting, and it appears not to have increased during the five days the investigation continued after conclusion of the shooting.

Table 1. Analysis of variance for the total weight of cod in the trawl catches. The weights are given in logarithmic units.

Source of variation	Sum of squares	Degrees of freedom	Average sum of squares	F	Significance level
Main effects					
Time	20.99	2	10.49	44.67	0.000
Distance	1.13	3	0.37	1.60	0.190
Interaction					
Time*Distance	2.42	6	0.40	1.72	0.118
Residual	40.64	173	0.23		
Total (corrected)	64.43	184			

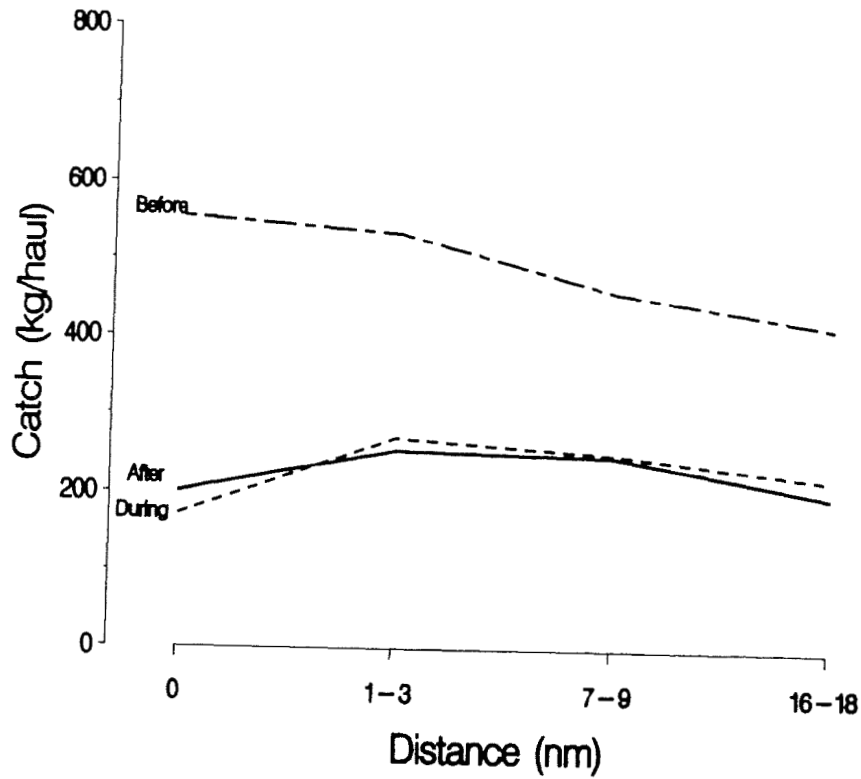

Figure 1. Average trawl-catch rates for cod, combined over time in relation to shooting and by distance from the shooting area.

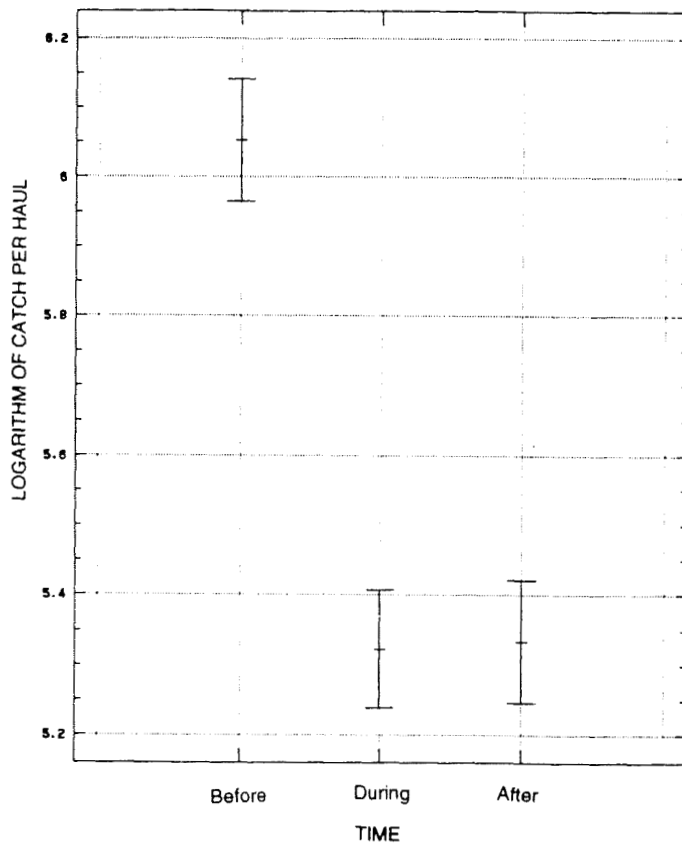

Figure 2. Average catches of cod, with confidence interval, before, during and after shooting.

The suitability of the model (1) for cod data was evaluated by standard diagnostic control of the residuals (see, for example, Box et al. 1978). No lack of fitting was found except when the residuals were treated as a time series (for example, as a function of the collection sequence), where a weak autocorrelation was found ($r=0.2$). However, since the hauls at different distances were made in a different sequence during the trial period, this will not have a significant effect on the computed probability levels in the model.

As a final check on the significance of the reduction in catch after the shooting began, a time series model was used to analyze the data (Box & Jenkins 1976). An intervention analysis (Box & Tiao 1975) demonstrated that there was a 50% reduction in catch after the shooting began.

The results from the statistical analyses of trawl-catch rates for haddock resembled those for cod (Table 2). Interaction effects were not significant ($p=0.56$). The main effect for distance was however significant ($p<0.001$), which indicates that the density of haddock varied over the trial area. As is apparent from Fig. 3, the density of haddock was greatest in the center, decreasing towards the periphery of the trial area. The time effect was also highly significant ($p<0.001$). Average catch rates over the entire area are presented in Fig. 4. As was the case for cod, the trawl catch rates for haddock fell during the shooting and seemed not to have increased as long as the investigation continued.

Table 2. Analysis of variance for the total weight of haddock in the trawl catches. The weights are given in logarithmic units.

Source of variation	Sum of squares	Degrees of freedom	Average sum of squares	F	Significance level
Main effects					
Time	28.14	2	14.07	22.67	0.000
Distance	17.29	3	5.76	9.28	0.000
Interaction					
Time*Distance	3.03	6	0.50	0.81	0.559
Residual	107.36	173	0.62		
Total (corrected)	154.73	184			

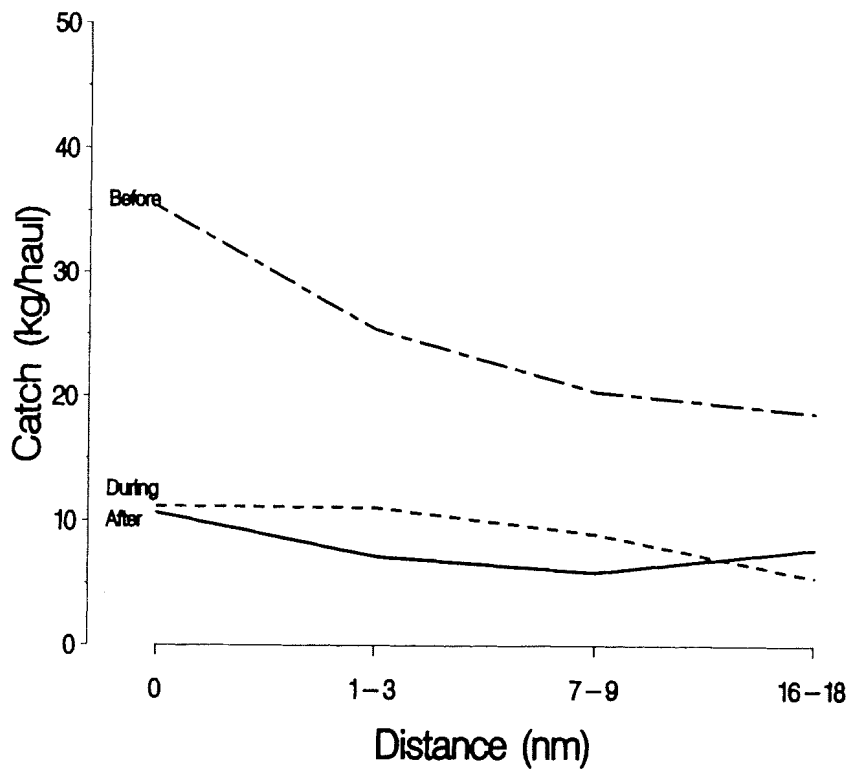

Figure 3. Average trawl-catch rates for haddock combined over time in relation to shooting and by distance from the shooting area.

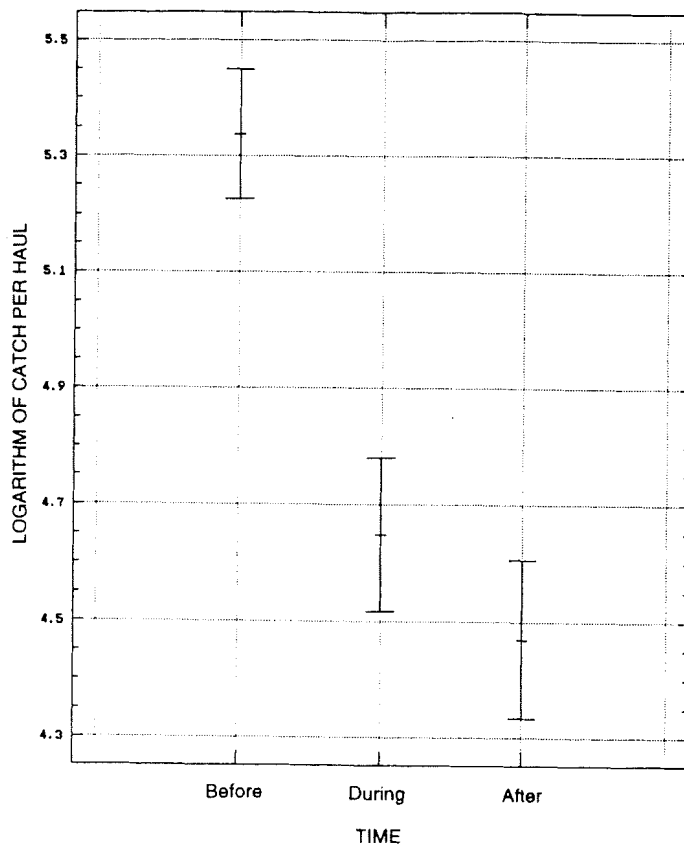

Figure 4. Average catches of haddock, with confidence interval, before, during and after shooting.

Longlining

Table 3 shows the statistical results for cod caught by longlining. Interaction effects between time and distance are significant ($p < 0.001$) and consequently the main effects specified in the model are meaningless. Figure 5 shows the cell averages. It appears that the catch decreased in the central area, but that the effect was less in the border regions of the investigation area. Since interaction effects were significant, it is futile to present the average catch rates for cod caught by longlining in a diagram corresponding to those of Figs. 1 and 3.

Table 3. Analysis of variance for the total weight of cod in the longline catches. The weights are given in logarithmic units.

Source of variation	Sum of squares	Degrees of freedom	Average sum of squares	F	Significance level
Main effects					
Time	0.85	2	0.42	11.68	0.000
Distance	1.29	3	0.43	11.71	0.000
Interaction					
Time*Distance	0.98	6	0.16	4.46	0.001
Residual	2.02	55	0.03		
Total (corrected)	5.01	66			

For haddock caught by longlining the interaction effect and distance effect were not significant (Table 4). There was, however, a time effect ($p < 0.001$). That is, there was a significant reduction in the catches of haddock during the shooting that seem to be the same over the entire trial area. The decrease in catch was about 50%. Figure 6 shows the cell averages, and Fig. 7 shows the average catches in the area for the three time periods, together with the corresponding 95% confidence intervals.

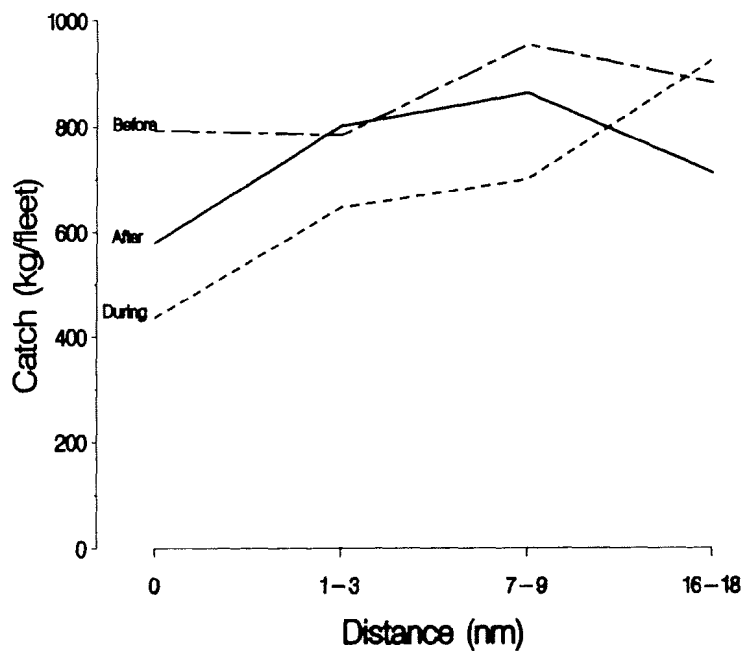

Figure 5. Average longline catch rates for cod, combined over time in relation to shooting and by distance from the shooting area.

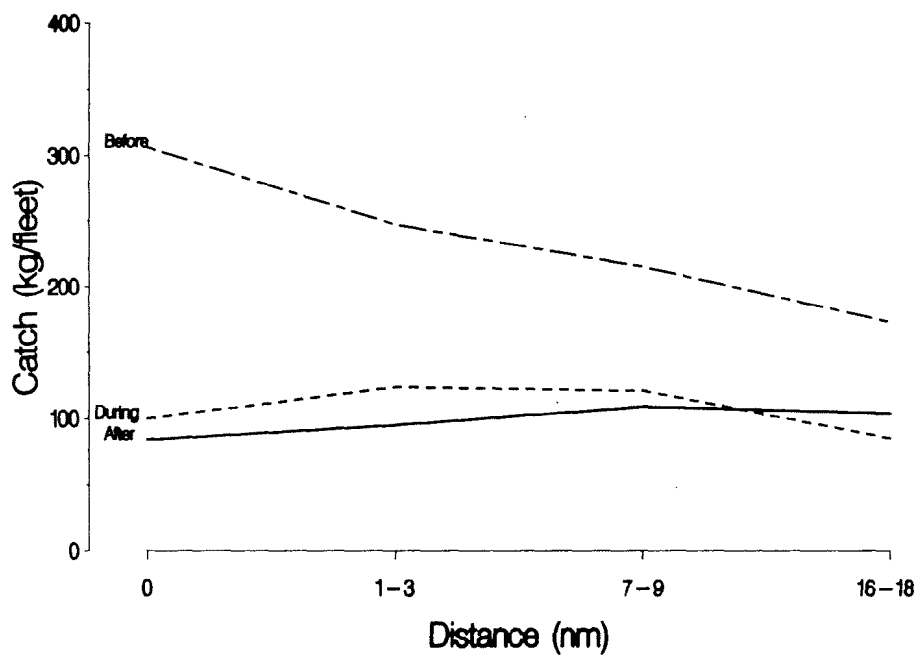

Figure 6. Average longline catch rates for haddock, combined over time in relation to shooting and by distance from the shooting area.

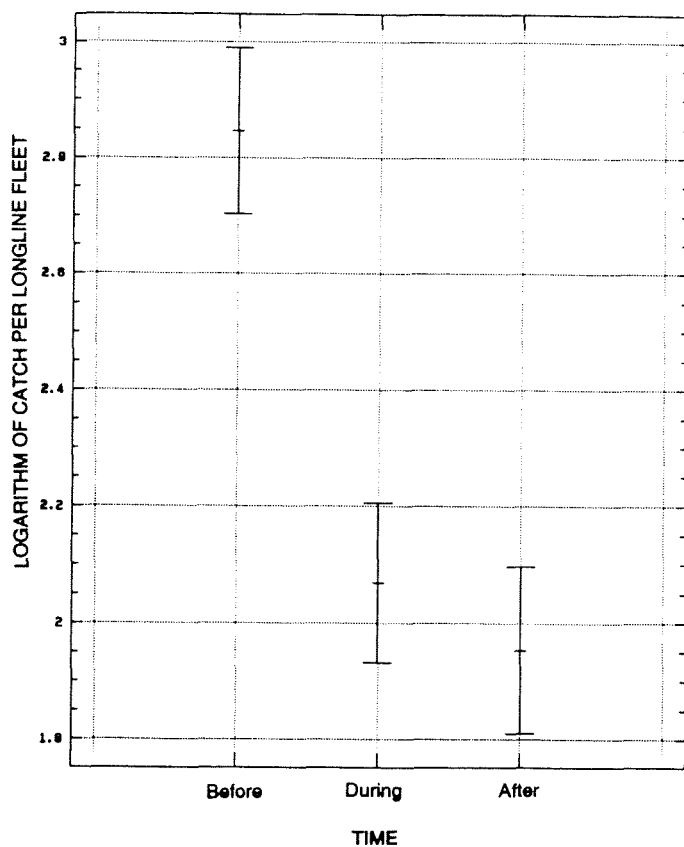

Figure 7. Average catch rates for haddock, with confidence interval, before, during and after shooting.

Average individual weights

The average individual weight of cod and haddock caught by trawl decreased (cod: $p < 0.001$, haddock: $p = 0.06$) when the shooting started (Tables 5 and 6). For cod this reduction was greatest within the central region (Fig. 4.2.11), gradually decreasing towards the periphery of the trial area. At the most remote trawling station (16-18 nautical miles from the shooting area) there was no significant change in the individual weight of cod. It appears that the weight began to increase somewhat again at the end of the trial period, after the shooting had ceased, but this increase was not significant. For haddock, changes in individual weight depending on distance from the shooting area and time in relation to the shooting (Fig. 4.2.12) were not as clear.

Table 4. Analysis of variance for the total weight of haddock in the longline catches. The weights are given in logarithmic units.

Source of variation	Sum of squares	Degrees of freedom	Average sum of squares	F	Significance level
Main effects					
Time	10.10	2	5.05	29.28	0.000
Distance	0.75	3	0.25	1.44	0.238
Interaction					
Time*Distance	0.80	6	0.13	0.77	0.592
Residual	9.49	55	0.17		
Total (corrected)	21.42	66			

Table 5. Analysis of variance for individual weight of cod in the trawl catches.

Source of variation	Sum of squares	Degrees of freedom	Average sum of squares	F	Significance level
Main effects					
Time	6.42	2	3.21	16.11	0.000
Distance	7.25	3	2.41	12.13	0.000
Interaction					
Time*Distance	3.78	6	0.63	3.16	0.005
Residual	34.46	173	0.19		
Total (corrected)	51.93	184			

Table 6. Analysis of variance for individual weight of haddock in the trawl catches.

Source of variation	Sum of squares	Degrees of freedom	Average sum of squares	F	Significance level
Main effects					
Time	1.01	2	0.51	2.87	0.060
Distance	0.27	3	0.09	0.31	0.675
Interaction					
Time*Distance	0.69	6	0.11	0.64	0.699
Residual	29.88	169	0.18		
Total (corrected)	31.85	180			

References

- Box, G.E.P., Hunter, W.G. and Hunter, J.S. 1978. *Statistics for Experimenters*. Wiley, New York, 653pp.
- Box, G.E.P. and Jenkins, G.M. 1976. *Time Series Analysis: forecasting and control*. Holden-Day, Oakland, CA, 575pp.
- Box, G.E.P. and Tiao, G.C. 1975. Intervention analysis with applications to economic and environmental problems. *J. Amer. Stat. Ass.*, 70: 70-79.

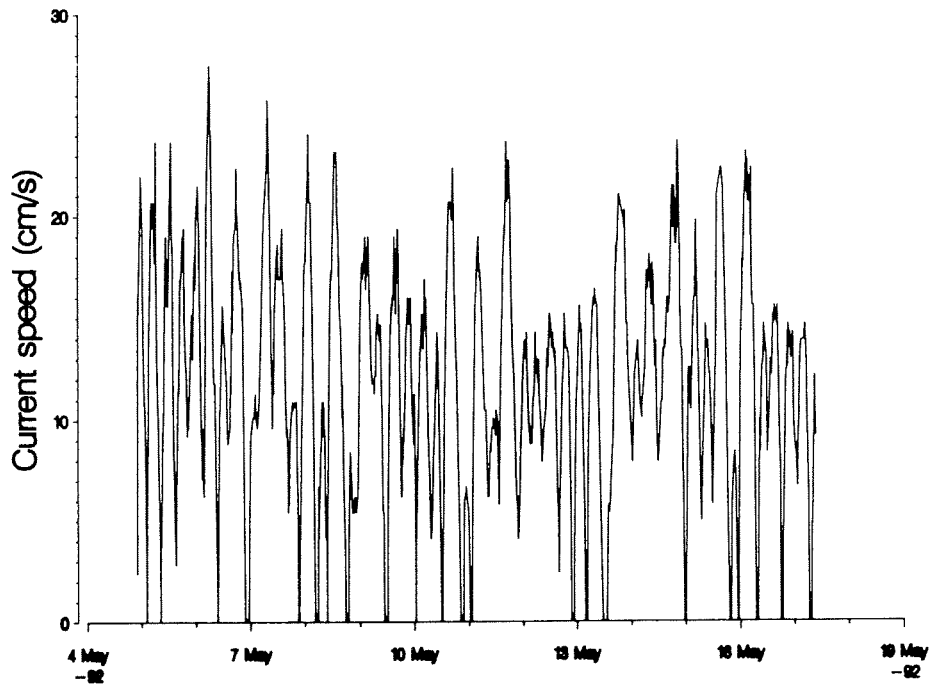

Figure 1. Current speed measured on North Cape Bank during the trial period.

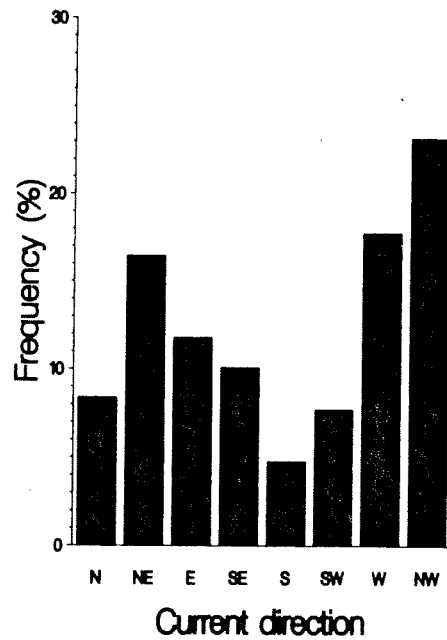

Figure 2. Frequency distribution of current direction during the trials on North Cape Bank.

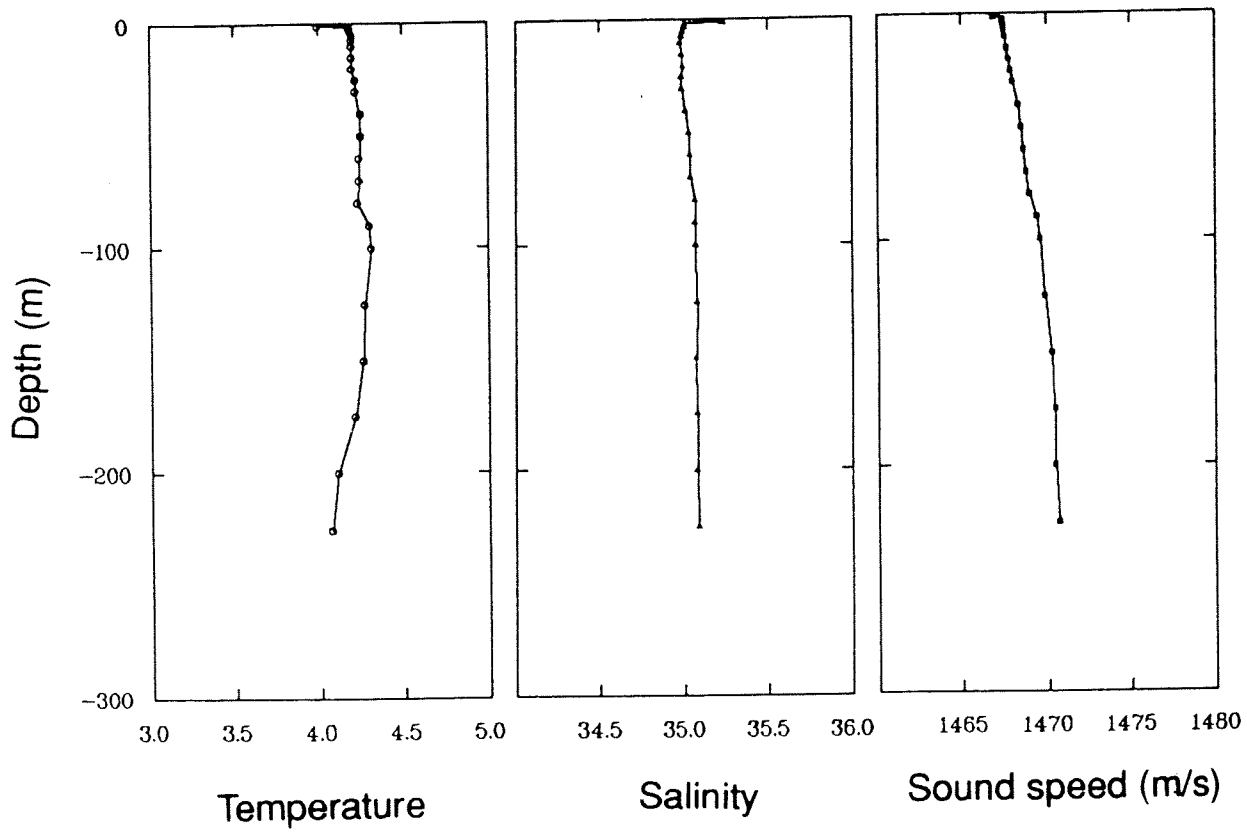

Figure 3. A typical vertical profile of temperature, salinity and sound speed, 0-250 m depth, in the center of the area.