

# report on oceanographic cruises and data stations

1976

Harald Kismul

fiskeridirektoratets  
havforskningsinstitutt

Bergen - Norge

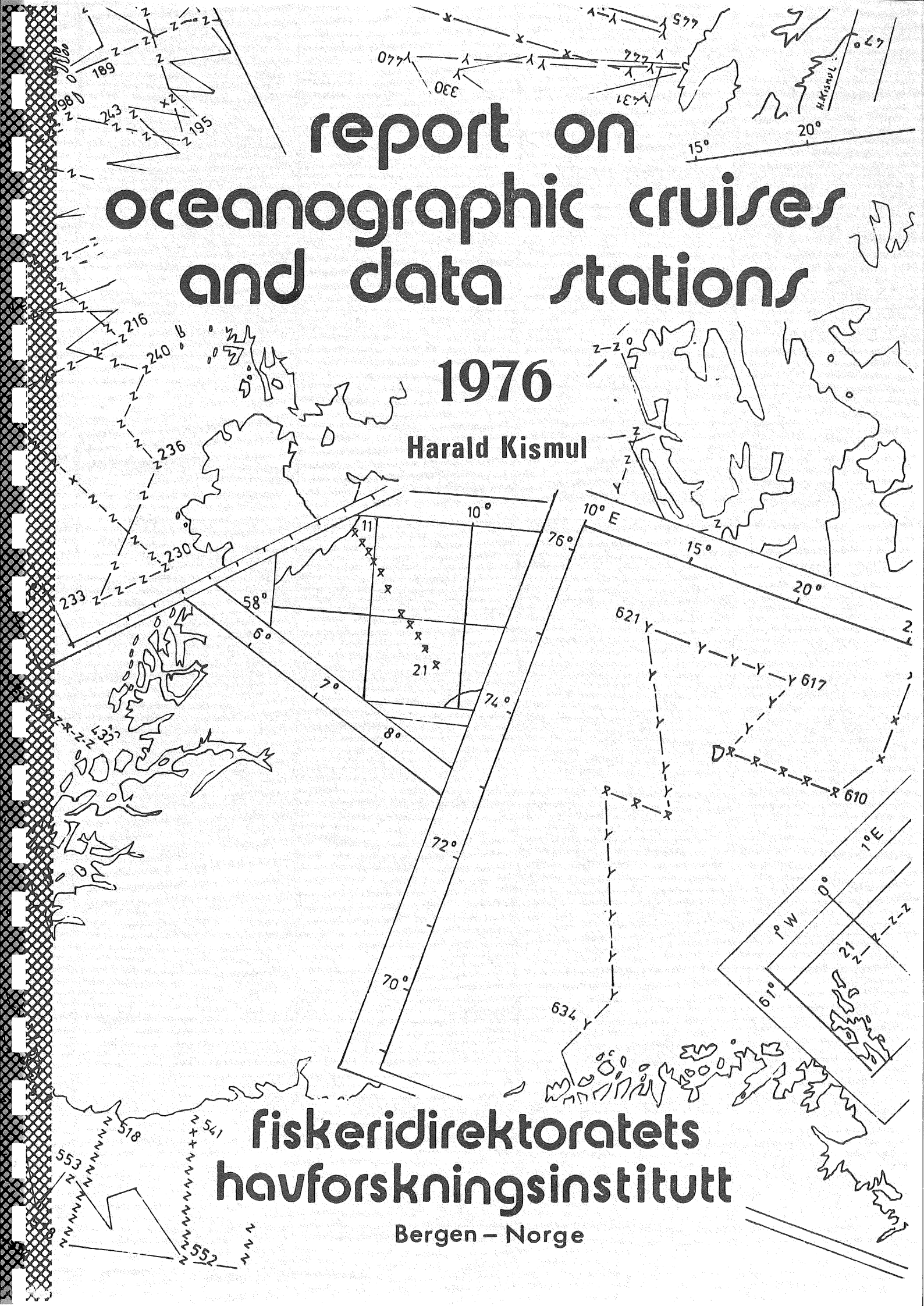

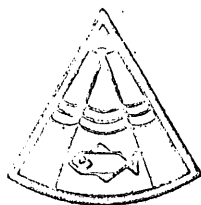

# report on oceanographic cruises and data stations

1976

HARALD KISMUL

## Guidelines:

- λ Classical oceanogr. stations
- Z Vertical profiles (STD/CTD)
- Y Bathythermograph (BT)
- Δ Moored buoy station
- △ Pelagic Trawl station
- Bottom Trawl station
- ◇ Plankton station
- Clarke
- Taggings
- Λ Surface observations t°C S<sup>o</sup>/oo

fiskeridirektoratets  
havforskningsinstitutt

Bergen - Norge



ICES Annual Report on Oceanographic Cruises and Data Stations.

Country: NORWAY

Year: 1976

Ship: "Johan Hjort"

No. 12.

Cruise and ship number.	Period of cruises	Number of Stations													Continual observations					Page of track chart								
		Classical oceanogr. stations	Vertical profiles (STD/CTD)	Bathythermograph (BT)	Moored Buoy	Oxygen	Nutrients	Oil Hydrocarbons	Petroleum residues	Metals	Primary org. prod.	Petrop plank. pigment con.	Sediment samples	Pelagic Trawl	Bottom Trawl	Pelagic eggs and larvae	Taggings	Zooplankton	Phytoplankton		Surface temperature	Transparency	Organic matter (extract.)	Part. matter (filtration)	NO <sub>2</sub> + NO <sub>3</sub> (auto-analyzer)	Echo sounding	Echo integration	
1/12	12/1 - 31/1	3	35										26	4												x	x	5
2/12	10/1 - 5/3	3	78				12							56												x	x	6 - 7
3/12	12/3 - 10/4	13	10	1																						x	x	8
4/12	21/4 - 12/5	69														165										x	x	9
5/12	24/5 - 4/7	34	182	5			12						56	7	163											x	x	10 - 11
6/12	16/8 - 23/8	45				8								1												x	x	12
7/12	25/8 - 7/9	44												2												x	x	13
8/12	11/9 - 1/10	39																								x	x	14
9/12	4/10 - 12/10	35				17																				x	x	15
10/12	01/11 - 15/12	138																								x	x	16-17-18-19

## ICES Annual Report on Oceanographic Cruises and Data Stations.

Country: NORWAY

Year: 1976

Ship: "G.O. Sars"

No. 15.

Cruise and ship number.	Period of cruises	Number of Stations																Continual observations						Page of track chart			
		Classical oceanogr. stations	Vertical profiles (STD/CTD)	Bathythermograph (BT)	Moored Buoy	Oxygen	Nutrients	Oil Hydrocarbons	Petroleum residues	Metals	Primary org. prod.	Petroplank. pigment con.	Sediment samples	Pelagic Trawl	Bottom Trawl	Pelagic eggs and larvae	Taggings	Zooplankton	Phytoplankton	Surface temperature	Transparency	Organic matter (extract.)	Part. matter (filtration)		NO <sub>2</sub> + NO <sub>3</sub> (auto-analyzer)	Echo sounding	Echo integration
1/15	14/1 - 30/1	26		35									20	1					x	x					x	x	20
2/15	2/2 - 4/3	62		43									24	14					x	x					x	x	21 - 22
3/15	14/3 - 12/4	55											33	16					x	x					x	x	23 - 24
4/15	25/5 - 7/6	117																	x	x					x	x	25
5/15	9/6 - 9/7	3	84	1									74	1	103				x	x					x	x	26 - 27
6/15	11/7 - 11/8		162										35	8	4				x	x					x	x	28 - 29
7/15	25/8 - 8/9	9	52										64		9				x	x					x	x	30
8/15	11/9 - 1/10	54		11									45	1					x	x					x	x	31
9/15	4/10 - 8/11	17		95									13	48					x	x					x	x	32-33-34
10/15	16/11 - 12/12	4	156										20	3					x	x					x	x	35 - 36

ICES Annual Report on Oceanographic Cruises and Data Stations.

Country: NORWAY

Year: 1976

Ship: Peder Rønnestad No.14., G.M. Dannevig No.16, Havdrøn No.20.

Cruise and ship number.	Period of cruises	Number of Stations																Continual observations				Page of track chart					
		Classical oceanogr. stations	Vertical profiles (STD/CTD)	Bathythermograph (BT)	Moored Buoy	Oxygen	Nutrients	Oil Hydrocarbons	Petroleum residues	Metals	Primary org. prod.	Petroplank. pigment con.	Sediment samples	Pelagic Trawl	Bottom Trawl	Pelagic eggs and larvae	Taggings	Zooplankton	Phytoplankton	Surface temperature	Transparency		Organic matter (extract.)	Part. matter (filtration)	NO <sub>2</sub> + NO <sub>3</sub> (auto-analyzer)	Echo sounding	Echo integration
14	5/5 - 12/5	12		13													74		x								37
14	21/5 - 1/6	99															68		x								38
14	12/6 - 18/6	17		7													47		x								39
16	13/1 - 16/11	88				x													x								40
16	21/1 - 16/12	208				x													x								41
16	4/2 - 12/11	189				189											189	189	x								42
16	3/8 - 22/11	19																	x								43
16	13/9 - 29/10	41				x													x								44
20	19/10 - 25/10																74		x								45
20	25/11 - 16/2													4					x					x	x		46



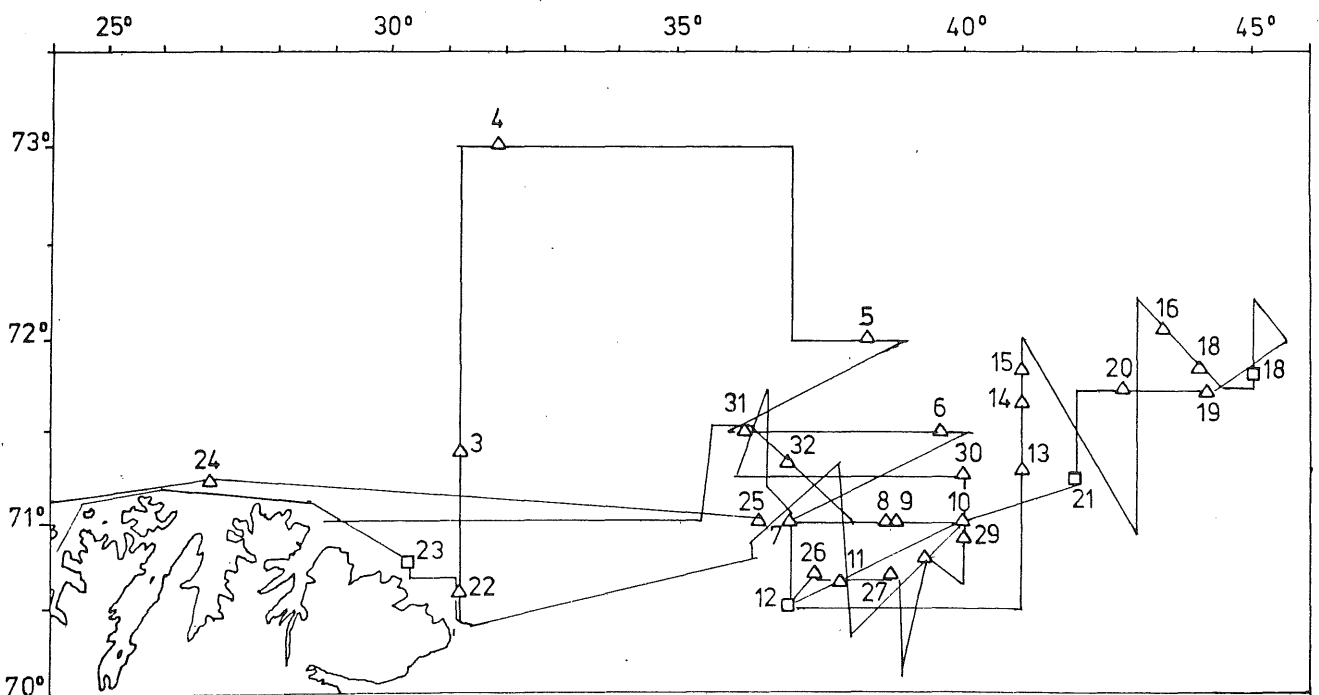
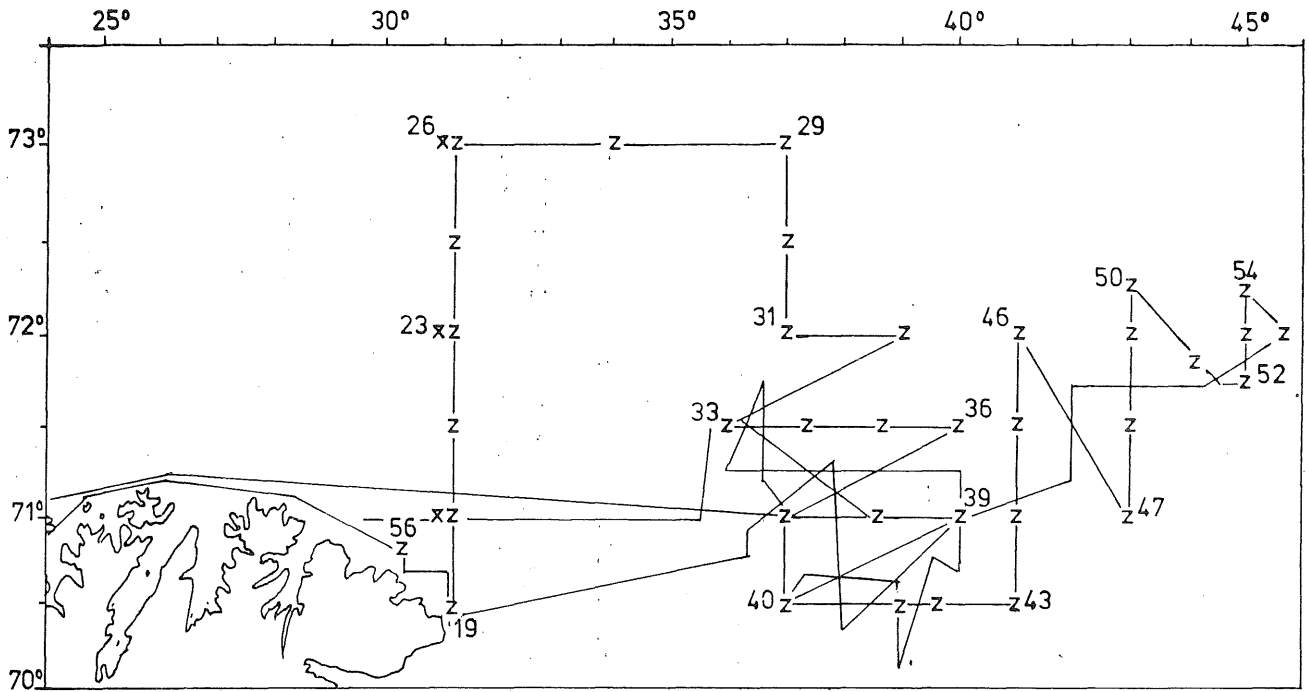

12-31 JAN. 1975

ST. NO. 19-56

TRAWL ST. 3-32

„JOHAN HJORT“



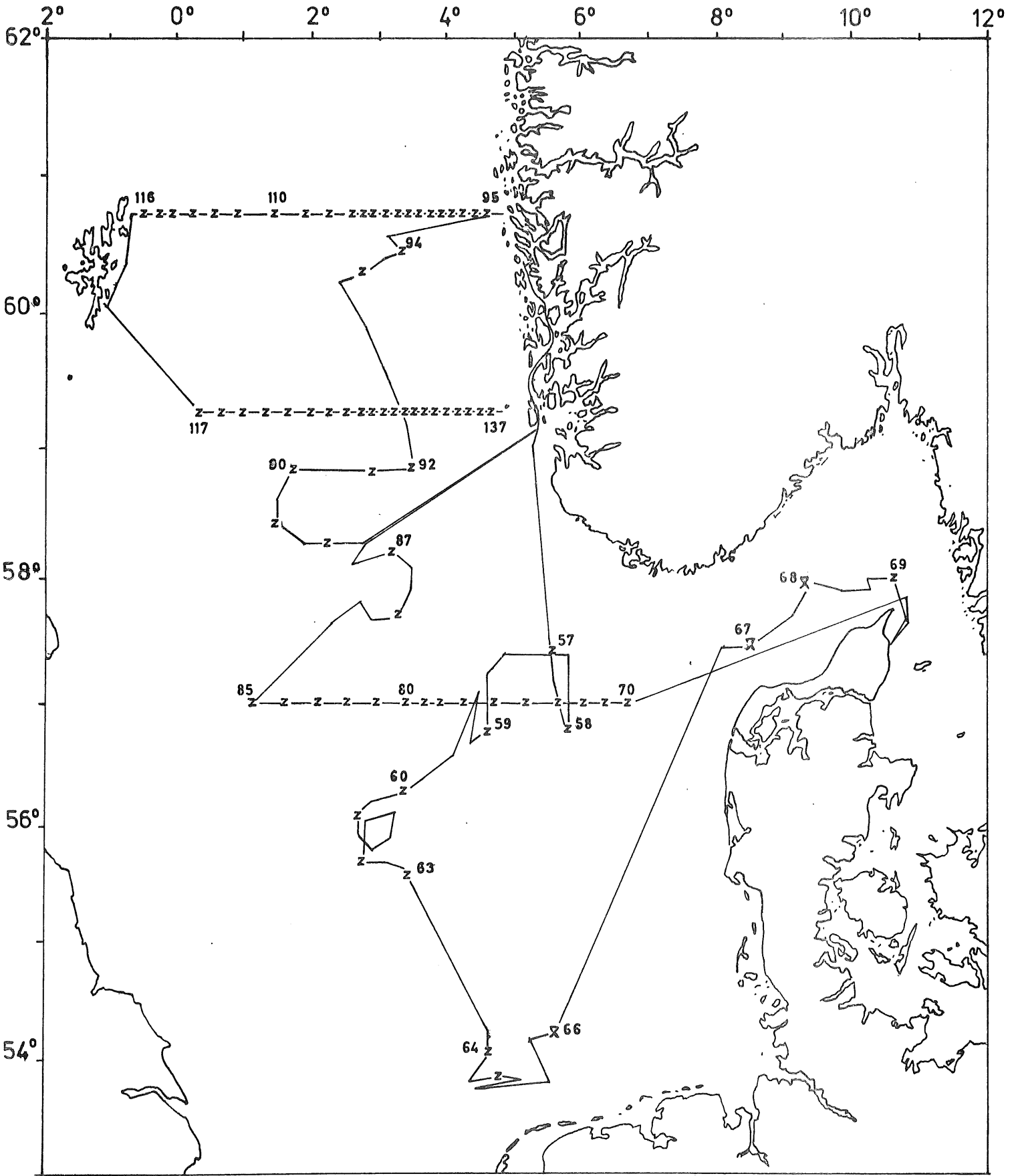

10 FEB.- 5 MAR. 1976

ST. NO. 57 - 137

„JOHAN HJORT“

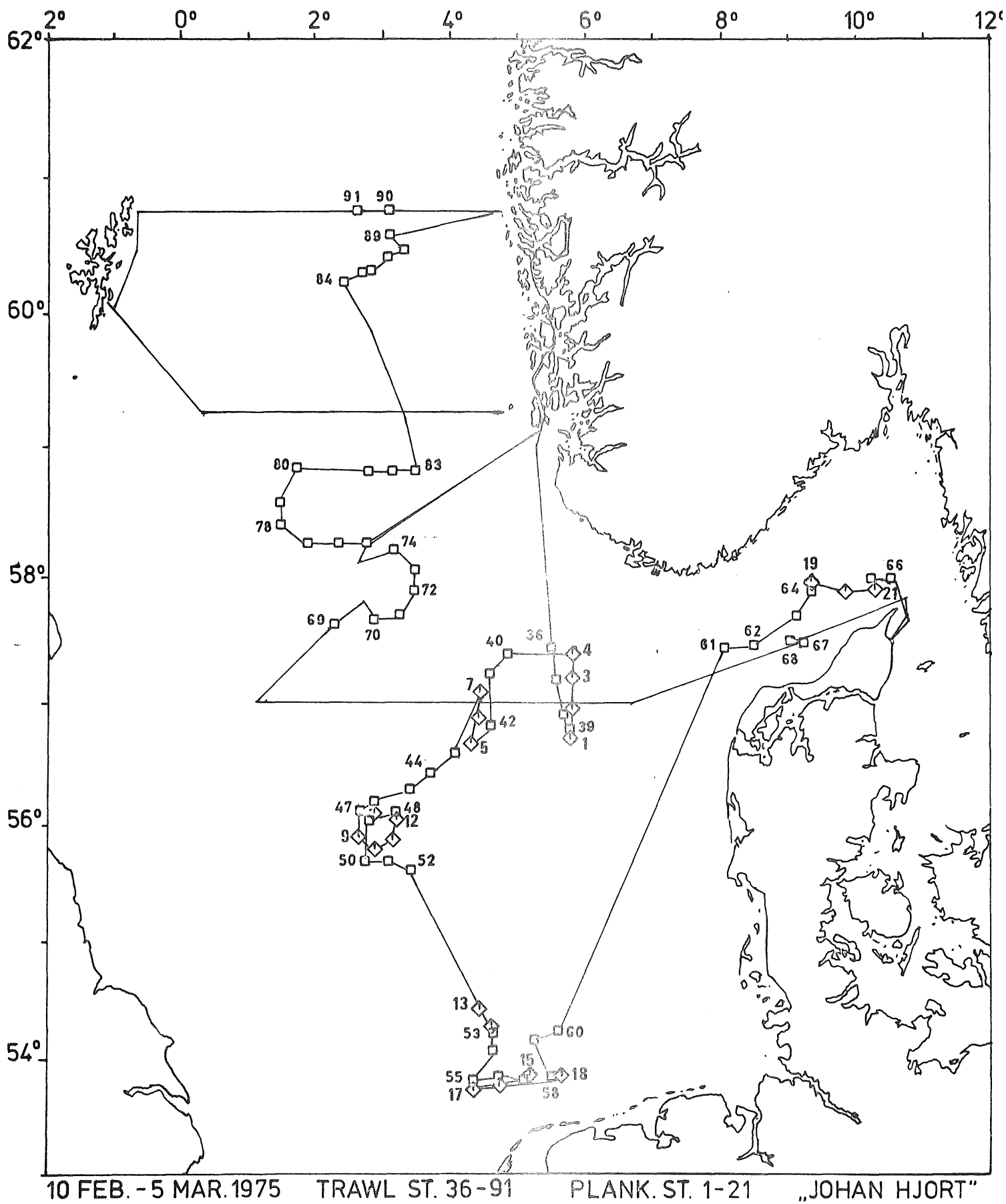

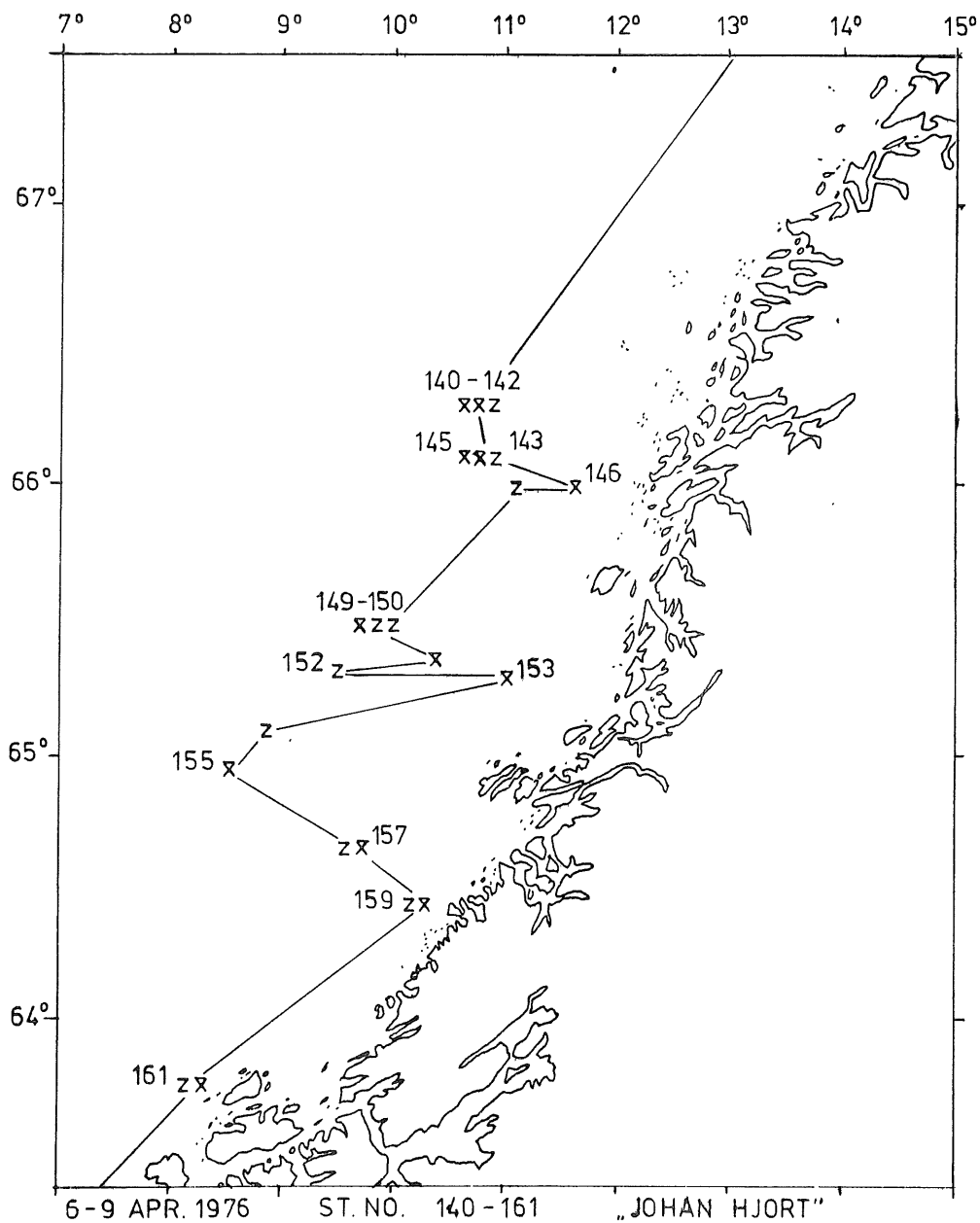
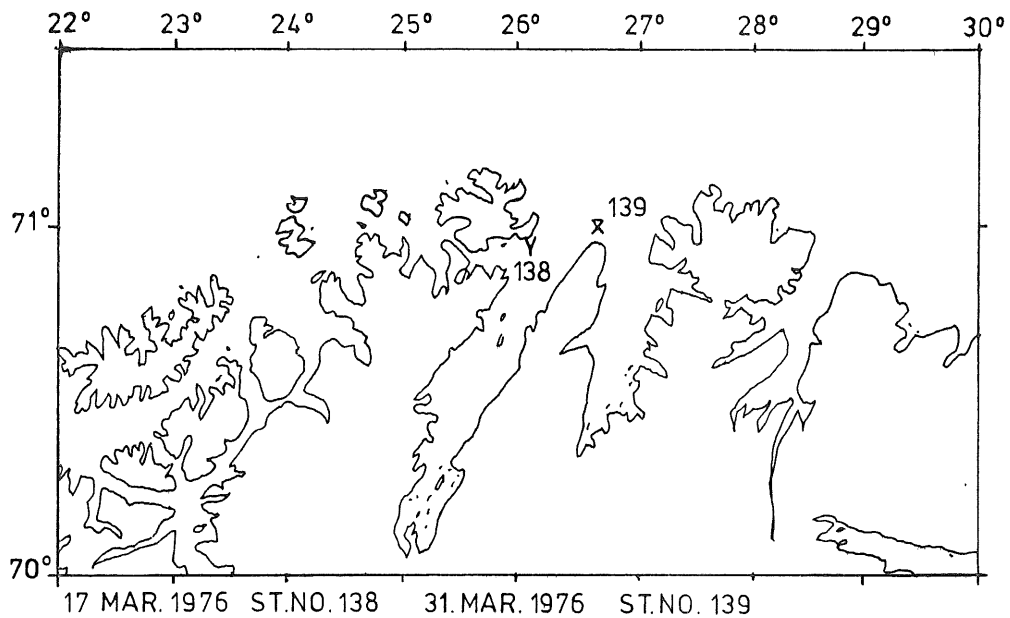

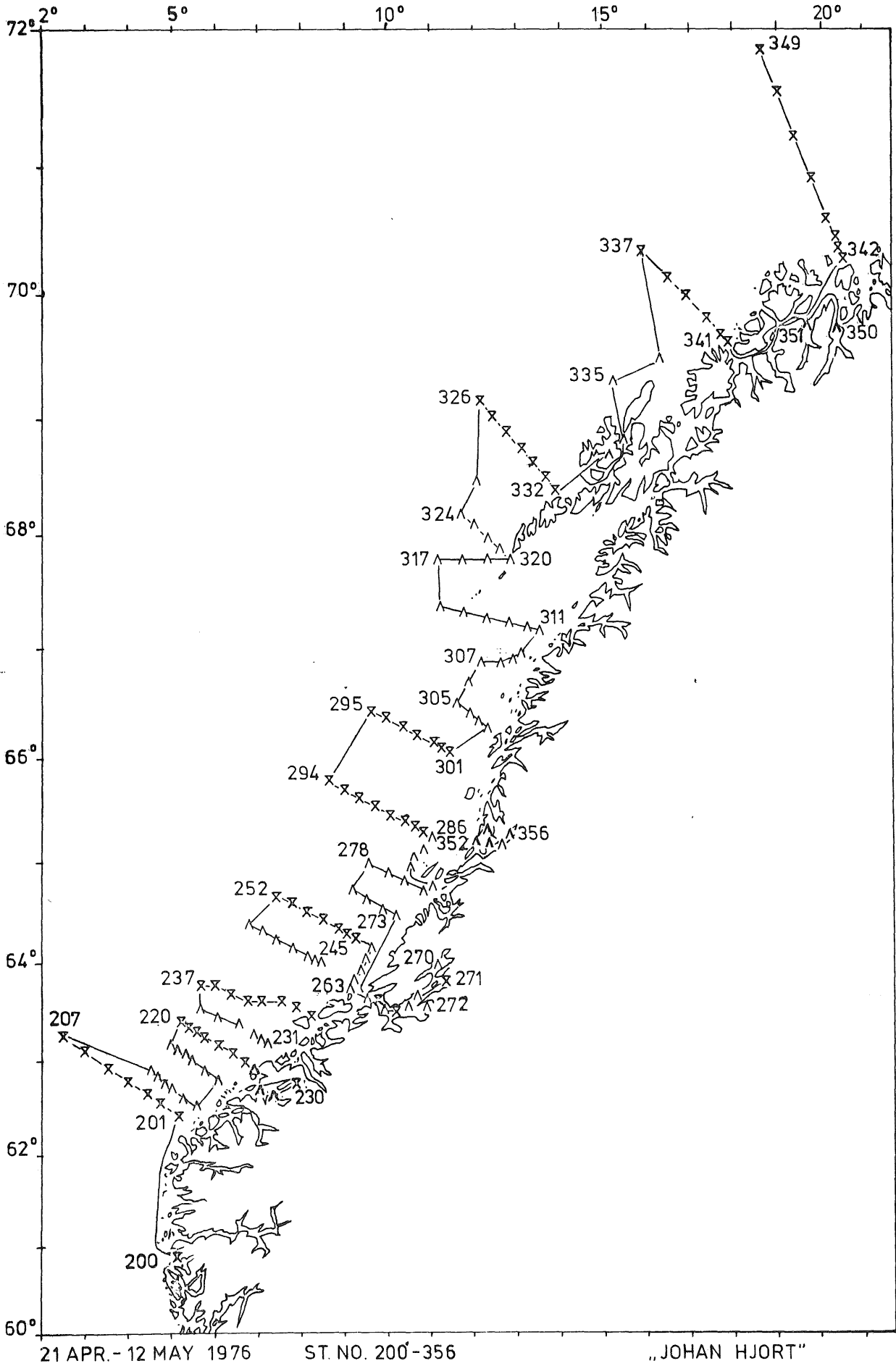

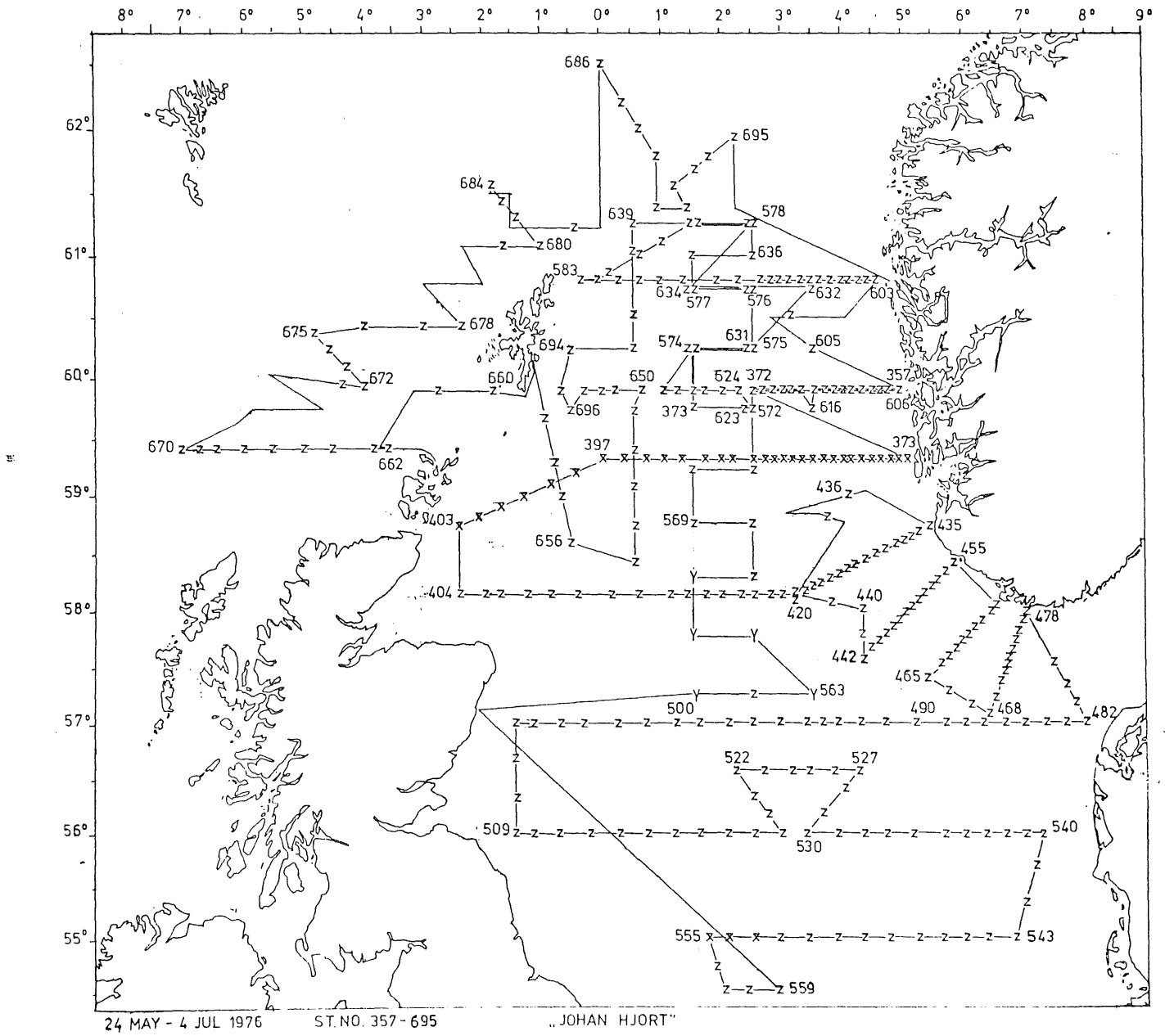

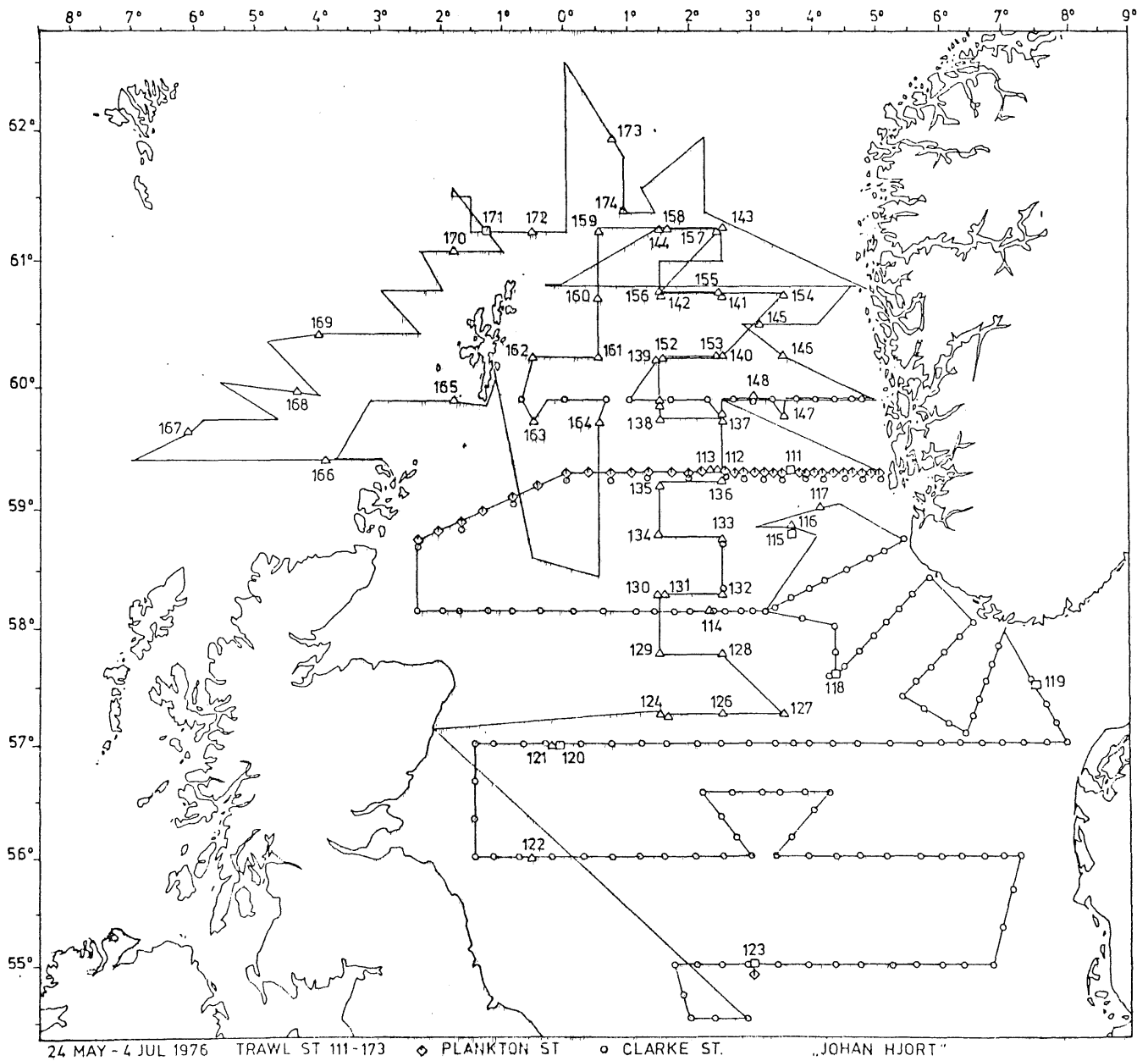

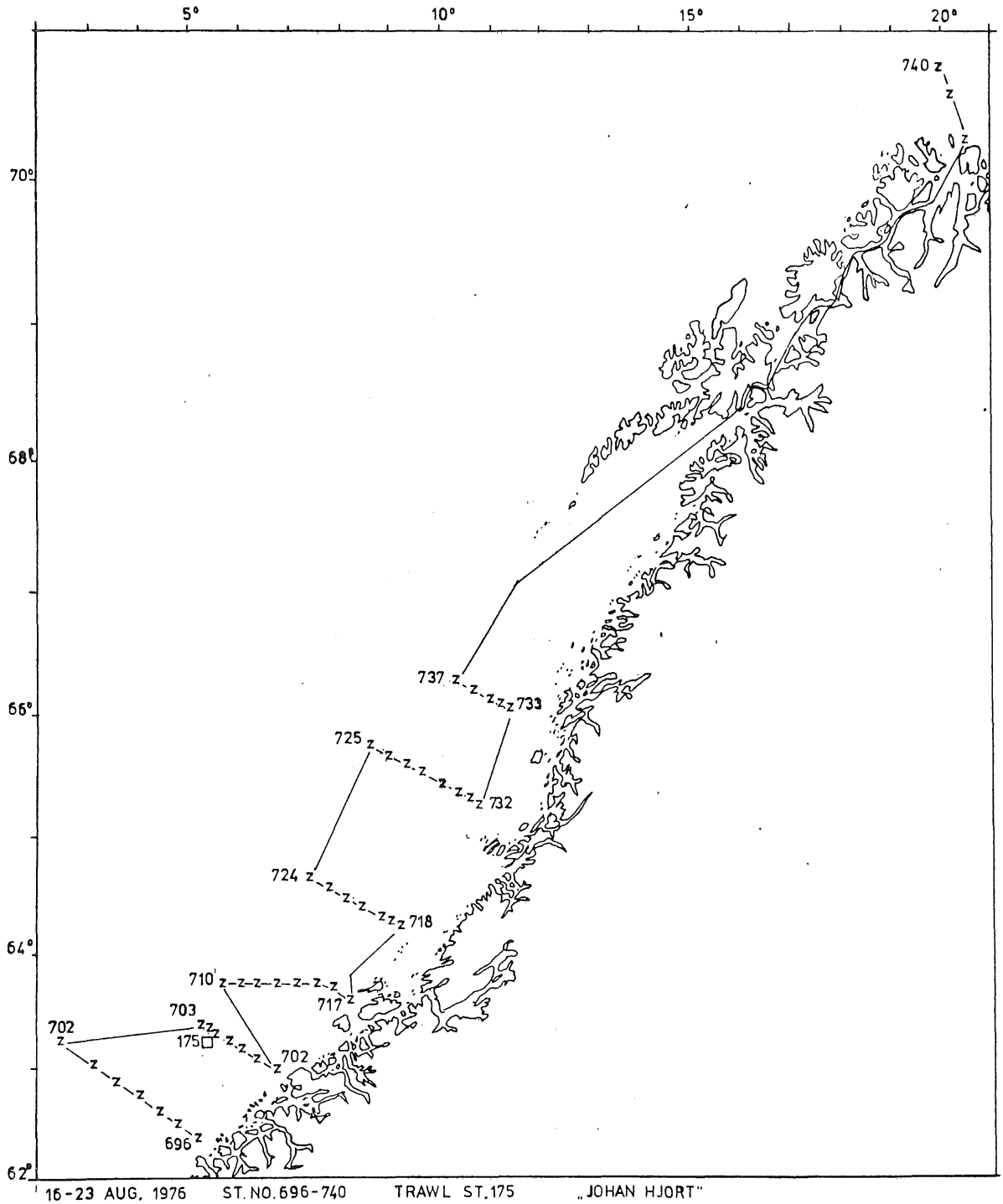

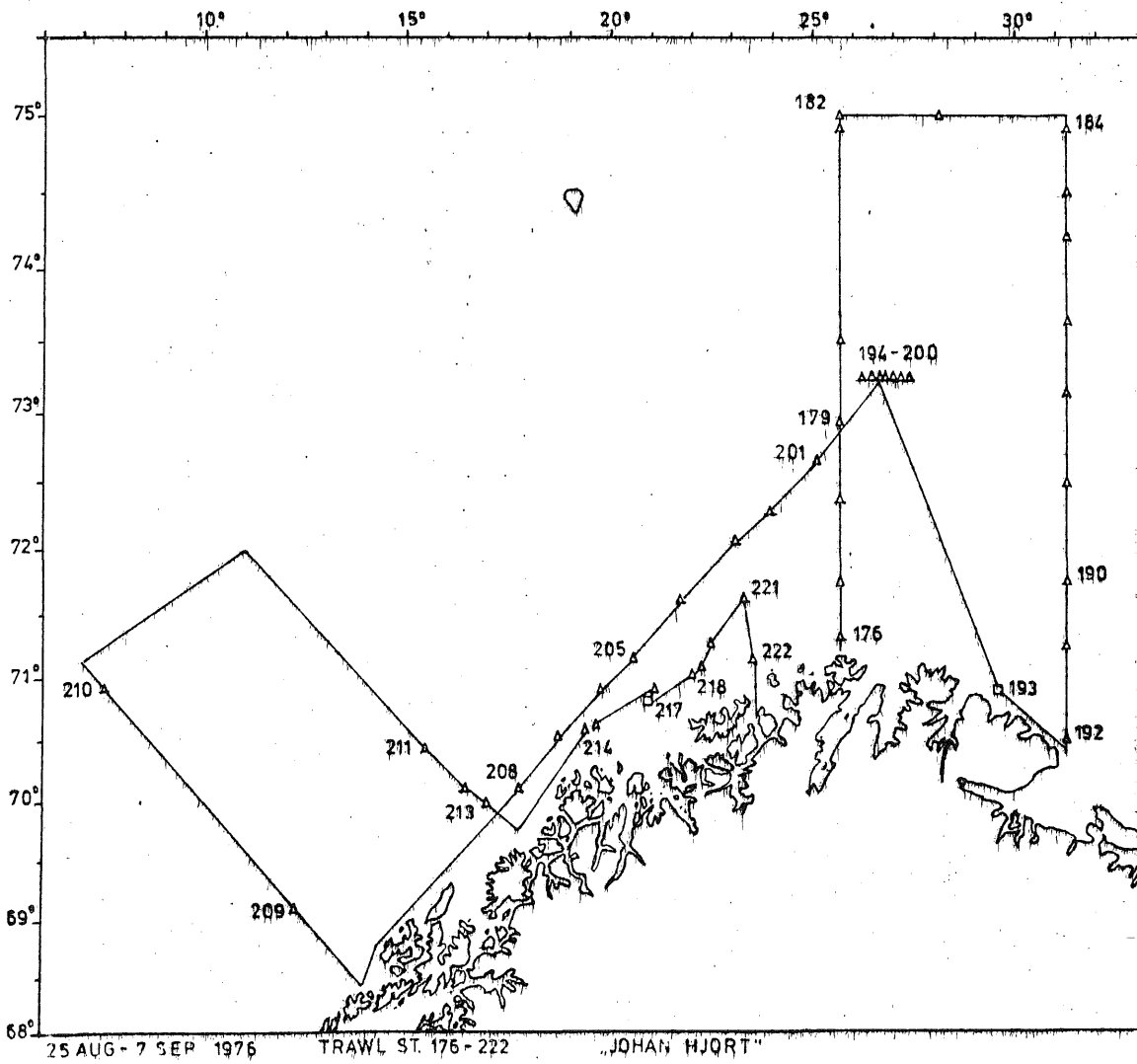
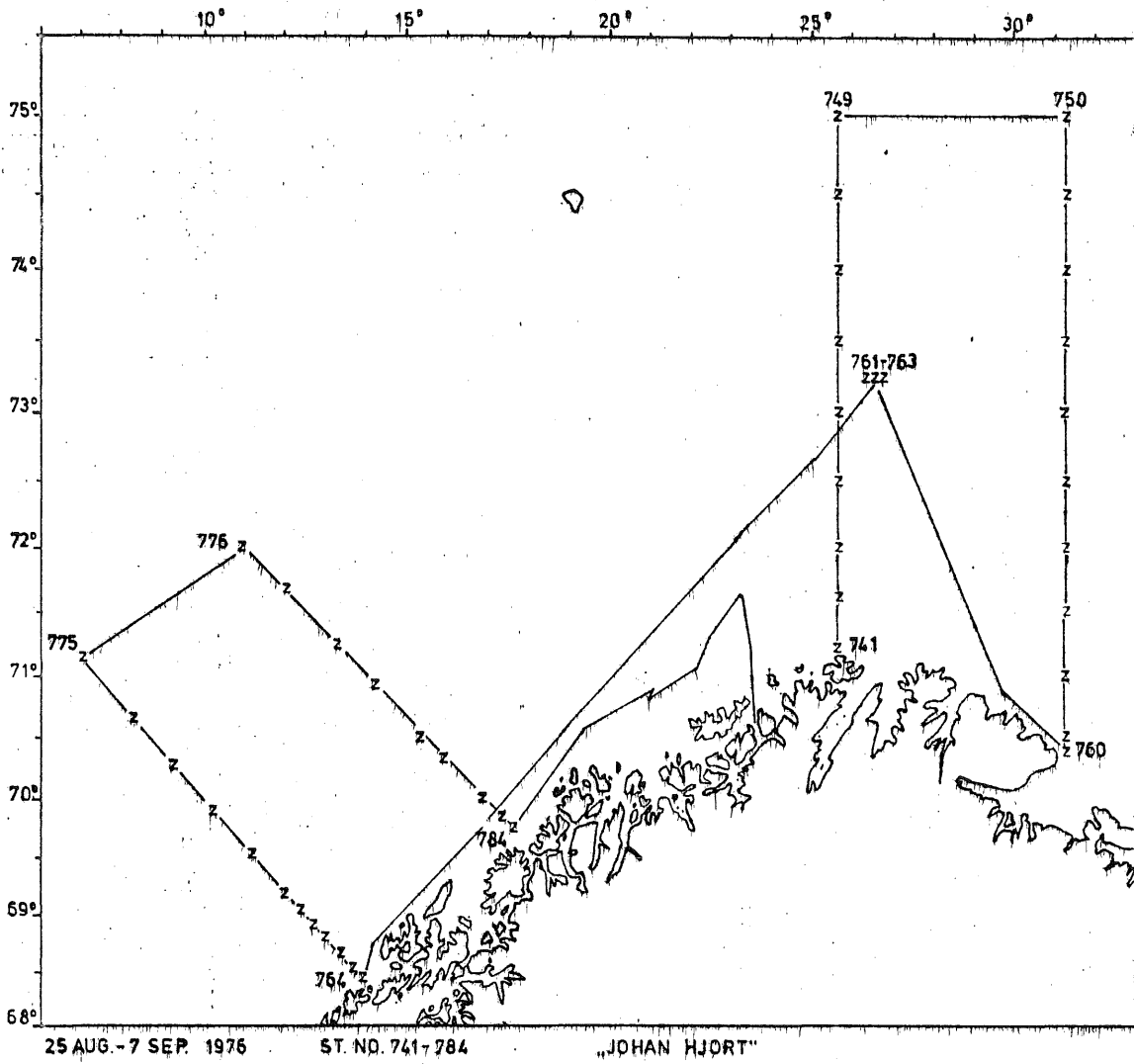



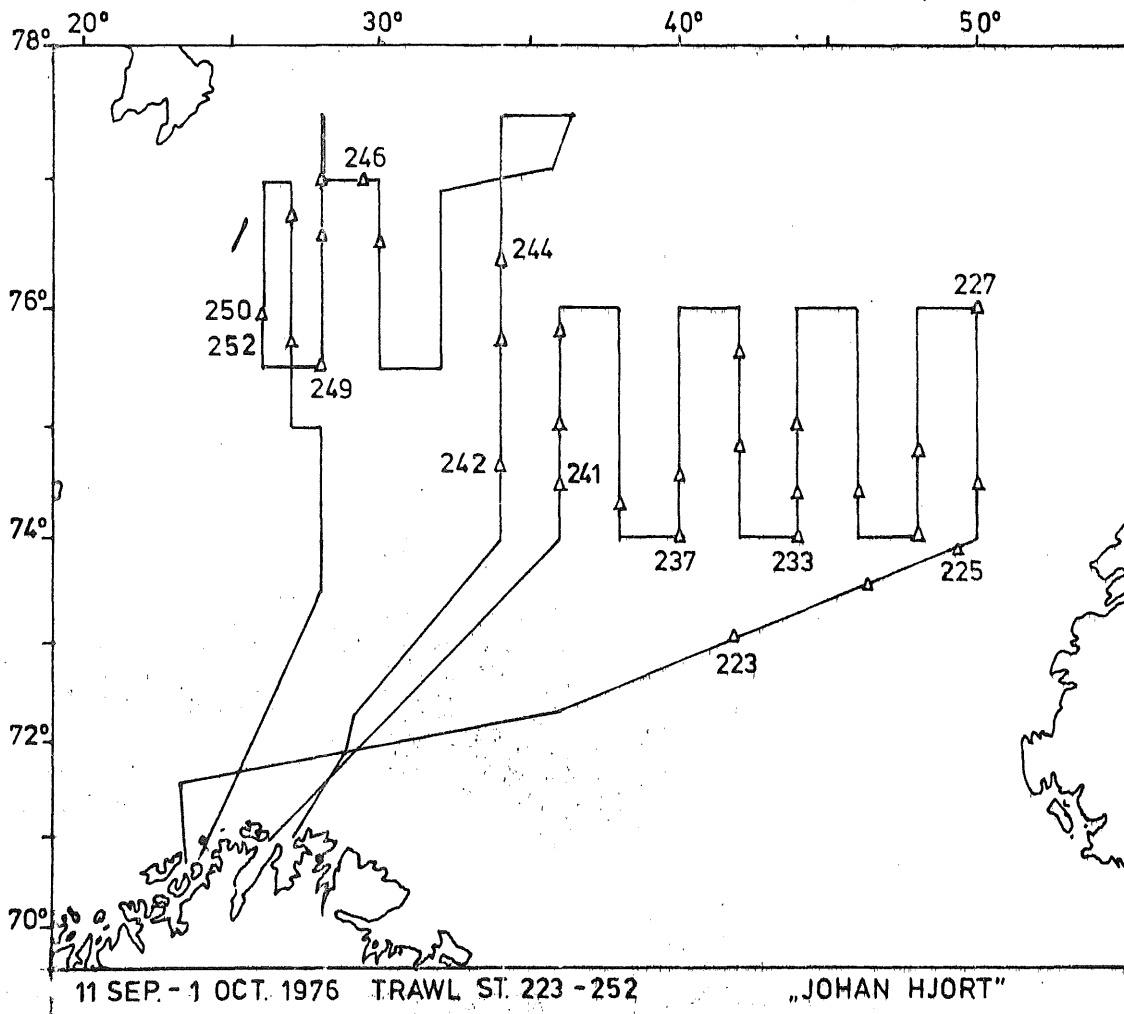
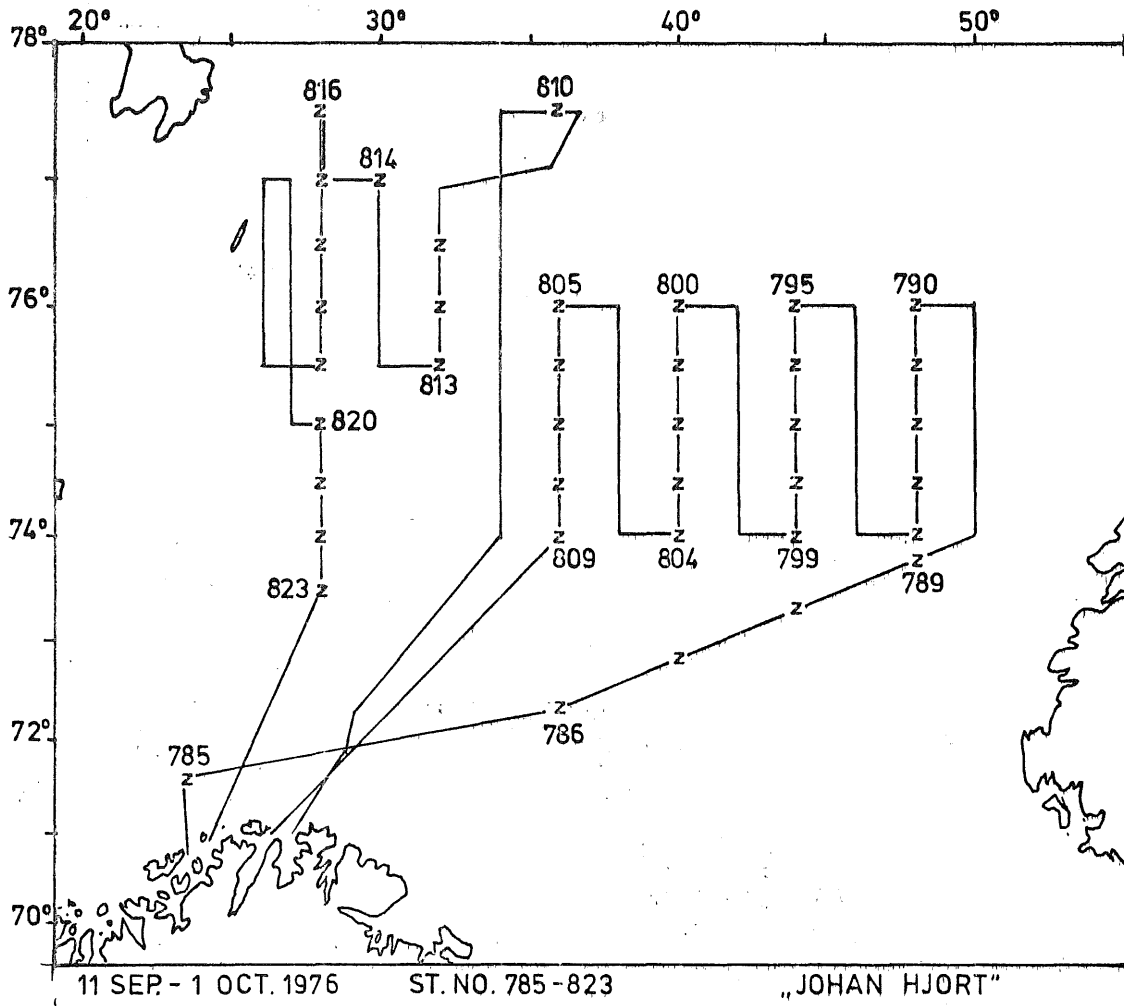

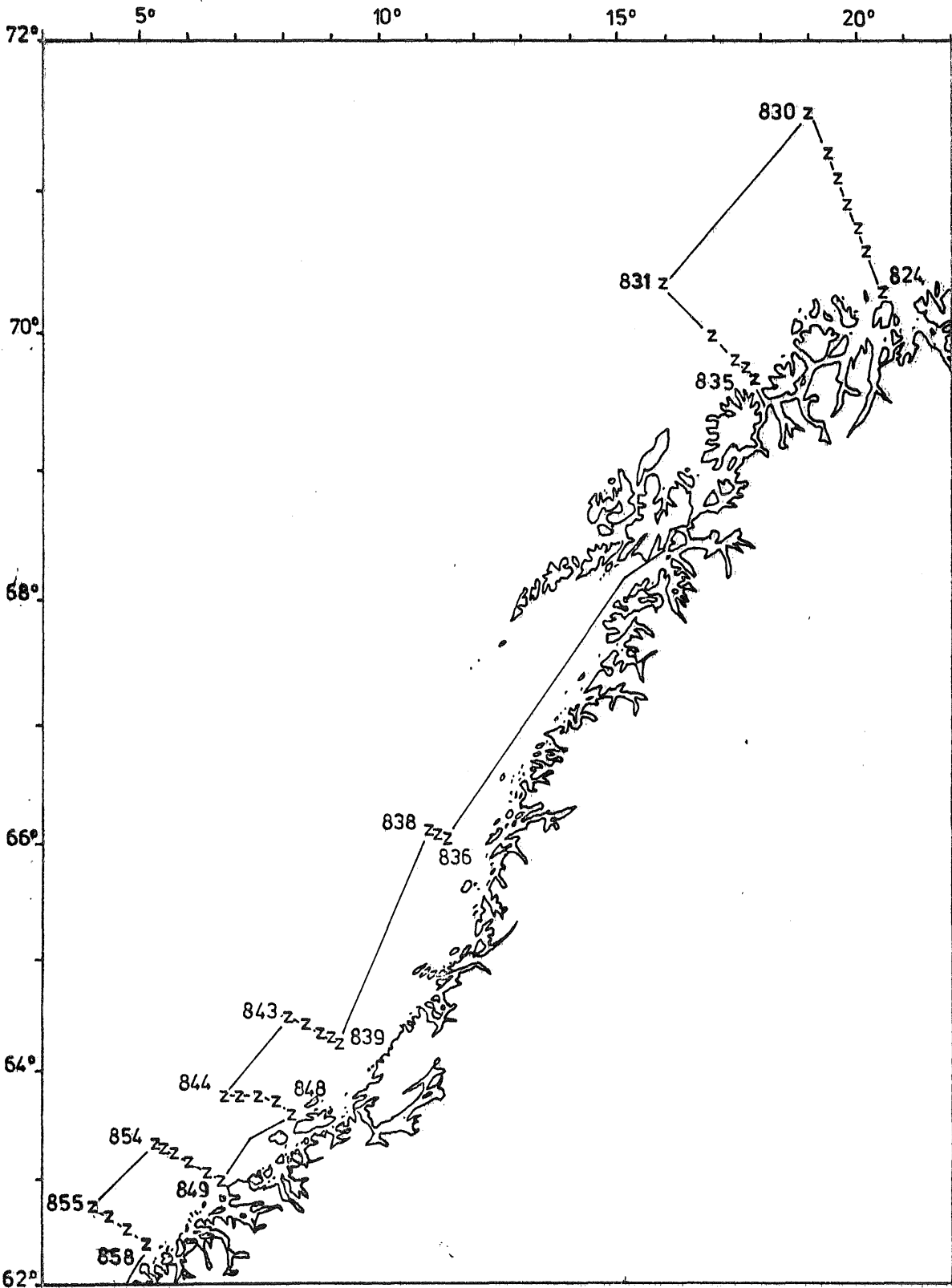

4-12 OCT. 1976

ST. NO. 824-858

"JOHAN HJORT"

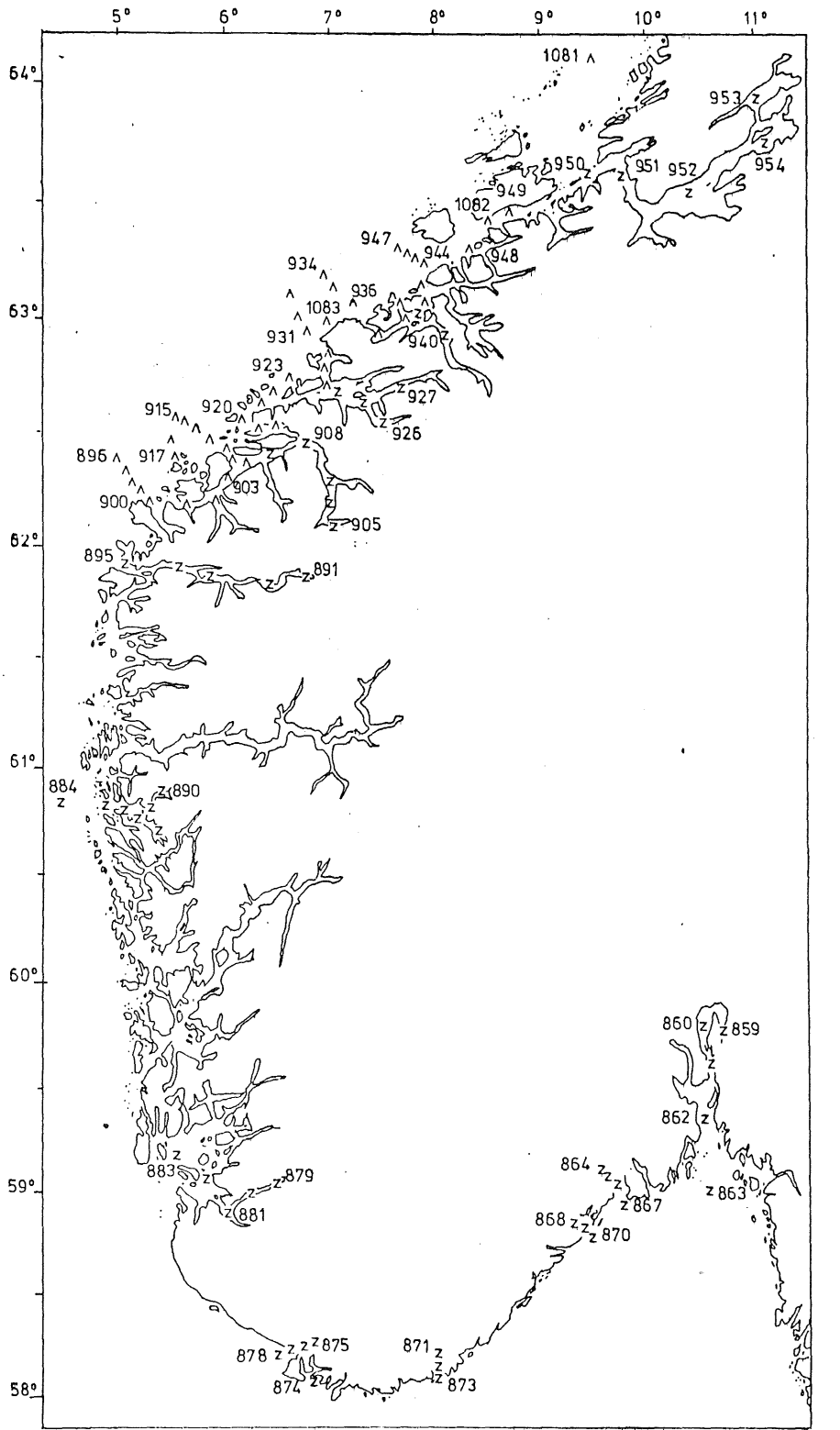

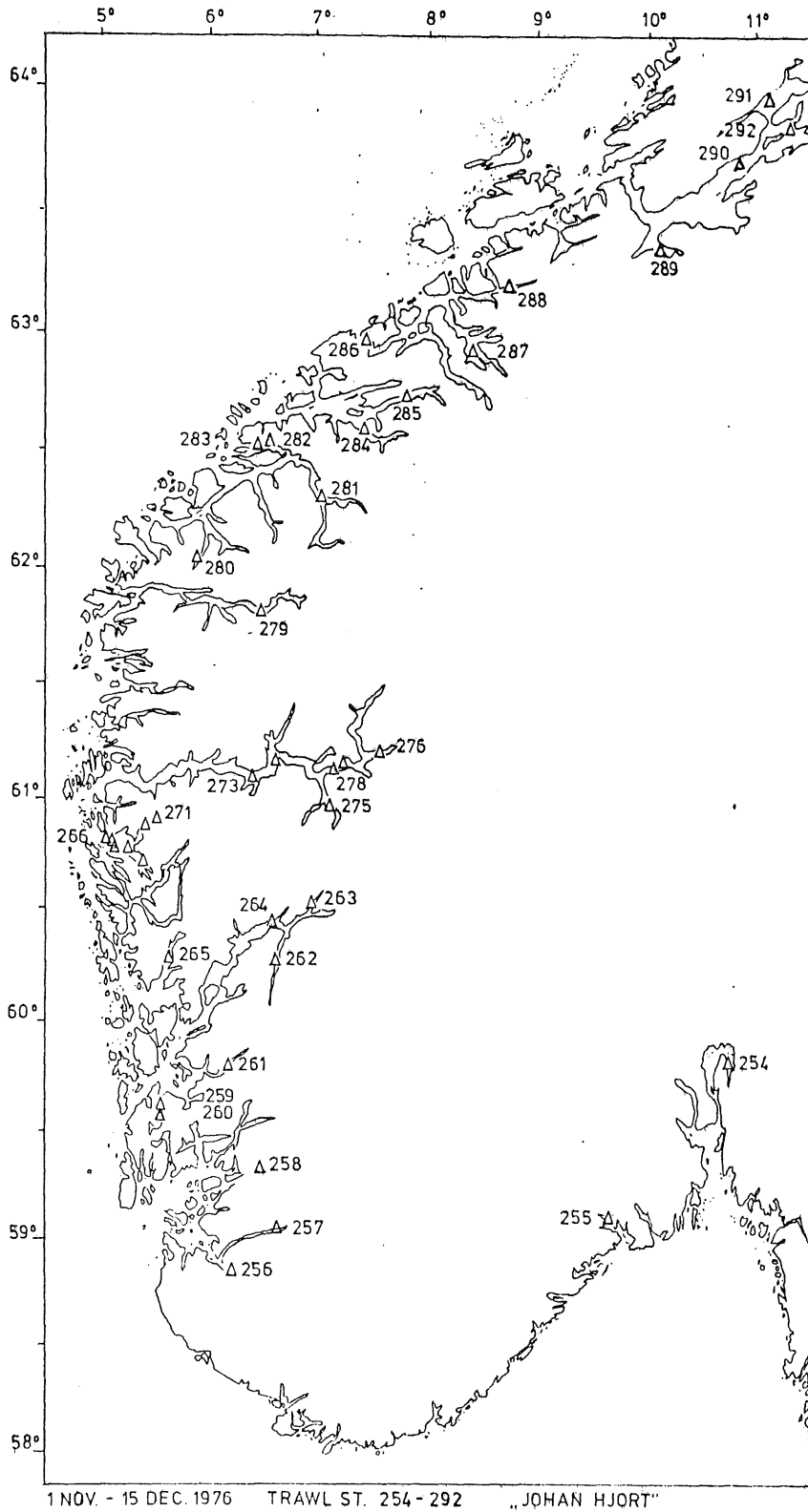

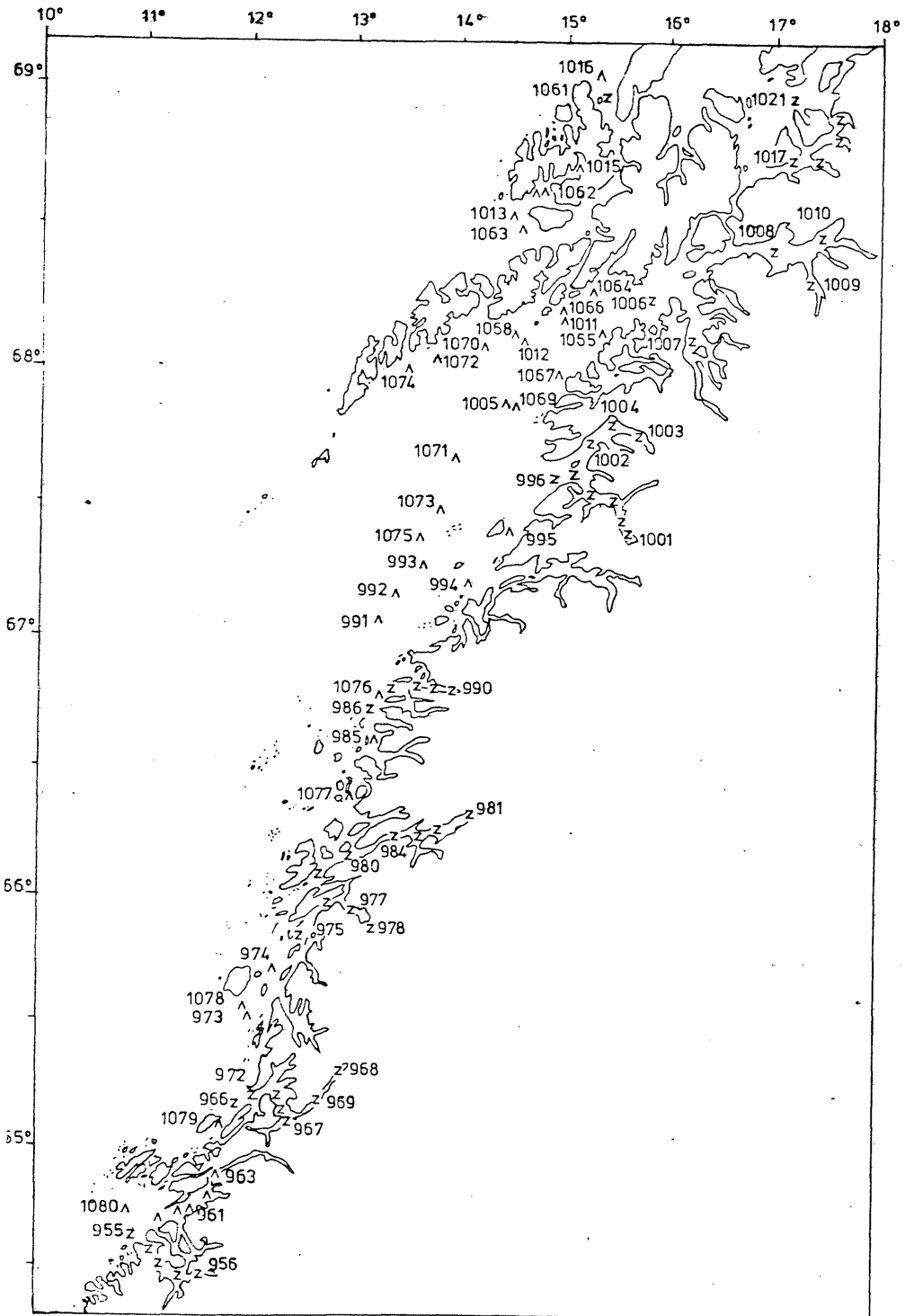

1 NOV. - 15 DEC 1976 ST. NO. 955 - 1021 1061 - 1080 A SURF. OBS. + GULF „JOHAN HJORT“

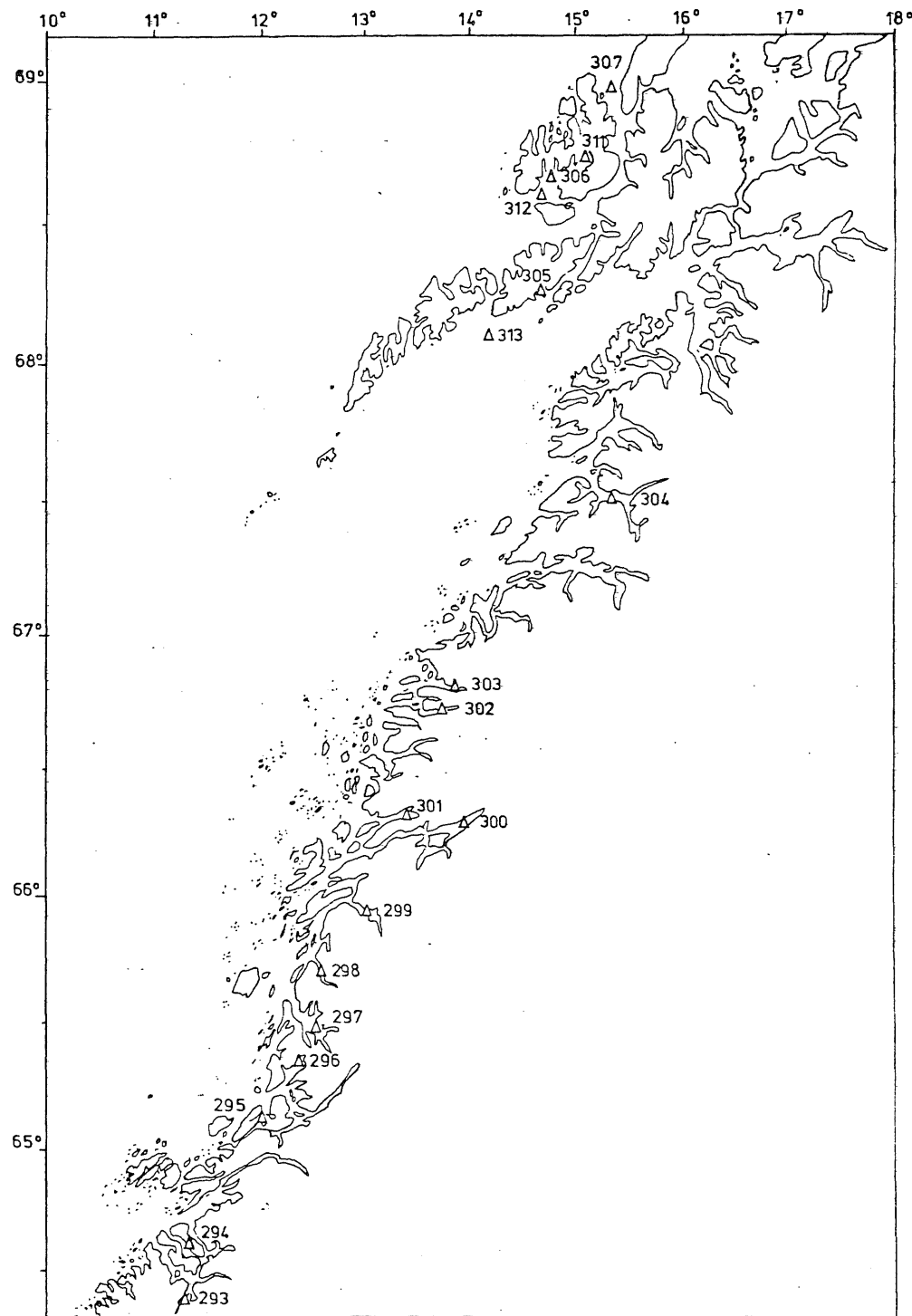

1 NOV. - 15 DEC. 1976 TRAWL ST. 293-307 311-313 „JOHAN HJORT“

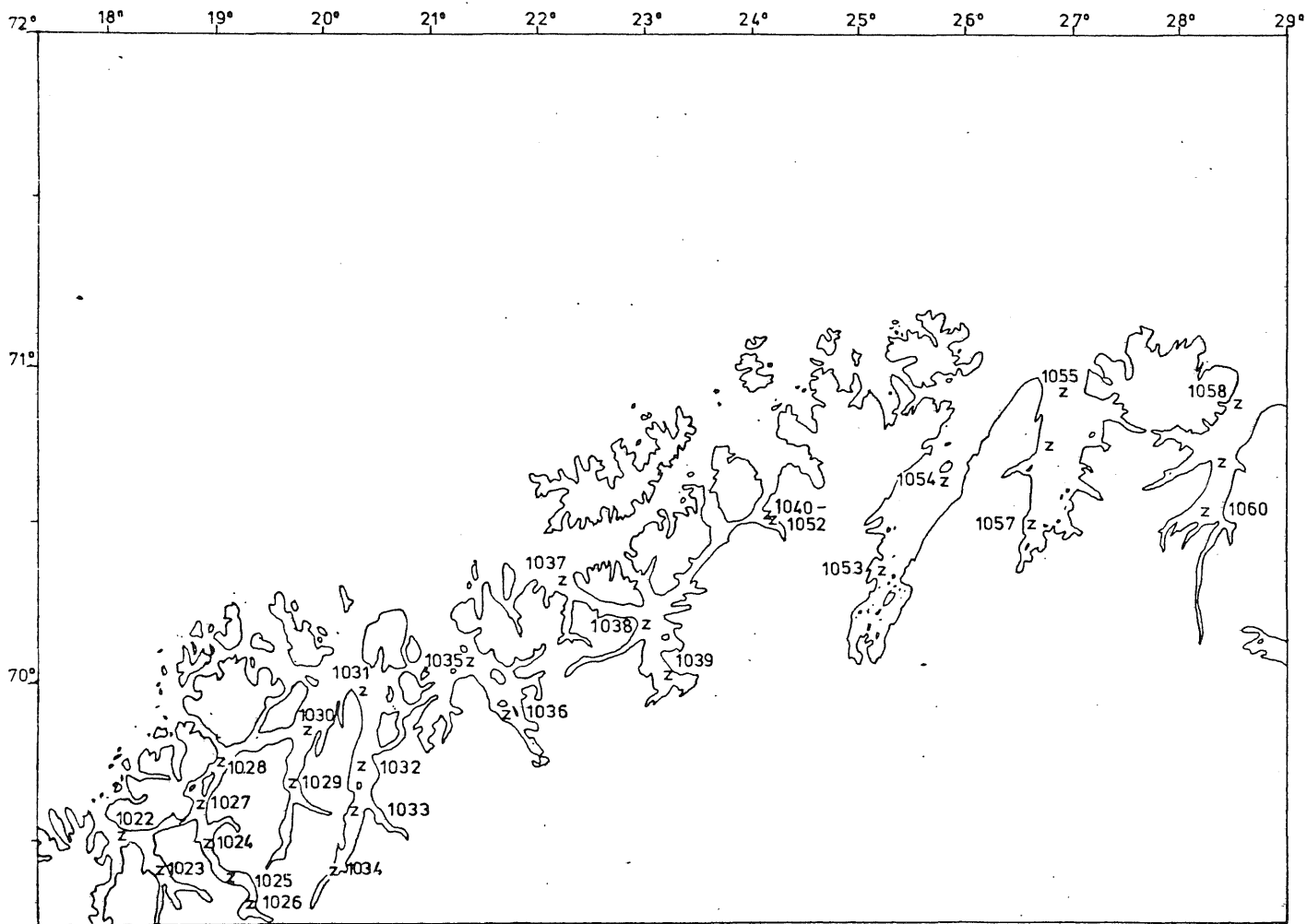

1 NOV. - 15 DEC. 1976 ST. NO. 1022 - 1060 „JOHAN HJORT“

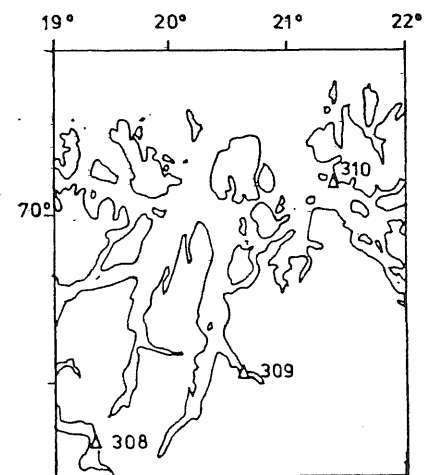

1 NOV. - 15 DEC. 1976 TRAWL ST. 308-310 „JOHAN HJORT“

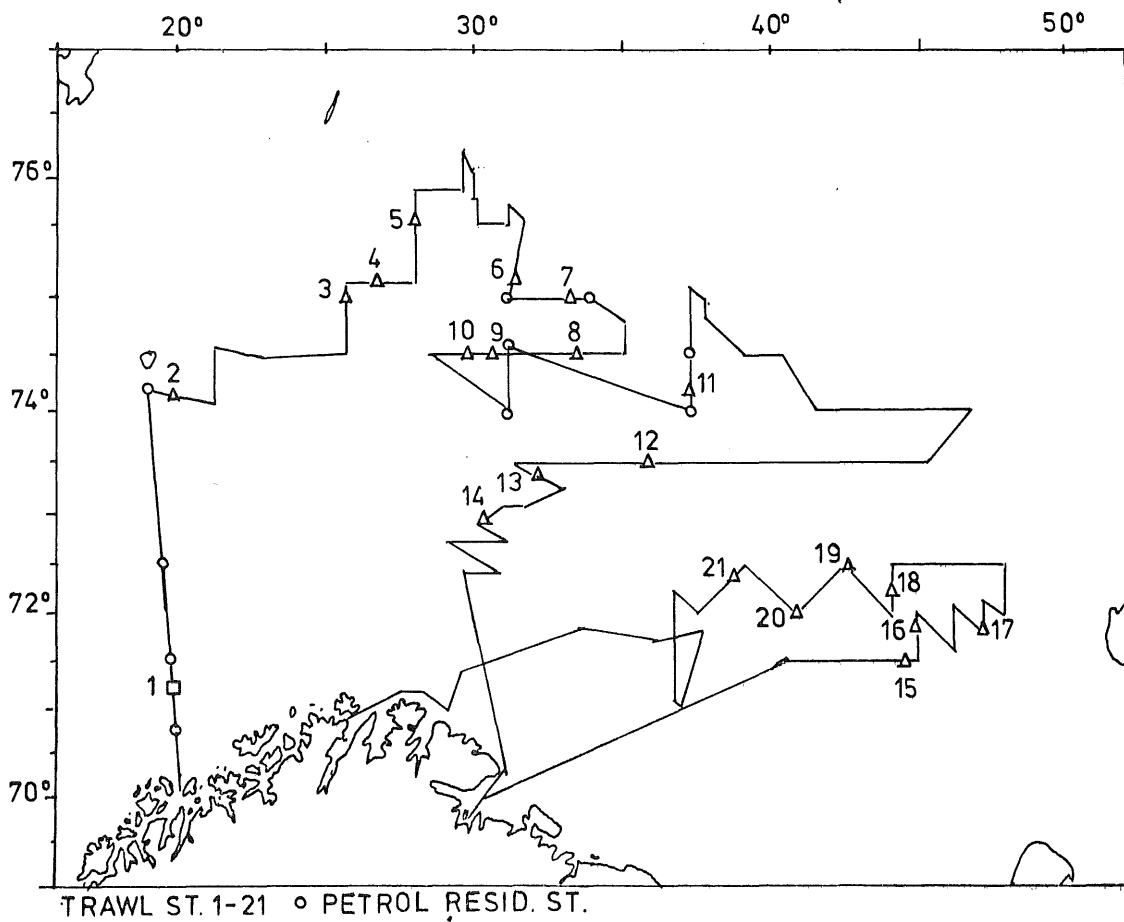
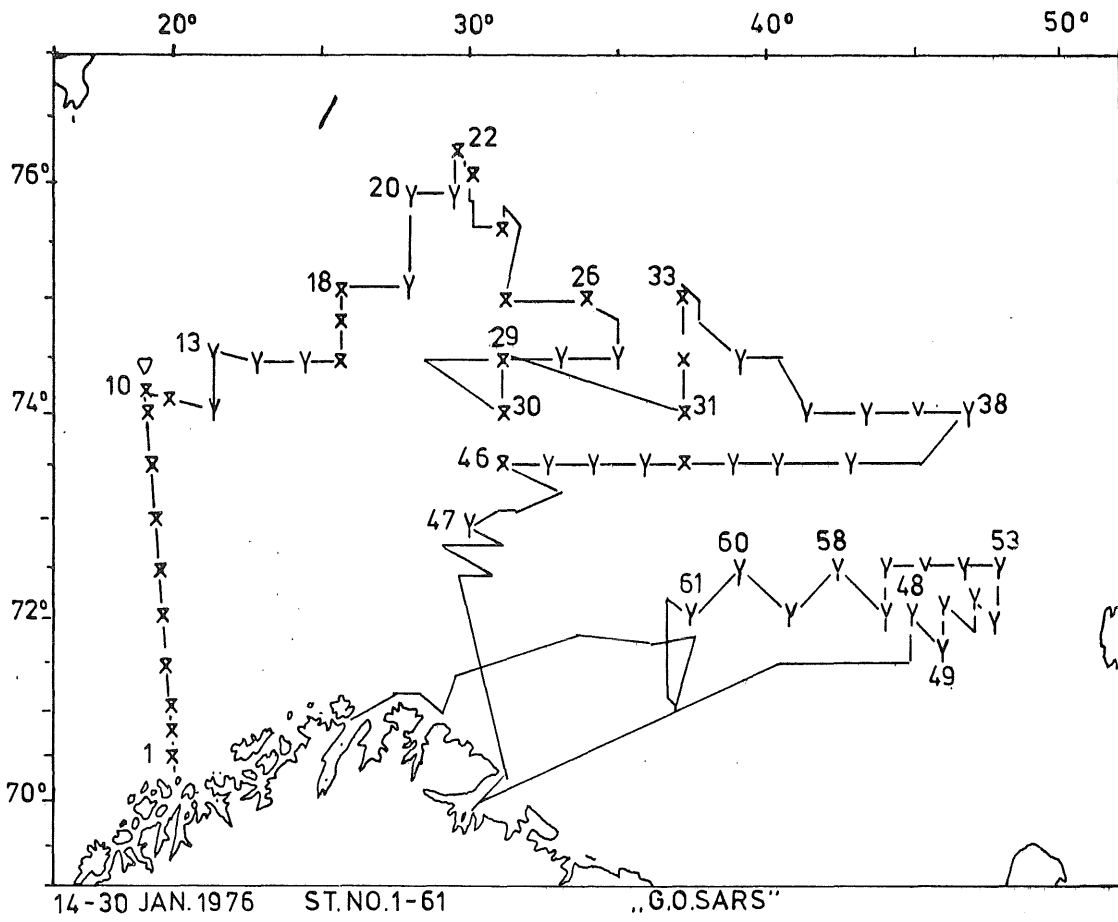

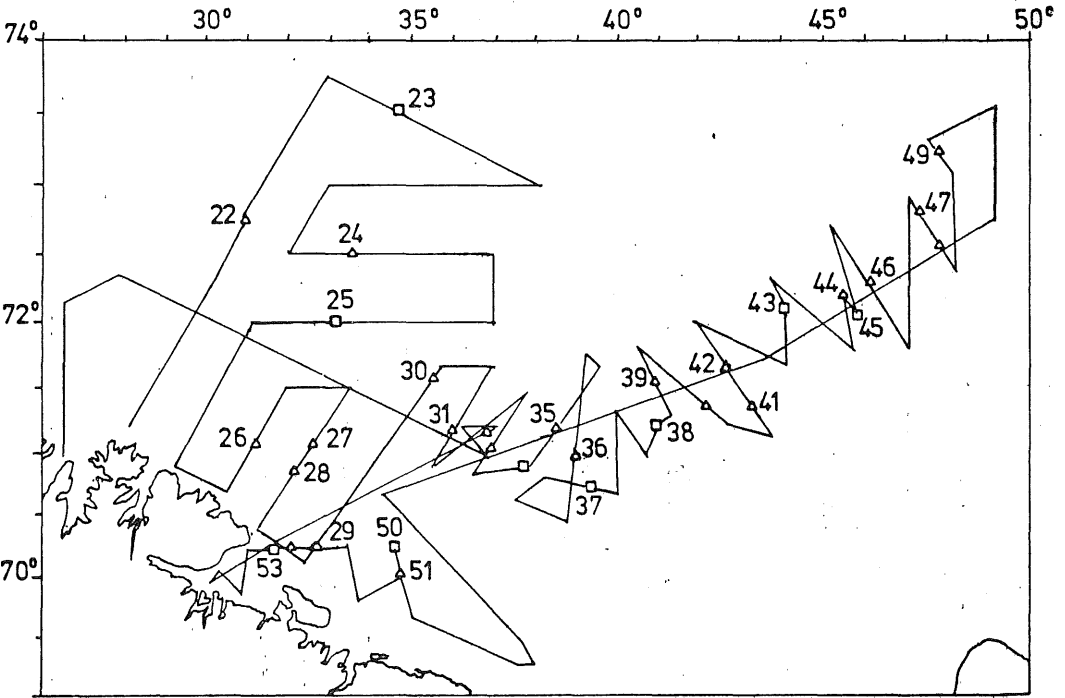
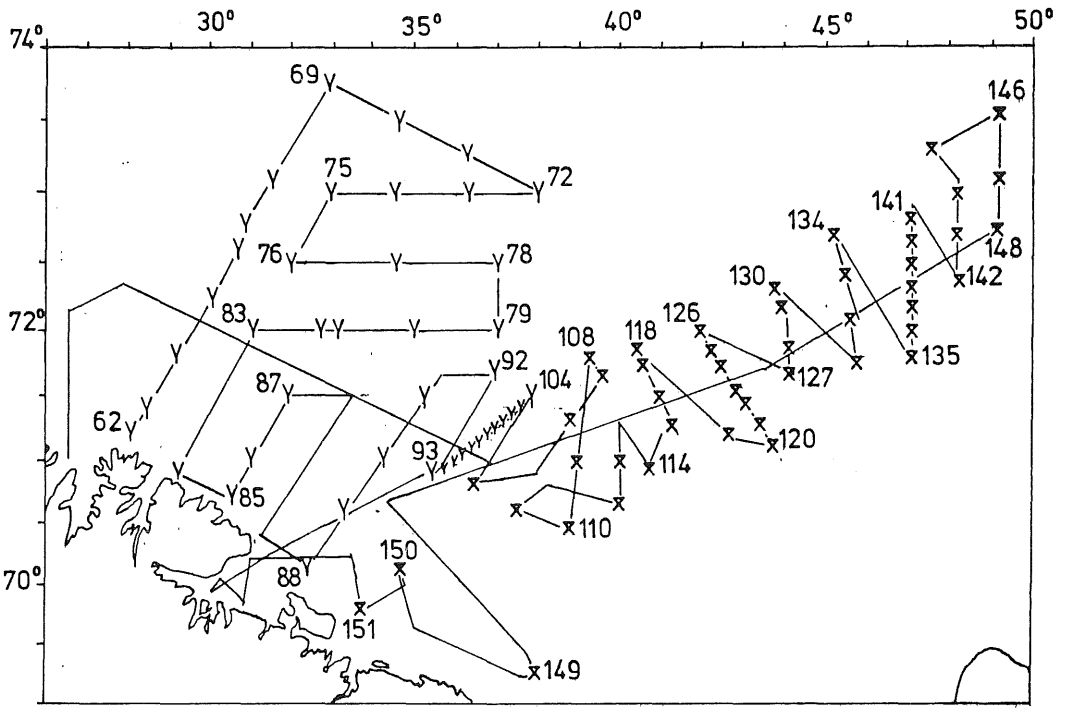

2-27 FEB. 1976 ST. NO. 62-151 TRAWL ST. 22-53 "G.O. SARS"



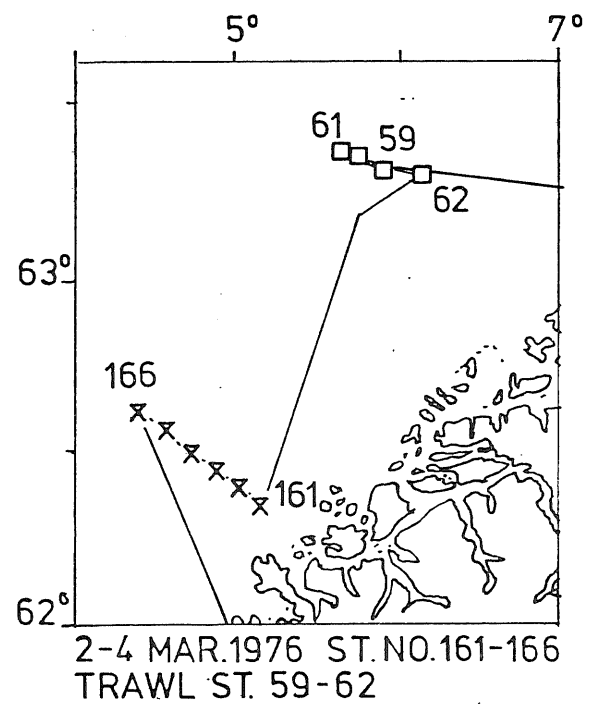
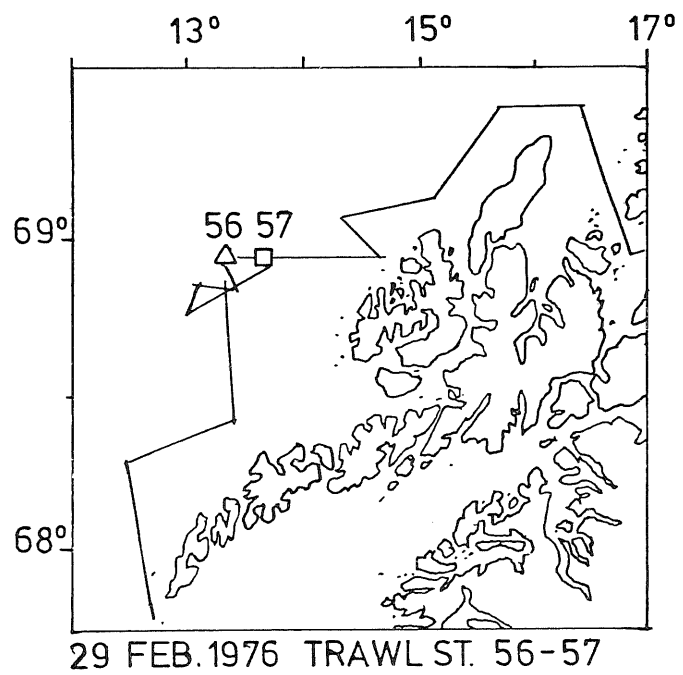
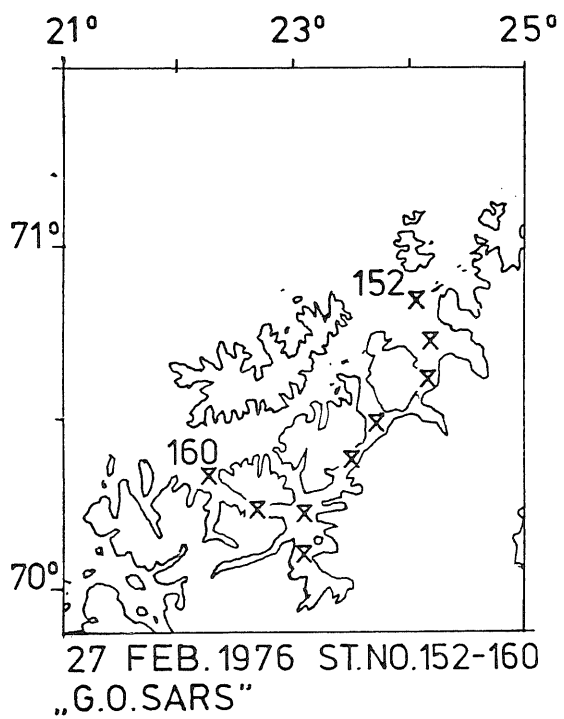

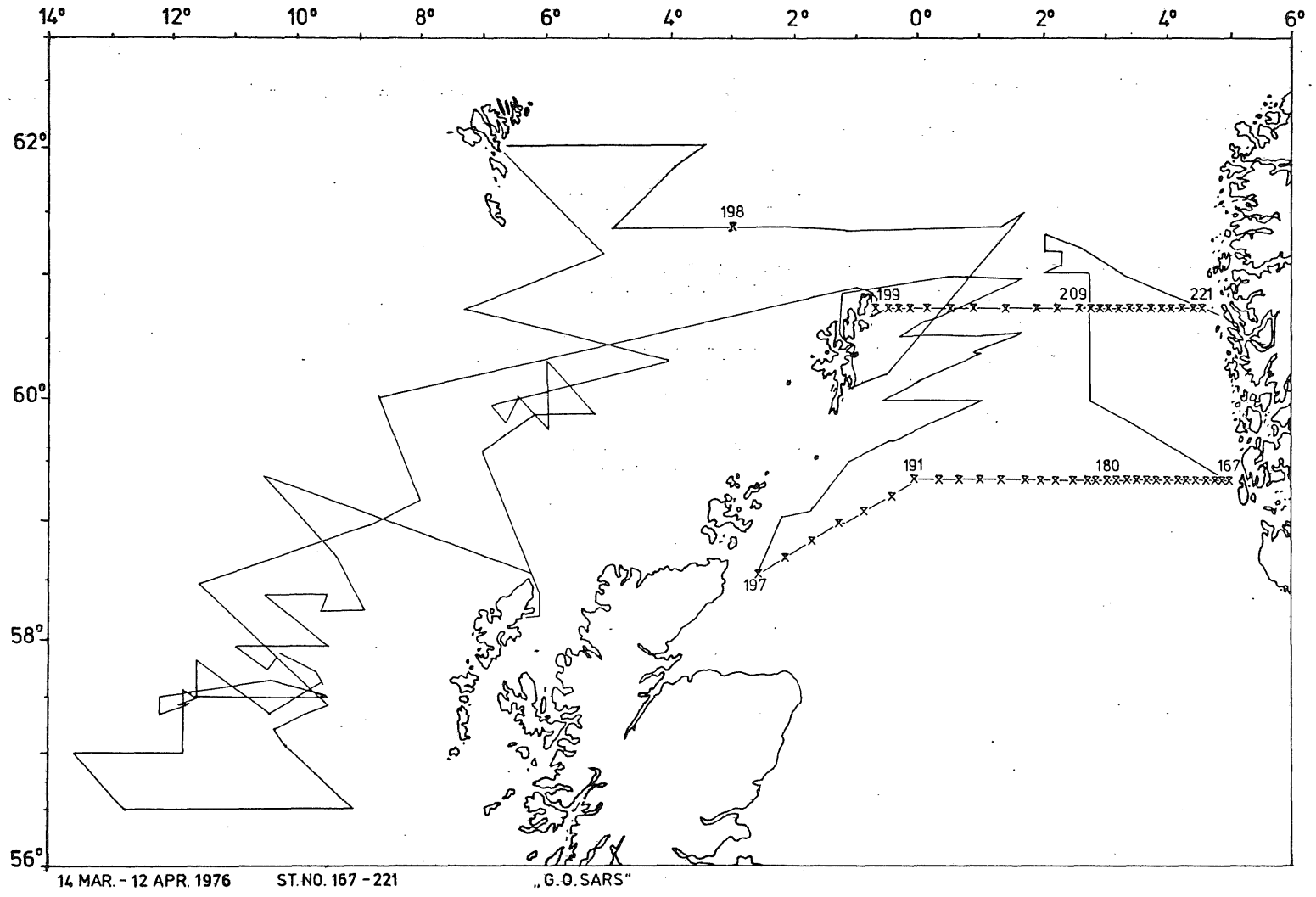

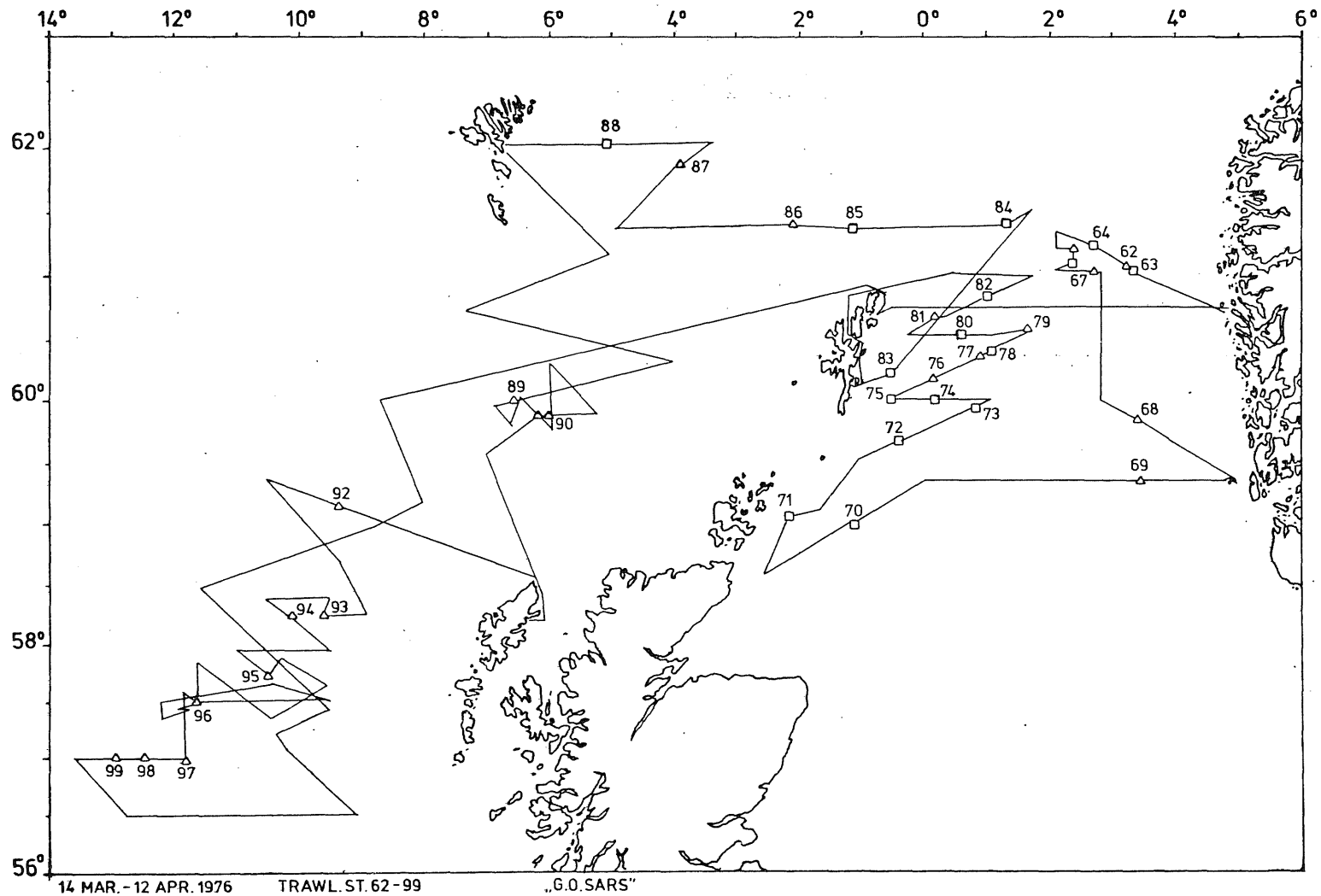

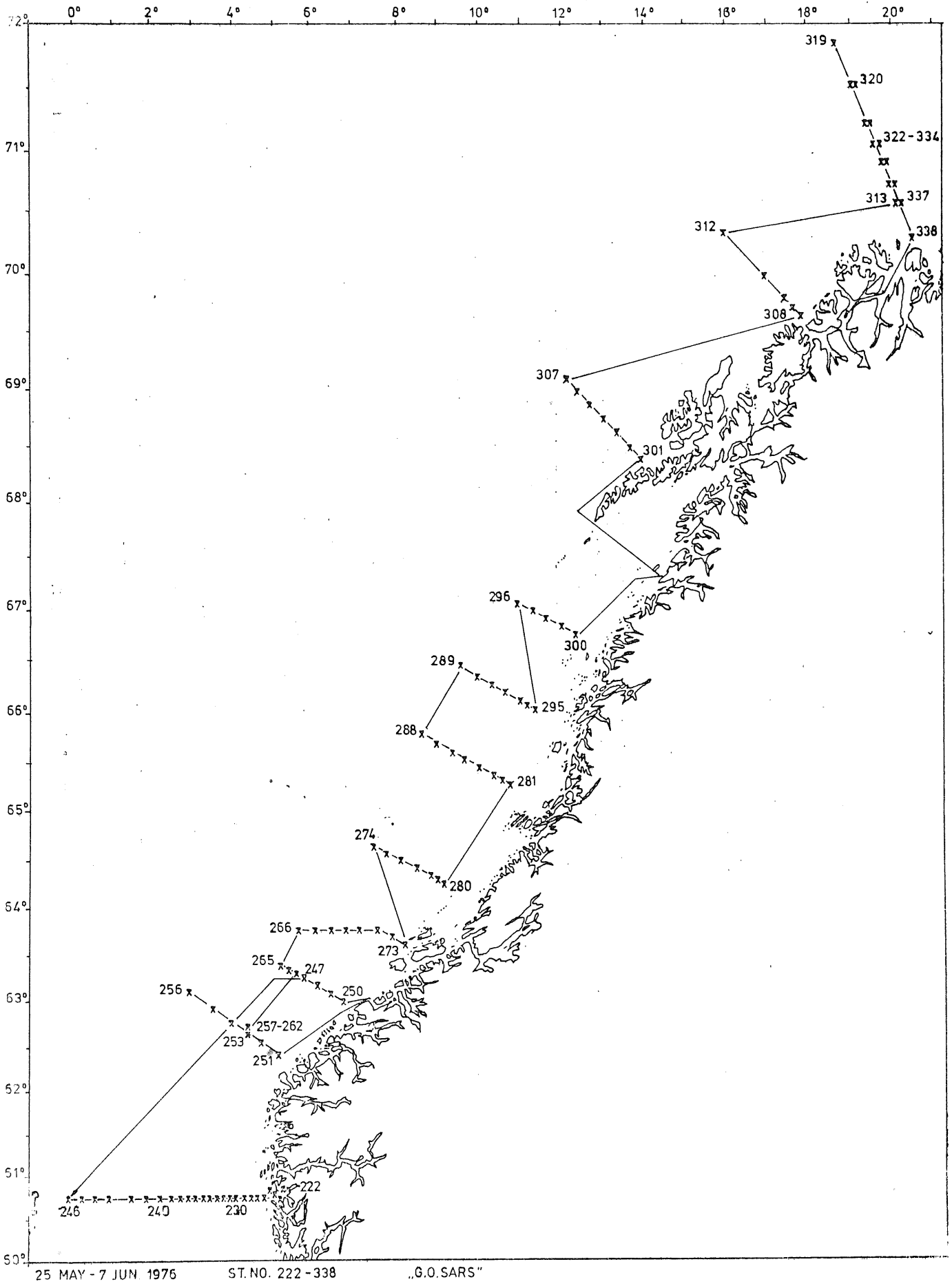

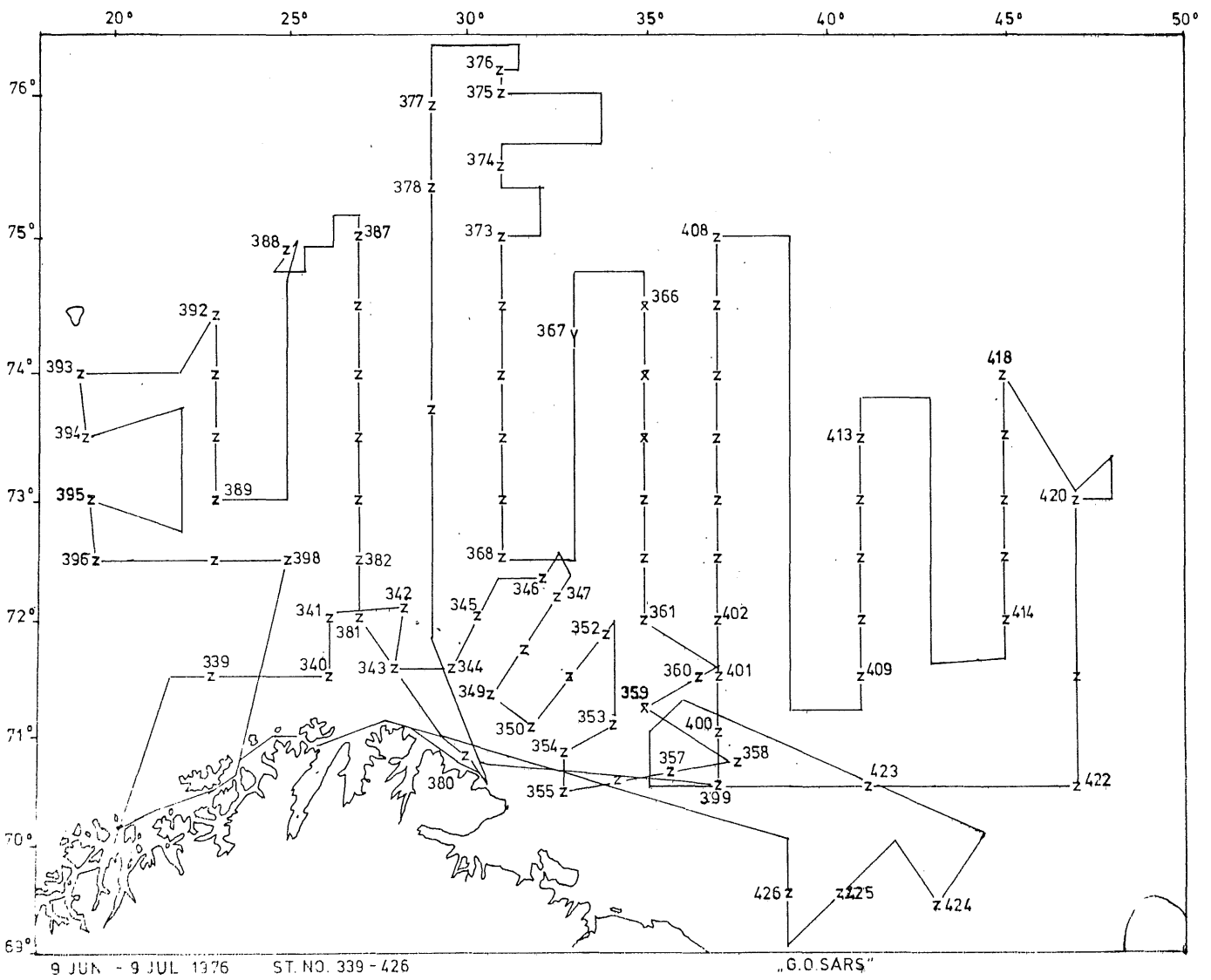

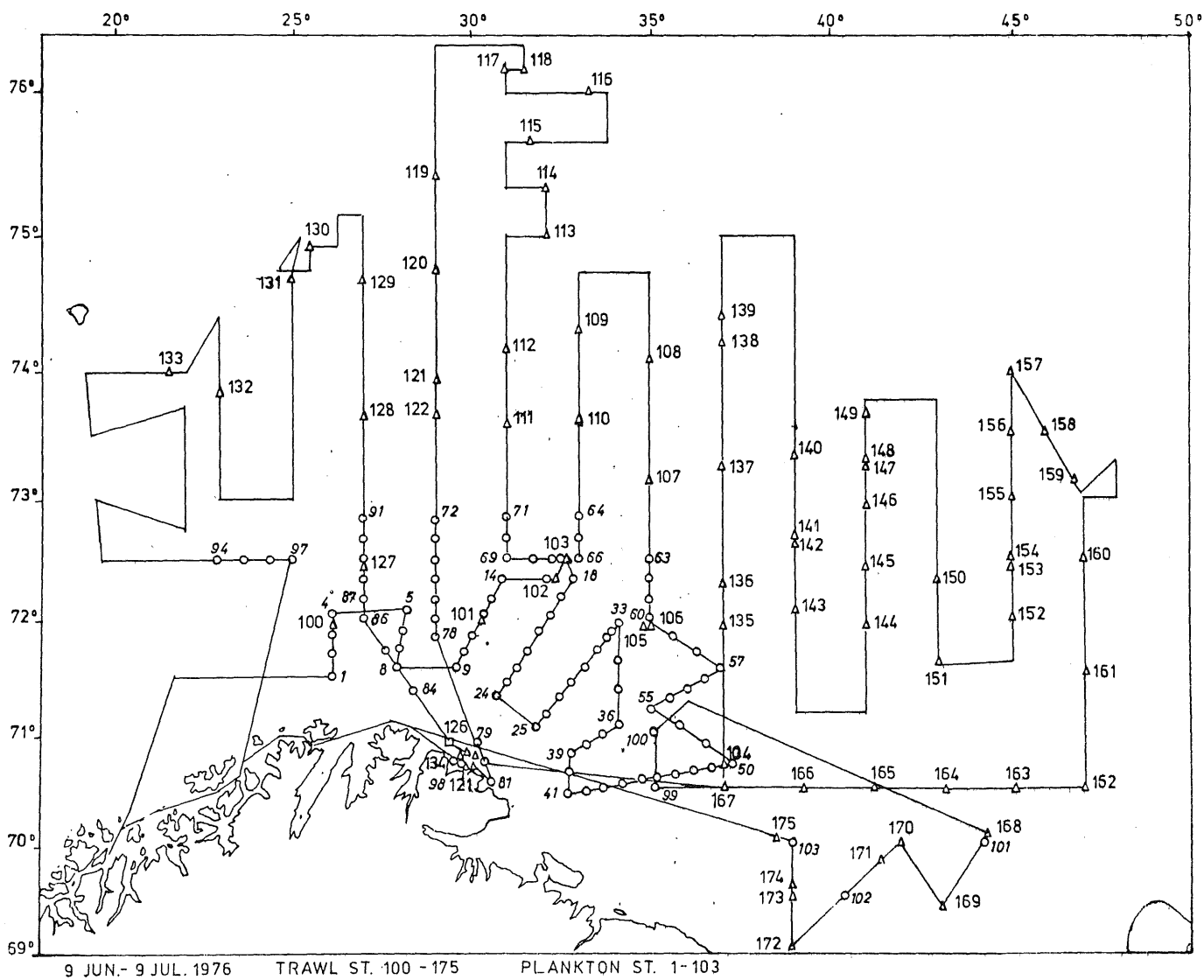

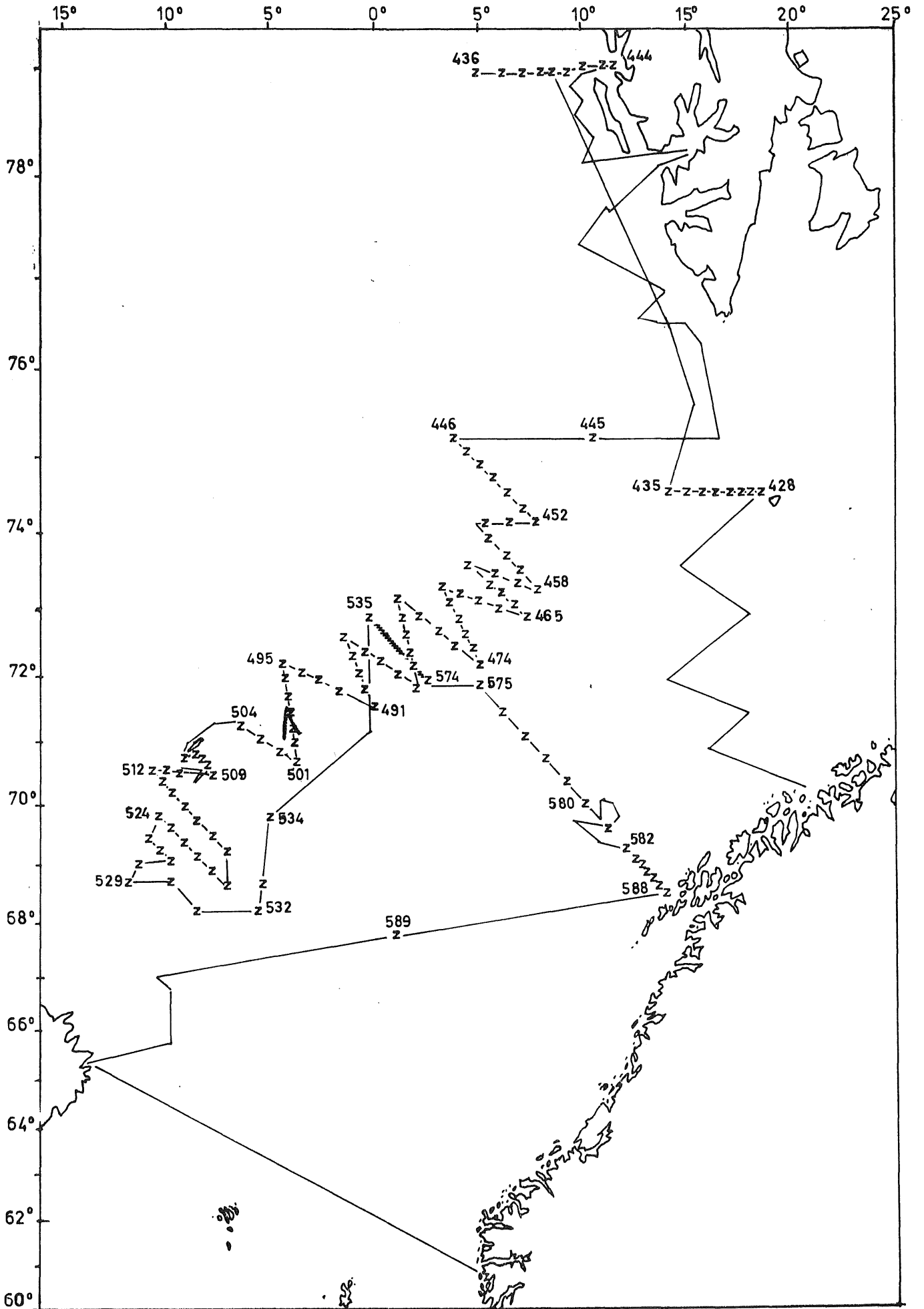

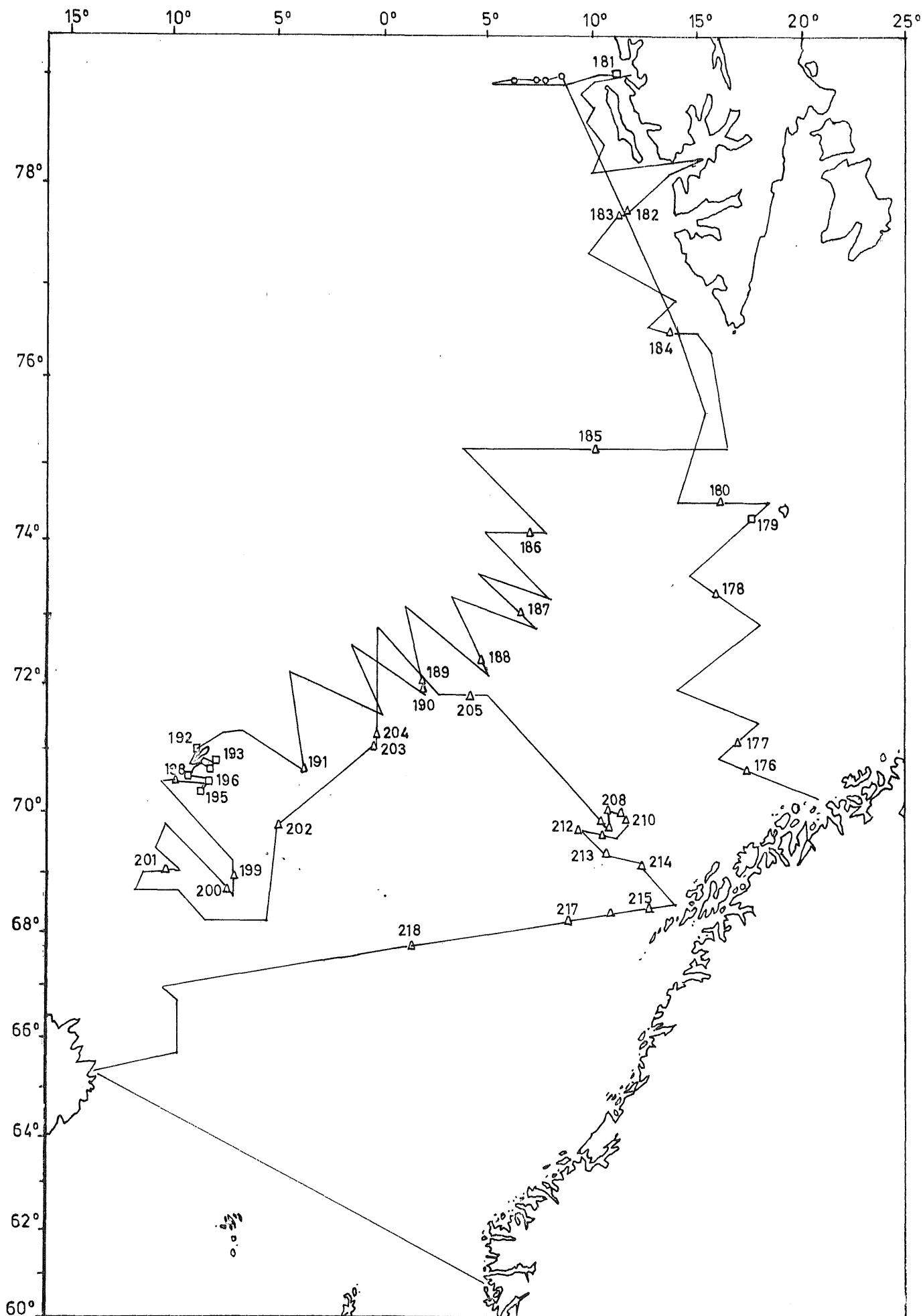

11 JUL. - 11 AUG. 1976 TRAWL ST. 176 - 218 ○ 4 PLANKTON ST. „G.O.SARS”



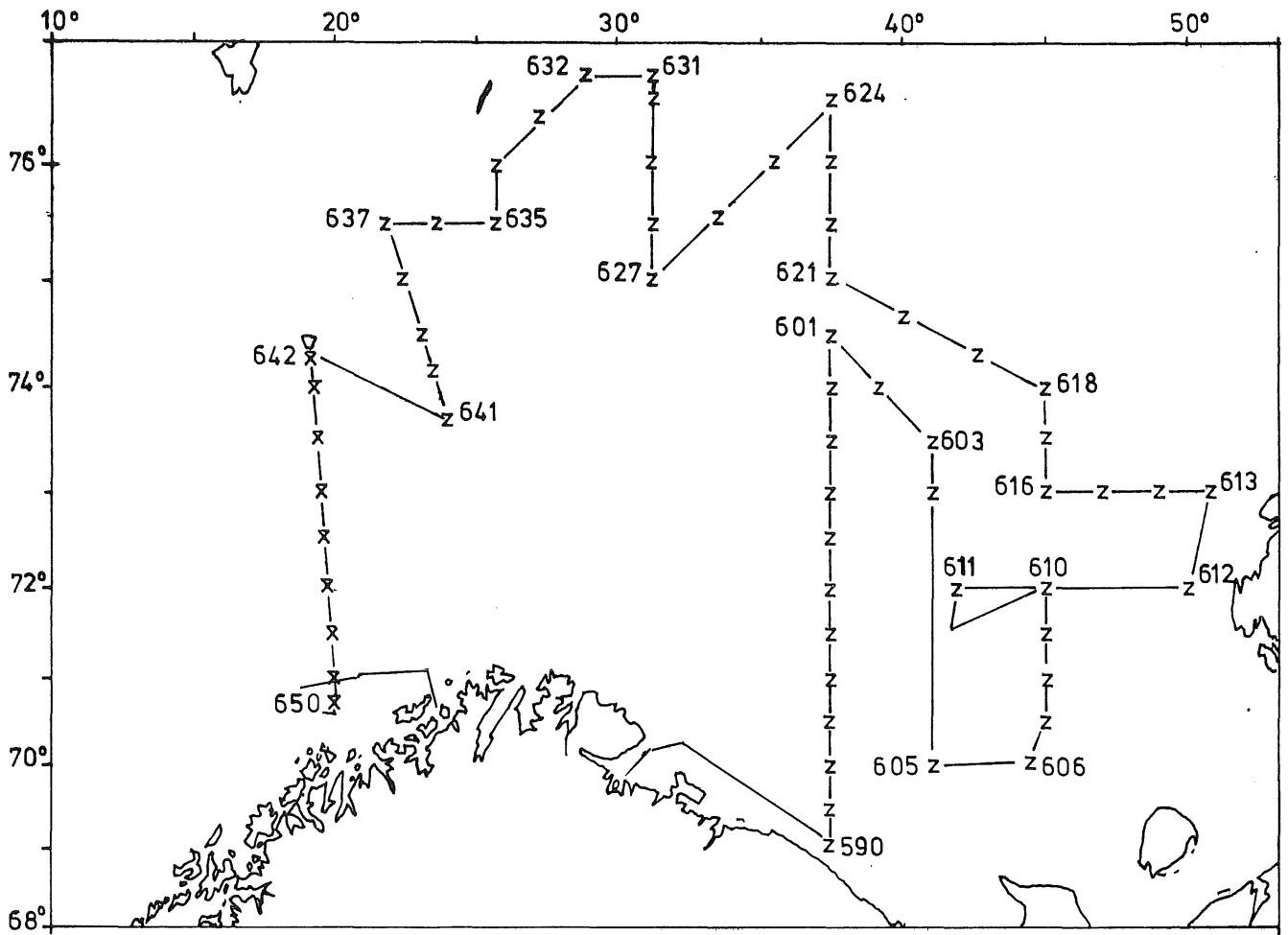

25 AUG. - 8 SEP. 1976 ST. NO. 590 - 650

„G.O. SARS“

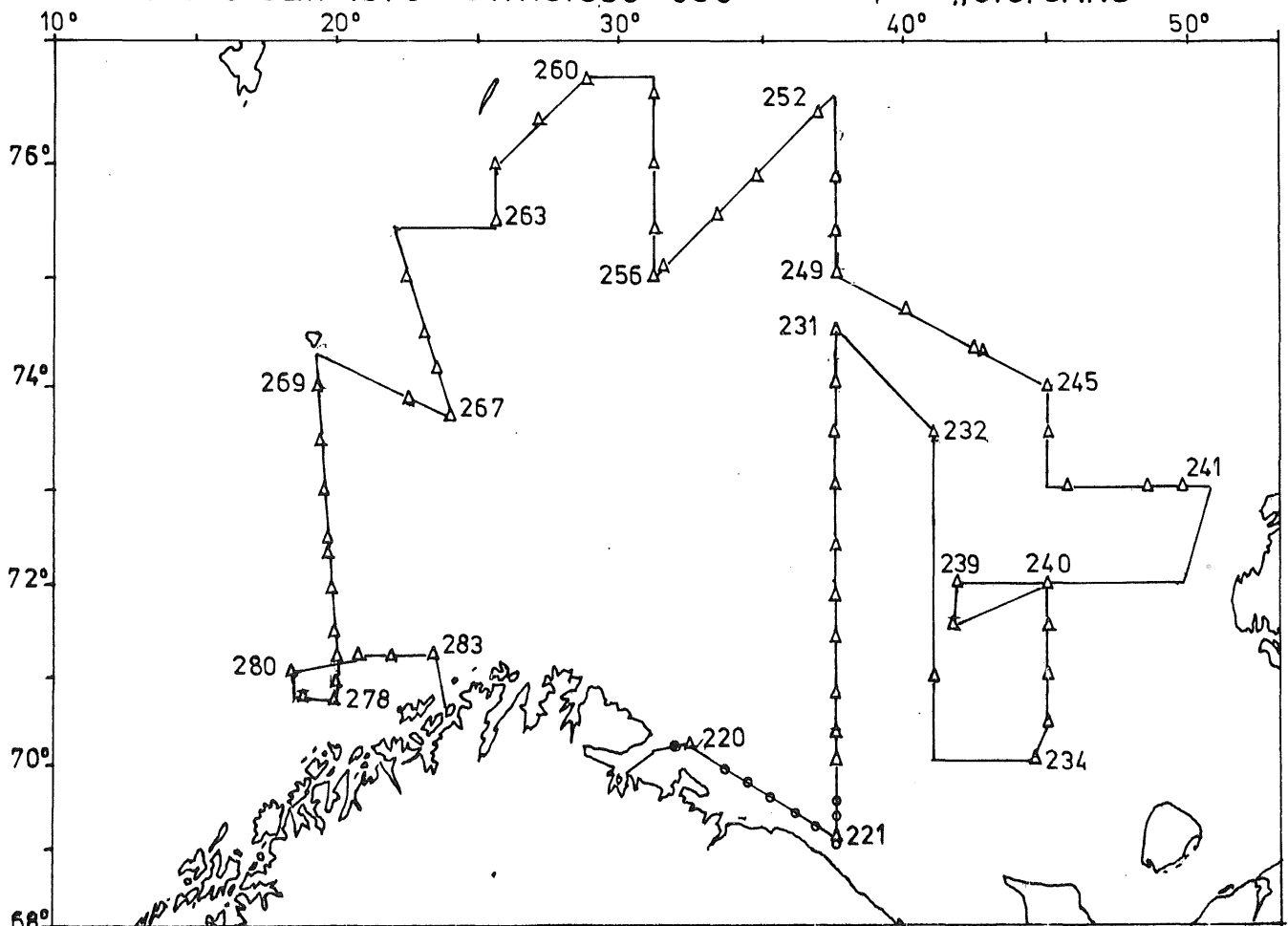

TRAWI ST 220 - 283

• 9 PLANKTON ST.

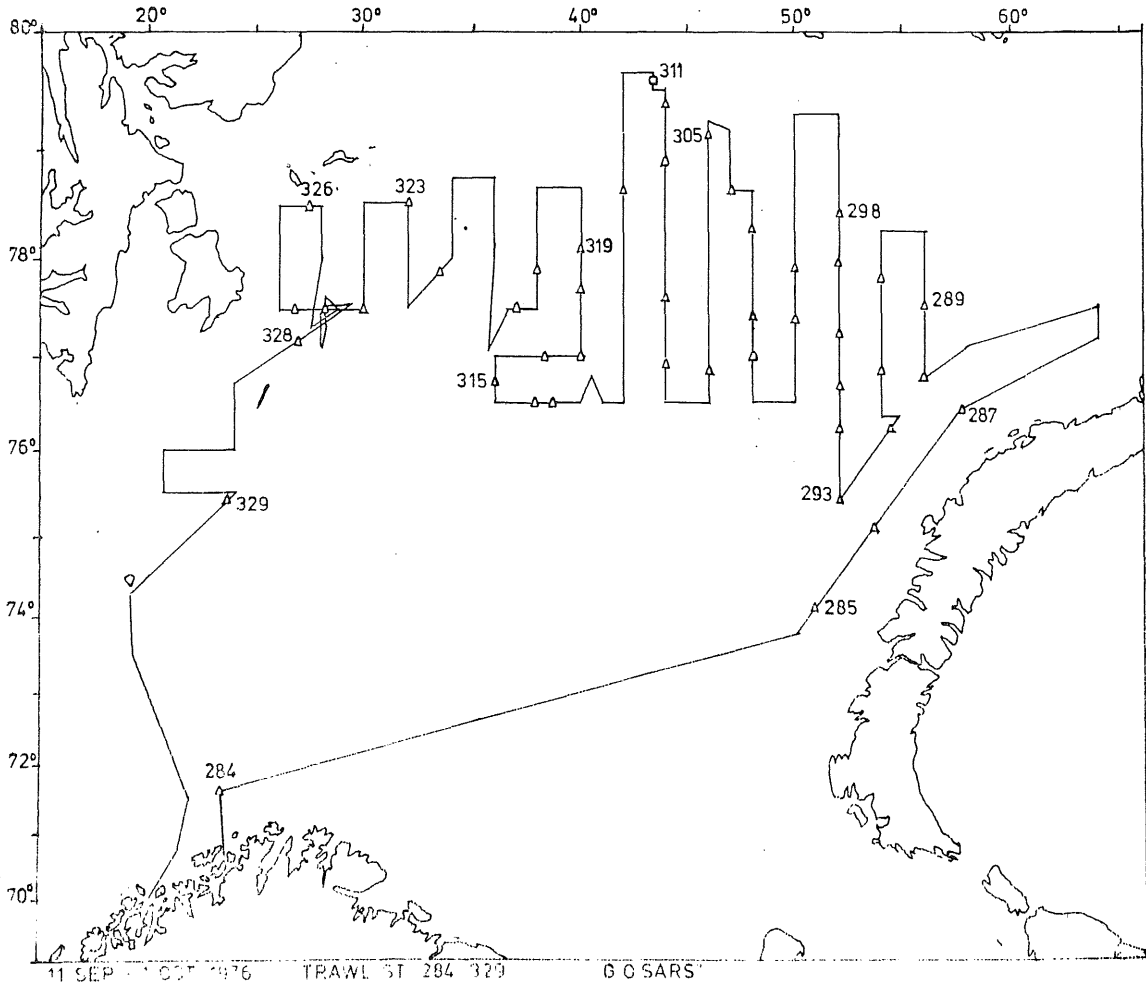
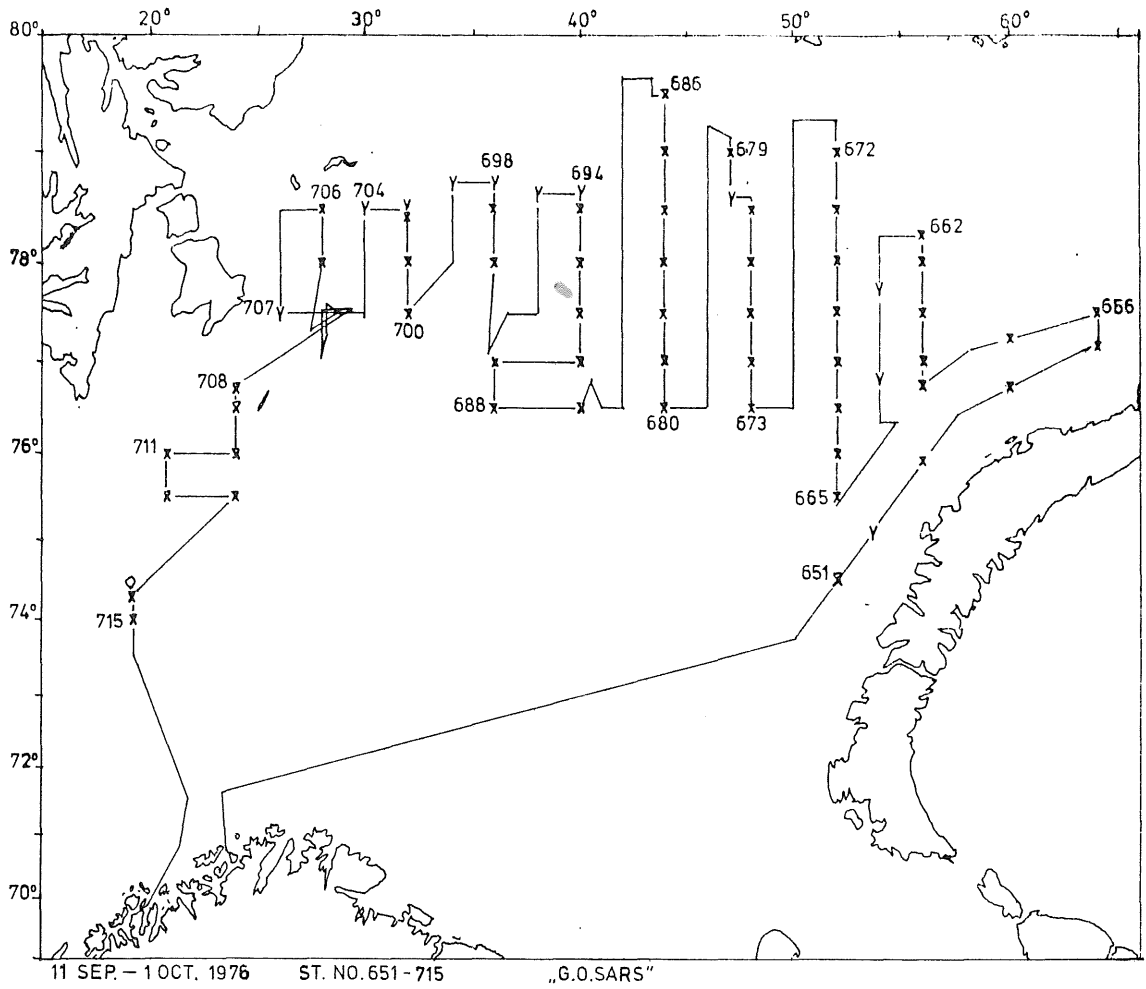

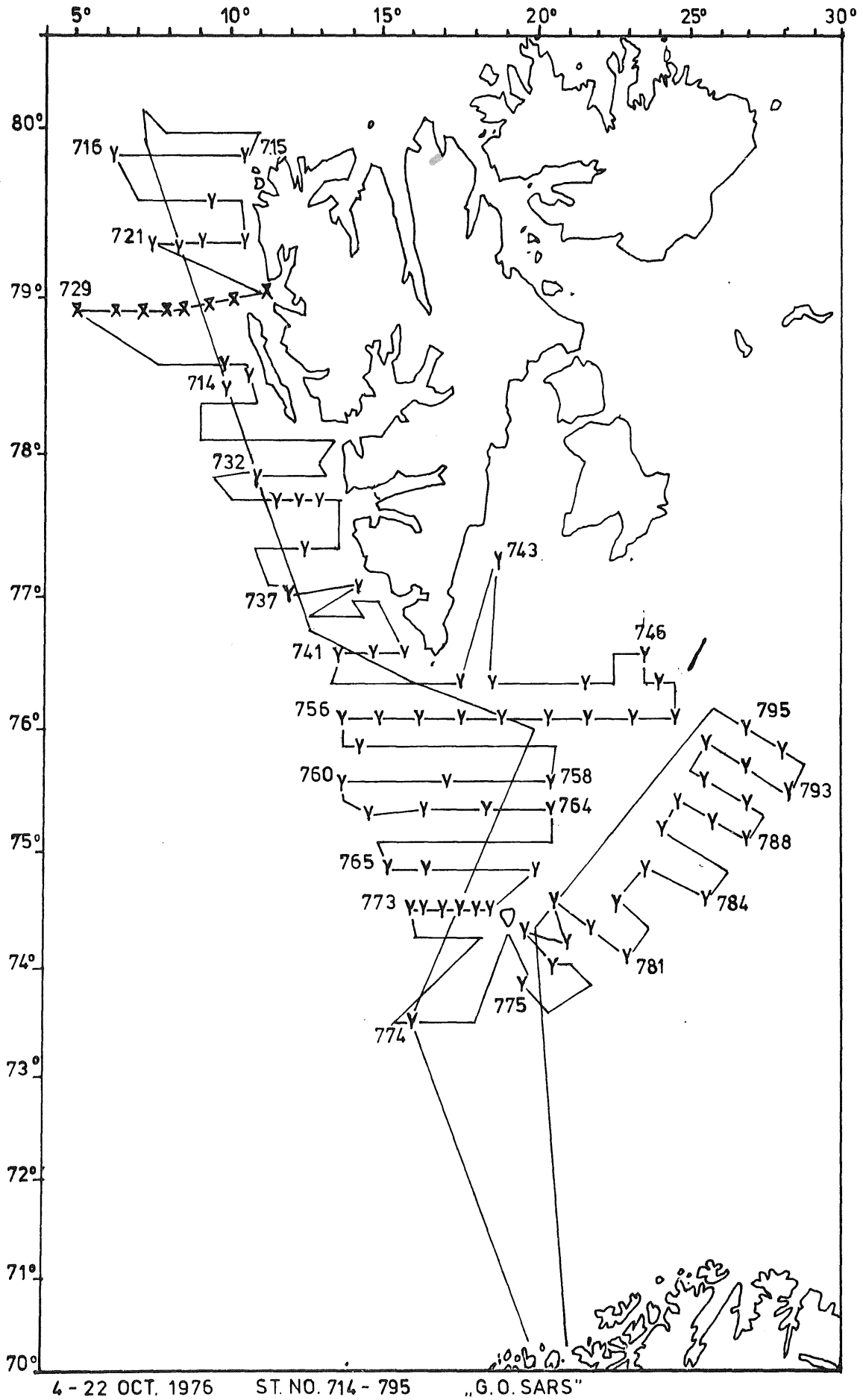

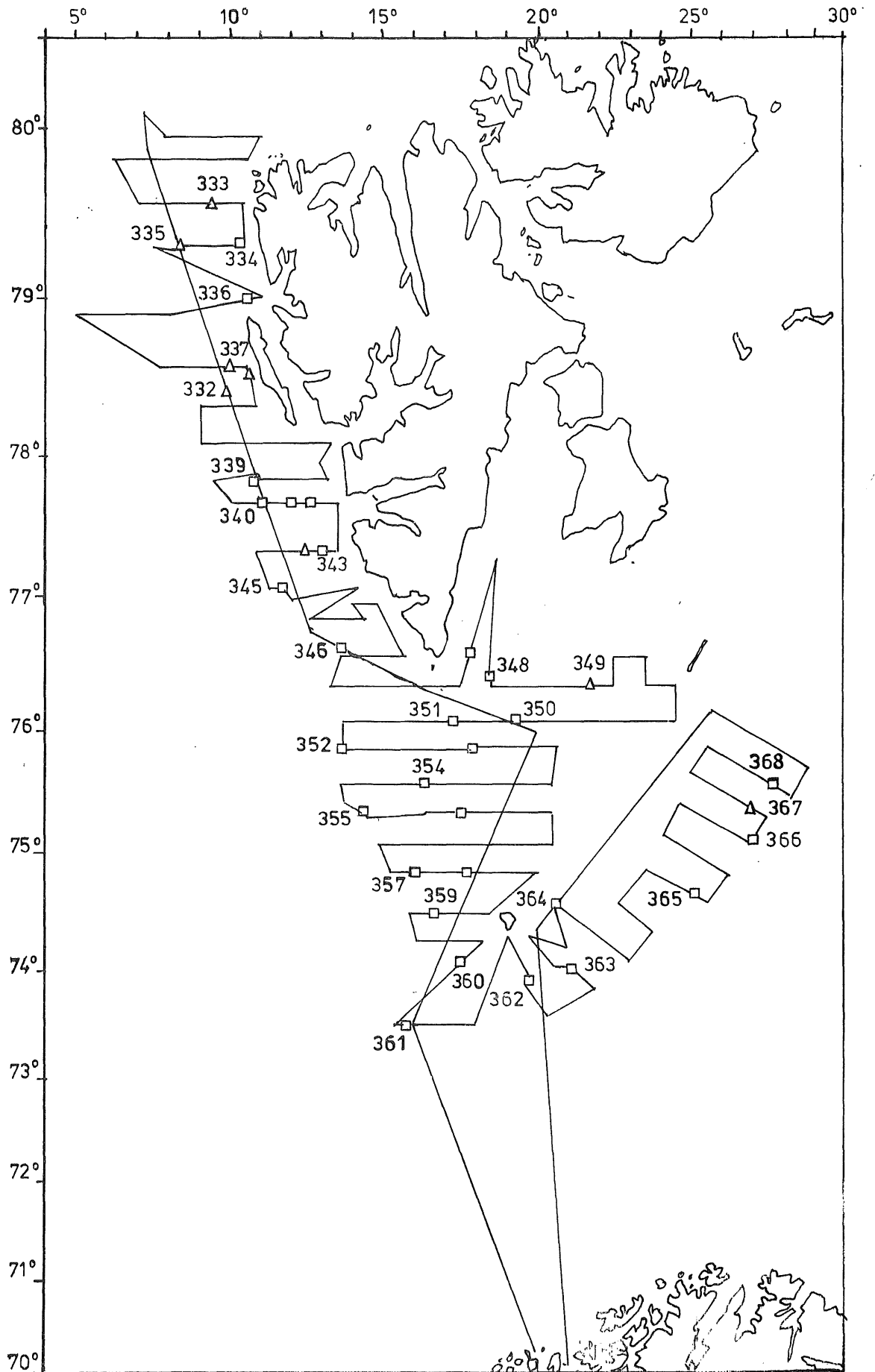

4-22 OCT. 1976 TRAWL. ST. 332 - 368 „G.O. SARS“

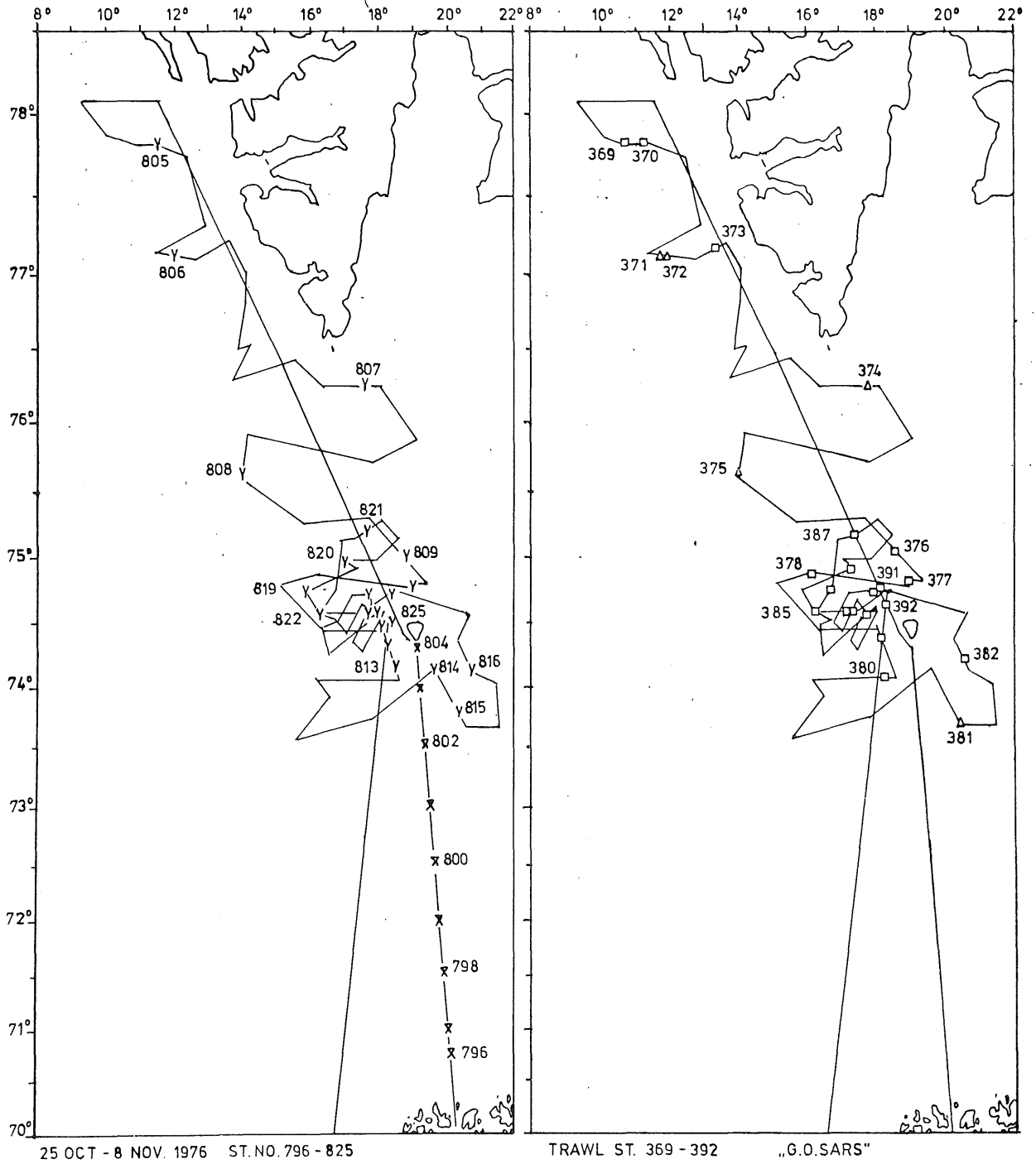

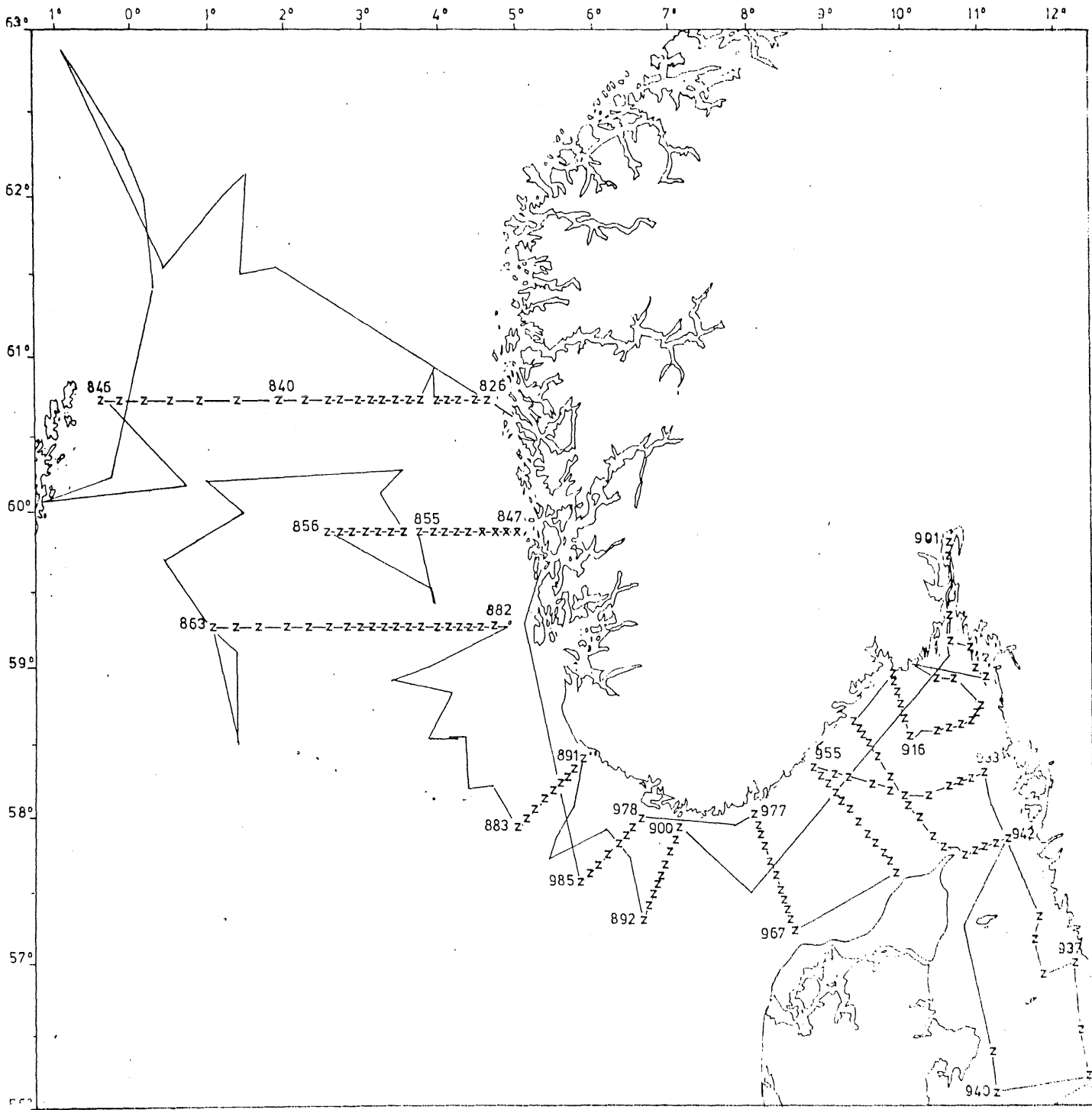

15 NOV. - 12 DEC. 1976

ST. NO 826-985

„G O SARS“

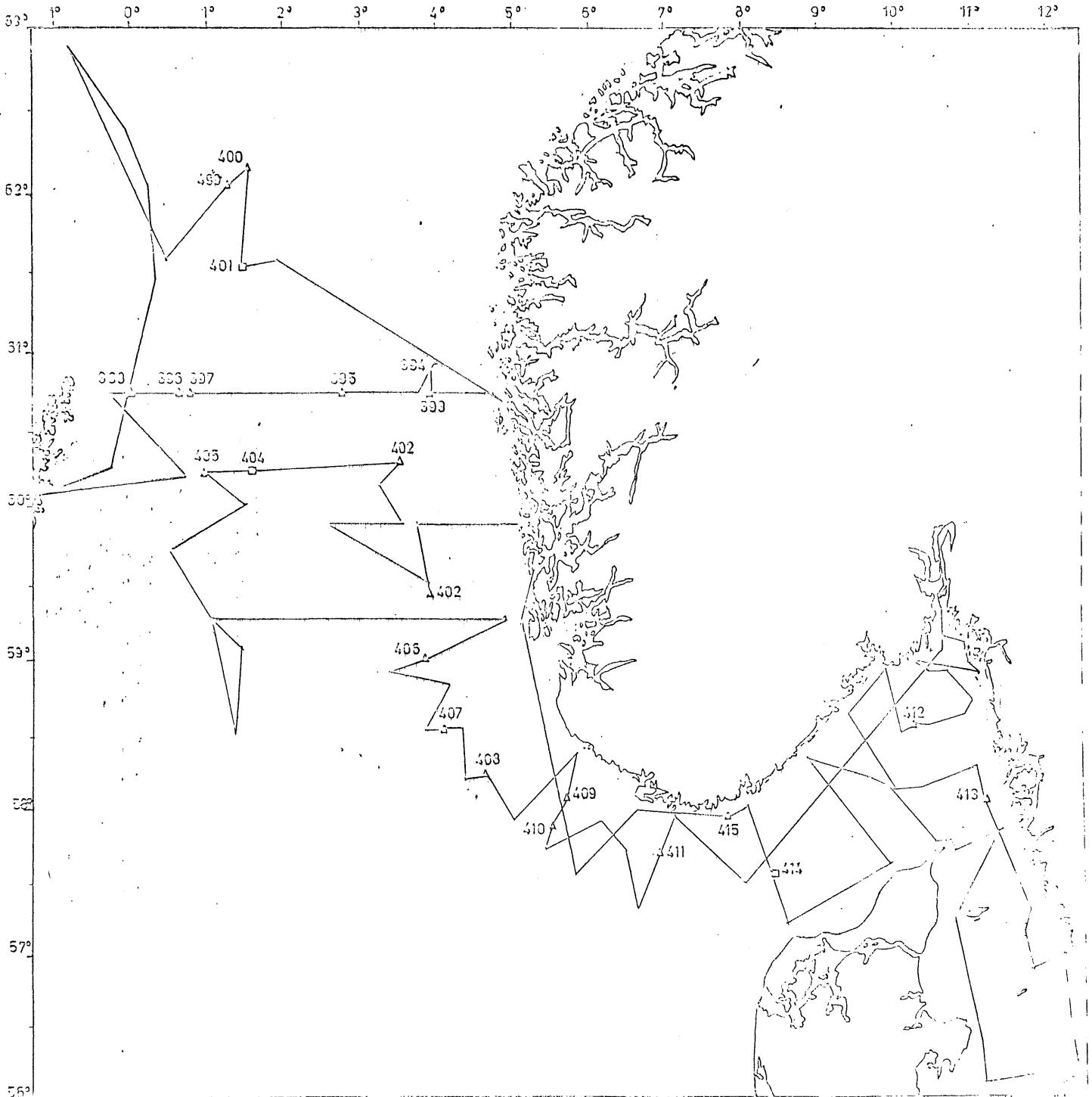

13 NOV. - 12 DEC. 1975 TRAWL ST. 399-415 "S.O.SARS"

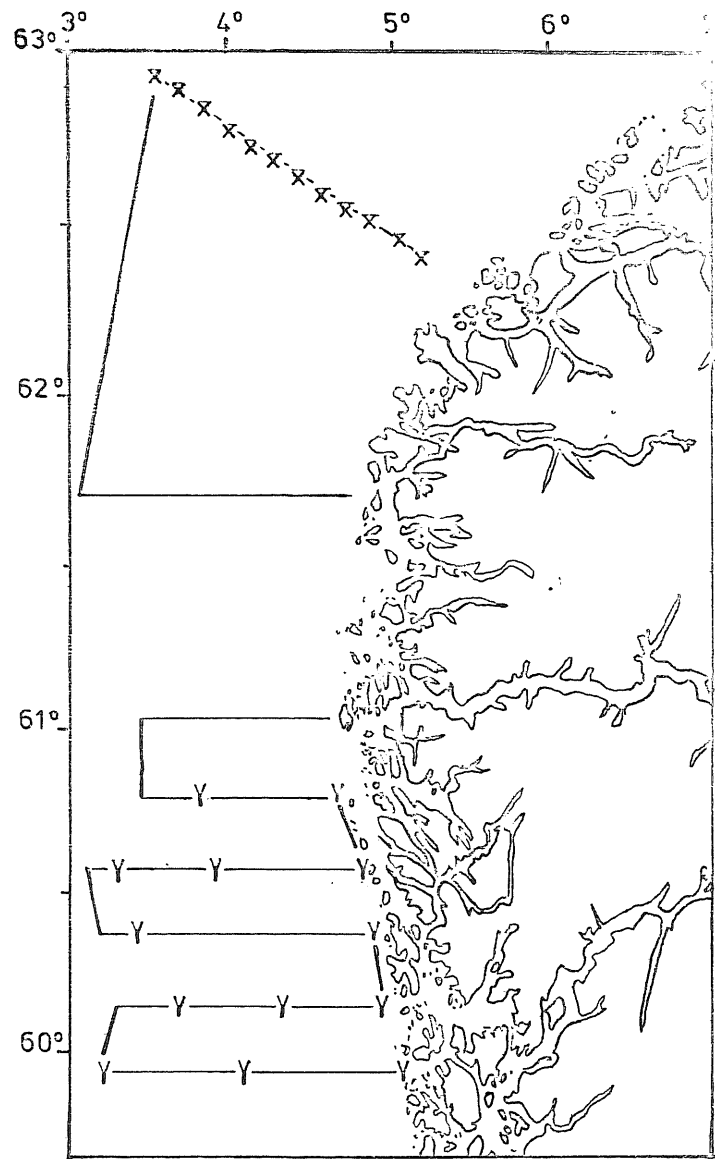

5-12 MAY 1976 12 C.O. ST 13 BT ST. PLANKTON ST. 145-219

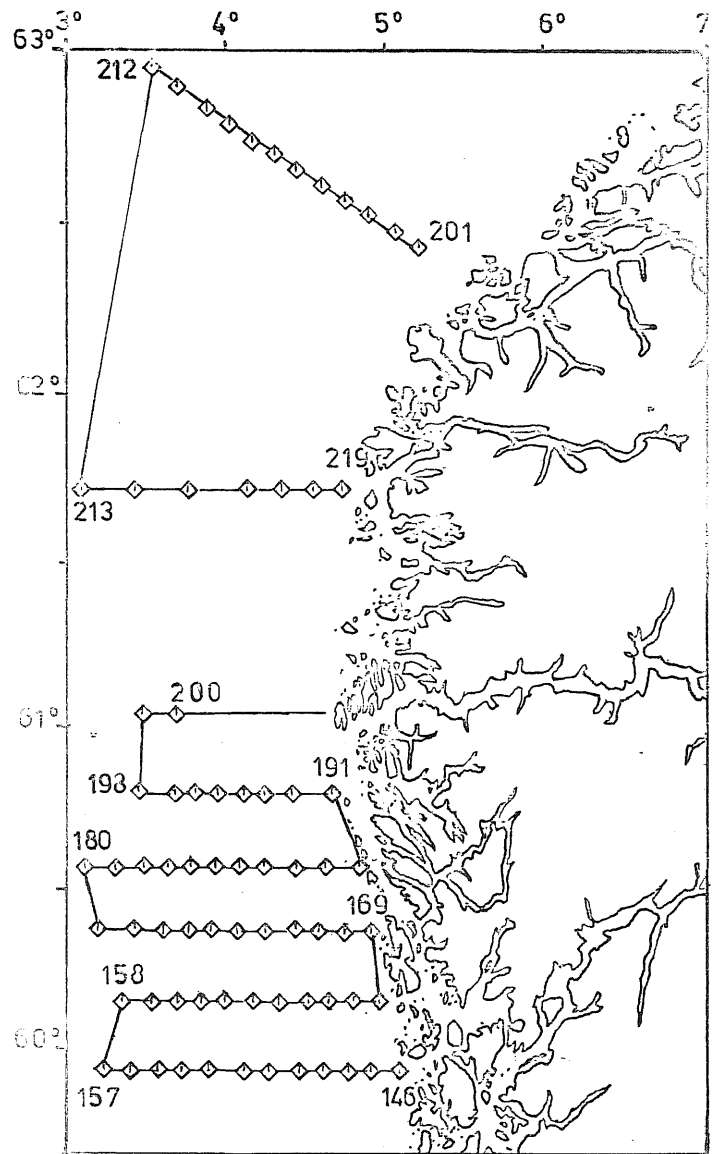

„PEDER RÖNNESTAD”



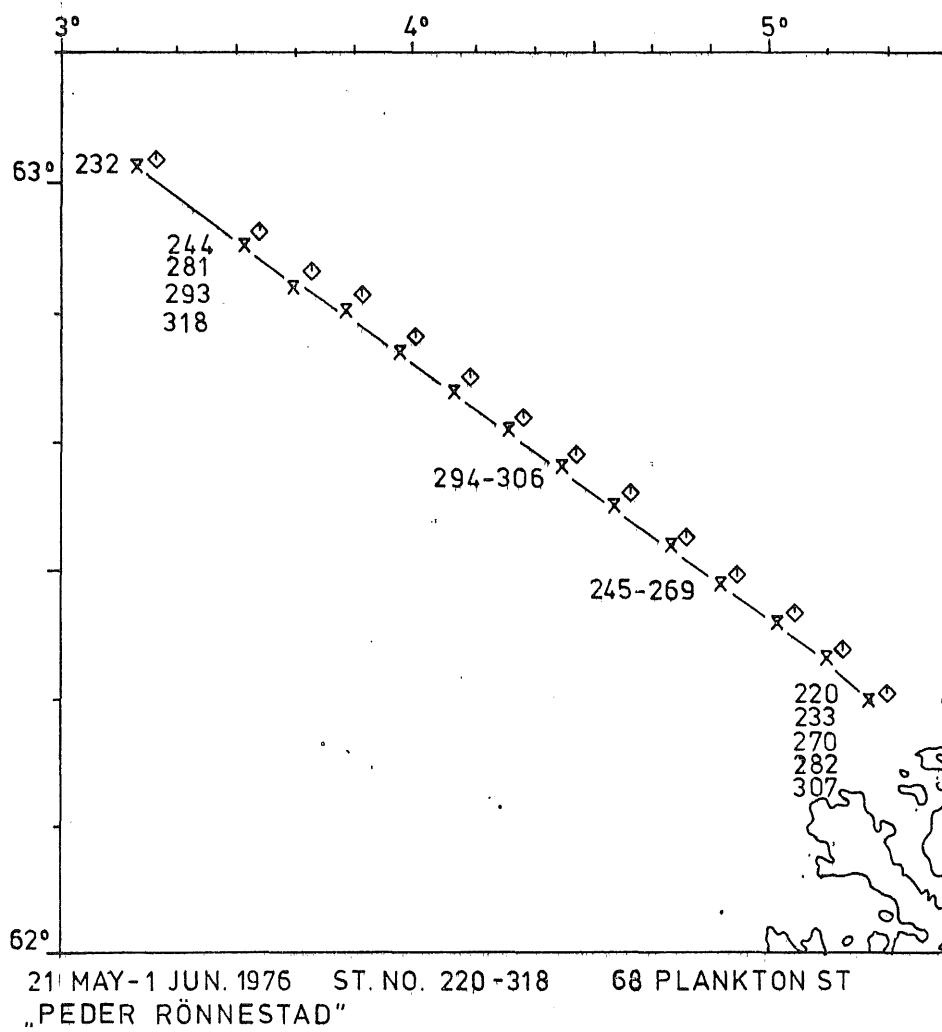

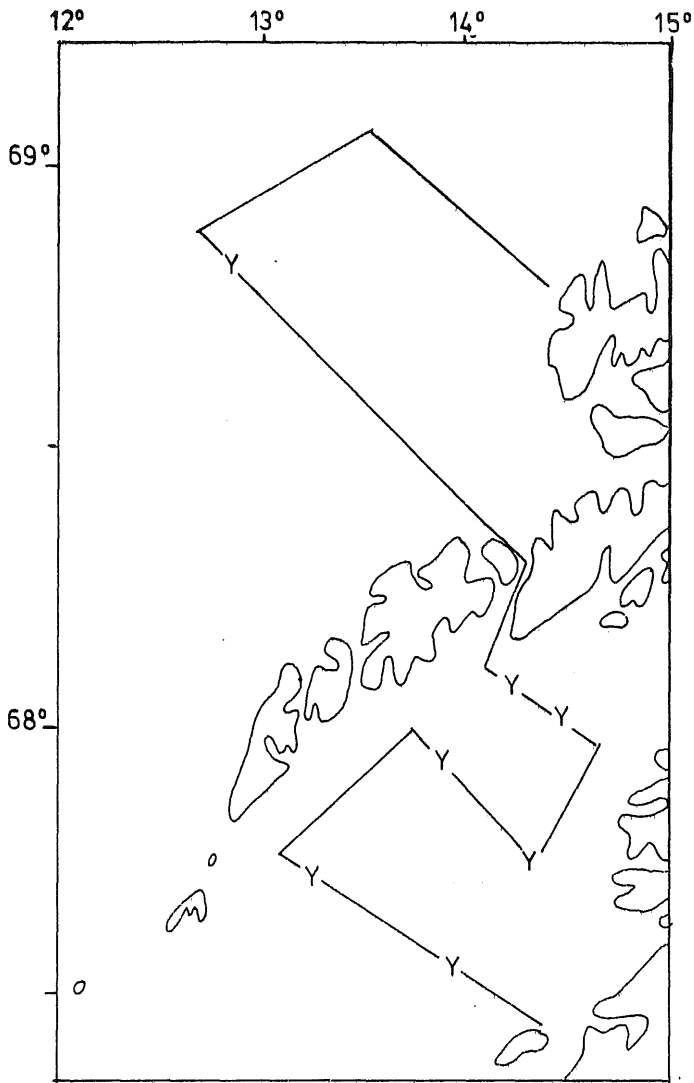

12-14 JUN 1976 7 BT ST.

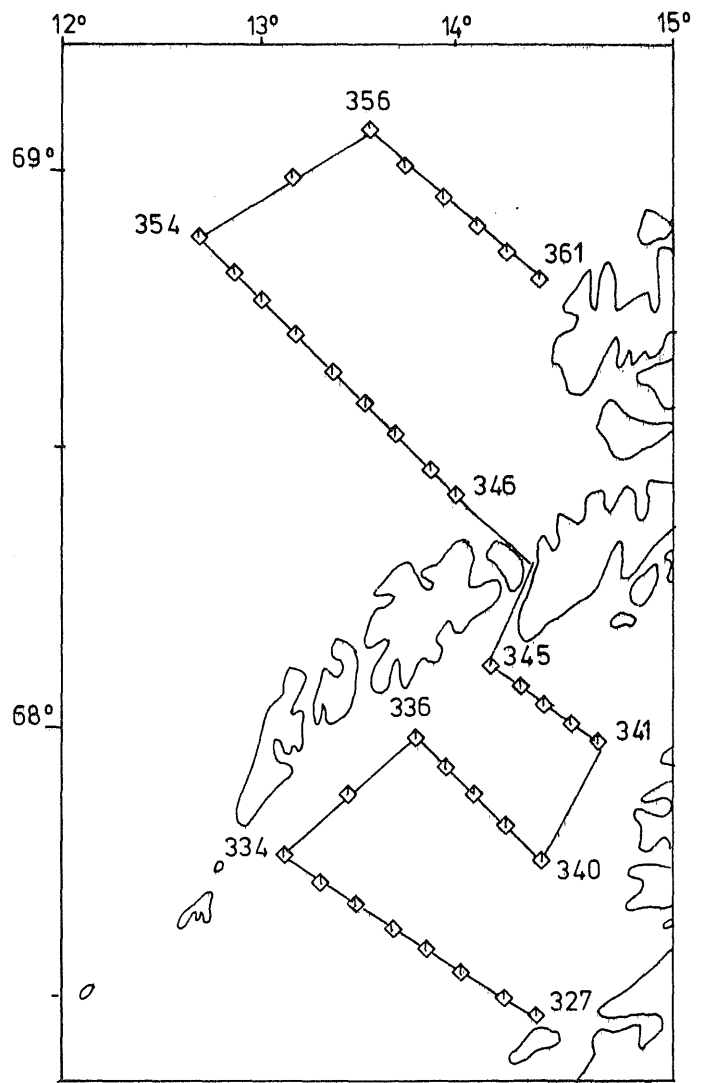

PLANKTON ST. 327-361

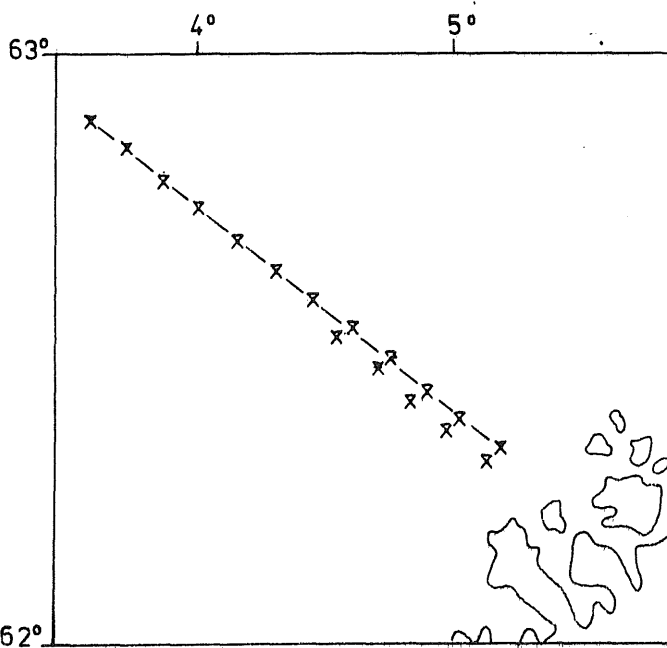

10 JUN. 17-18 JUN. 17 CI. Oc. ST.  
„PEDER RÖNNESTAD”

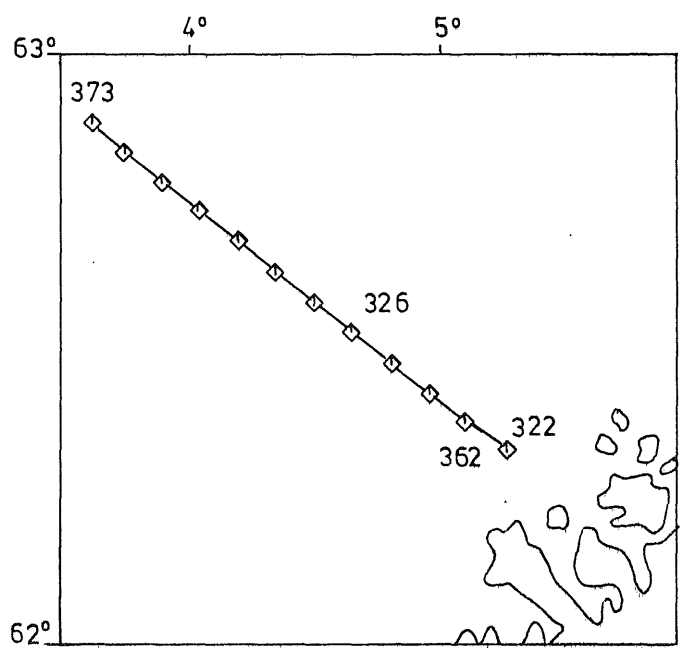

PLANKTON ST. 322-326 362-373

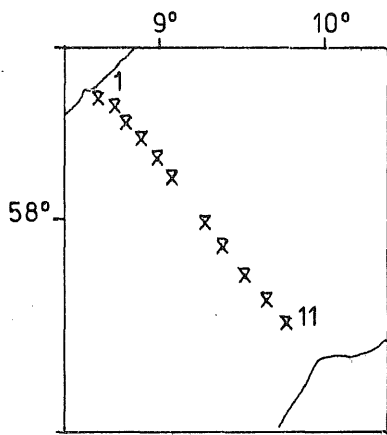

13 JAN. 1976 ST. NO. 1-11

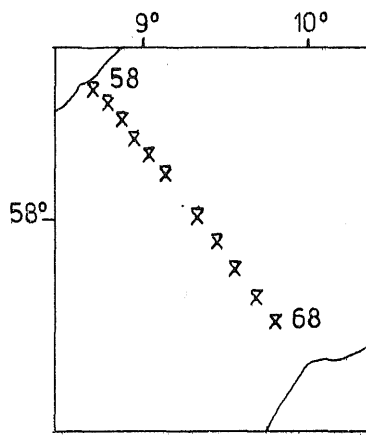

23 FEB. 1976 ST. NO. 58-68

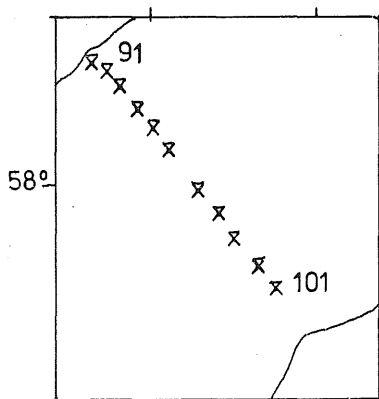

15 MAR. 1976 ST. NO. 91-101

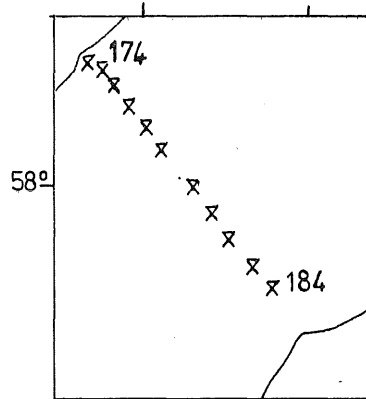

26 APR. 1976 ST. NO. 174-184

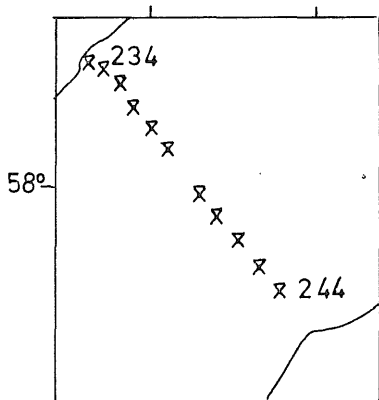

25 MAY 1976 ST. NO. 234-244

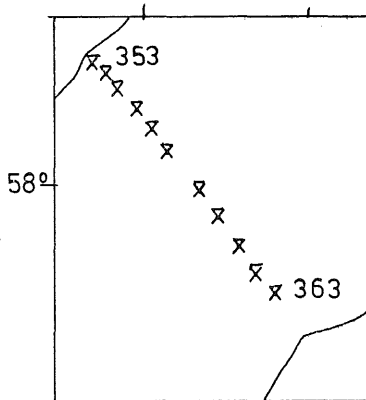

25 AUG. 1976 ST. NO. 353-363

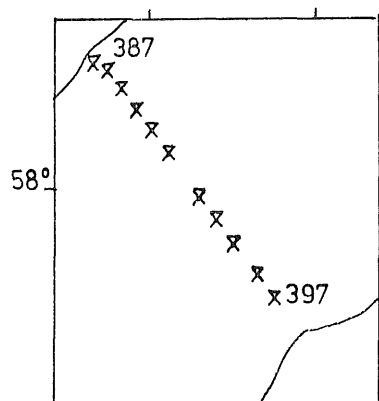

13 SEP. 1976 ST. NO. 387-397

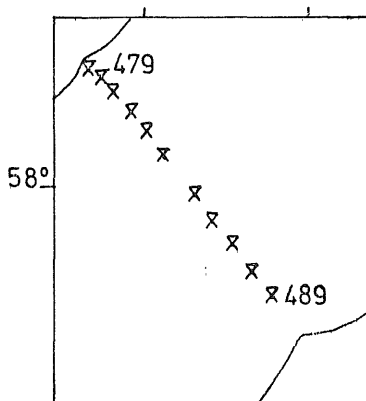

16 NOV. 1976 ST. NO. 479-489

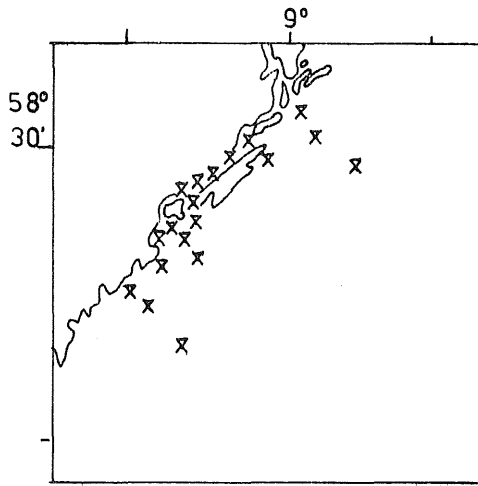

21-22 JAN 1976 ST.NO. 12-30

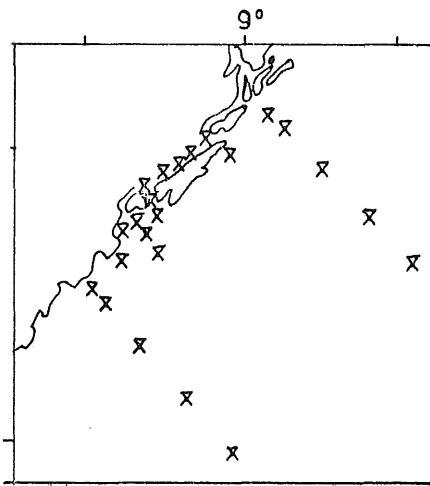

17-19 MAR.1976 ST.NO. 102-124

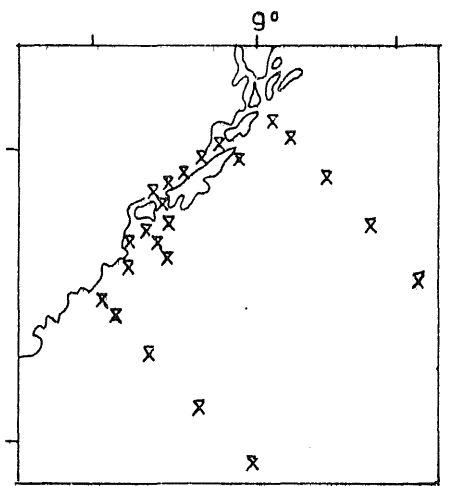

21-23 APR.1976 ST.NO. 151-173

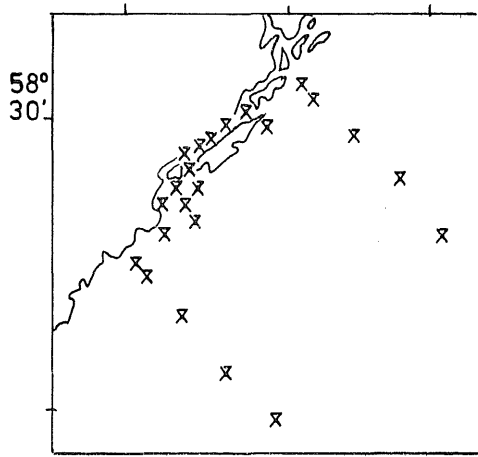

19-21 MAY 1976 ST.NO. 212-233

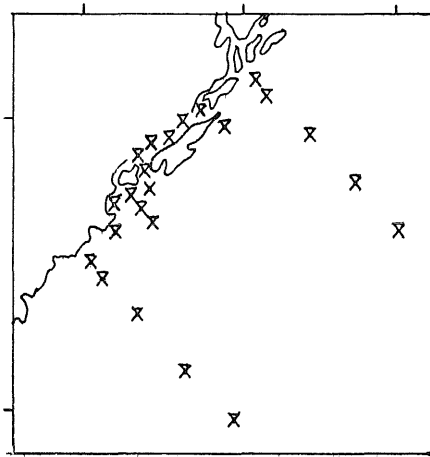

21-23 JUN.1976 ST.NO. 272-294

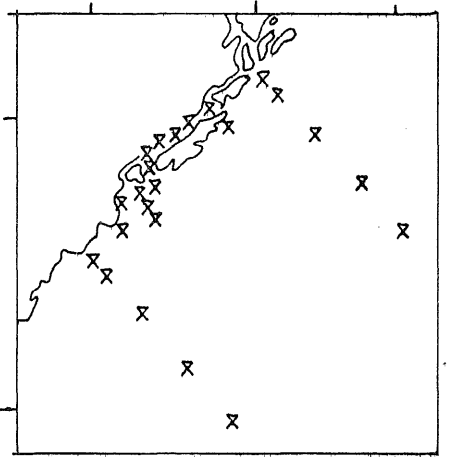

4-6 AUG. 1976 ST.NO. 303-325

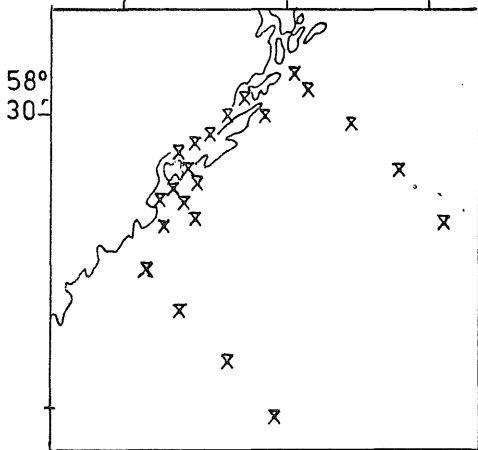

8-10 SEP. 1976 ST. NO. 364-386

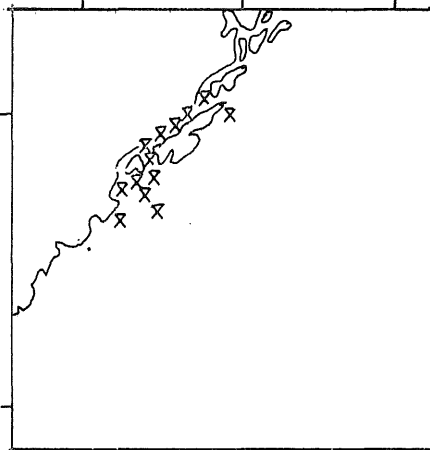

11 OCT. 1976 ST.NO. 432-443

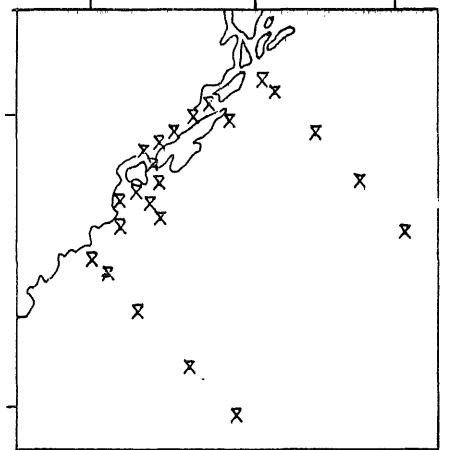

23-24 NOV.1976 ST.NO. 500-522

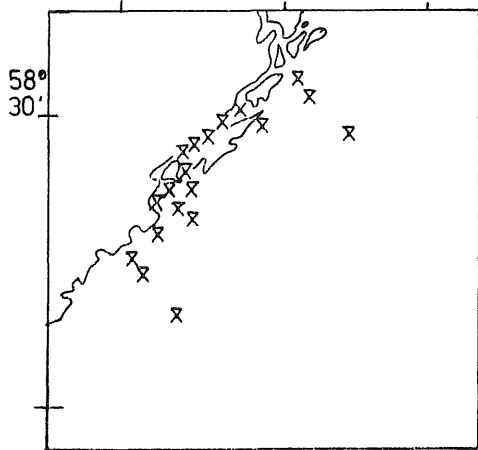

13-16 DEC.1976 ST.NO. 523-541

„G.M.DANNEVIG“

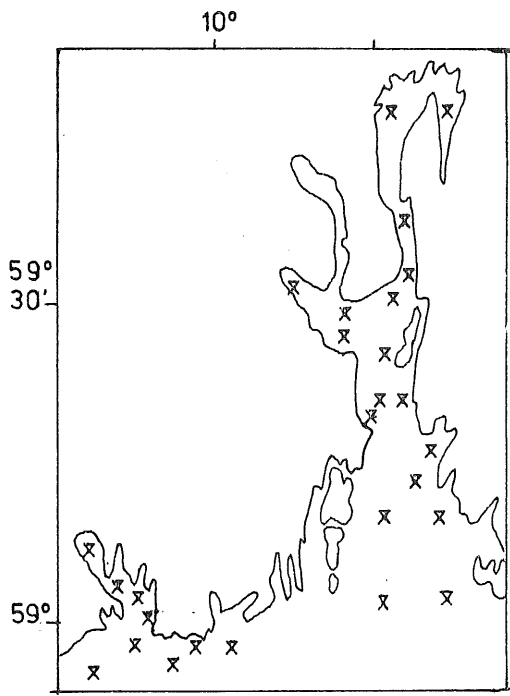

4-13 FEB. 1976 ST. NO. 31-51 + 6 ST.

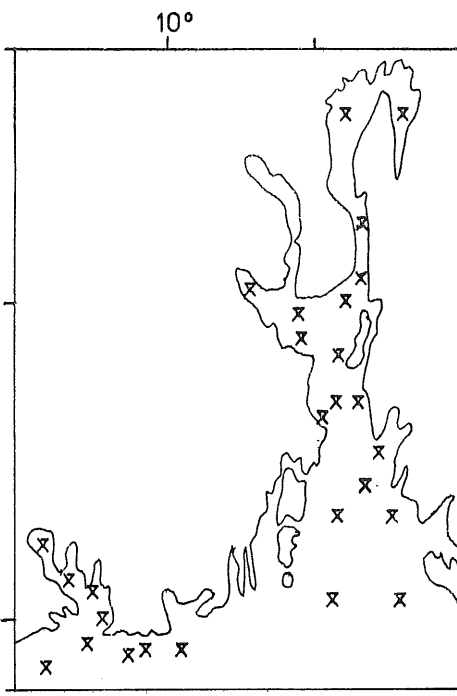

1-11 MAR. 1976 ST. NO. 65-85 + 6 ST.

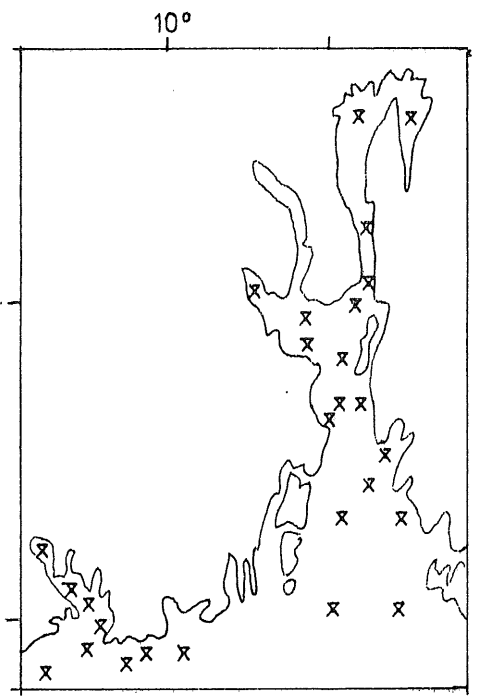

9 MAR-7 APR. ST. NO. 125-150 + 6 ST.

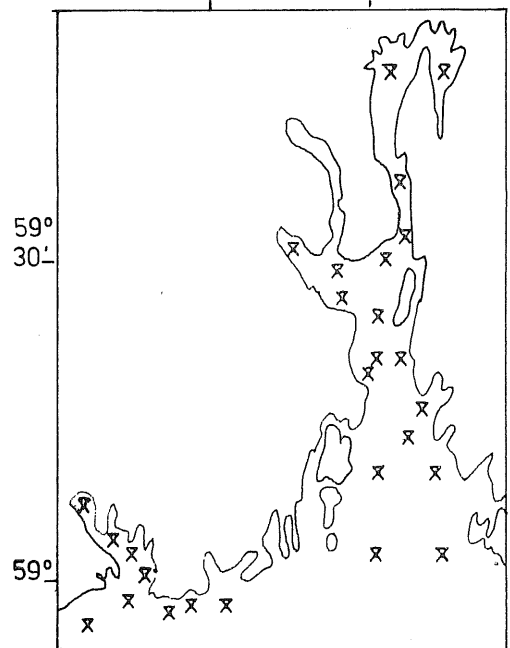

4-11 MAY 1976 ST. NO. 186-206 + 6 ST.

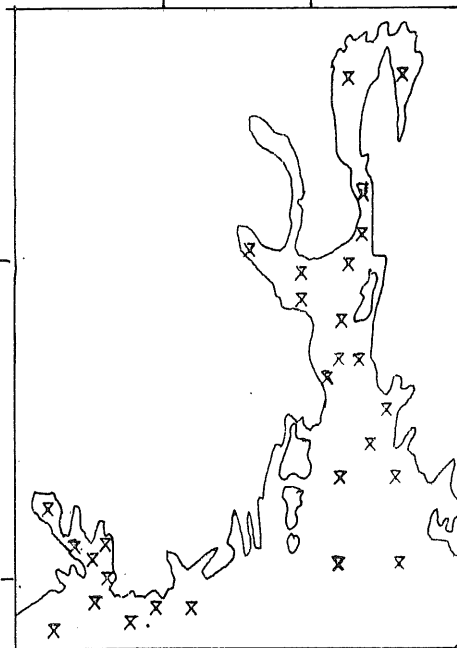

8-17 JUN. 1976 ST. NO. 246-269

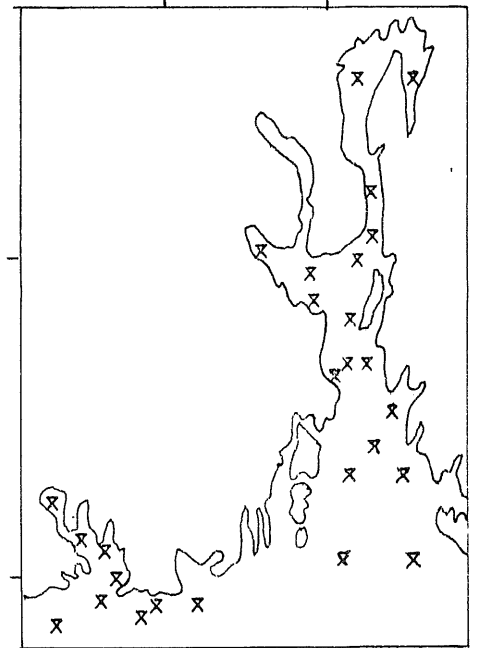

9-18 AUG. 1976 ST. NO. 327-347 + 6 ST.

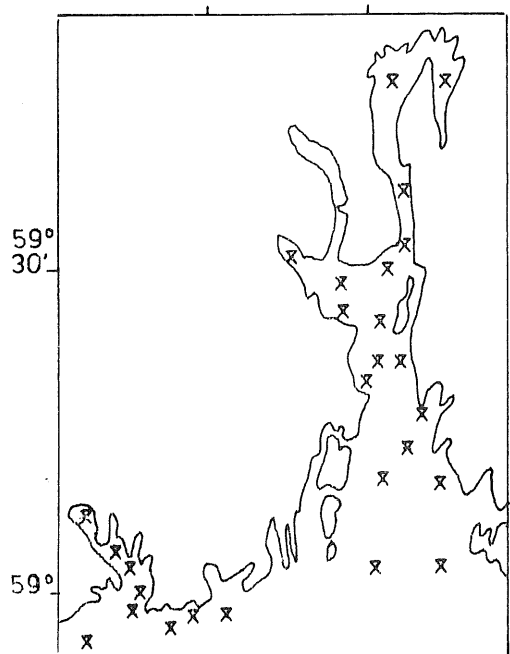

1-12 NOV. 1976 ST. NO. 456-477 + 6 ST.

„G. M. DANNEVIG.”

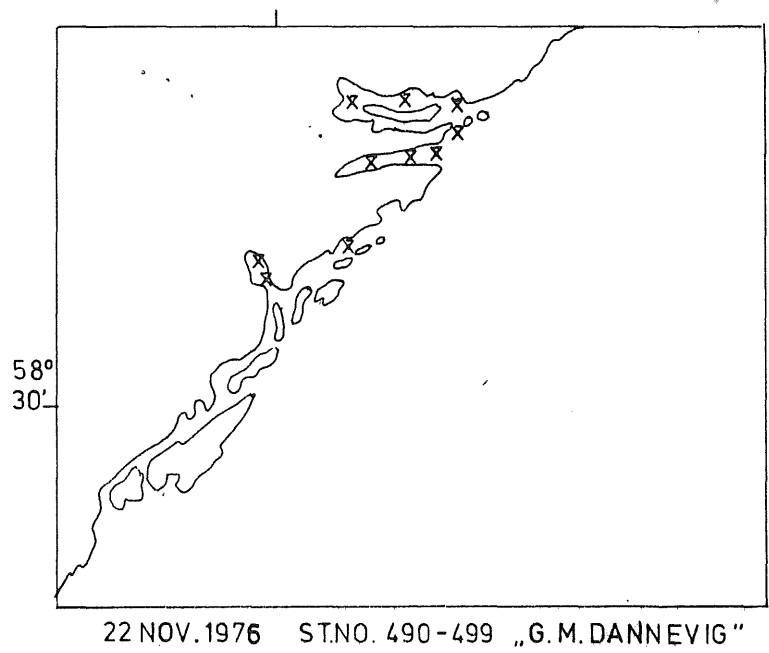
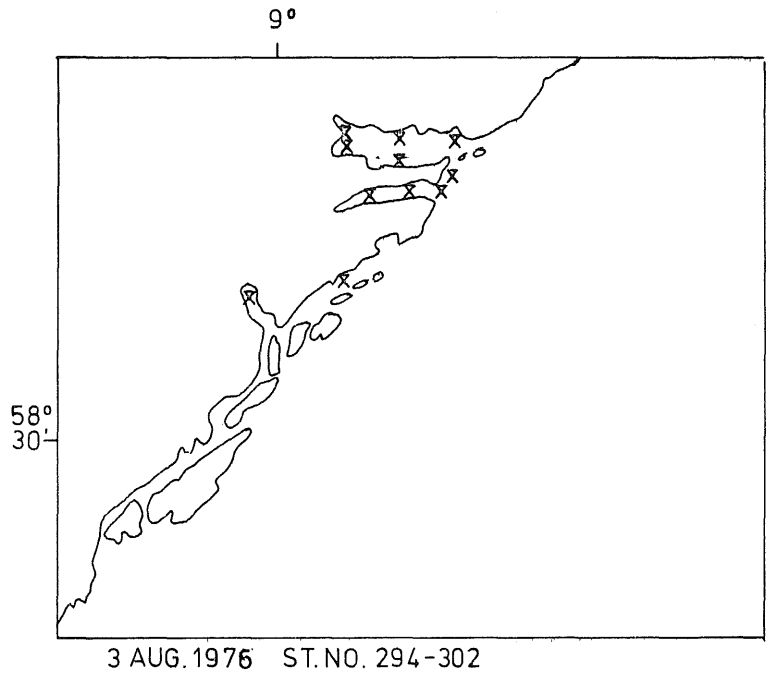

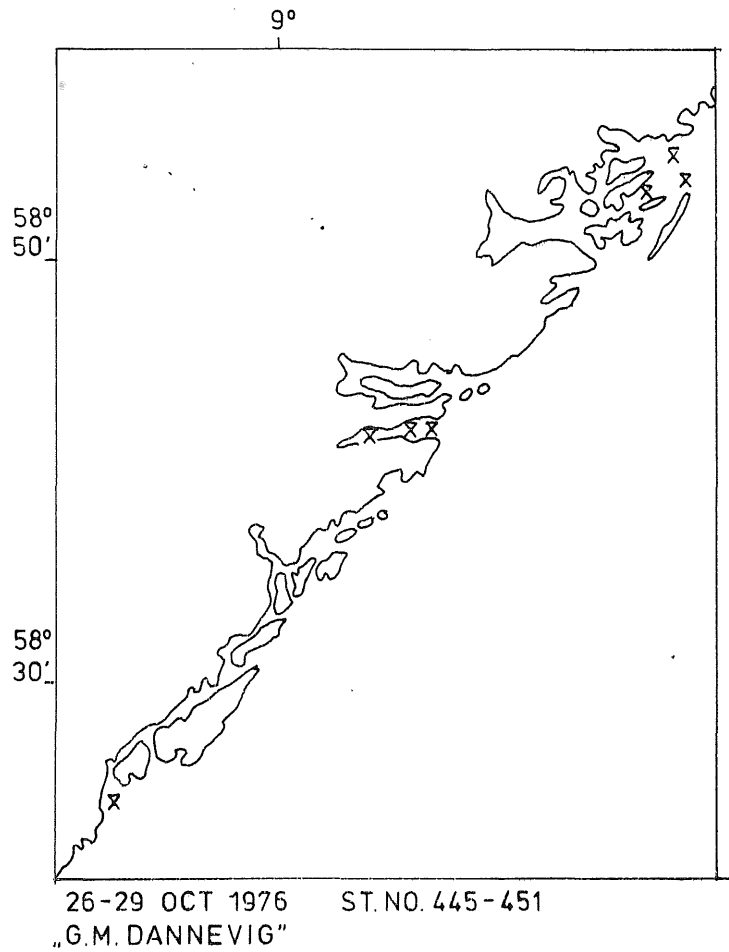
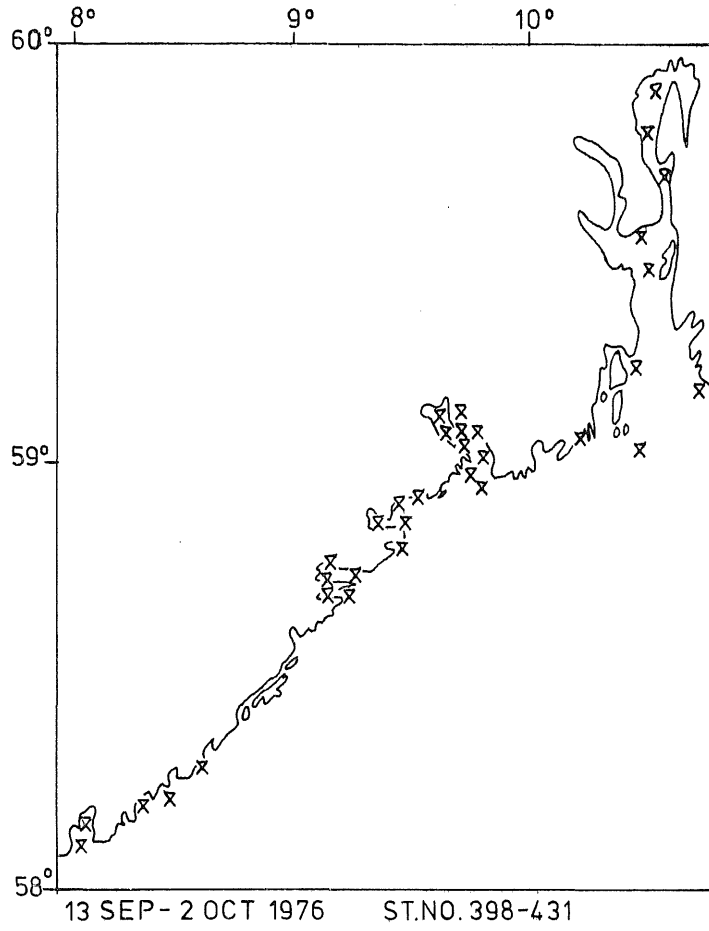

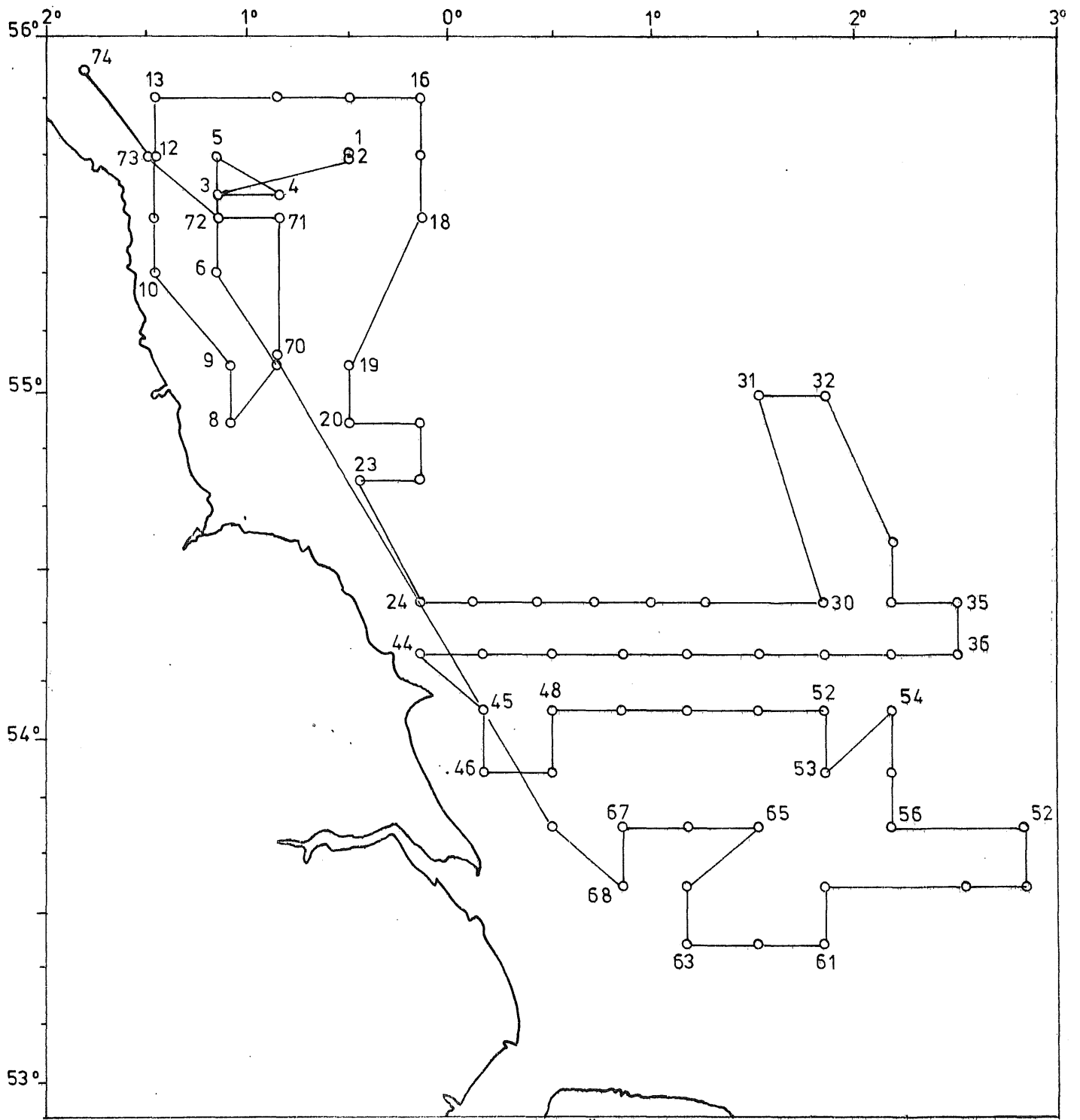

19-25 OCT. 1976 LARVAE ST. 1-74 „HAVDRÖN”



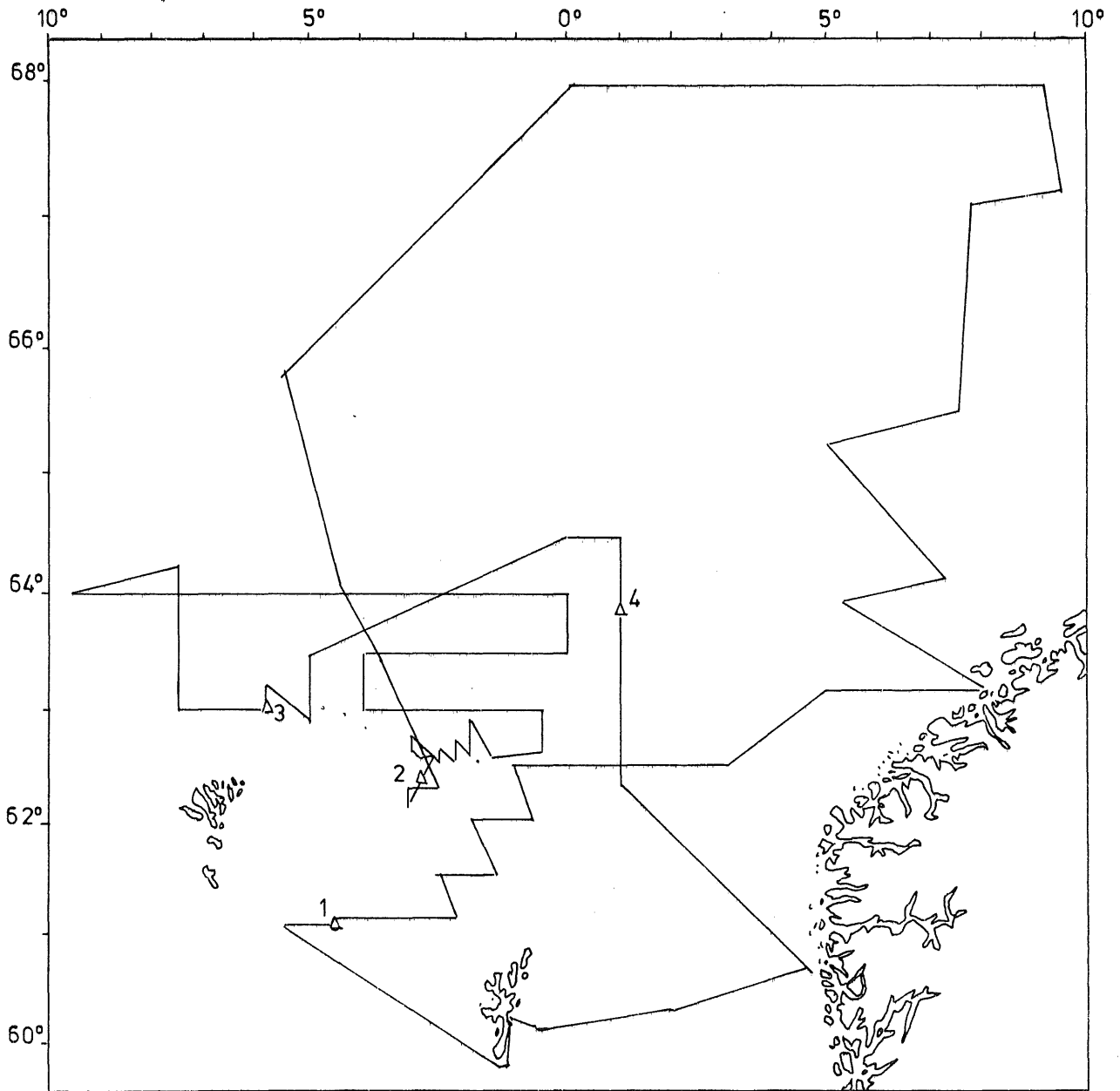

28 NOV.-16 DEC. 1976 TRAWL ST. 1-4 „HAVDRÖN“