

report on oceanographic cruises and data stations

1975

Harald Kismul

fiskeridirektoratets
havforskningsinstitutt

Bergen - Norge

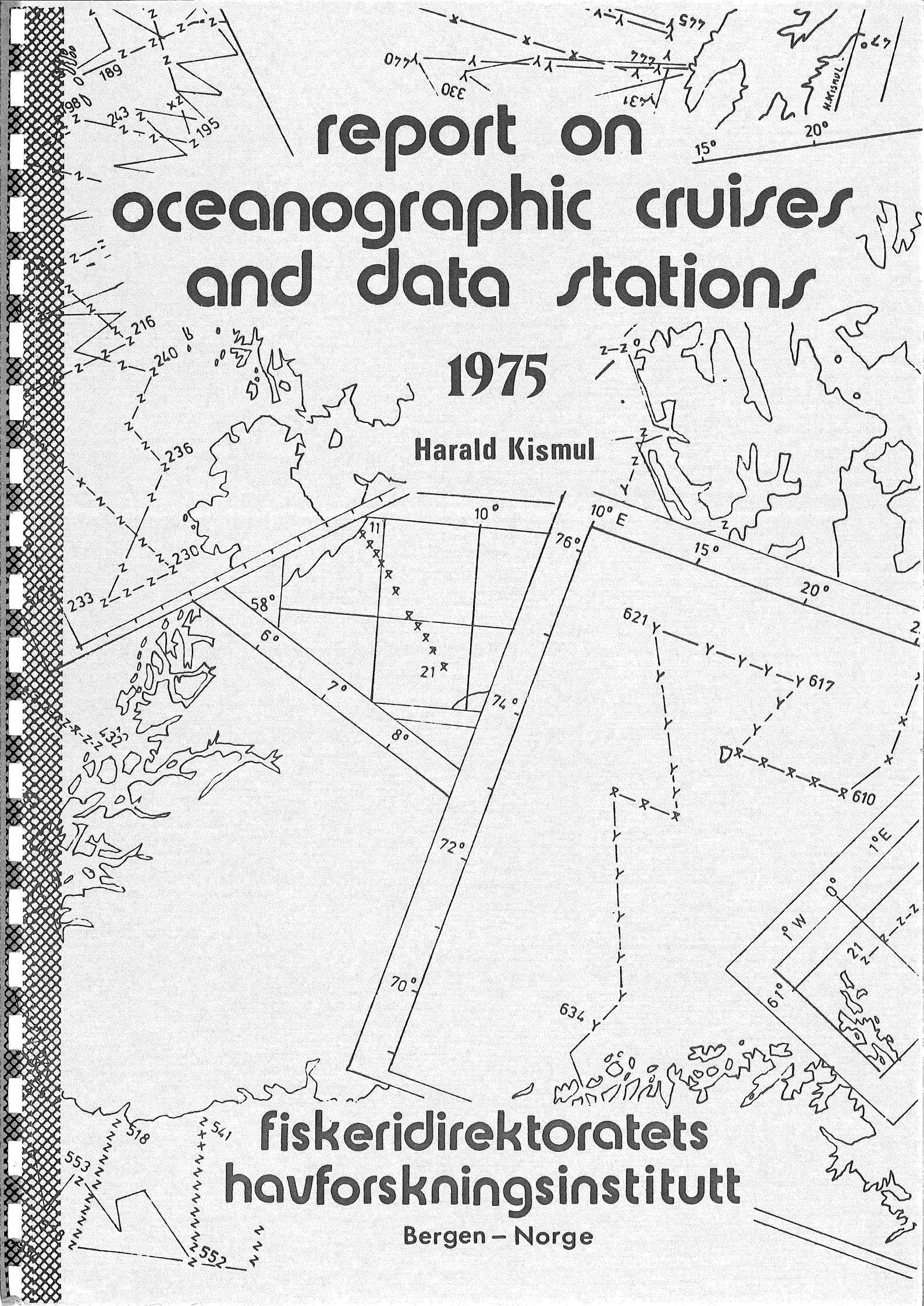

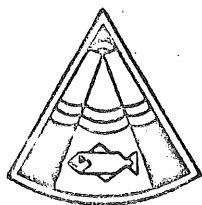

report on oceanographic cruises and data stations

1975

Harald Kismul

Guidelines:

- x Classical oceanogr. stations
- Z Vertical profiles (STD/CTD)
- Y Bathythermograph (BT)
- △ Moored buoy station
- △ Pelagic Trawl station
- Bottom Trawl station
- ◇ Plankton station
- Clarke
- Taggings
- Λ Surface observations t°C S‰

fiskeridirektoratets
havforskningsinstitutt

Bergen - Norge

ICES Annual Report on Oceanographic Cruises and Data Stations.

Country: NORWAY

Year: 1975

Ship: "G.O. Sars" No. 15

Cruise and ship number.	Period of cruises	Number of Stations															Continual observations						Page of track chart			
		Classical oceanogr. stations	Vertical profiles (STD/CTD)	Bathythermograph (BT)	Moored Buoy	Oxygen	Nutrients	Oil Hydrocarbons	Petroleum residues	Metals	Primary org. prod.	Petroplank. pigment con.	Sediment samples	Pelagic Trawl	Bottom Trawl	Pelagic eggs and larvae	Taggings	Zooplankton	Phytoplankton	Surface temperature	Transparency	Organic matter (extract.)		Part. matter (filtration)	NO ₂ + NO ₃ (auto-analyzer)	Echo sounding
1/15	11/1 - 15/2	42	24	117									41	9	41	9			x	x				x	x	17-18
2/15	17/2 - 28/2			13									4	4	4	4			x	x				x	x	19
3/15	2/3 - 16/3	10		37									17	3	17	3			x	x				x	x	20
4/15	1/4 - 18/4	158		81		143			143	143		2					143		x	x				x	x	21-22
5/15	20/4 - 15/5	165					12					65	4						x	x				x	x	23-24
6/15	24/5 - 28/5	40							22	22							38	38	x	x				x	x	25
7/15	29/5 - 1/6	54				94		25	45	45							95	94	x	x				x	x	26
8/15	1/6 - 20/6	47				51		10	51	5		35		25			50	51	x	x				x	x	27
9/15	21/6 - 25/6	33				38			38	38								38	x	x				x	x	28
10/15	28/7 - 4/8	44				45		22	45	45							45	45	x	x				x	x	29
11/15	4/8 - 14/8	14		53								3	7						x	x				x	x	30-31
12/15	18/8 - 22/8	32				31		10	31	10							31	31	x	x				x	x	32
13/15	25/8 - 8/9	42		48								67							x	x				x	x	33
14/15	14/9 - 6/10	46										51	2						x	x				x	x	34-35
15/15	8/10 - 13/10	35				35		16	35	35							35	35	x	x				x	x	36
16/15	10/11 - 08/12	33		23		43						11	2	58			58		x	x				x	x	37-38-39

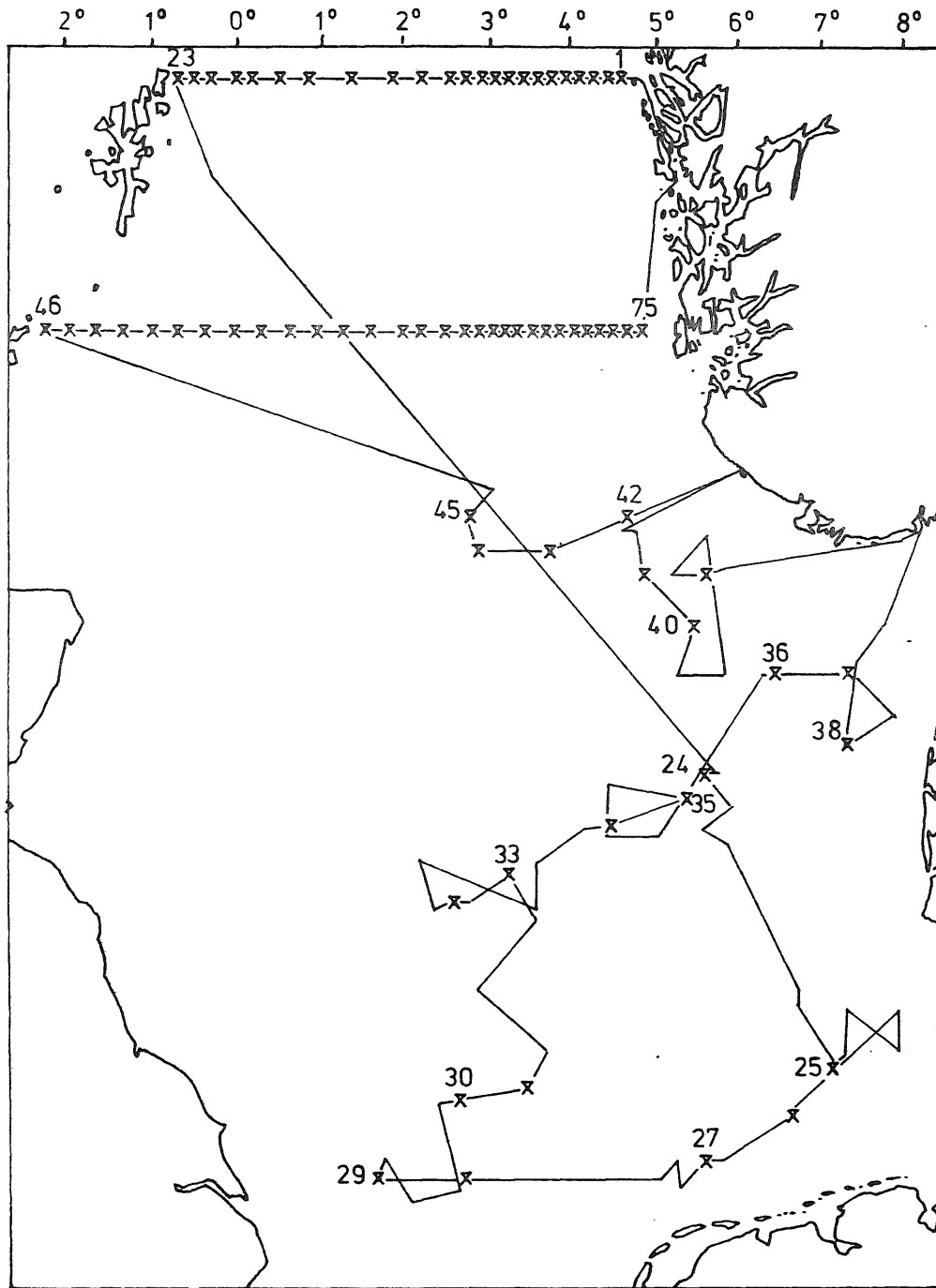

3-22 FEB. 1975 ST.NO. 1-75

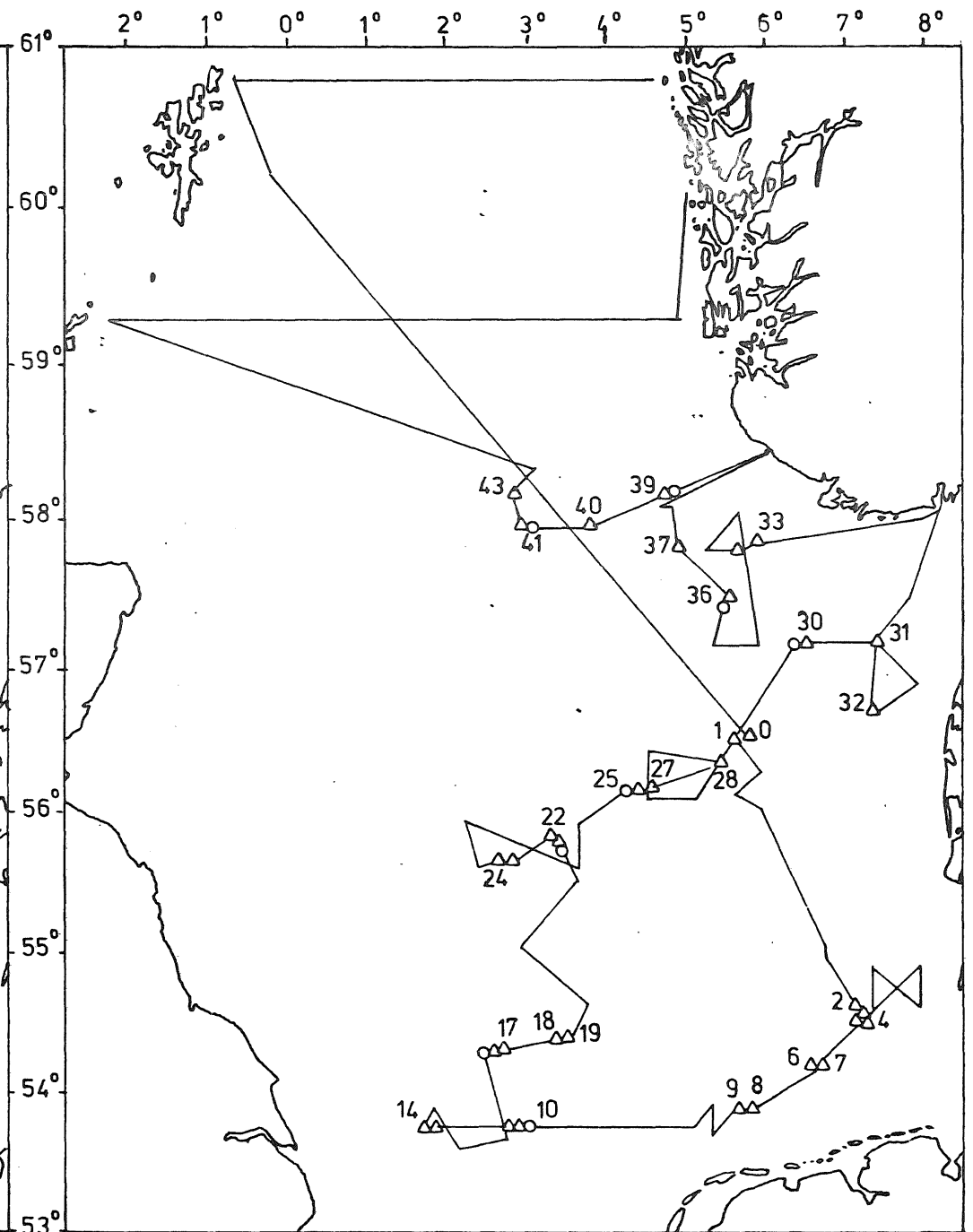

TRAWL ST. 0-43

"JOHAN HJORT"

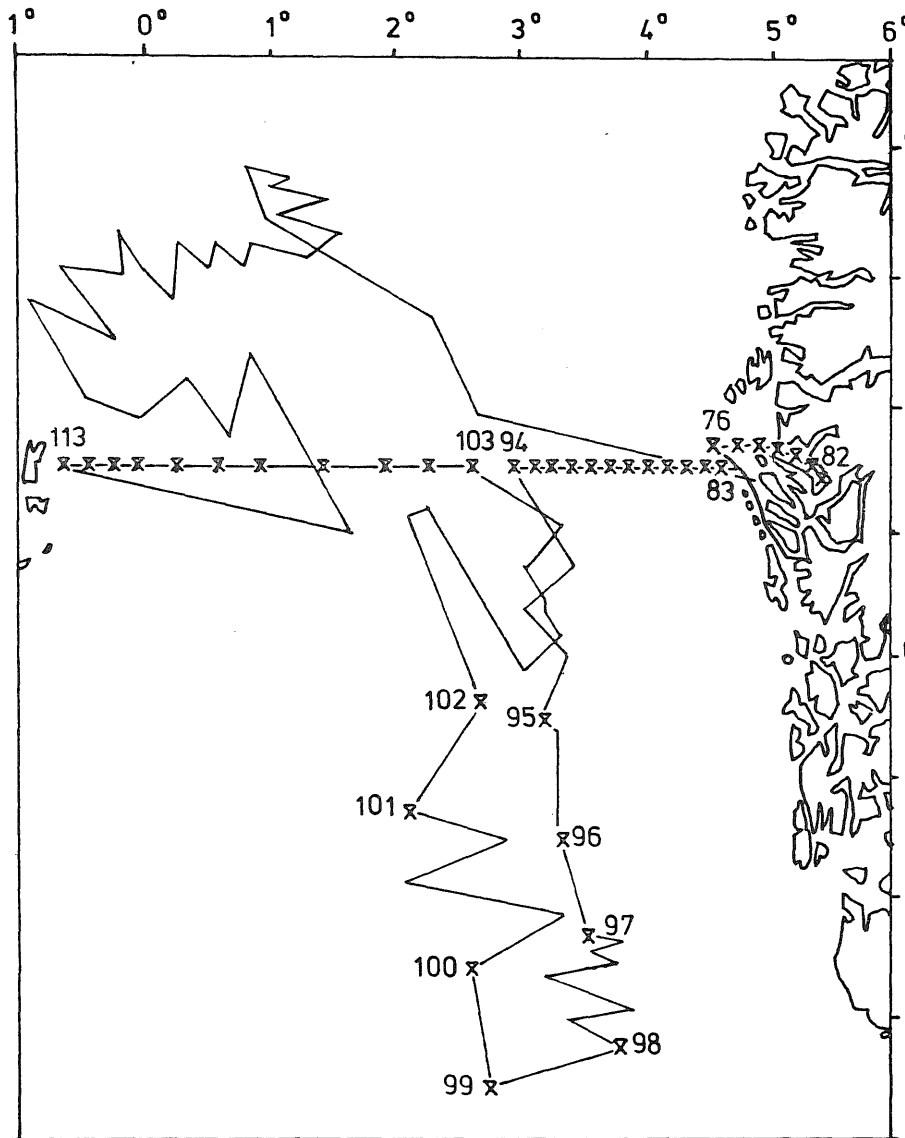

5-15 MAR. 1975 ST. NO. 76-113

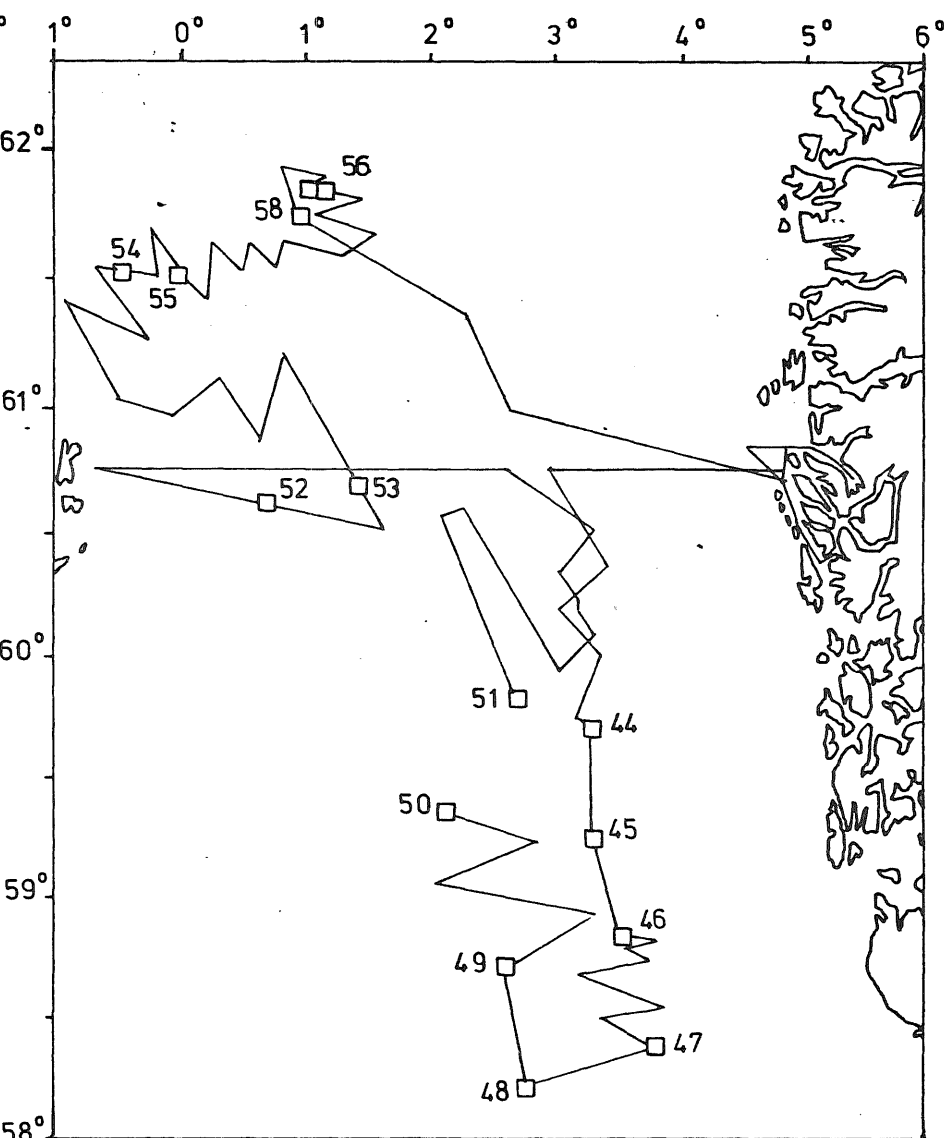

TRAWL ST. 44-58 "JOHAN HJORT"

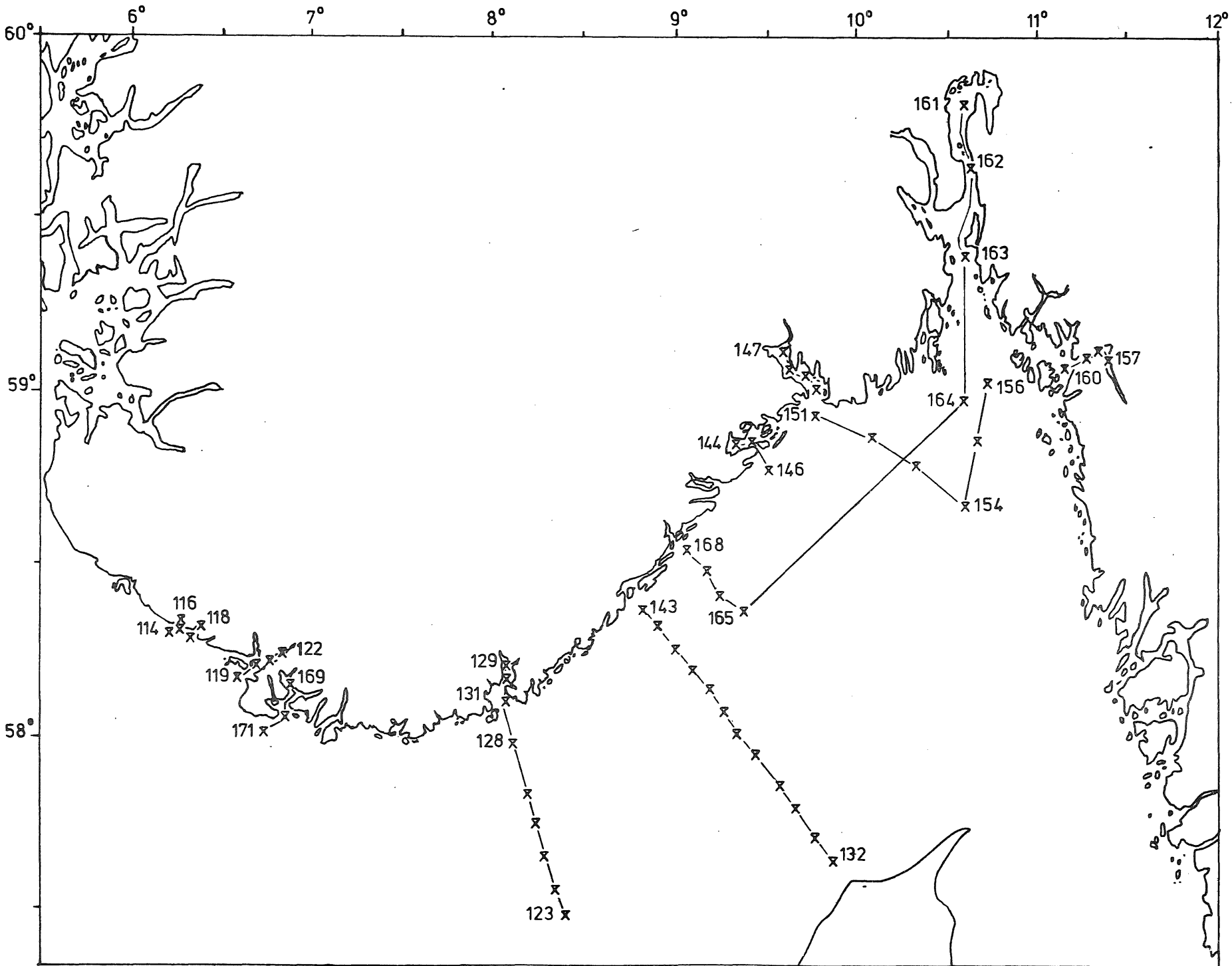

17 - 21 MAR. 1975

ST. NO. 114 - 171

"JOHAN HJORT"

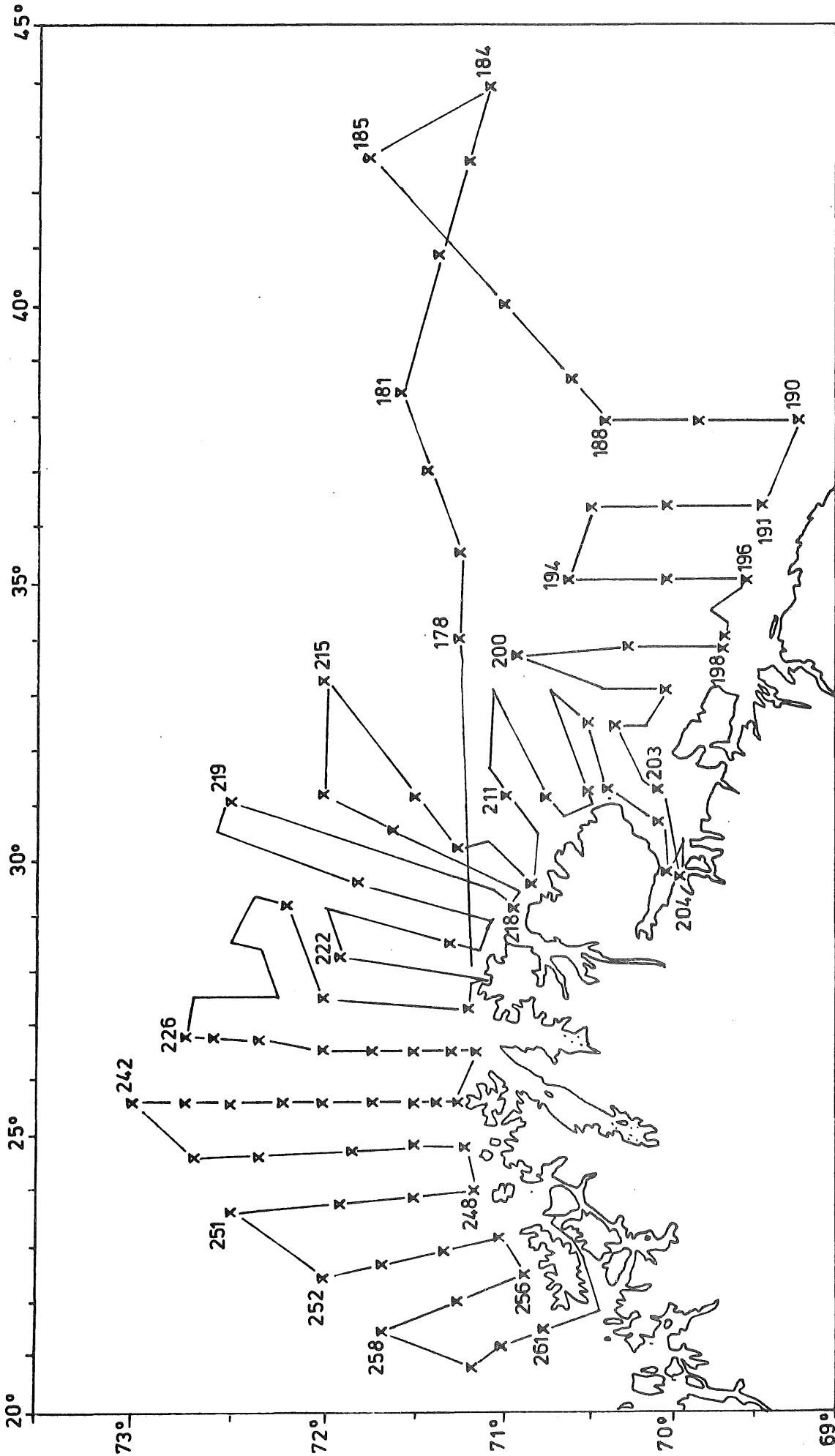

„JOHAN HJORT“

ST. NO. 178 - 261

23 APR. - 7 MAY 1975

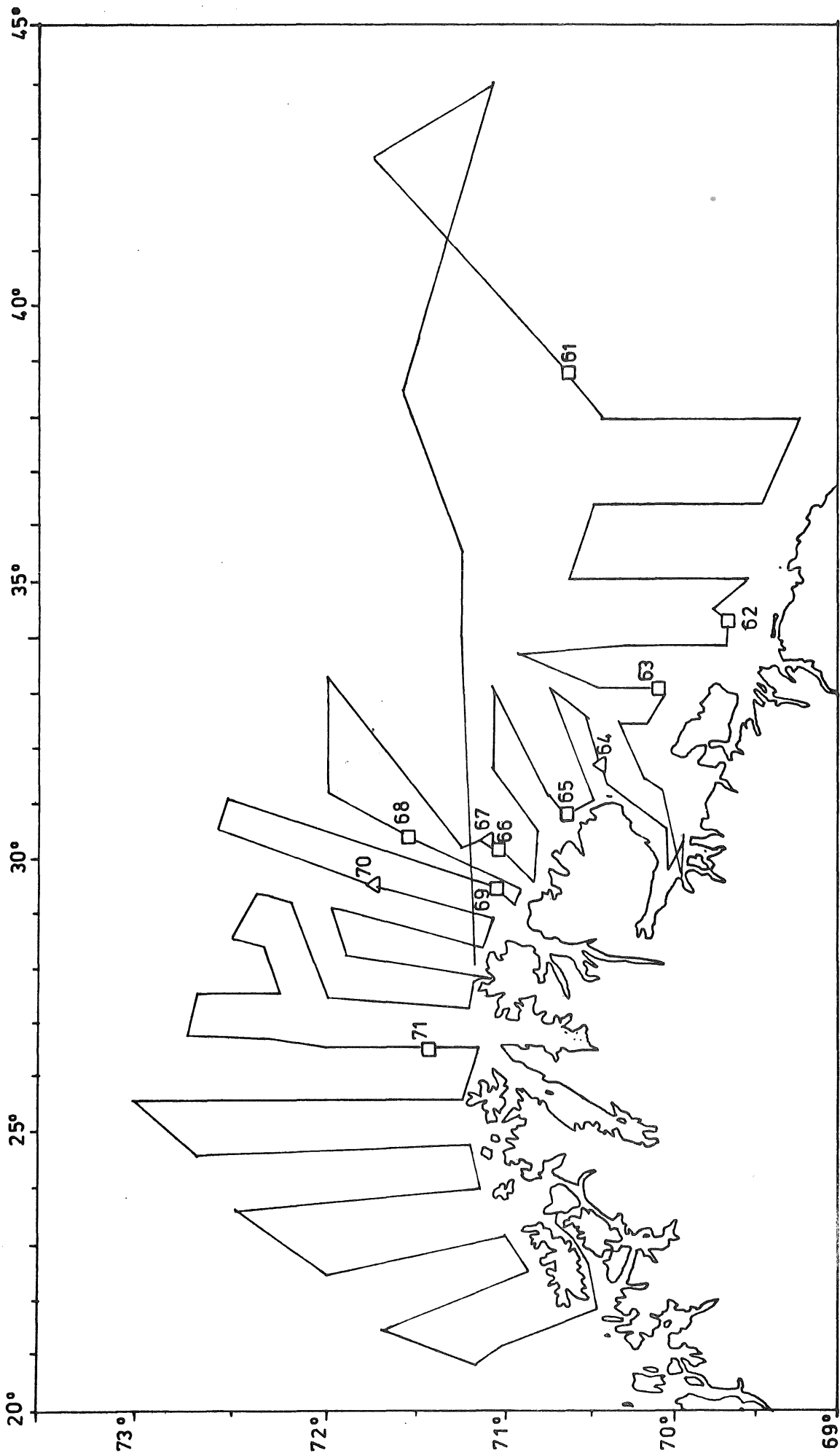

..JOHAN HJORT"

TRAWL ST. 61-71

23 APR. - 7 MAY 1975

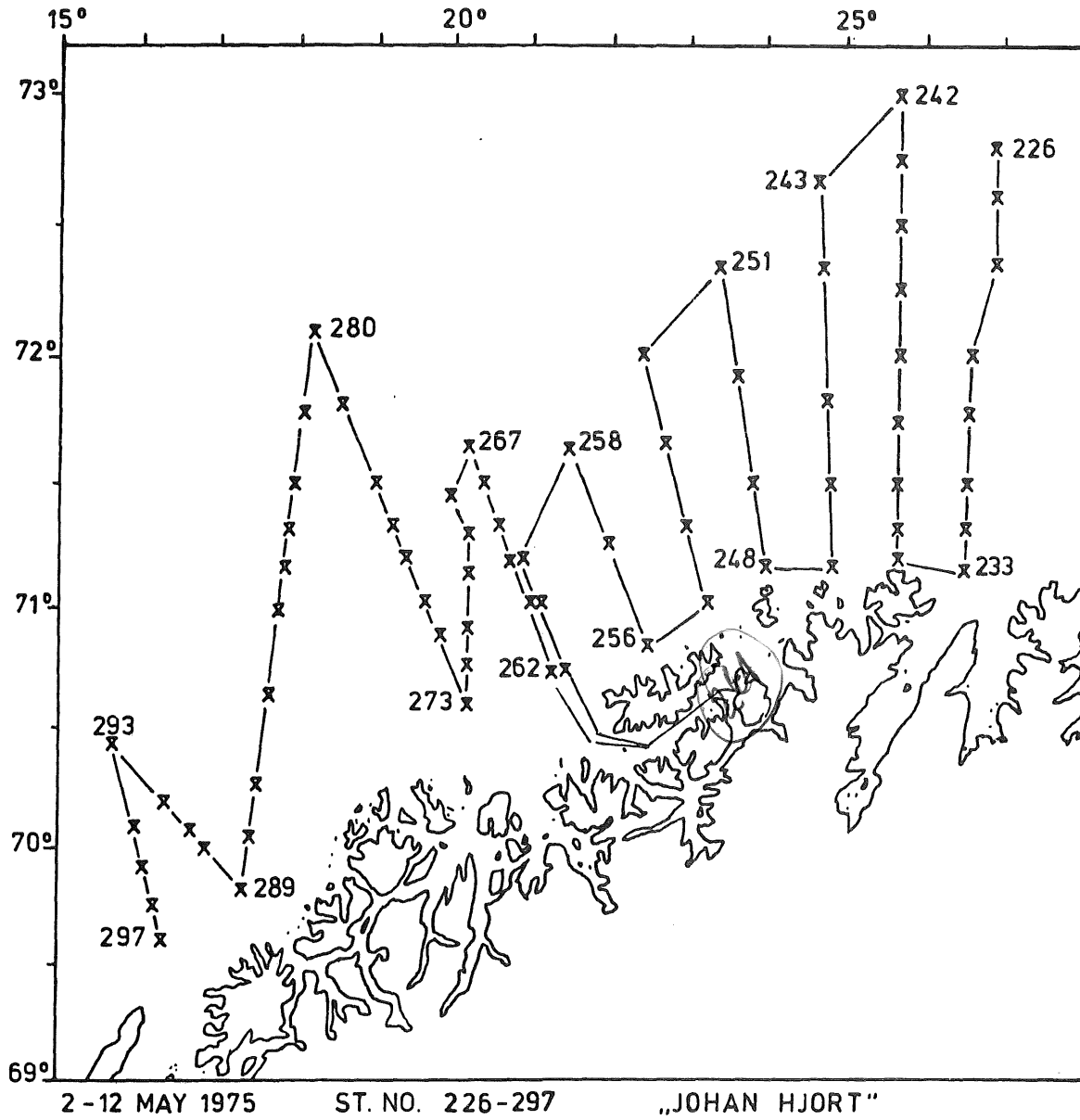

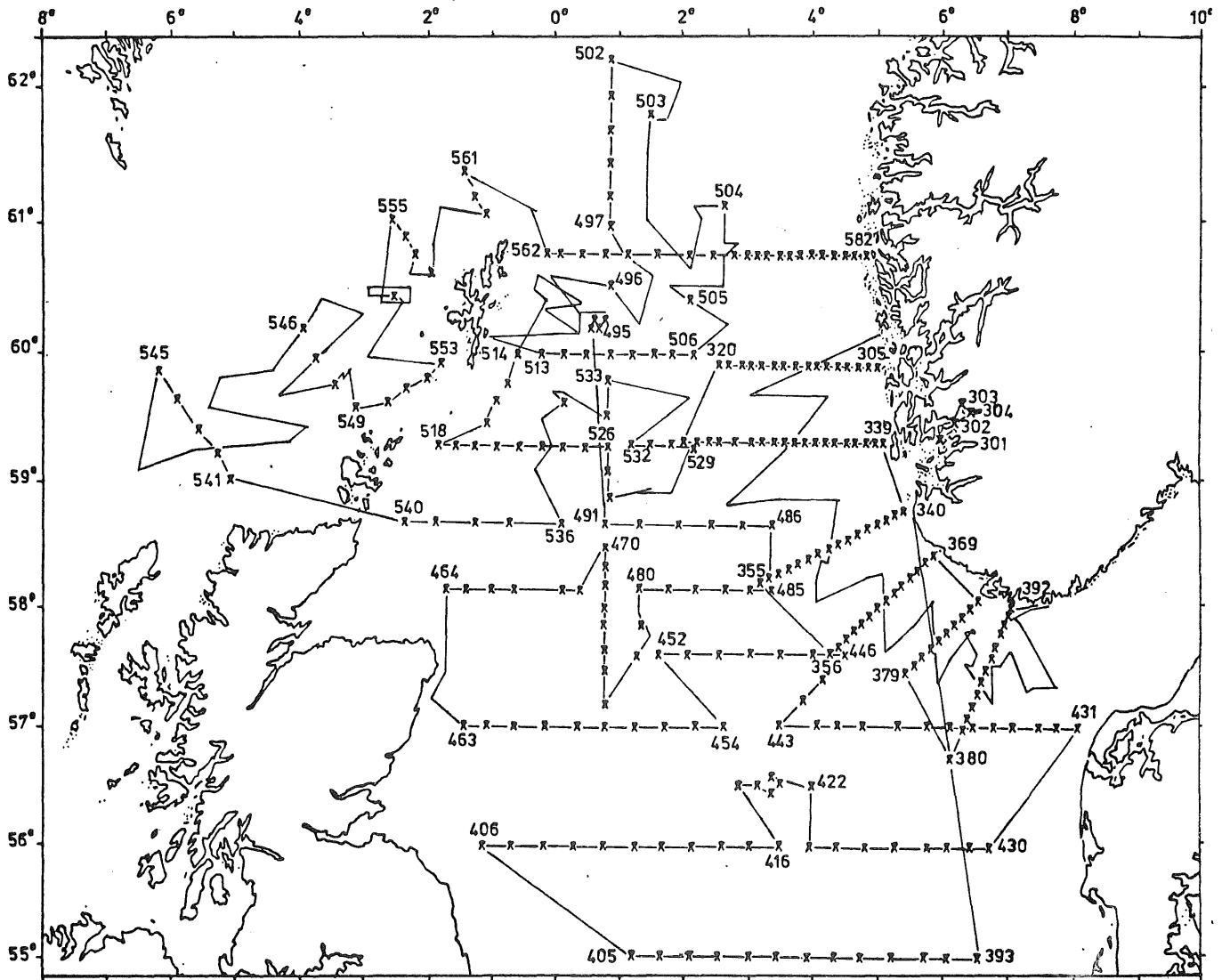

26 MAY - 11 JUL. 1975

ST.NO. 301 - 582

"JOHAN HJORT"

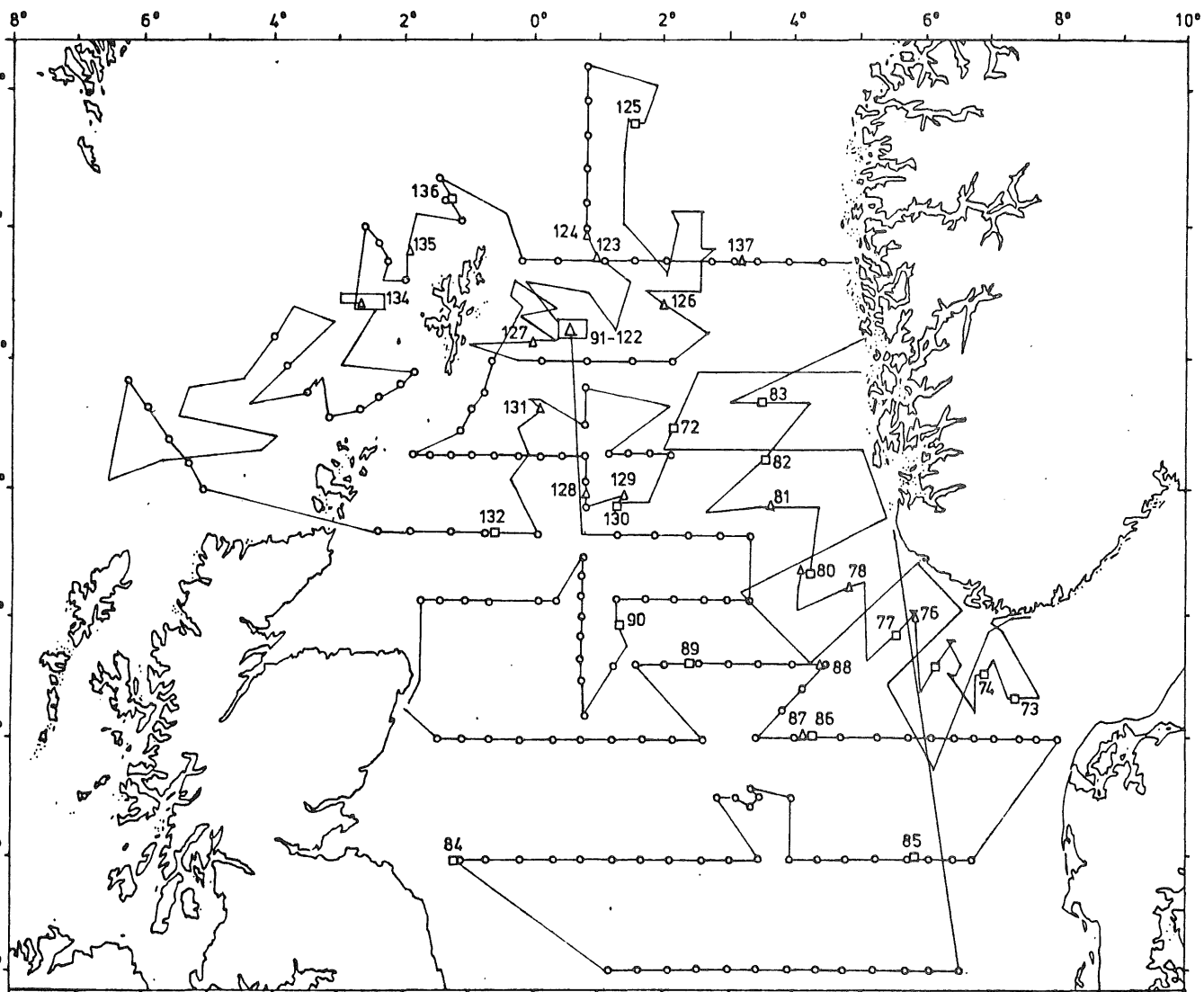

26 MAY-11 JUL. 1975 TRAWL ST. NO. 73-137 ○ CLARKE 161 STATIONS „JOHAN HJORT“

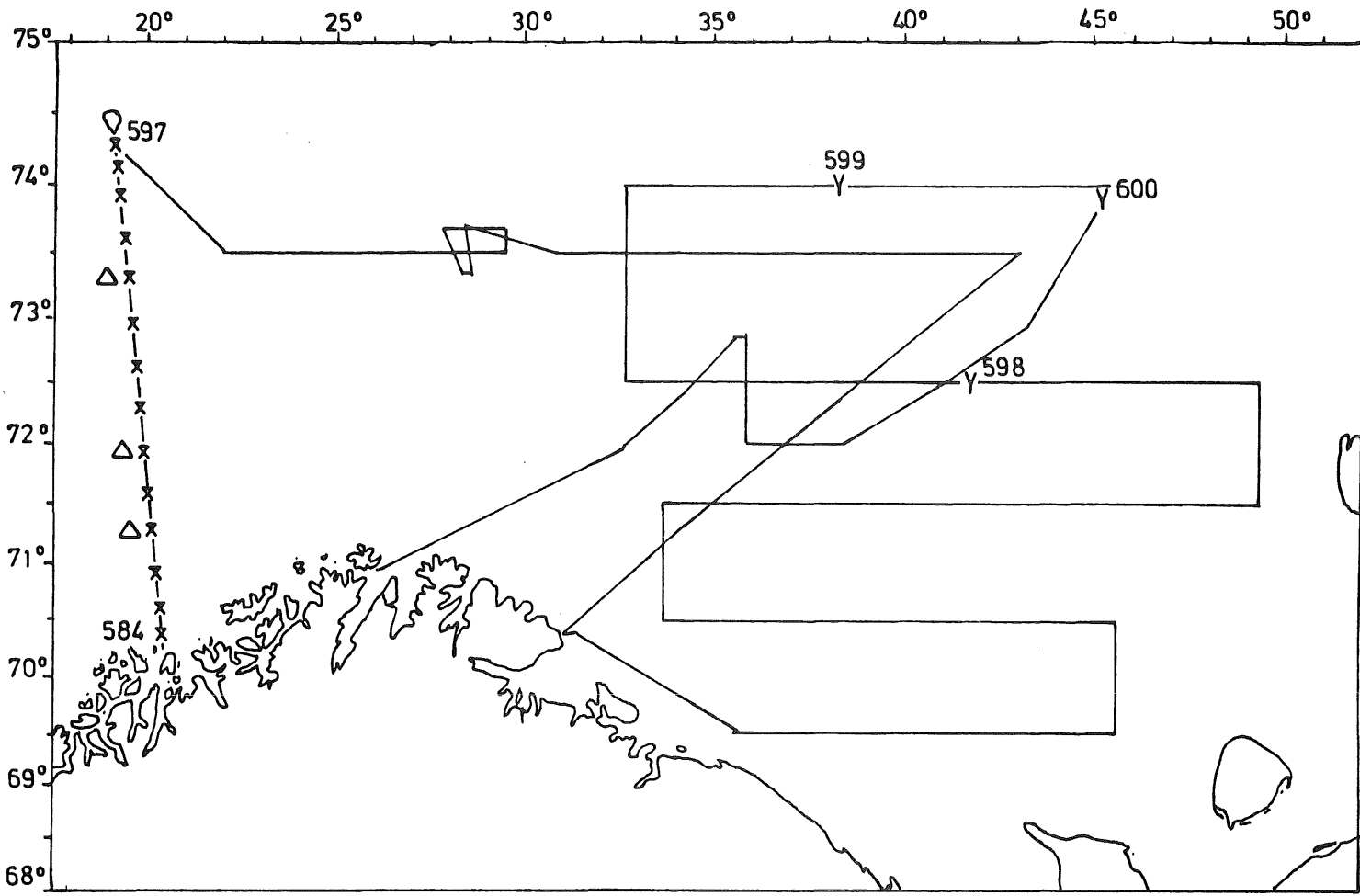

19 AUG. - 7 SEP. 1975 ST. NO. 584 - 600 „Johan Hjort“

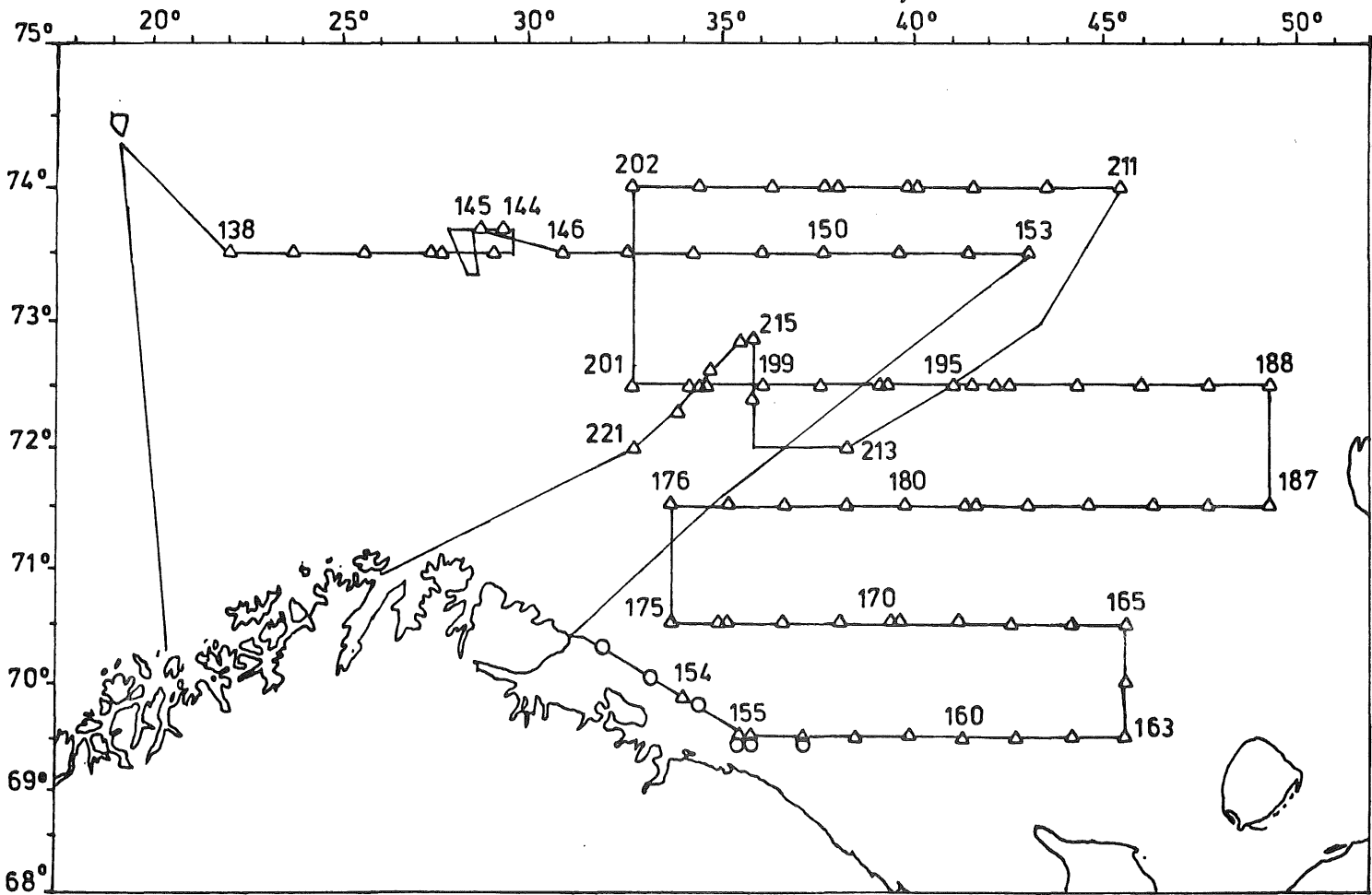

19 AUG. - 7 SEP. 1975 TRAWL ST. 138 - 221 „JOHAN HJORT“

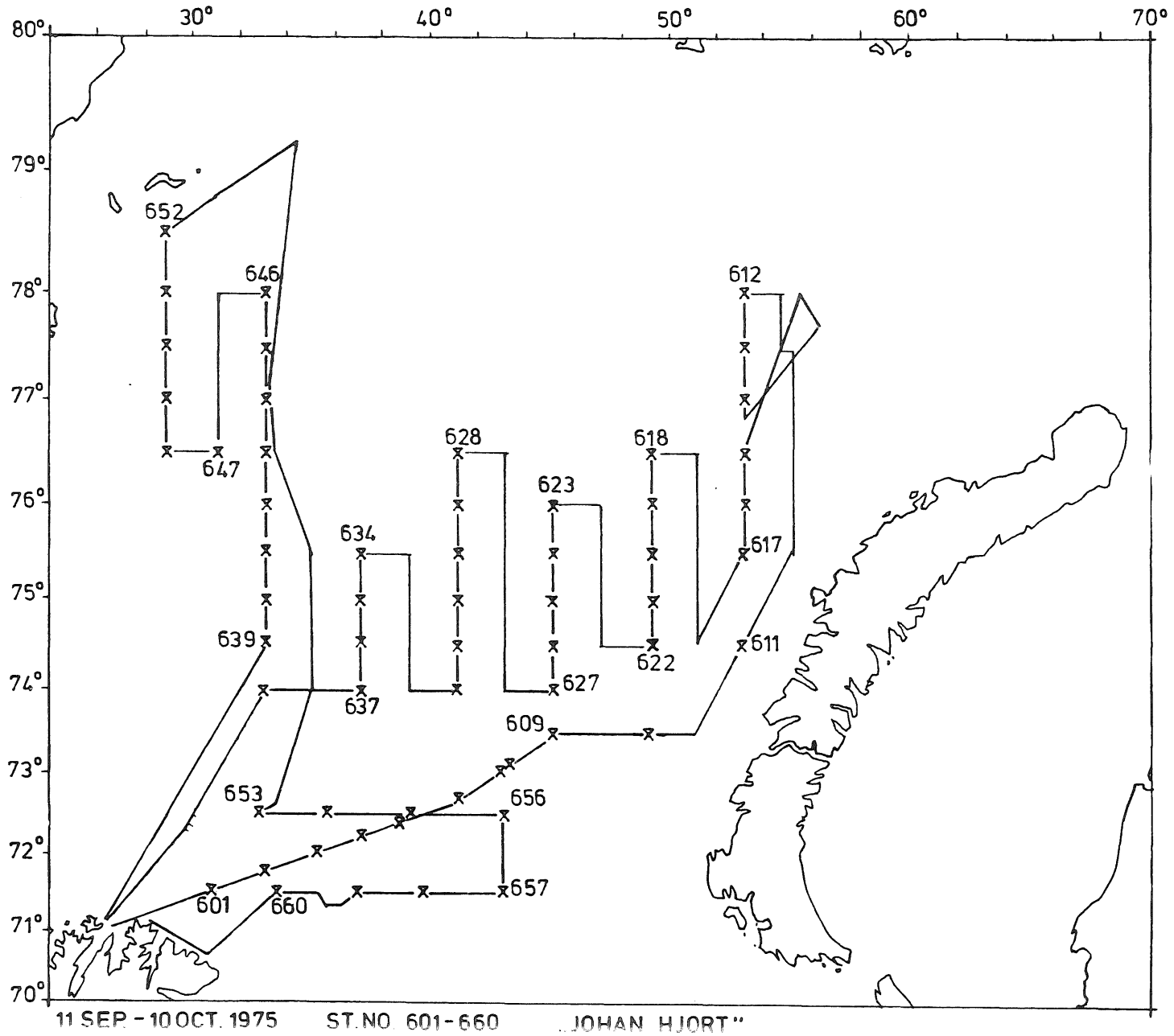

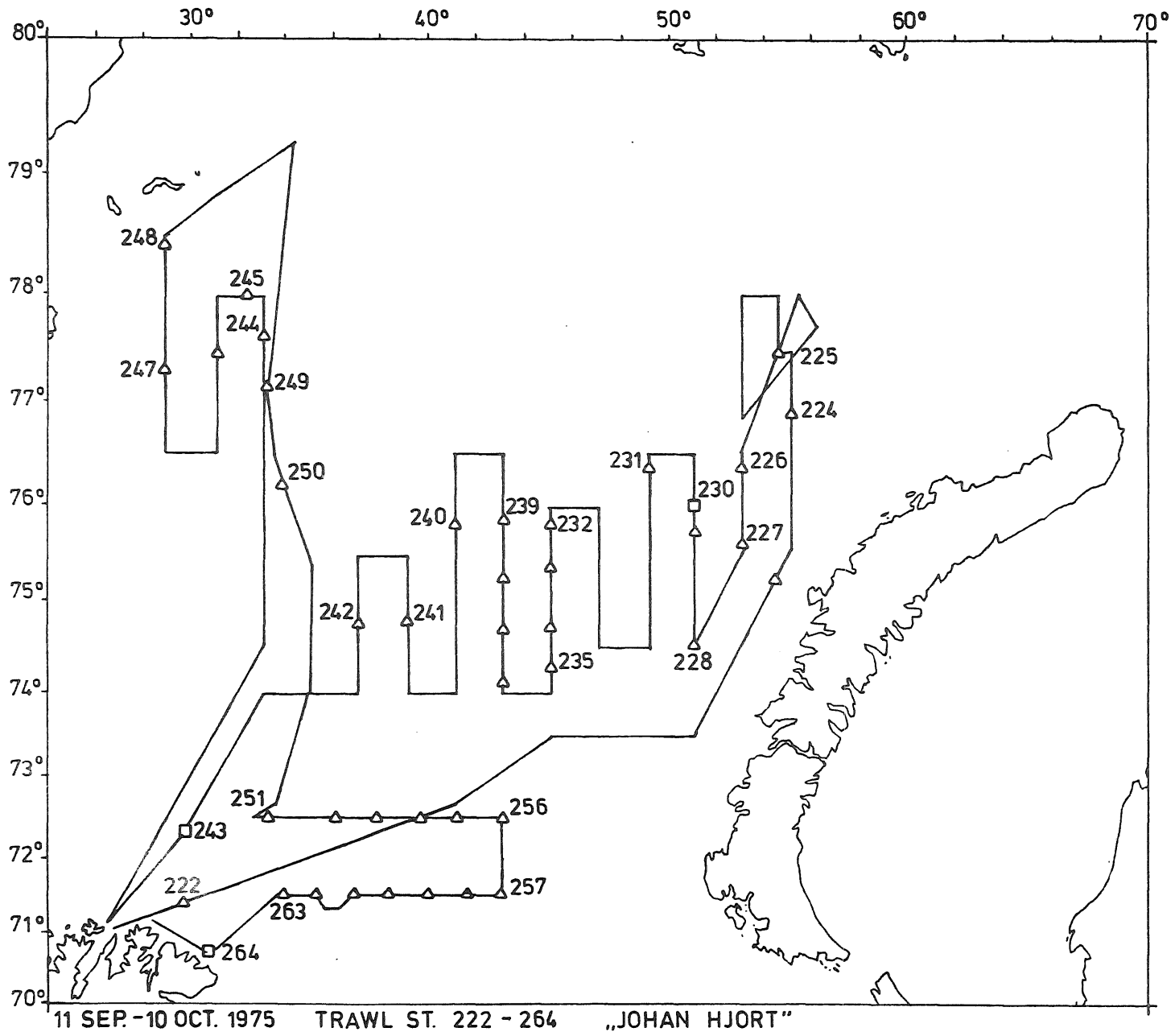

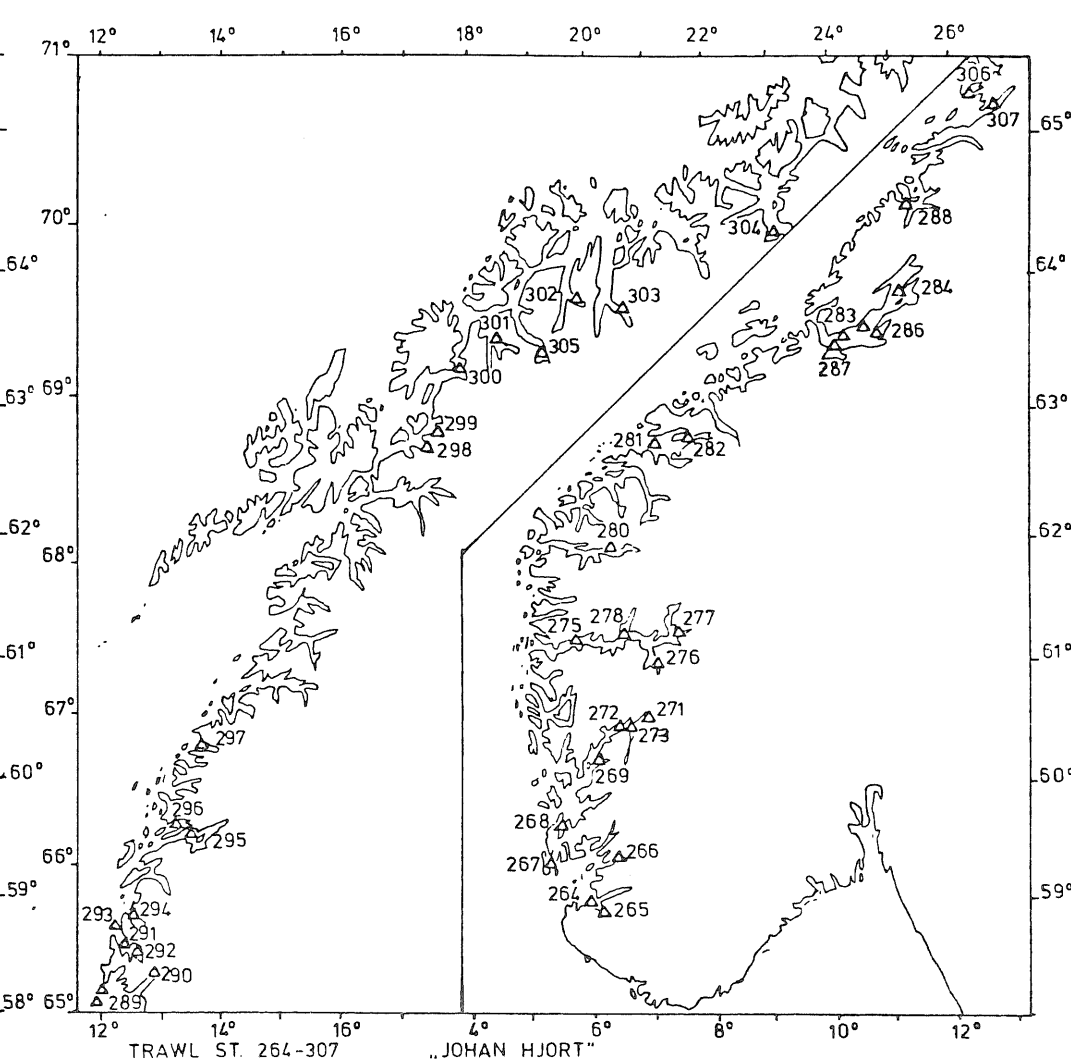
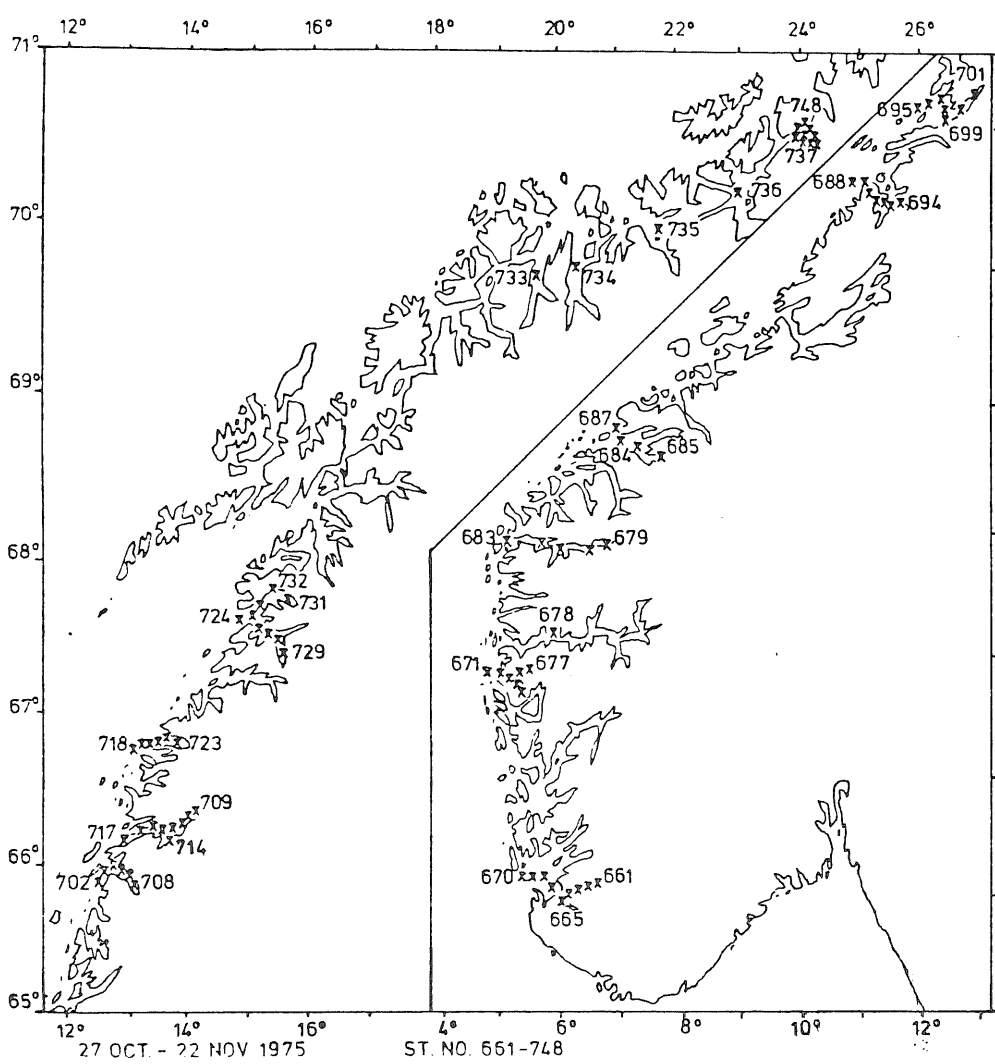

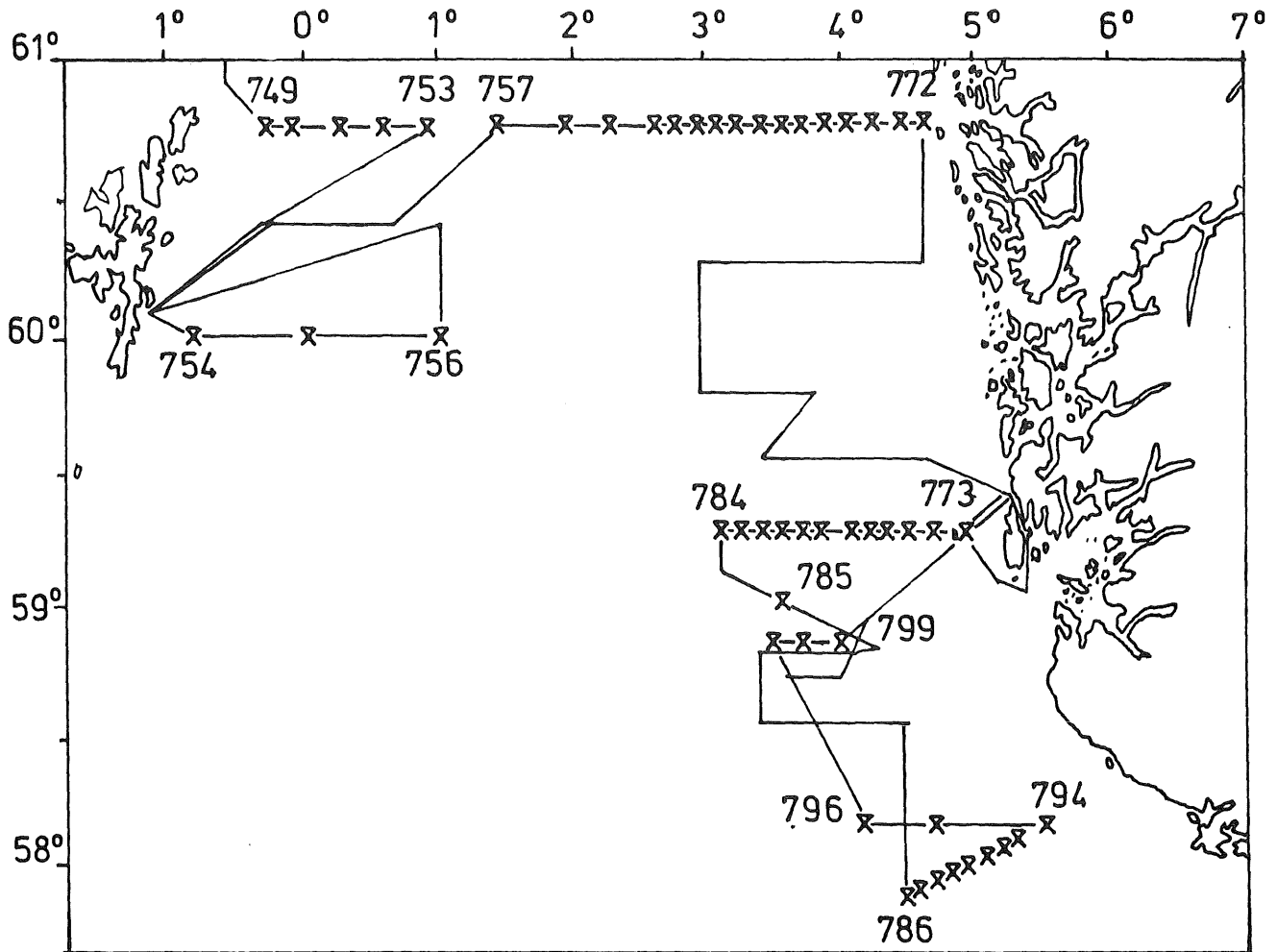

1-15 DEC. 1975 ST. NO. 749-799 „JOHAN HJORT”

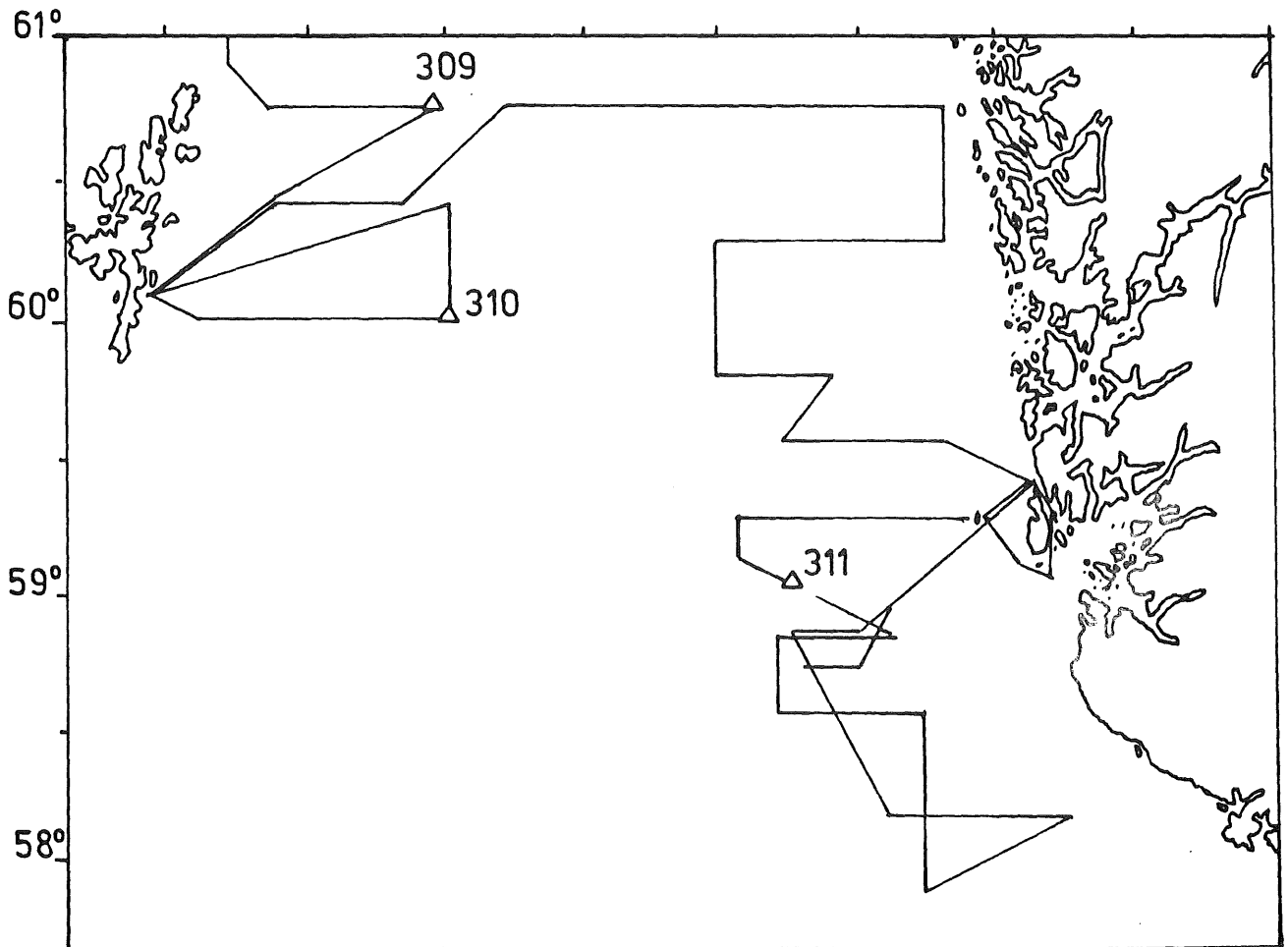

TRAWL ST. 309-311

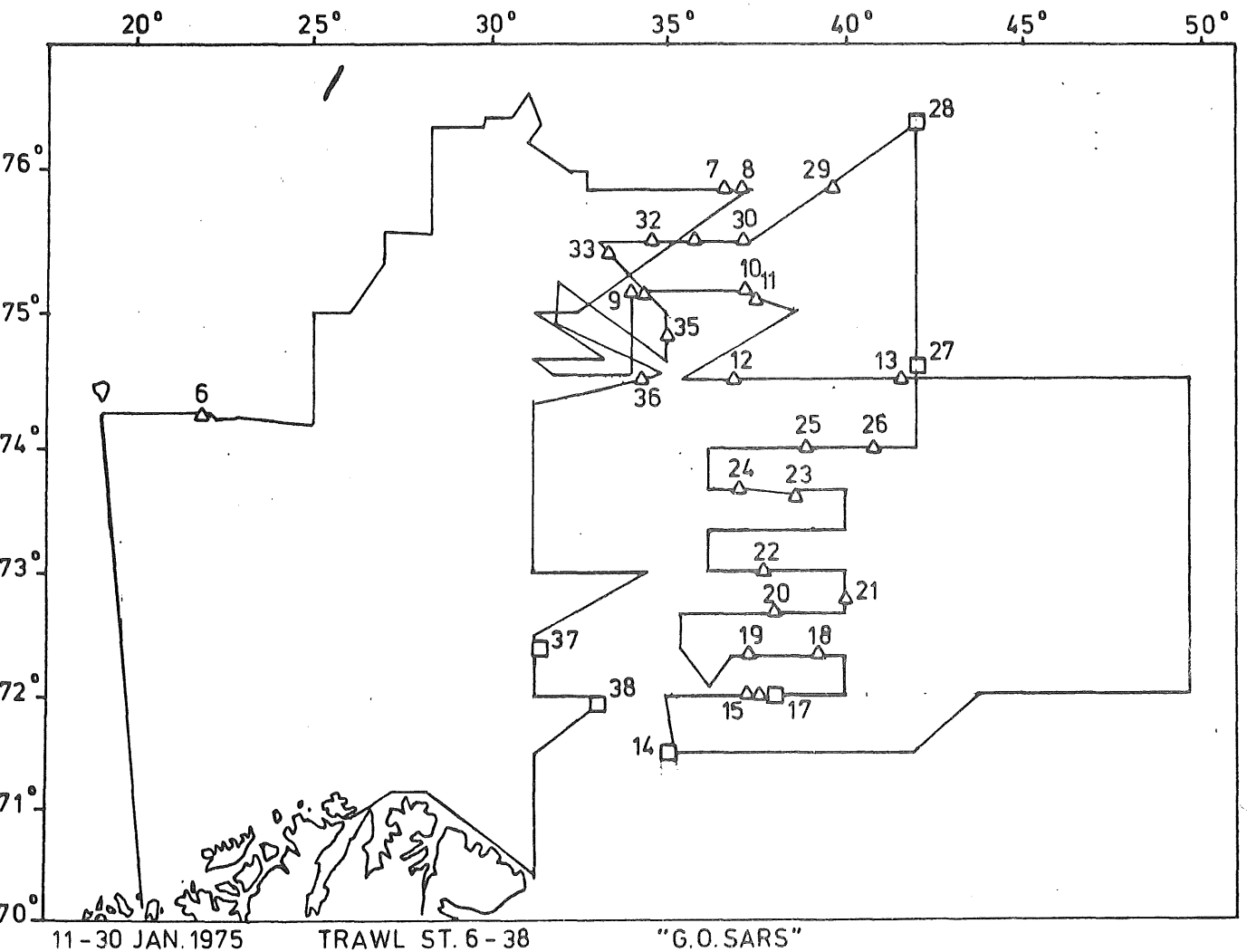
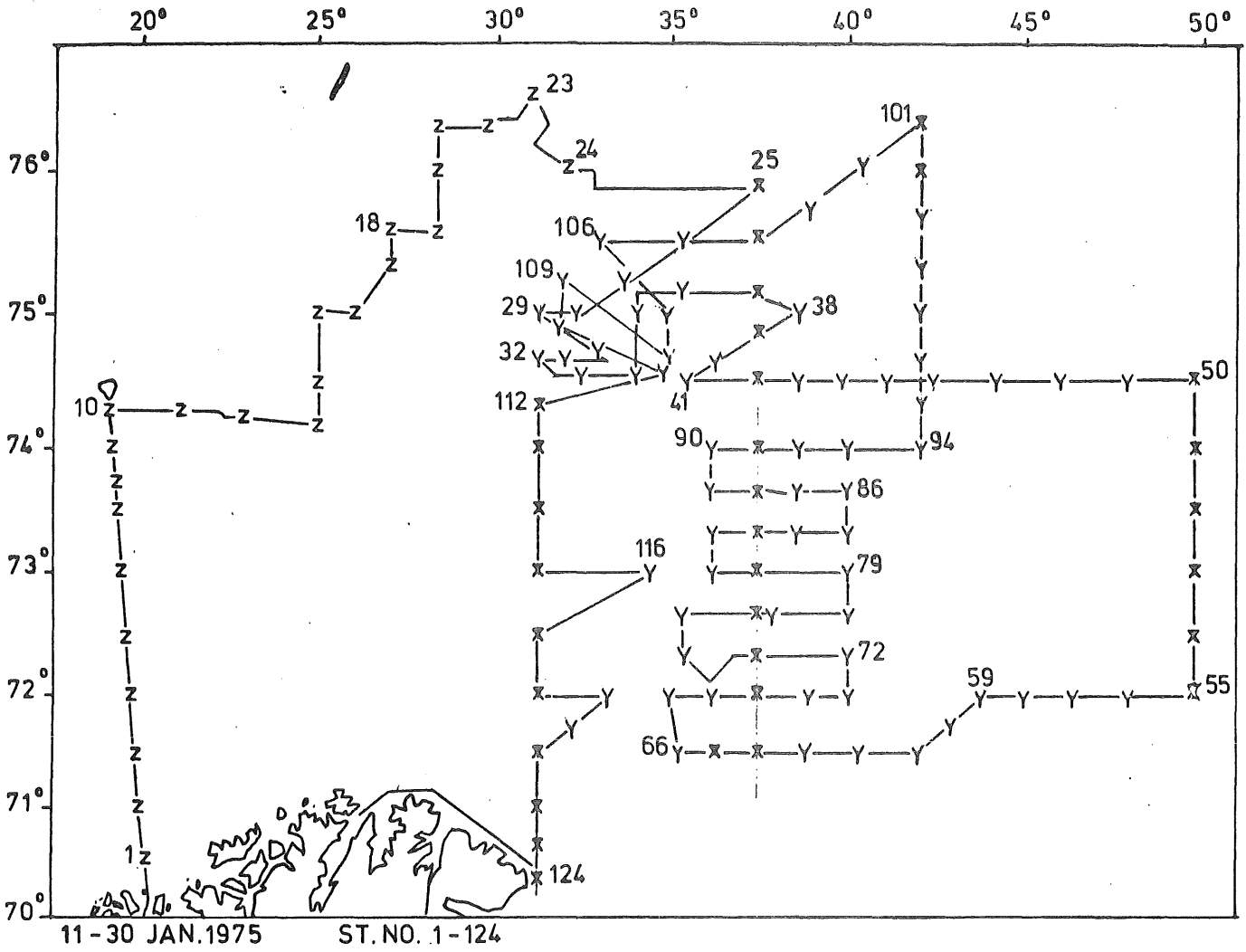

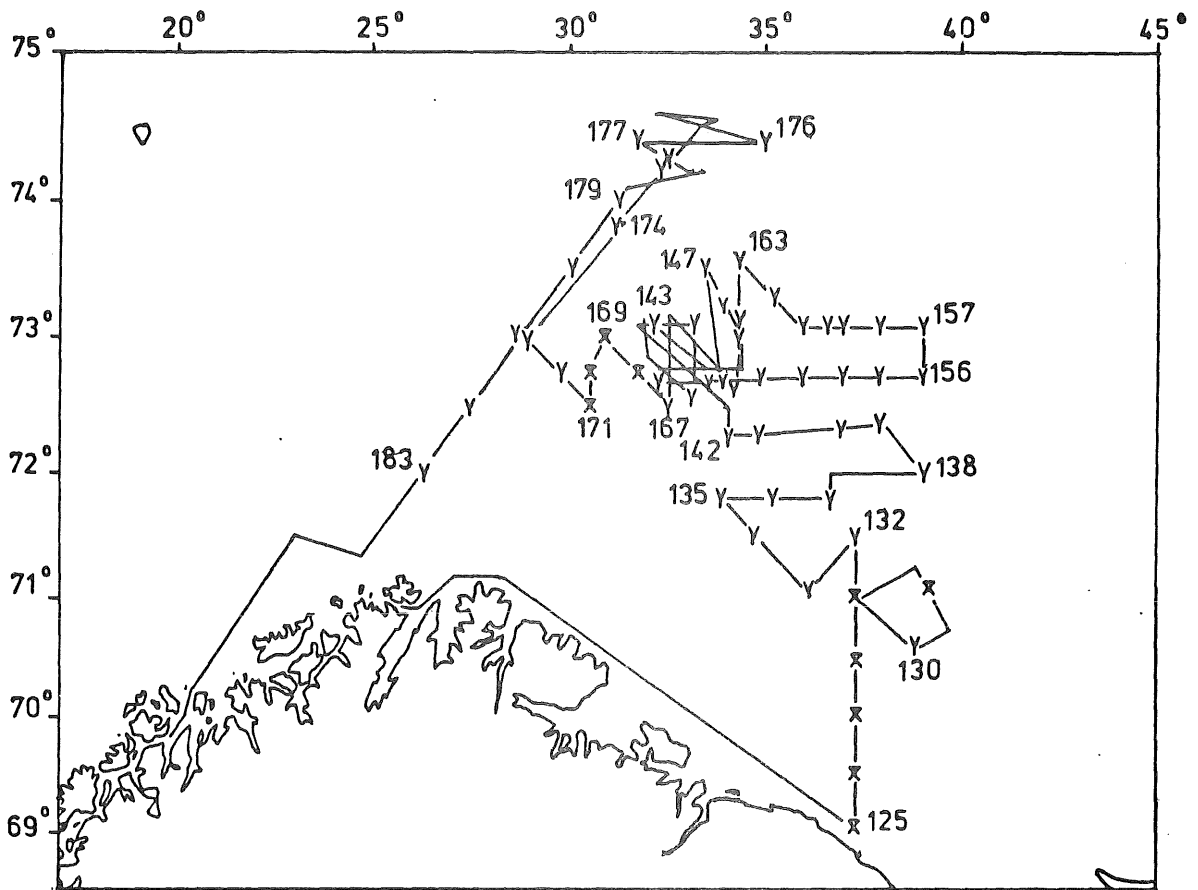

2-15 FEB. 1975 ST. NO. 125 - 183

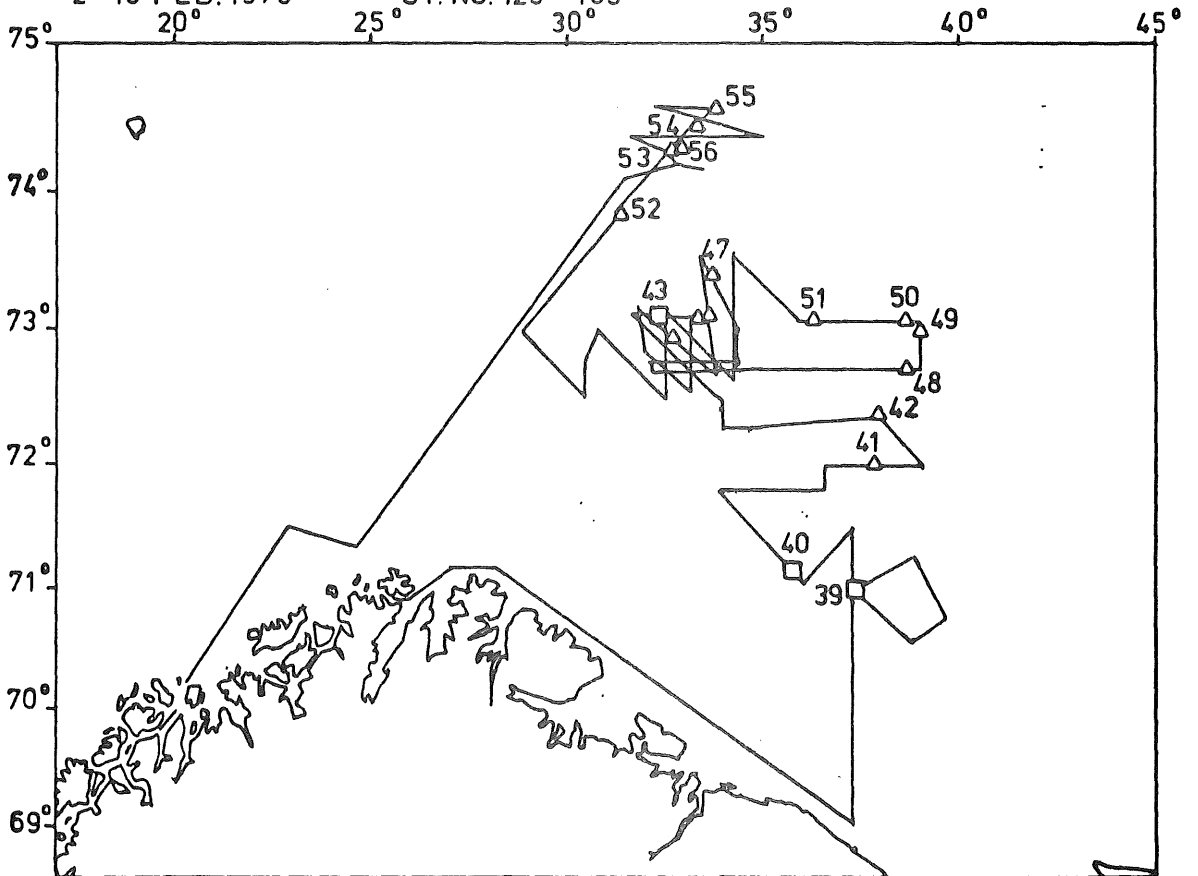

2-15 FEB. 1975 TRAWL ST. 39-56 "G.O.SARS"

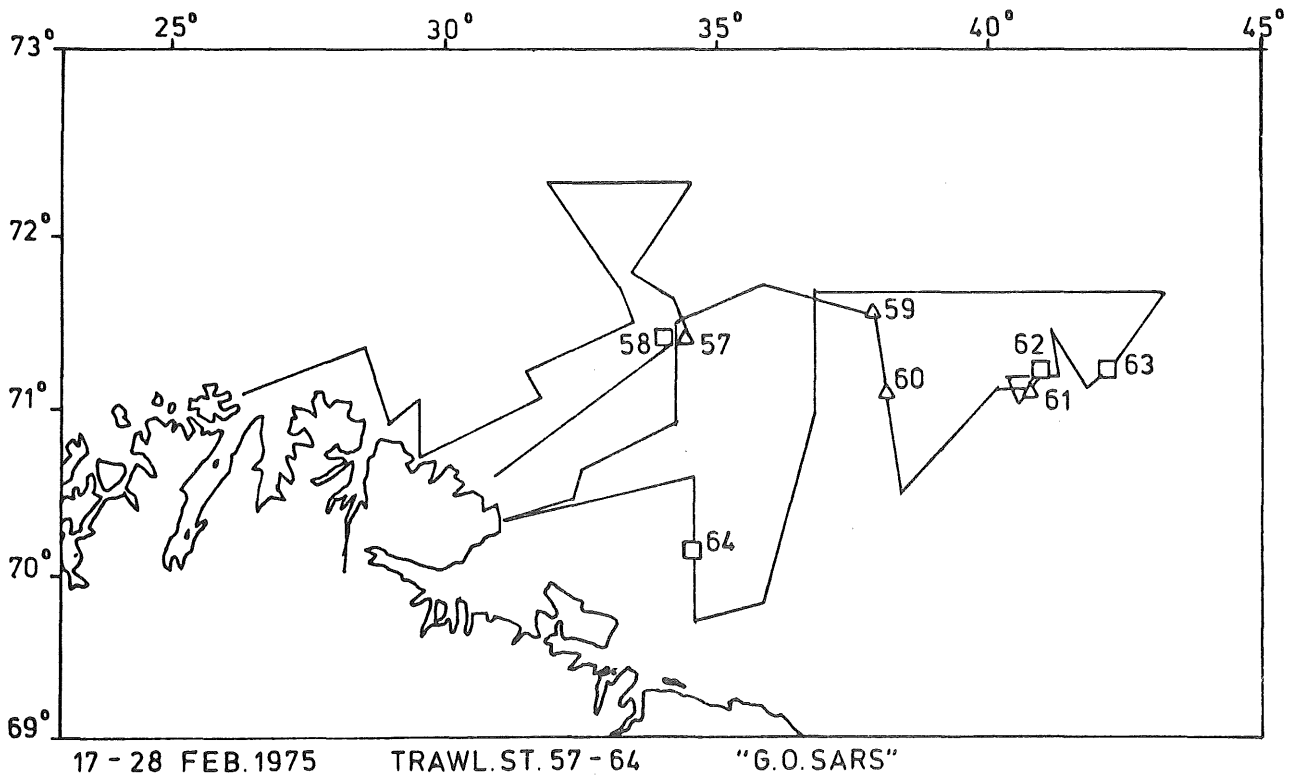
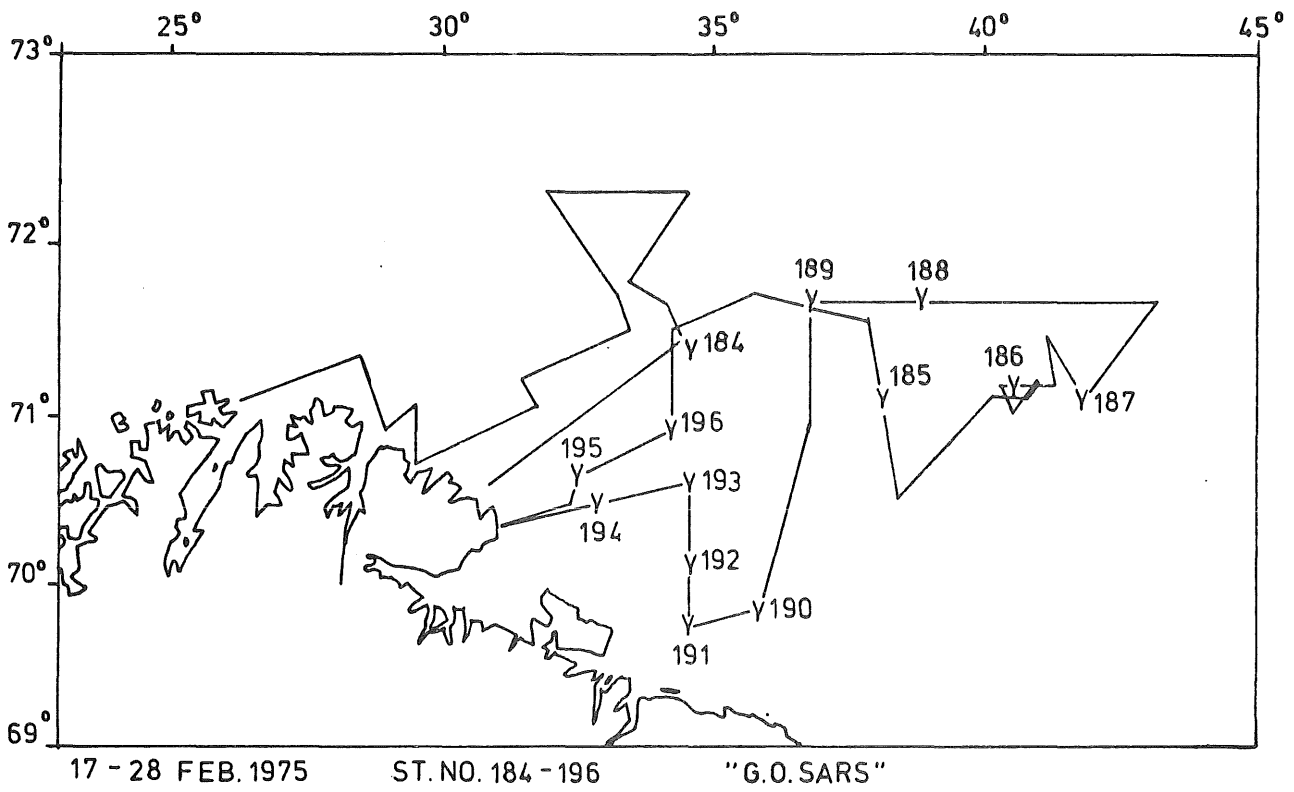

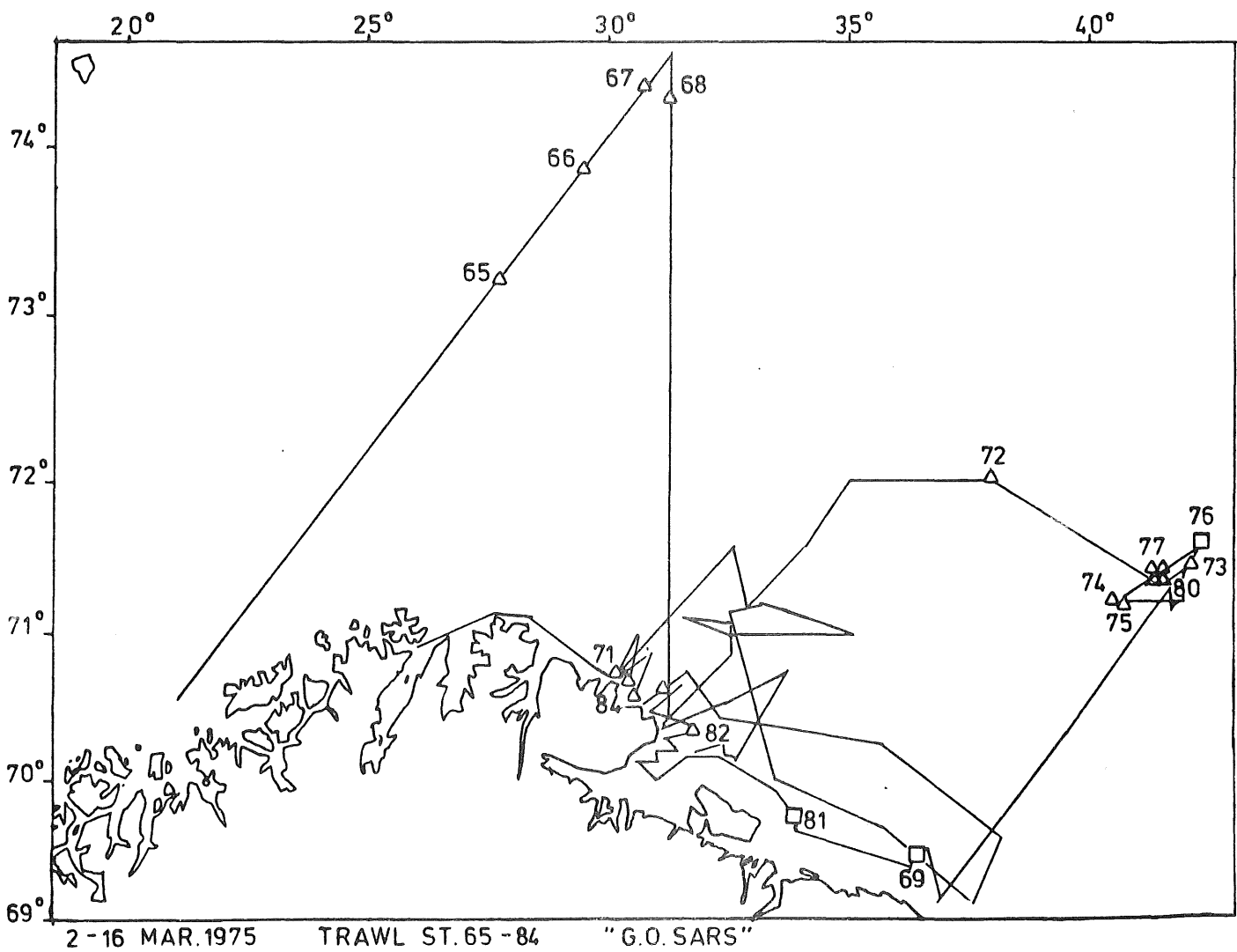
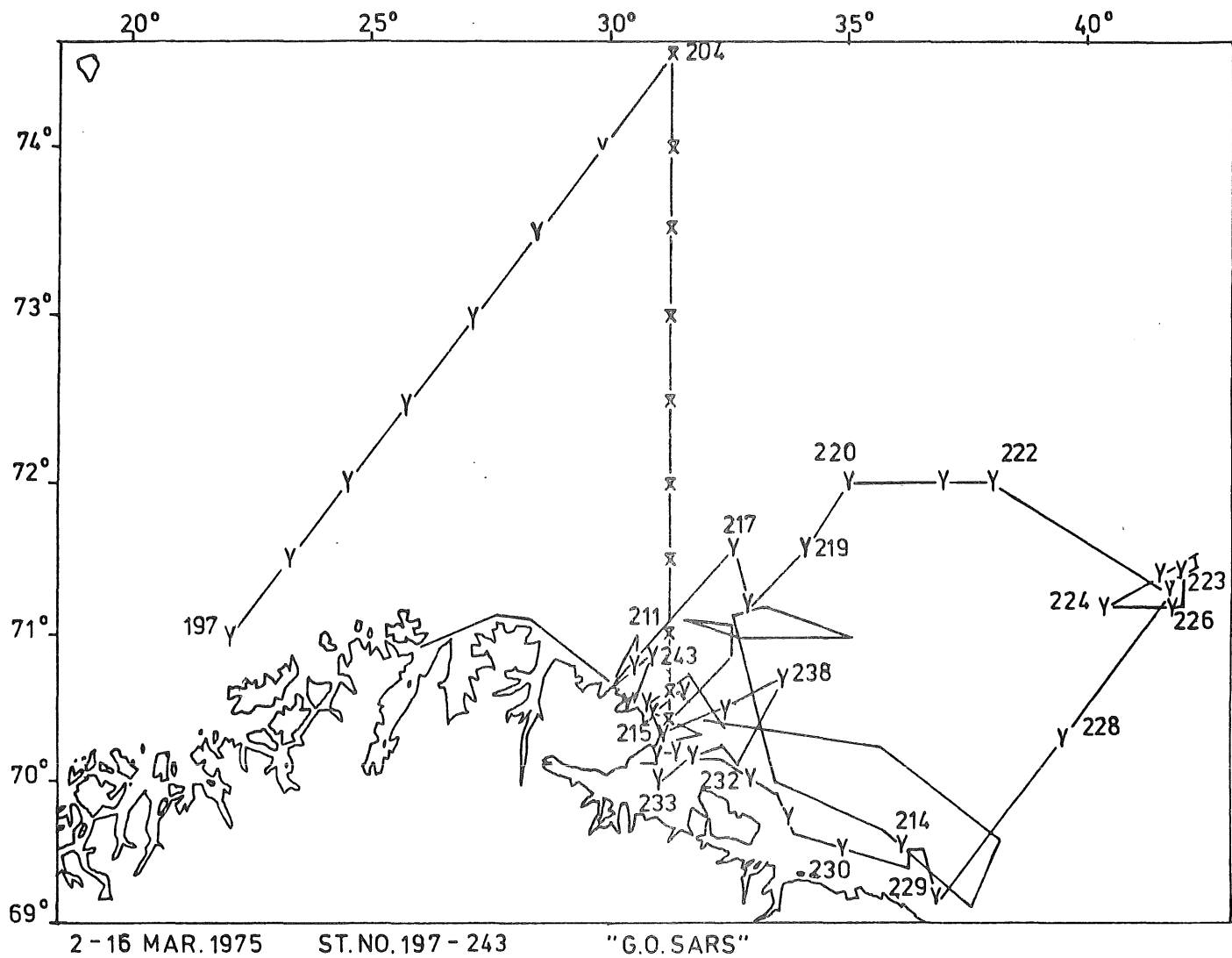

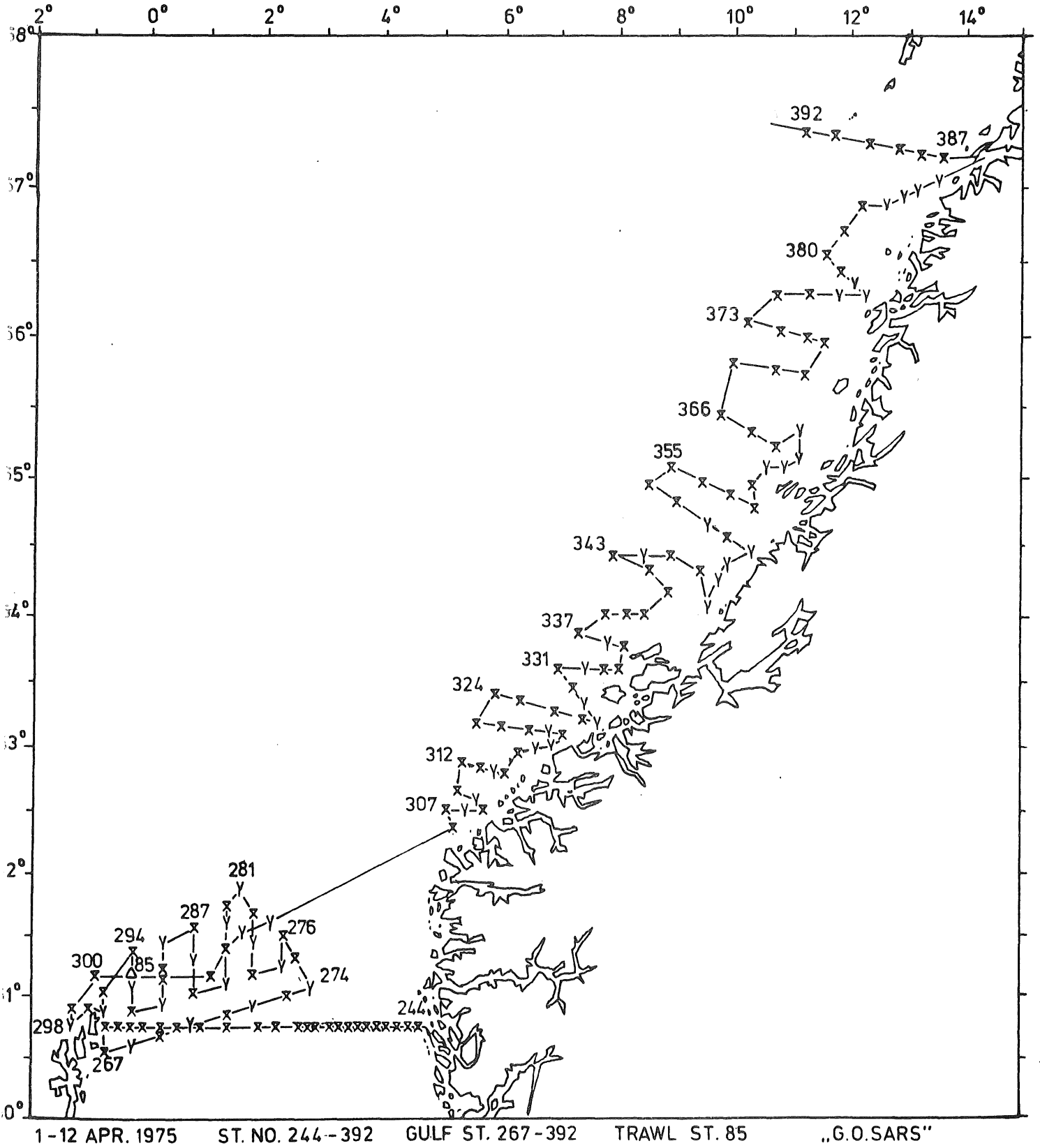

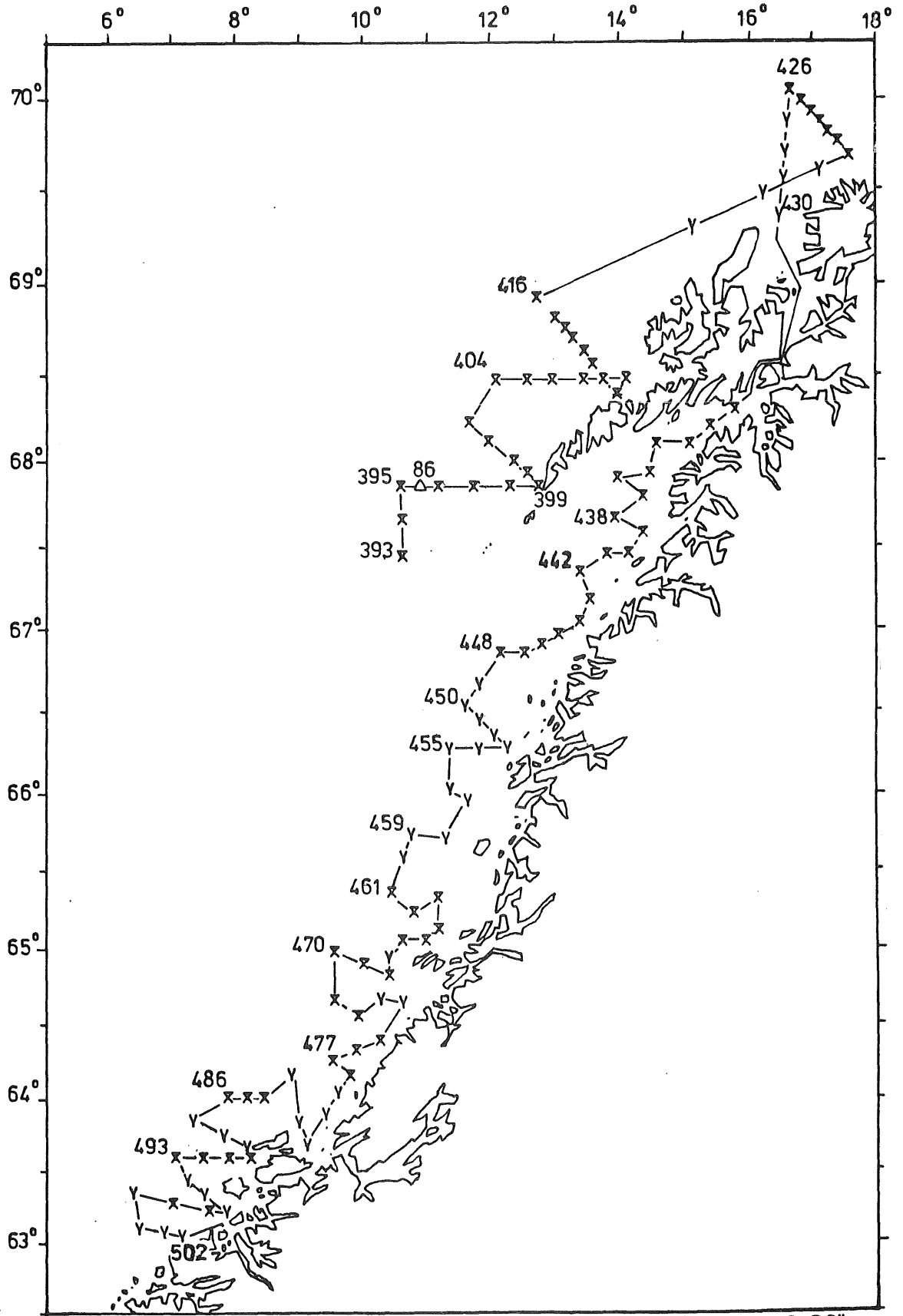

12-18 APR. 1975 ST. NO. + GULF ST. 393-502 TRAWL ST. 86 „G.O.SARS”

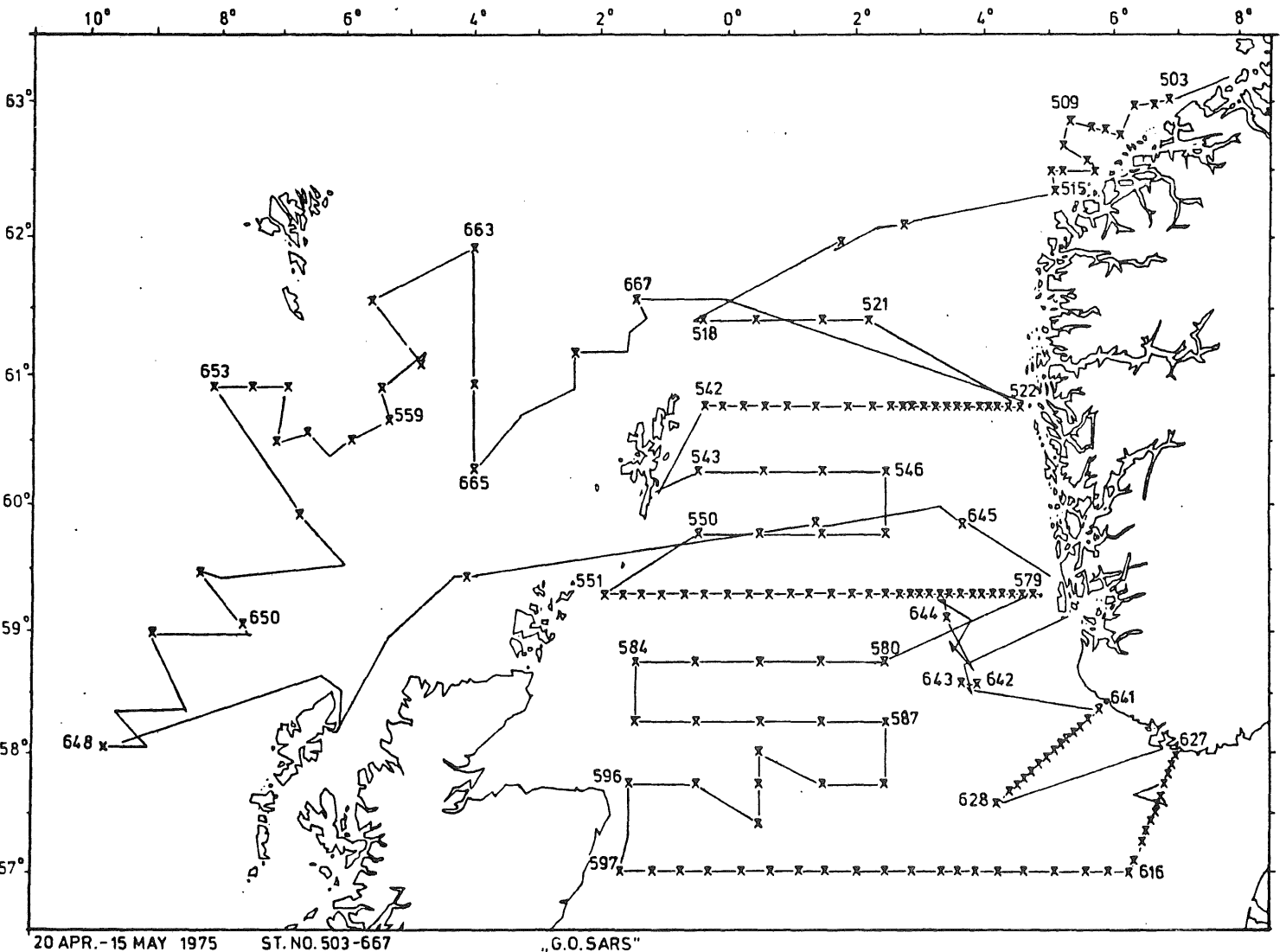

20 APR. - 15 MAY 1975

ST. NO. 503-667

„G.O. SARS“

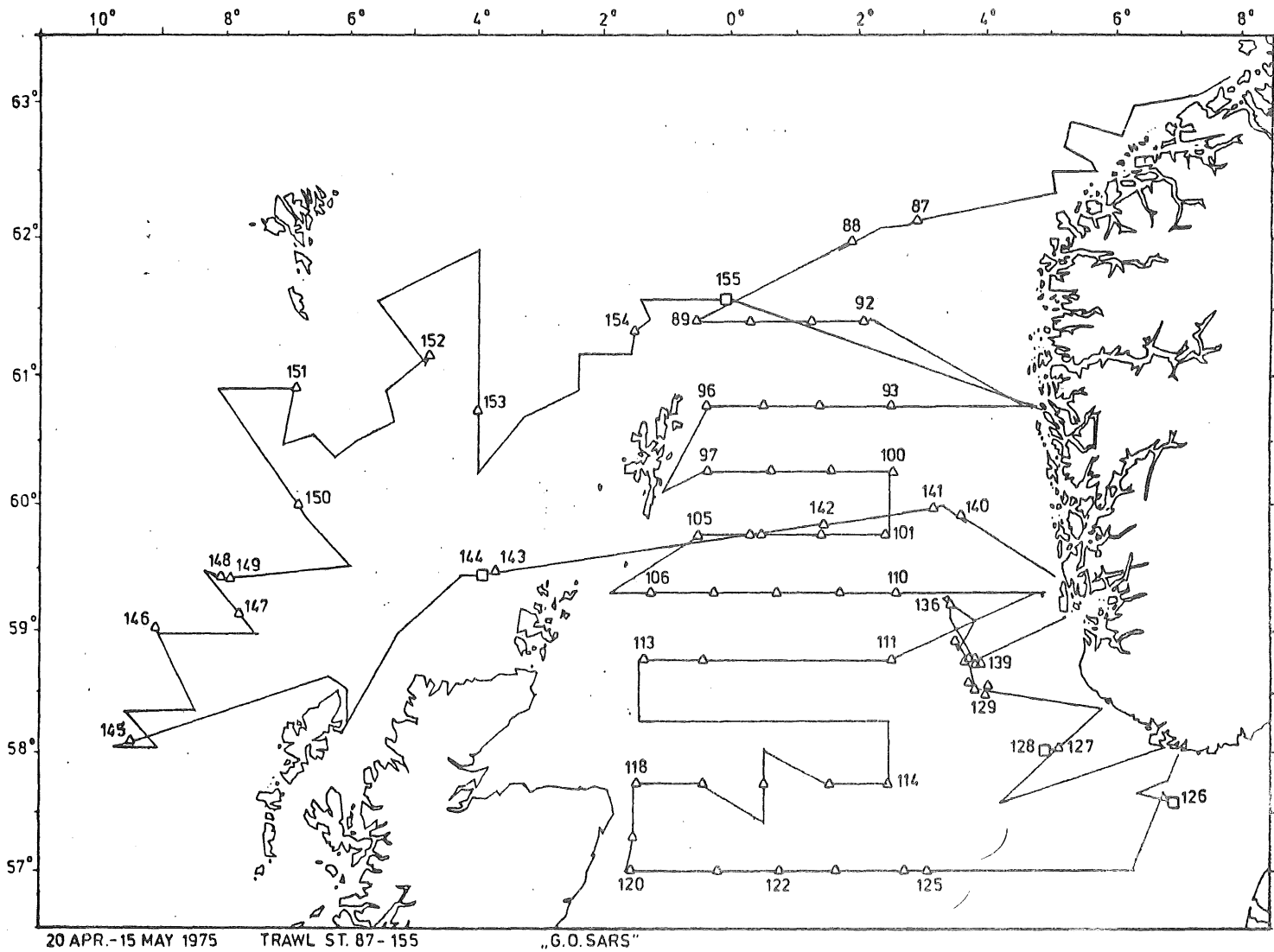

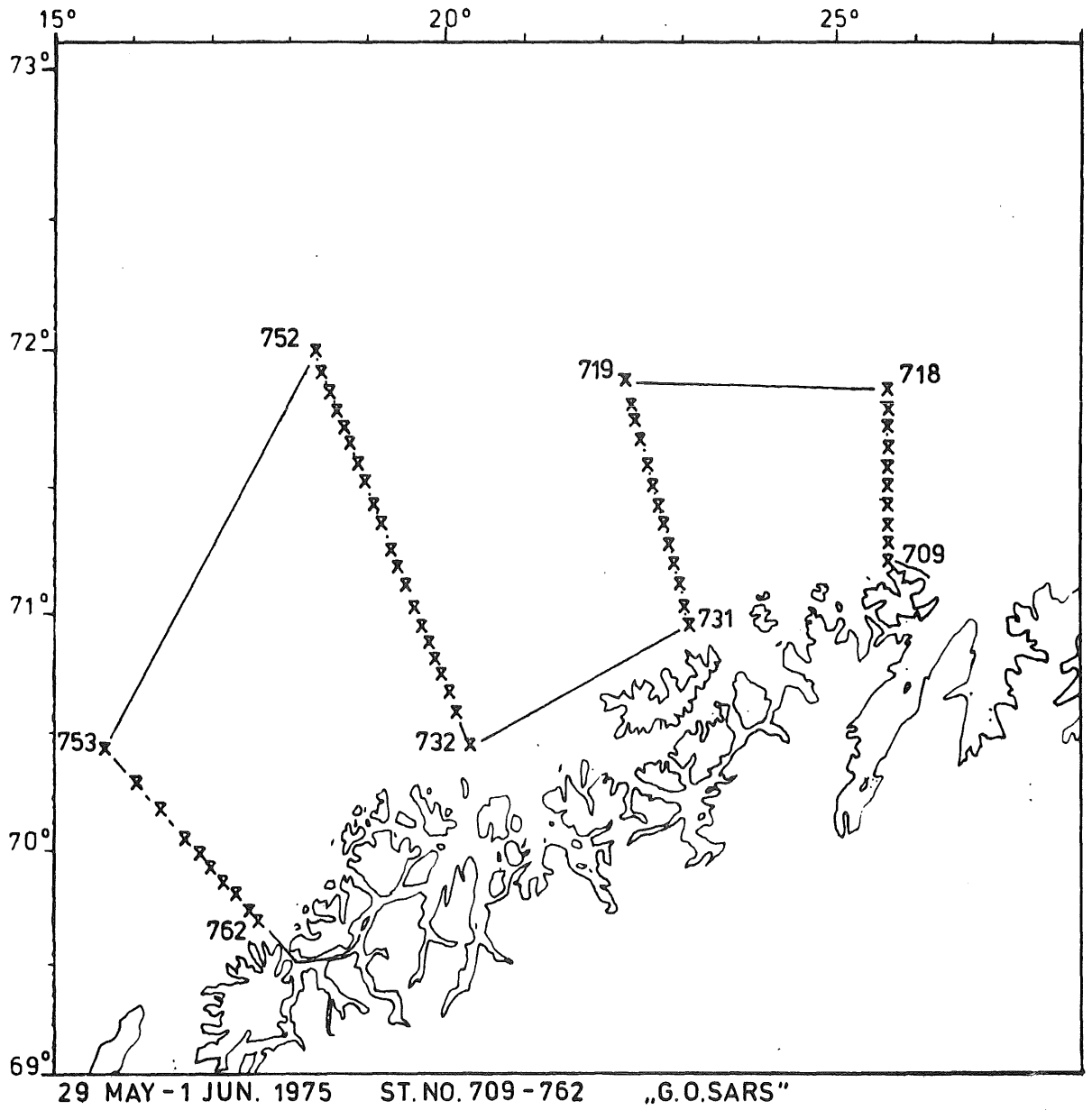

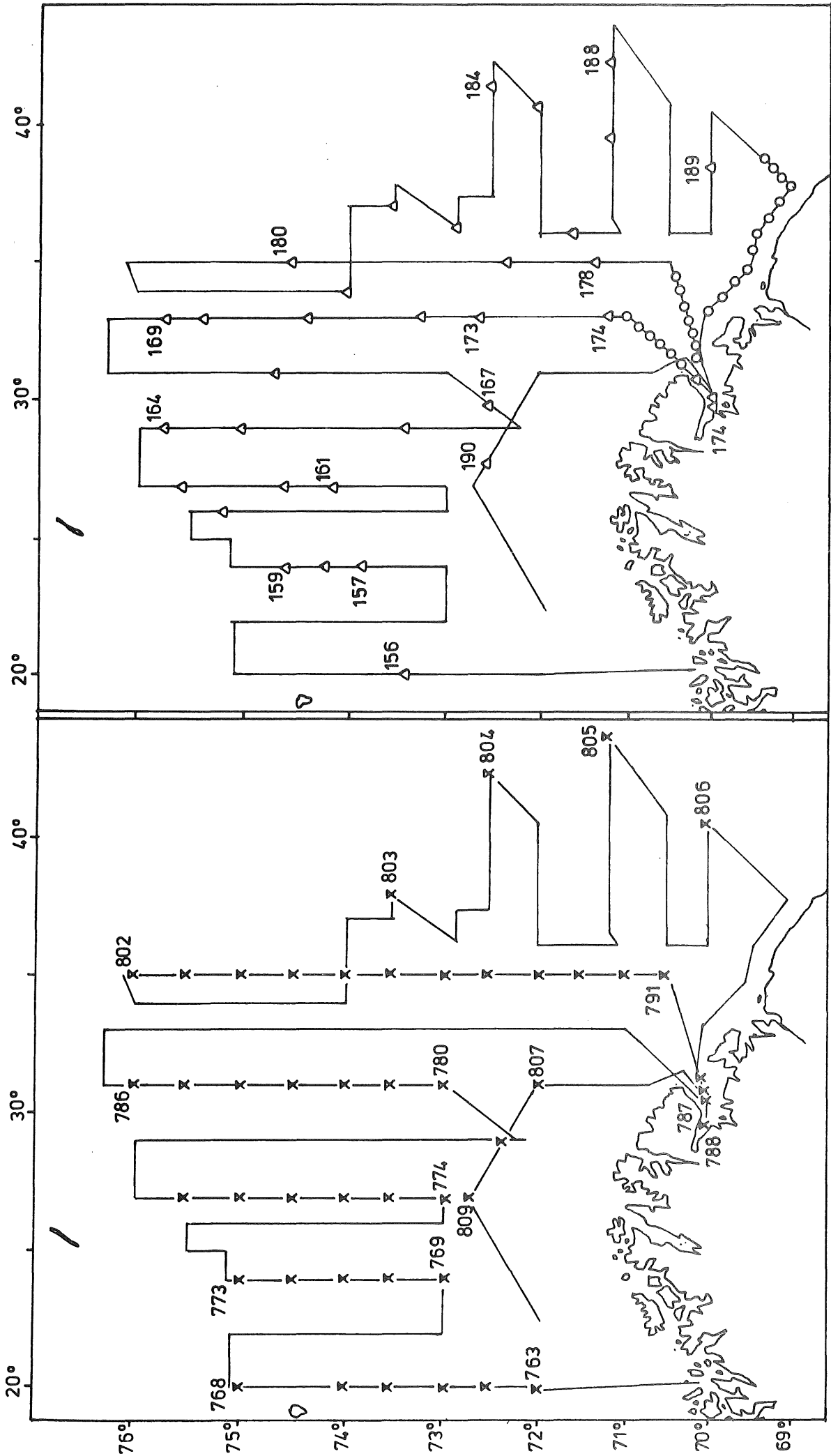

"G.O.SARS"

○ JUDAY PLANKTON NET

○ TRAWL ST. 156-190

ST. NO. 763-809

1-20 JUN. 1975

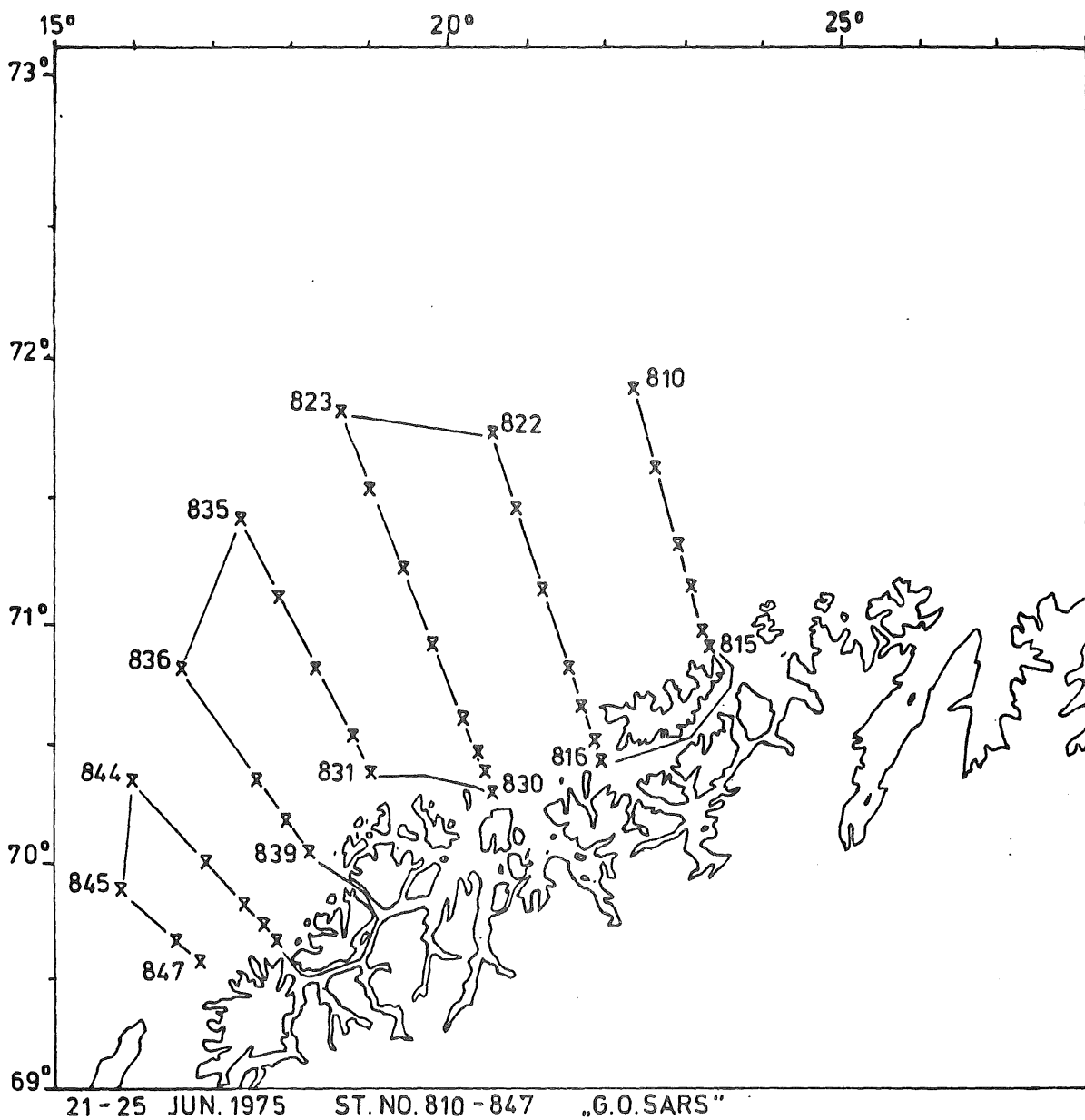

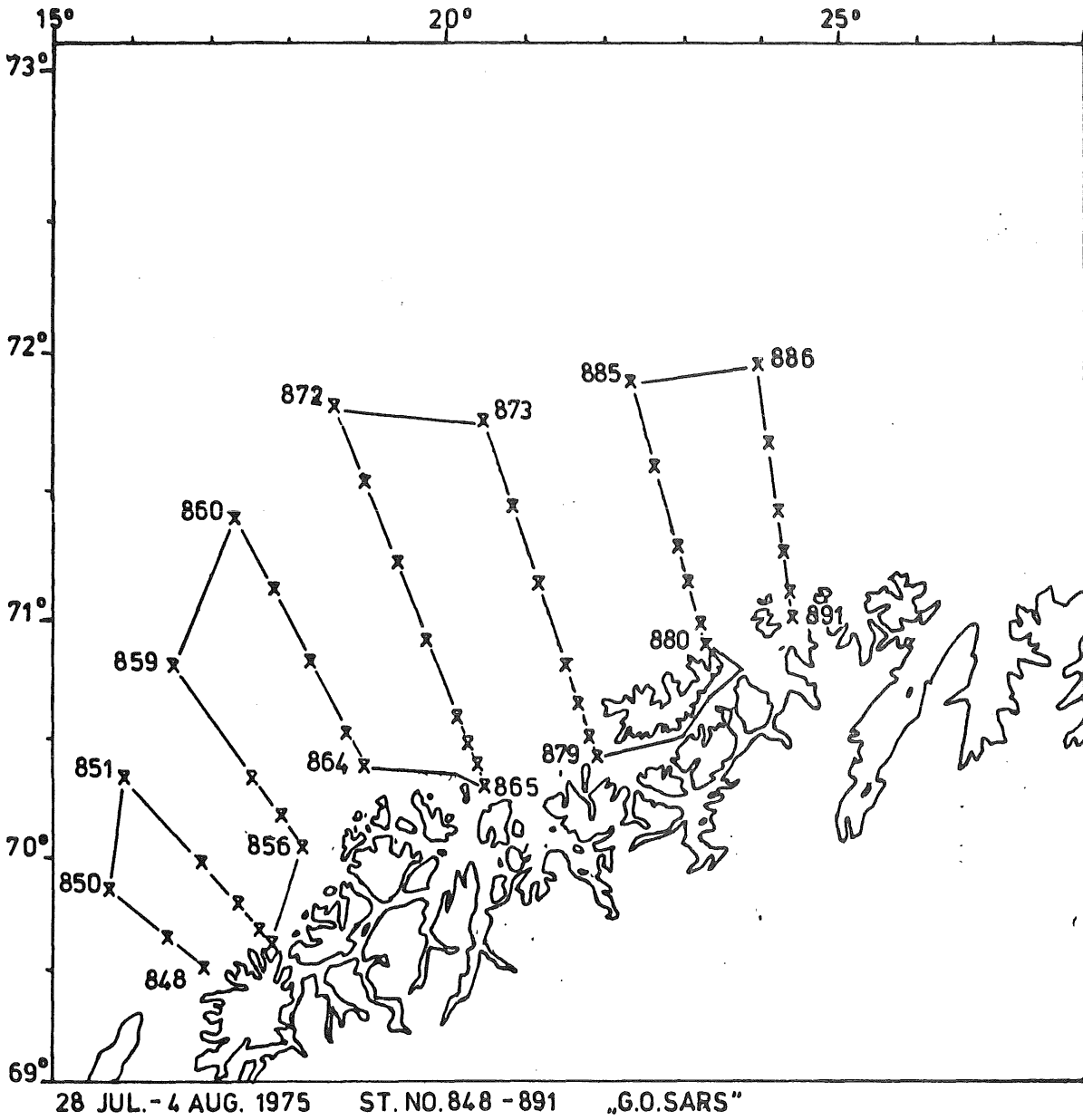

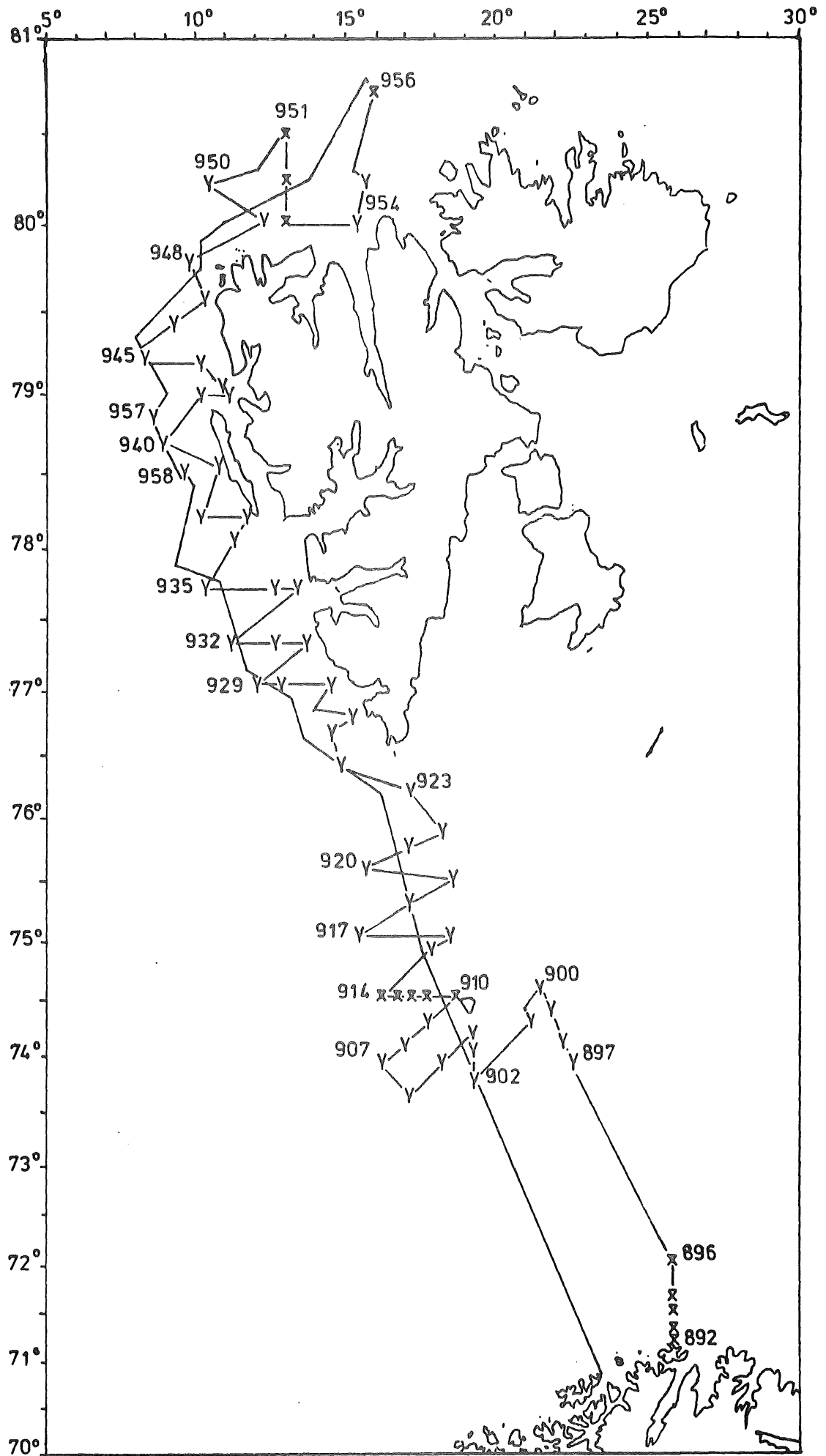

4-14 AUG. 1975 ST. NO. 892-958 "G.O. SARS"

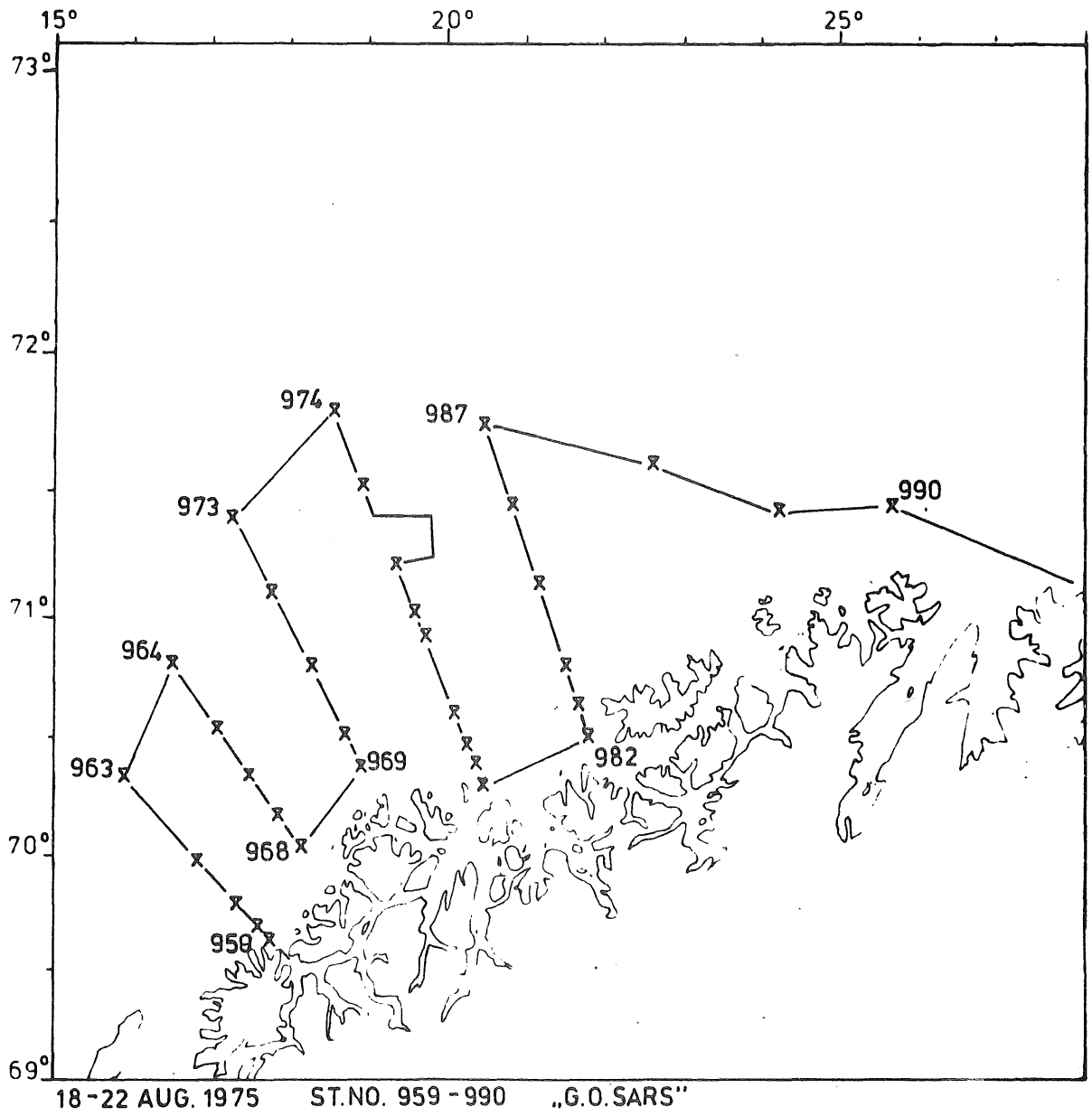

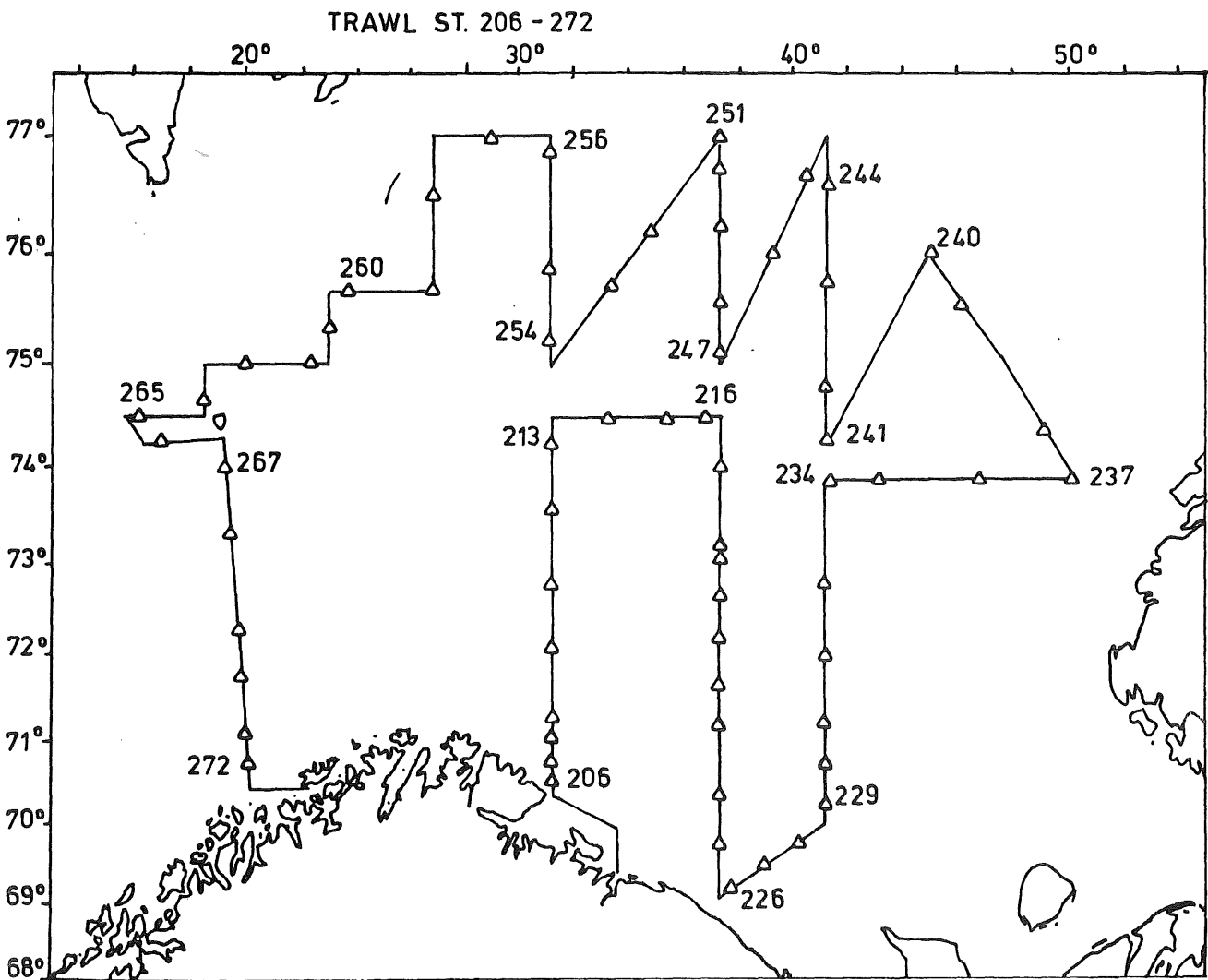
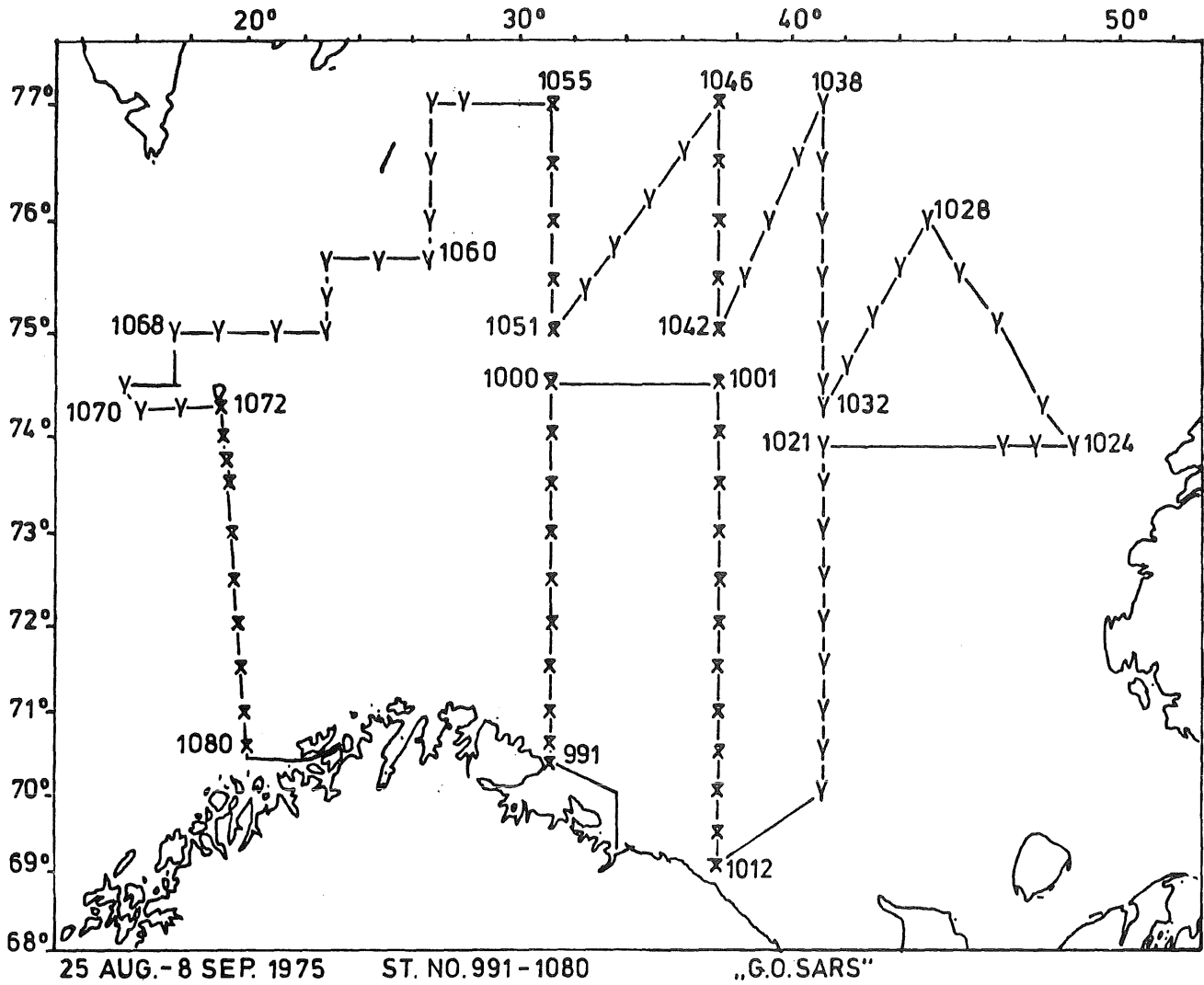

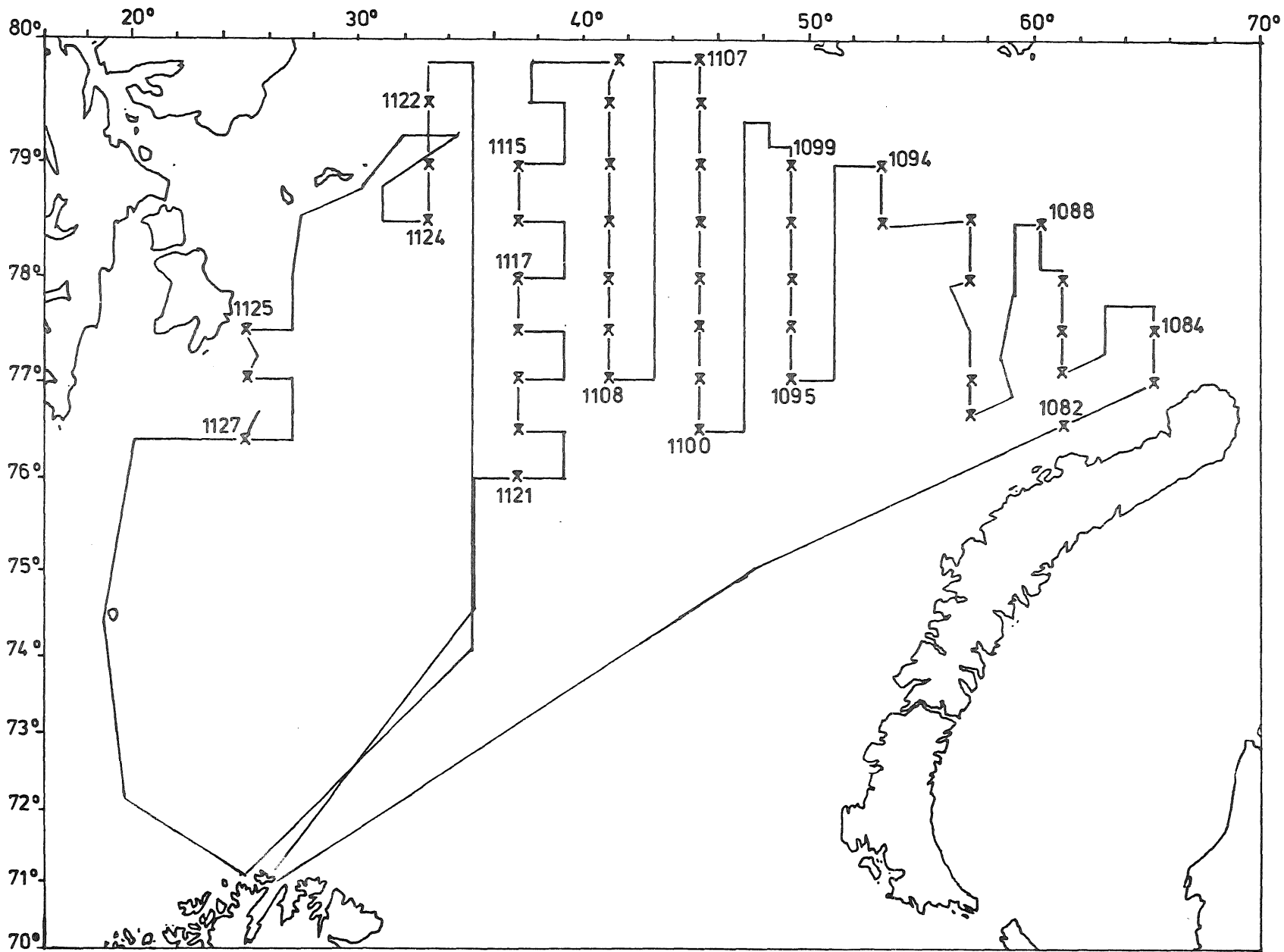

14 SEP - 6 OCT. 1975

ST. NO. 1082 - 1127

„G.O.SARS“

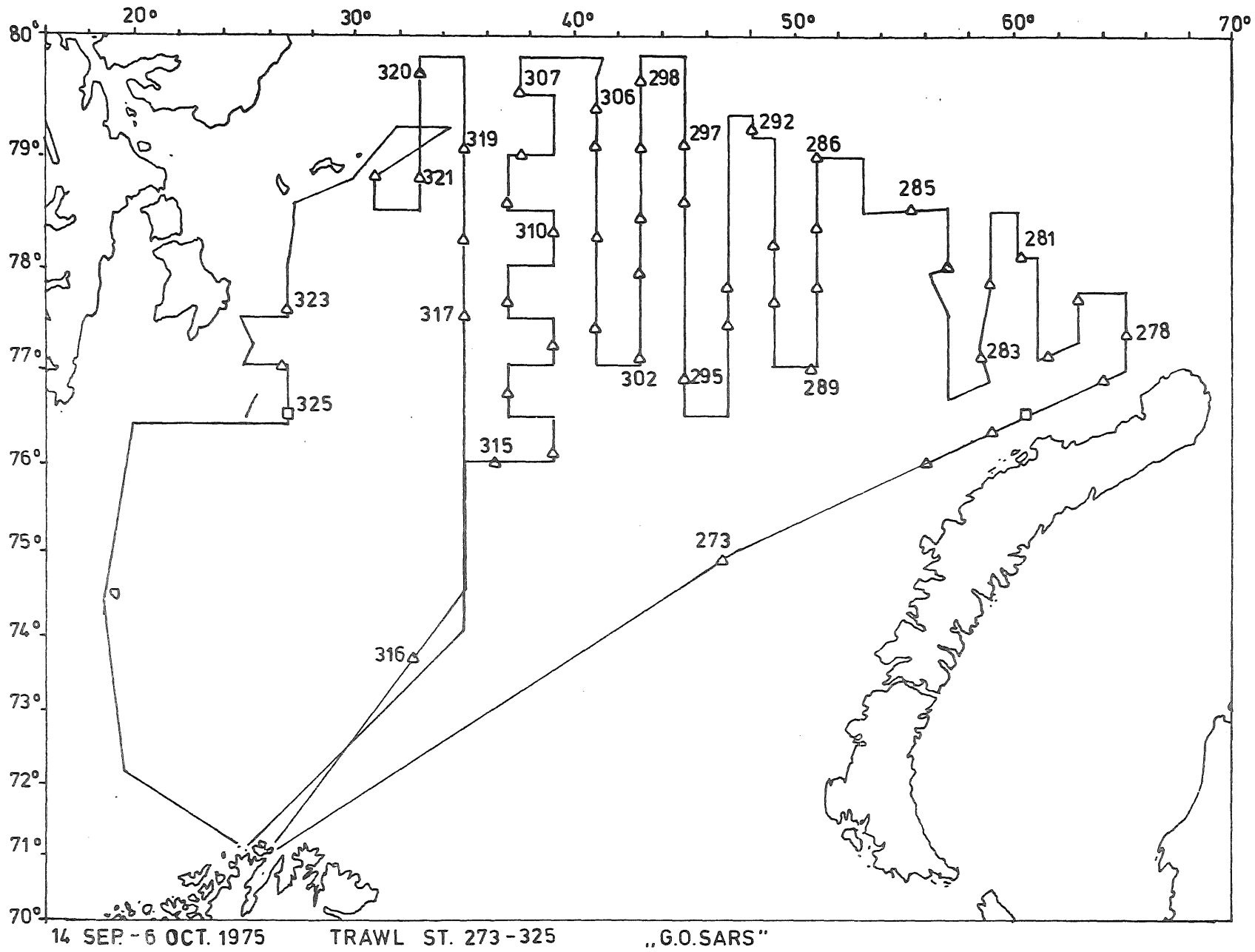

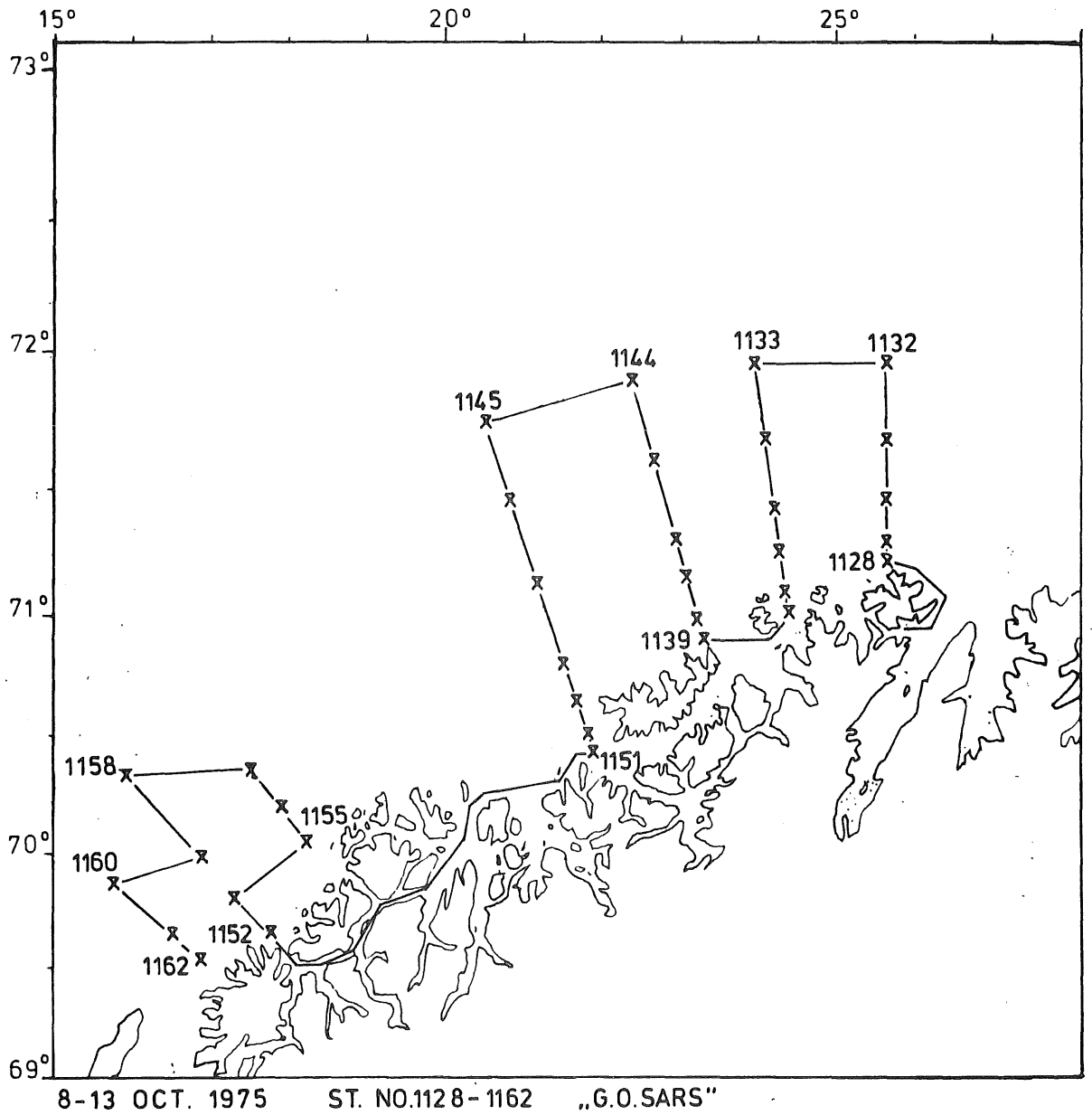

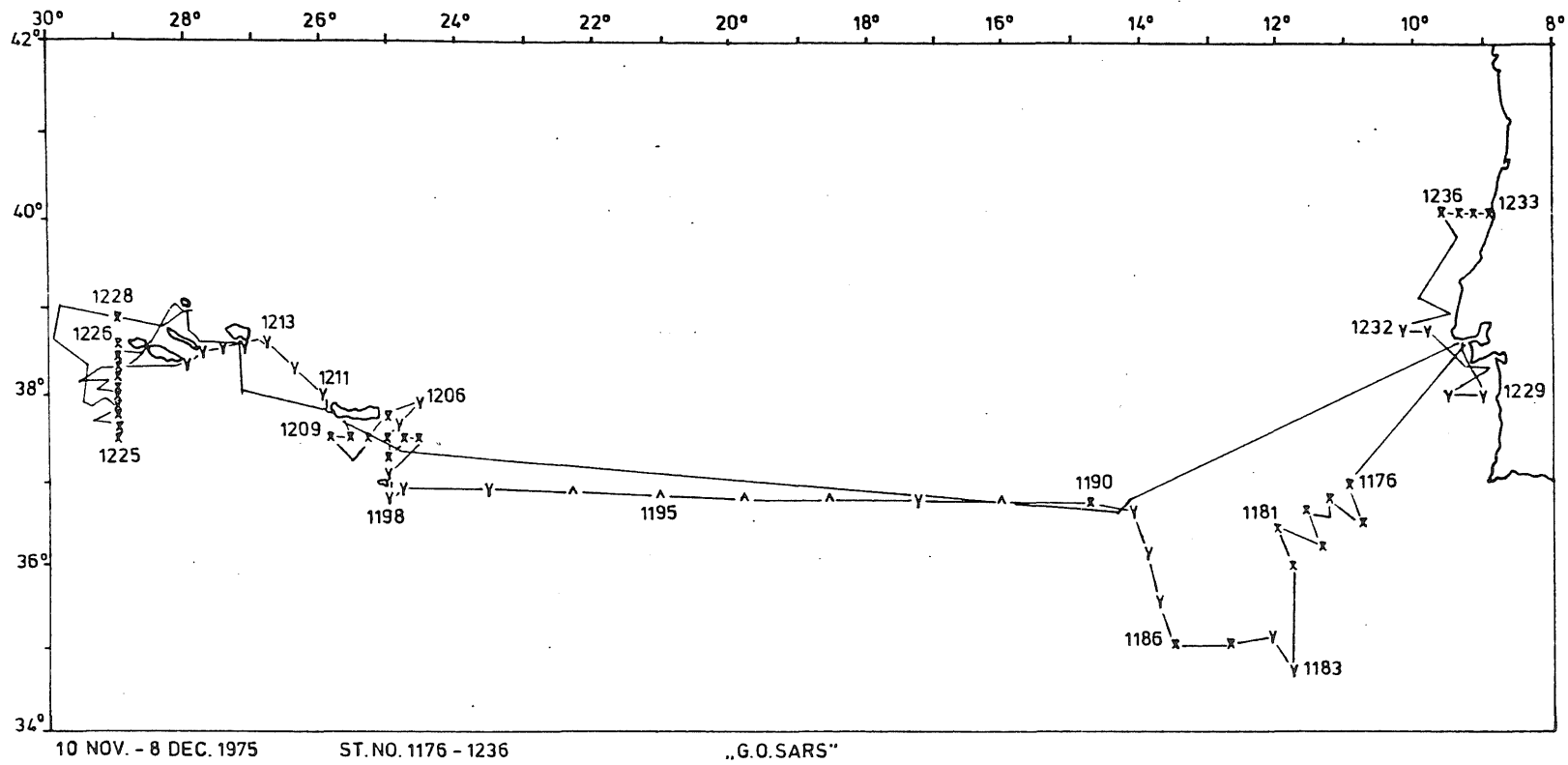

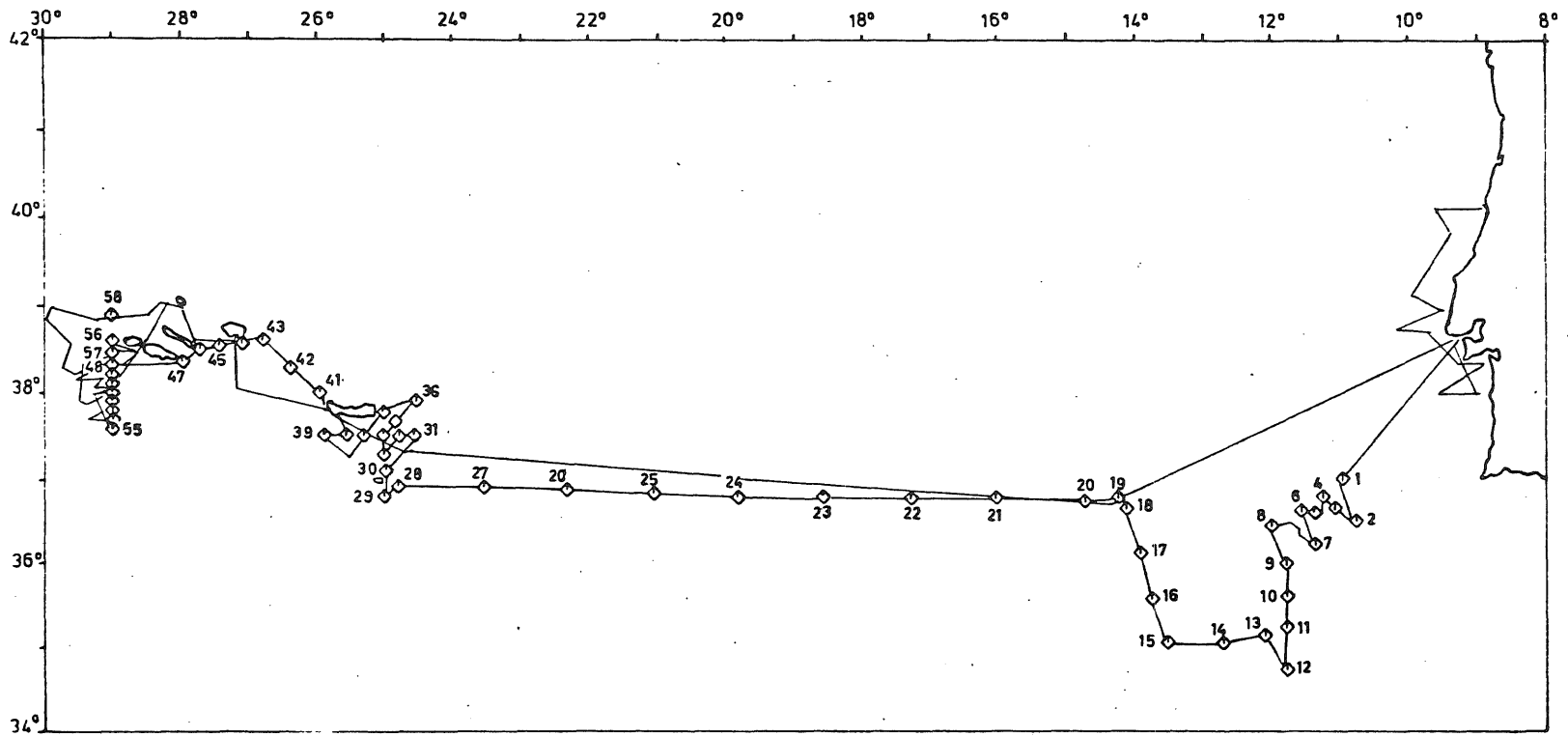

10 NOV. - 8 DEC. 1975 PLANKTONSTATIONS 1-58

„G.O. SARS“

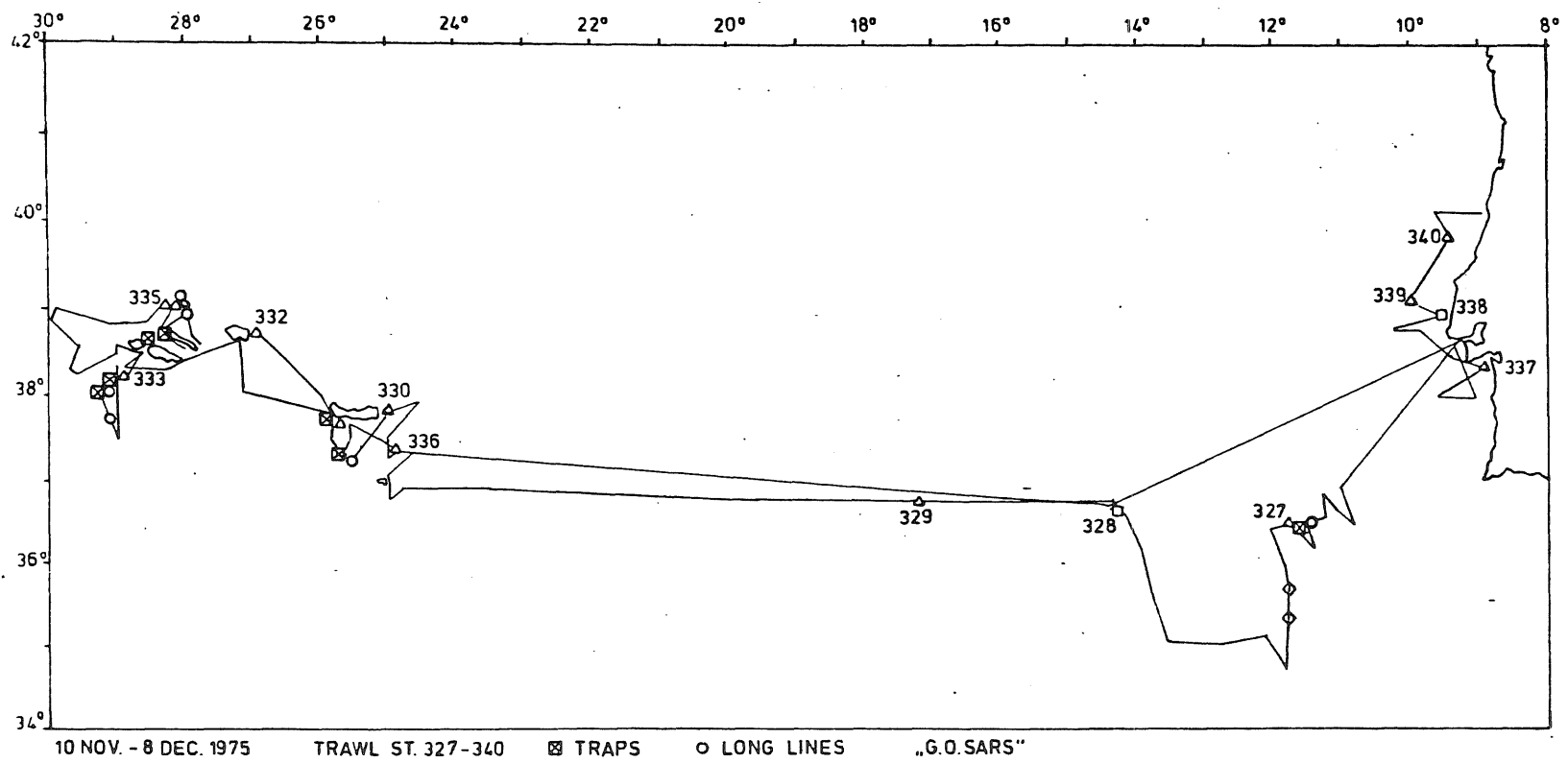

1 57-09 57-58^N/9-10
58.
79
58-59/8-9 89/10
8

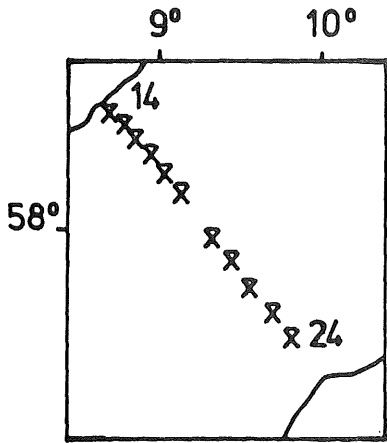

8 FEB. 1975

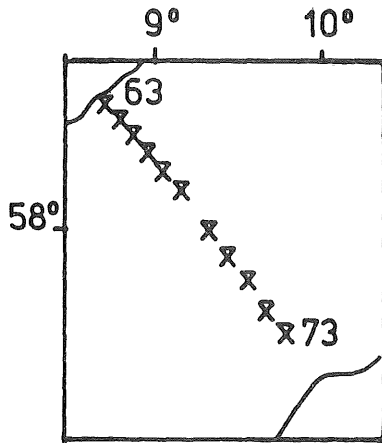

26 FEB. 1975

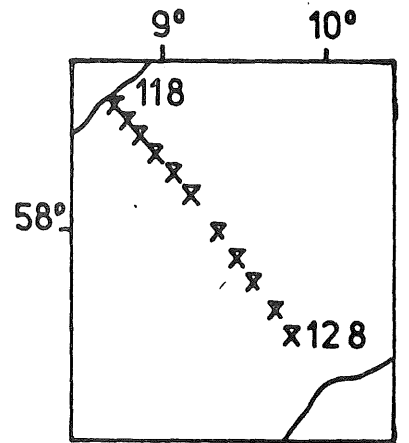

21 APR. 1975

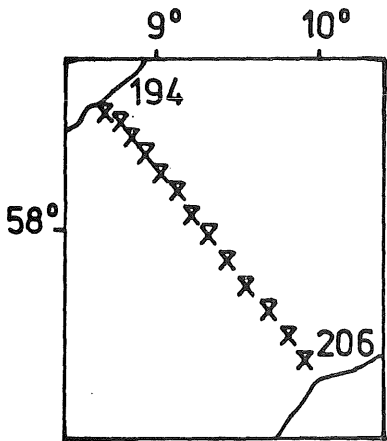

28 MAY 1975

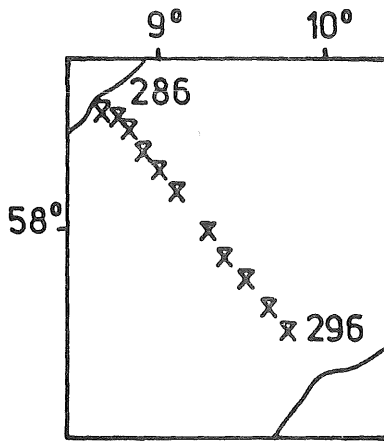

7 AUG. 1975

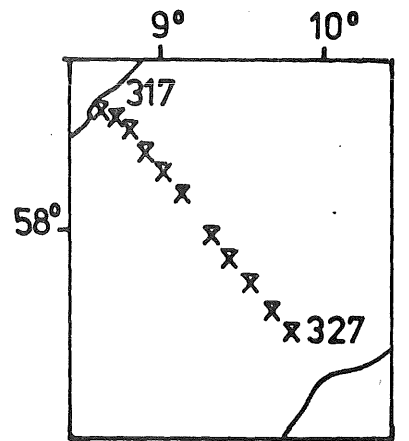

2 SEP 1975

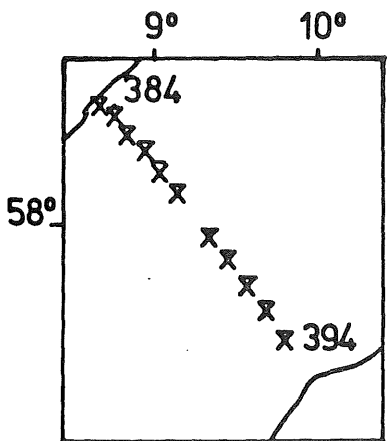

8 OCT. 1975

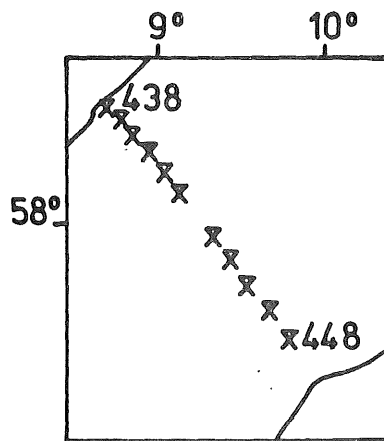

12 NOV. 1975

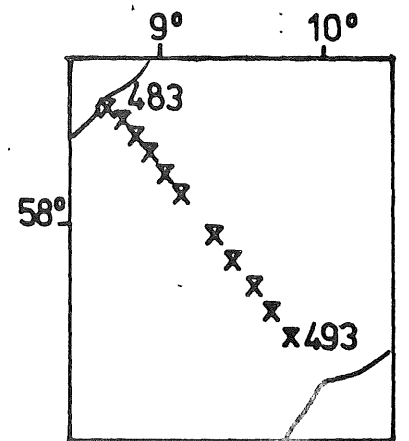

11 DEC. 1975

„G. M. DANNEVIG“

✓

58-59
08-09 41 &
09-10

2
23 x 8
184
34
228

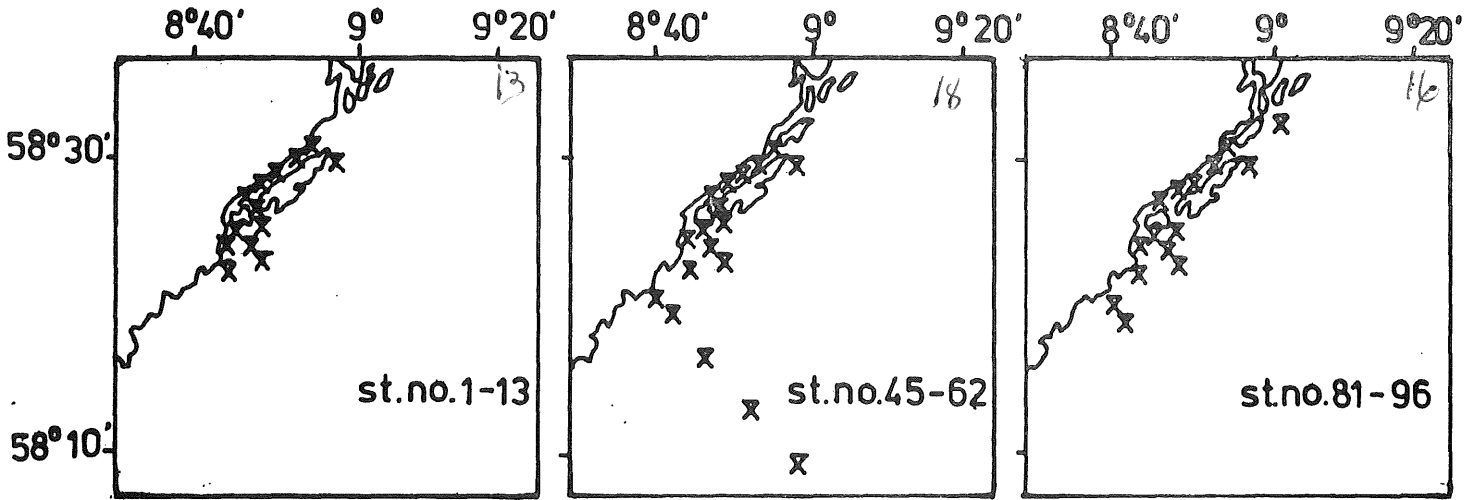

22-23 JAN. 1975

24-25 FEB. 1975

20-21 MAR. 1975

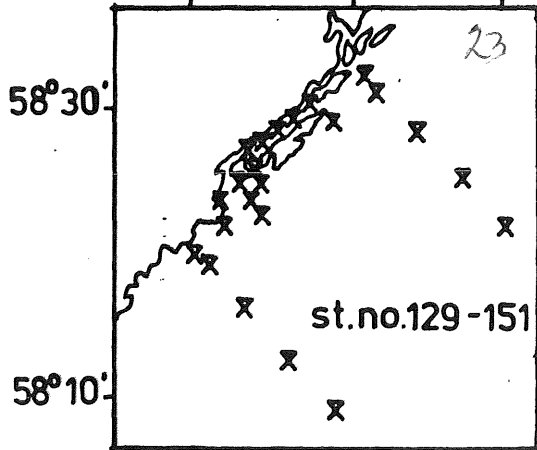

23-25 APR. 1975

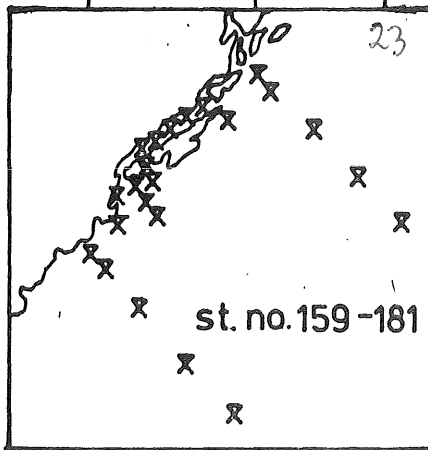

13-15 MAY 1975

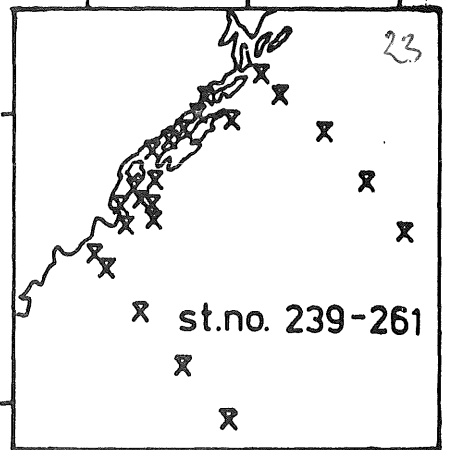

18-20 JUN 1975

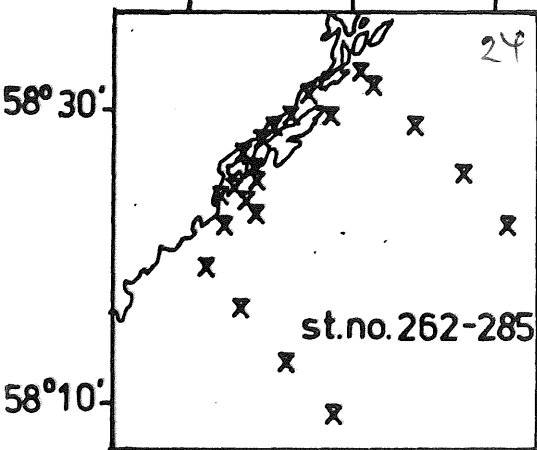

4-8 AUG. 1975

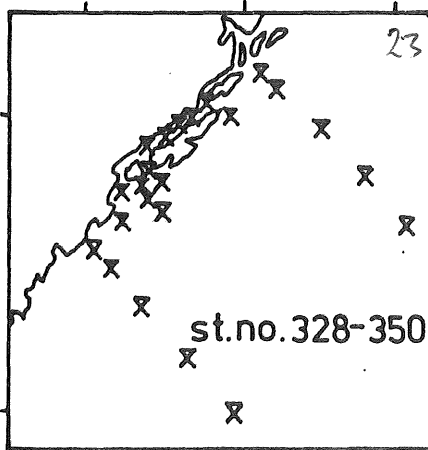

4-8 SEP. 1975

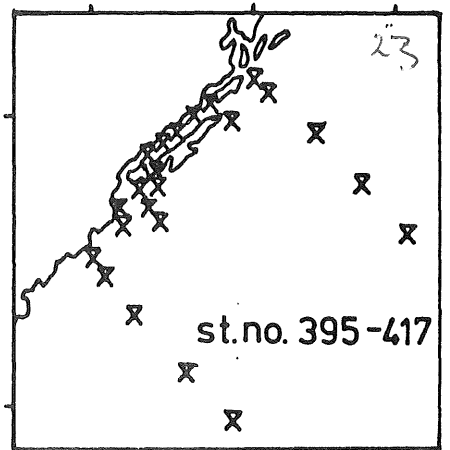

13-18 OCT. 1975

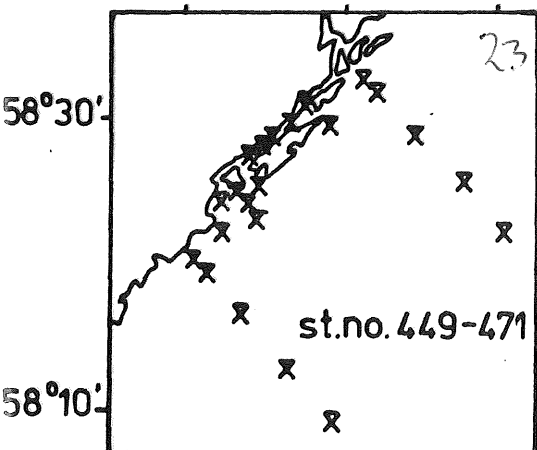

18-20 NOV. 1975

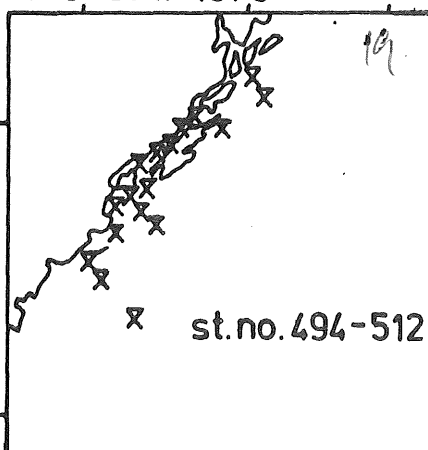

15-16 DEC. 1975

„G.M. DANNEVIG”

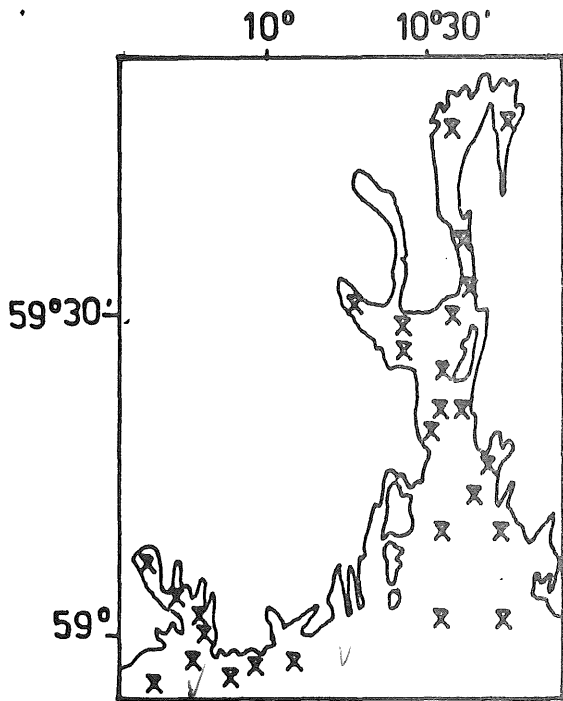

10-20 FEB. 1975

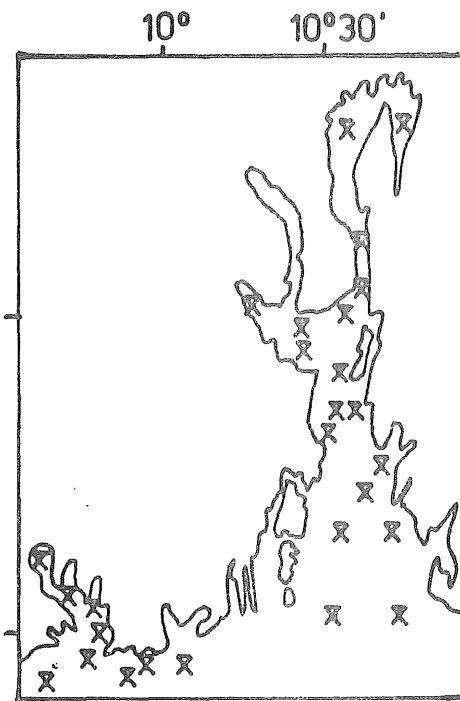

5-12 MAR. 1975

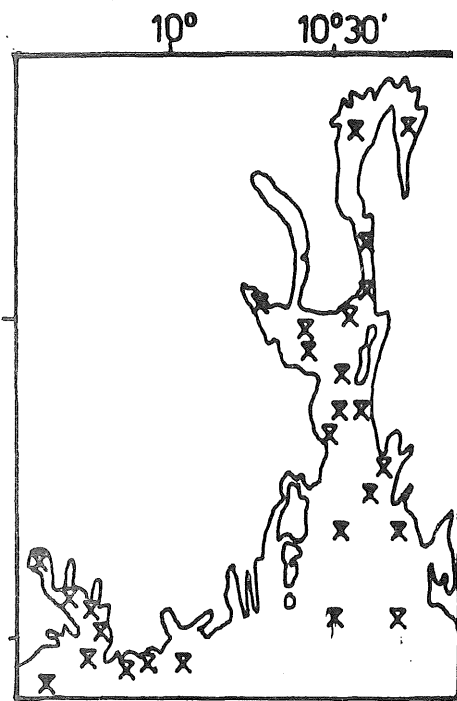

8-17 APR. 1975

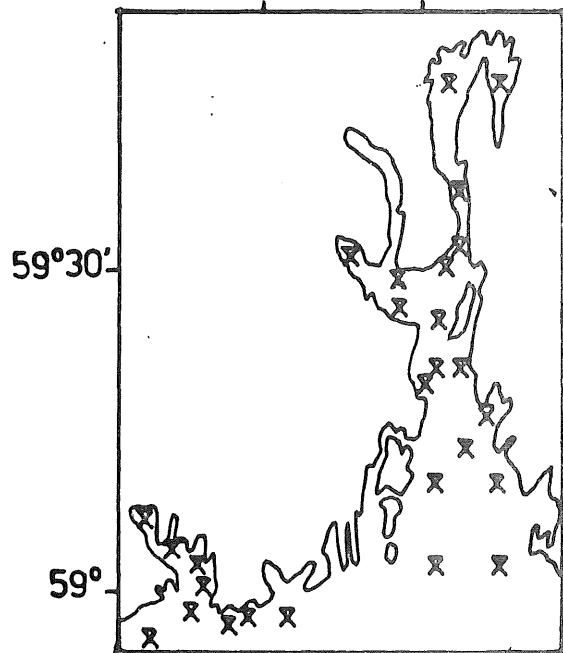

5-12 MAY 1975

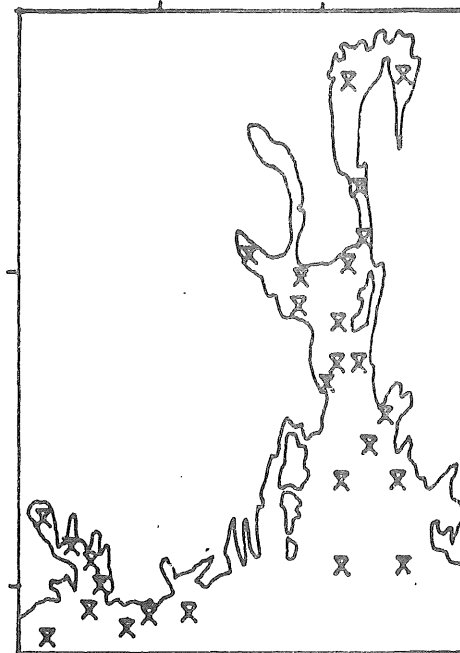

4-12 JUN. 1975

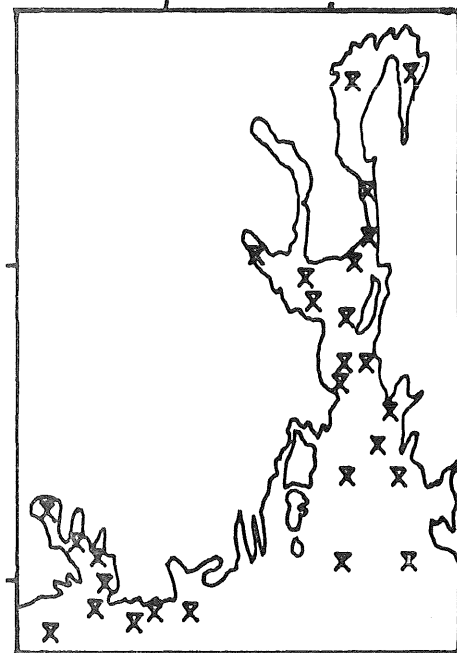

24-28 JUN. 1975

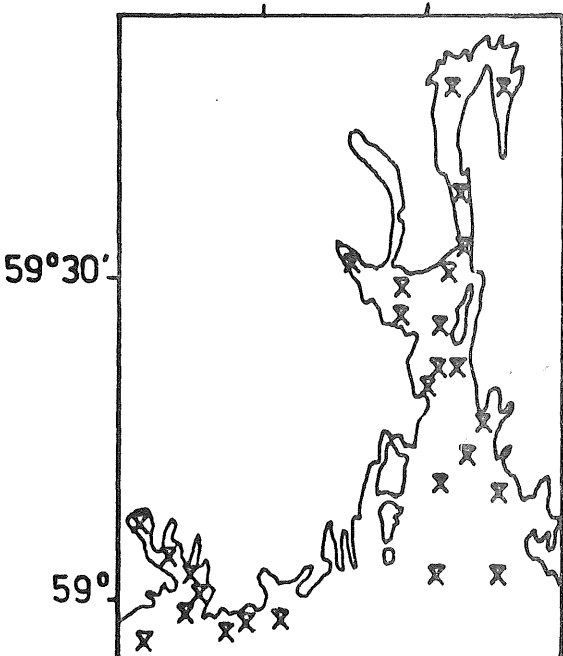

12-27 AUG. 1975

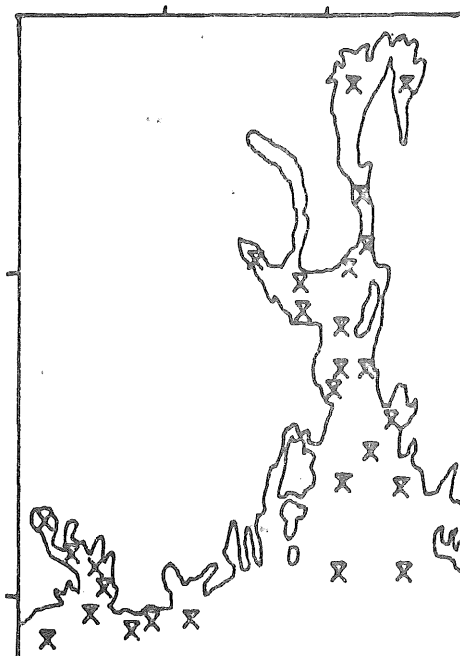

27 OCT.-6 NOV. 1975

5
27/18
216

„G.M. DANNEVIG“

8 2 (23)
total 183

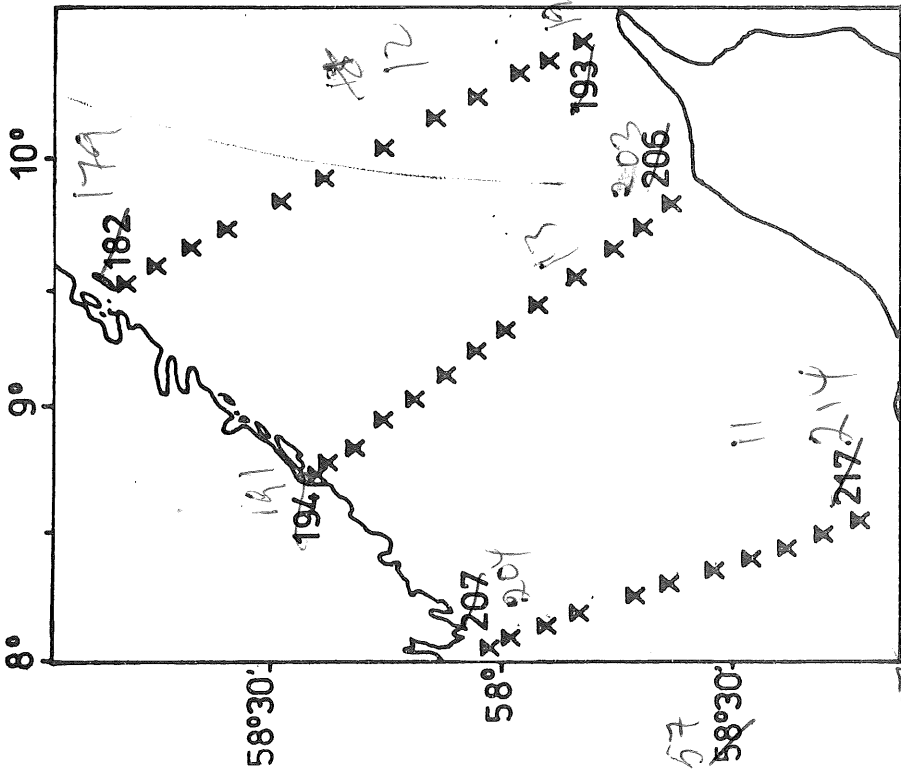

26-30 MAY 1975

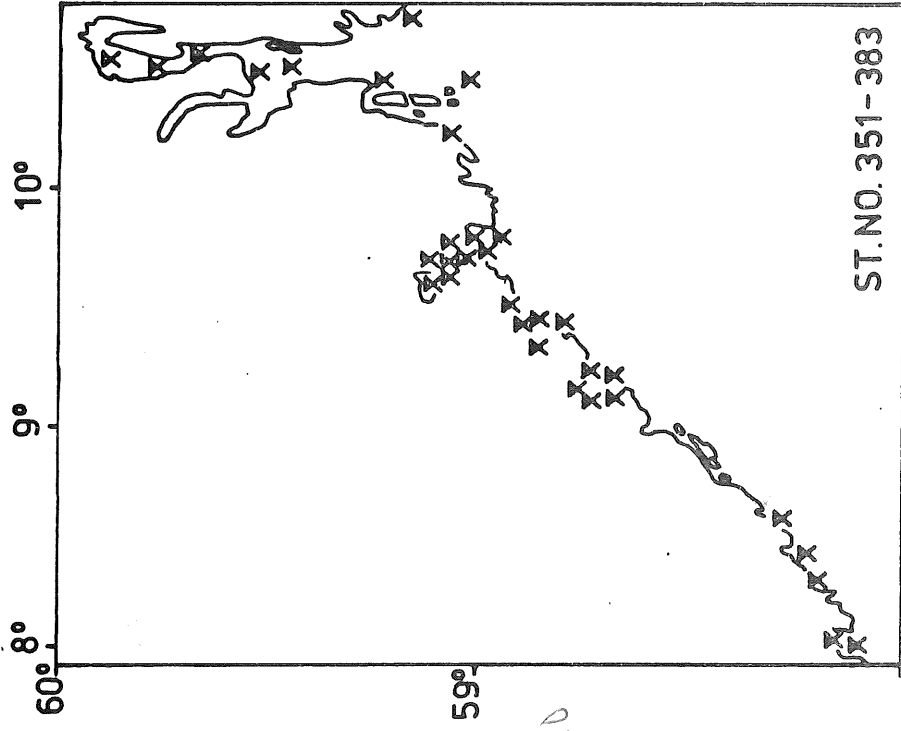

15 SEP - 20 OCT. 1975

„G.M. DANNEVIG“

ST. NO. 351-383

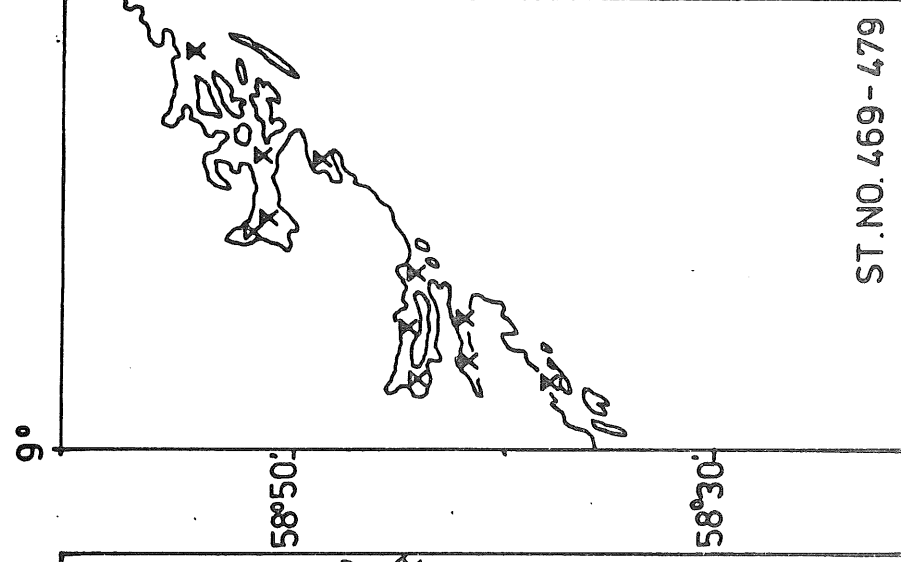

ST. NO. 469-479

24-28 NOV. 1975

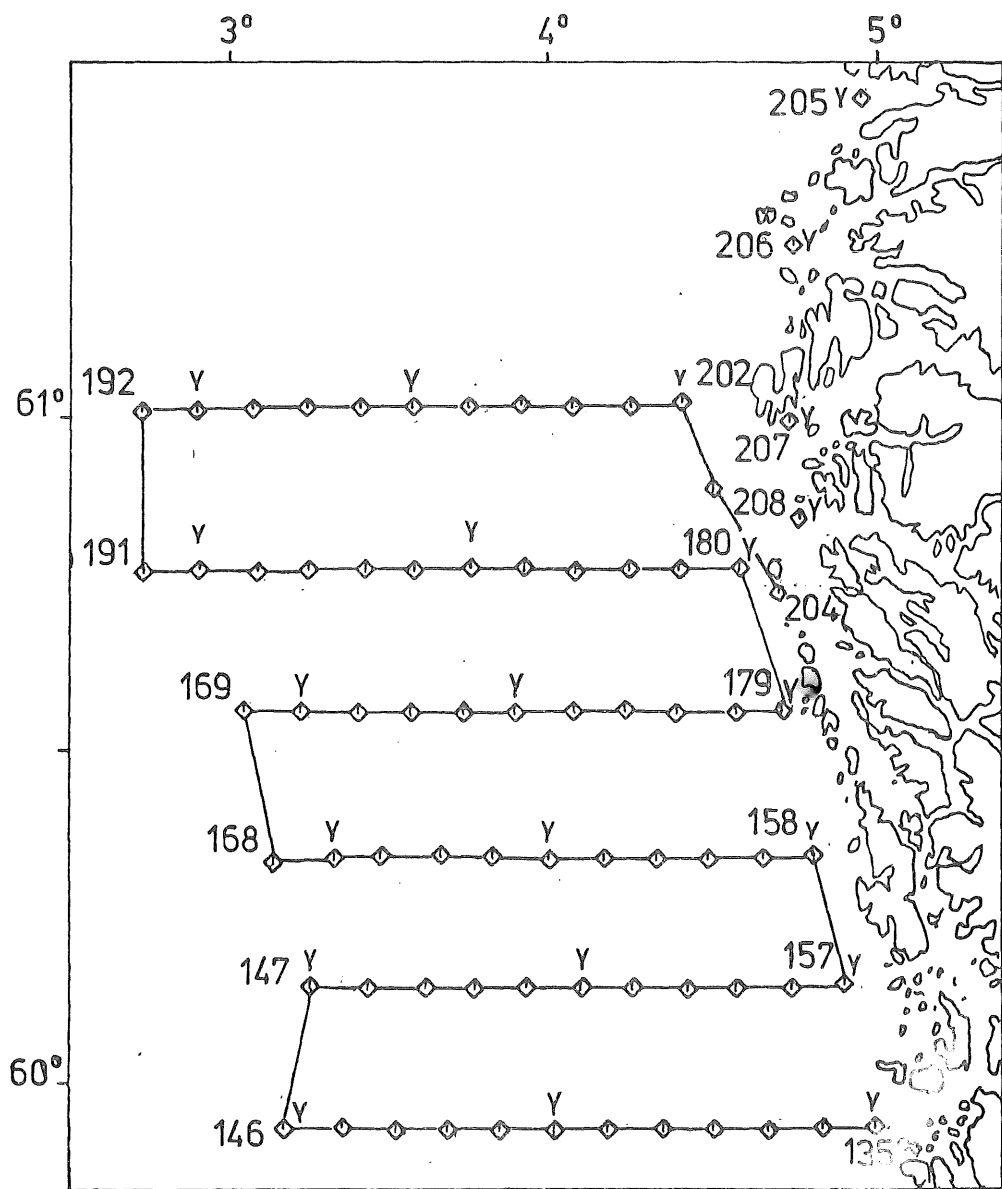

5-14 MAY 1976 PL. ST. 135-208
22 BT. ST.

"PEDER RÖNNESTAD"

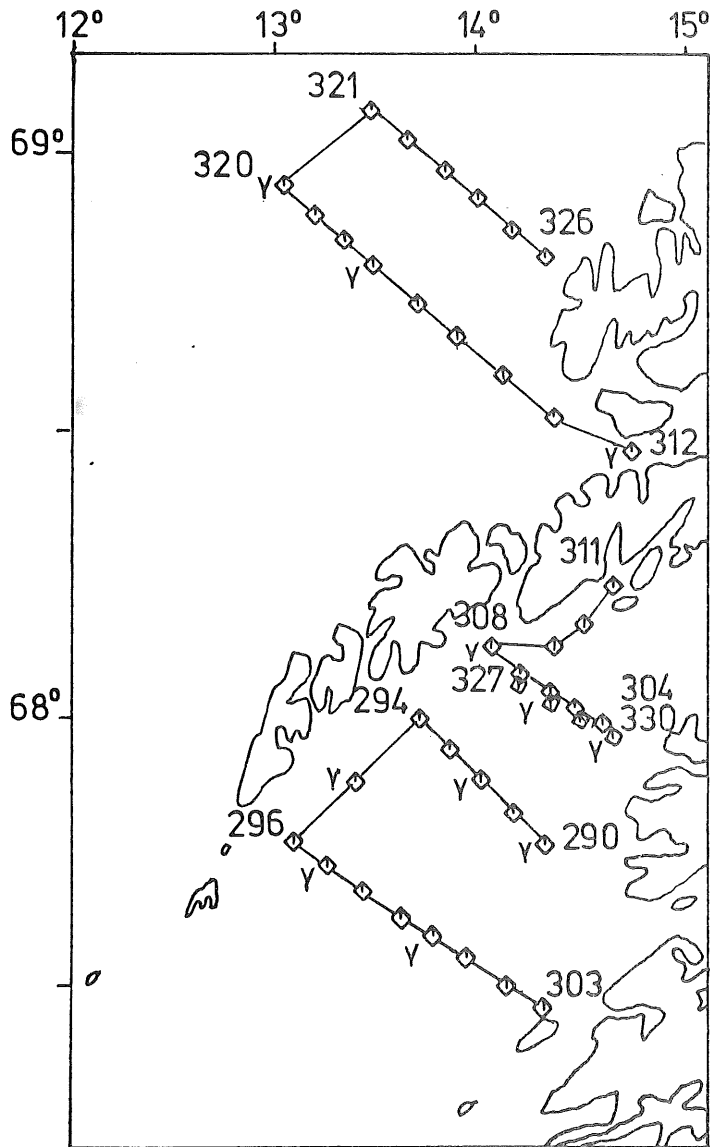
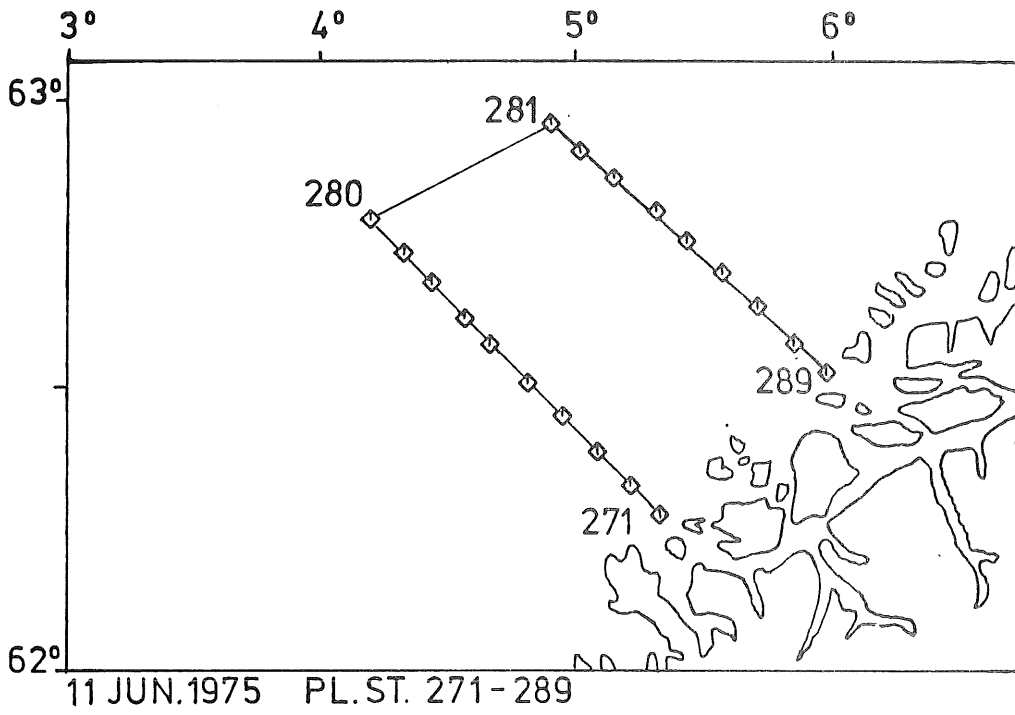

15-19 JUN. 1975 PL. ST. 290-330
11 BT. ST. "PEDER RÖNNESTAD"

