

THE DISTRIBUTION OF COD LARVAE AND PREY ORGANISMS IN THE
LOFOTEN AREA RELATED TO CRITICAL PREY CONCENTRATIONS

by

S. Tilseth
Institute of Marine Research

ABSTRACT

The distribution of cod larvae and their main prey organisms in the first feeding areas off the Lofoten islands have been studied in sheltered and exposed areas in relation to feeding conditions. These findings are discussed in relation to laboratory studies on larval feeding dynamics and food density required to meet metabolic demands. It was found that the cod larvae are sporadic feeders having intervals of digestion between feeding periods.

The maximum gut filling of first feeding cod larvae was close to 3 prey/larval gut when nauplii were the dominant food organism. The larval gut evacuation processes were dependent on the volume and state of digestion of the gut content. The critical prey density for first feeding cod larvae varied between 21 nauplii/l and 190 nauplii/l depending on larval swimming speed and feeding success.

The highest concentrations of both cod larvae and its main prey organism, copepod nauplii, were found in the Austnesfjord, Hølla, Henningsvær and the Vesterålsfjord area. Patches of nauplii in densities between 50-100 per liter were found in

these areas. From larval cod gut content analysis good agreement was found between feeding conditions and food density distribution. The effect of increased wind forces created a homogenous vertical distribution of both cod larvae and prey organisms causing reduced accessibility of food to the cod larvae.

INTRODUCTION

In 1914 Hjort suggested in his hypothesis that the fluctuation in the year class strength of fish varied in magnitude according to the availability of food in the early larval stages. He proposed the "critical period" concept, stating that lack of food at the time of yolk absorption was the predominant factor causing high mortality. Several field studies have been accomplished during recent years to test this hypothesis. May (1974) concludes from a review of 11 investigations that no conclusions could be drawn due to the inadequacy of the sampling gear. Because of the difficulties involved in obtaining adequate data from field investigations a lot of effort have been devoted during the last decade to assess the relationship between prey density and larval fish growth and survival from laboratory experiments (Rosenthal and Hempel, 1970; Lasker et al., 1970; Wyatt, 1972; Hunter and Thomas, 1974; Laurence, 1974, 1977; Lasker and Zweifel, 1978; Houde , 1978, and Werner and Blaxter, 1981). A review of this data (Hunter, 1981) shows that there is a disparity between the required densities of prey for first feeding fish larvae and densities found in the sea. The search model of Vlymen (1977) demonstrates, however, that the average fish larvae could only survive if food organisms were distributed in dense patches. From these findings Hunter (1981) suggests that samples should be taken relevant to larval searching behaviour to obtain a better understanding of the relationship between estimates of food densities required by fish larvae and densities found in the sea. This involves an enormous number of discrete plankton samples both in space and time. This has, however, been accomplished by an in situ particle counter system described by Tilseth and Ellertsen, (1984a) able to count and size particles most frequently

captured by cod larvae. They found small-scale patches with high density of nauplii in the larval cod first feeding areas of Lofoten (Northern Norway). Synoptic observations have been made in the Lofoten area, on the effect of wind forces on the static stability of the upper surface layers and the vertical distribution cod larvae and copepod nauplii (Tilseth and Ellertsen, 1984a and Ellertsen et al., 1984).

The larval cod selection of prey species and sizes have been described in several field investigations (Wiborg, 1948; Marak, 1960; Last, 1978 and Ellertsen et al., 1977). The larval feeding rate, gut evacuation rate and digestion time of the main larval cod prey organisms have been studied in laboratory experiments (Tilseth and Ellertsen, 1984b) and these findings have been applied to define criteria for larval gut content analysis. Laboratory experiments have been performed to estimate critical prey densities for first feeding cod larvae (Solberg and Tilseth, 1984). The objectives of the present paper are to review some of these laboratory findings and compare these findings with the results from a series of field investigations reported by Ellertsen et al. (1984) on the distribution of cod larvae and nauplii in the Lofoten area. The materials and methods applied by these authors as well as their results will also be described.

MATERIAL AND METHODS

LABORATORY STUDIES

Feeding.

Cod eggs were artificially fertilized and incubated according to the method described by Tilseth and Ellertsen (1984b).

A homogenous age group of larvae were made during hatching by removing all larvae hatched during the first 24 hours and all unhatched eggs 48 hours later. The cod larvae start exogenous feeding at day 5 post-hatching, and according to Ellertsen et al. (1980) the most active feeding occurs at day 7. In the

present investigations all feeding experiments were performed with cod larvae at age 7 days post-hatching. The larvae were fed natural plankton sampled by an automatic pump system described by Tilseth *et al.* (1984). Due to the filters of the system the size range of the prey varied within 90 μ m - 500 μ m.

The experiments were performed under constant temperature (5°C), salinity (34.5‰), light (100 lux) and prey density conditions (0.5 prey/ml) in 5 l black-walled aquaria. Just prior to the experiments these aquaria were stocked with prey organisms. Cod larvae were sampled every 15 minutes for 1 hour followed by 1 hour intervals. The experiments were terminated after 5 hours. The cod larvae were preserved in 4% formaline in 10‰ sea water for gut content analysis.

The larval cod digestion time of prey organisms was studied *in vitro*. Cod larvae, visually observed when capturing prey, were transferred to a small aquarium (Fig. 1) where the gut content of the transparent larvae could be observed by a binocular microscope. The prey was dissected out of the larval gut when it became transparent and stained with 1% toluidine blue in 1% borax.

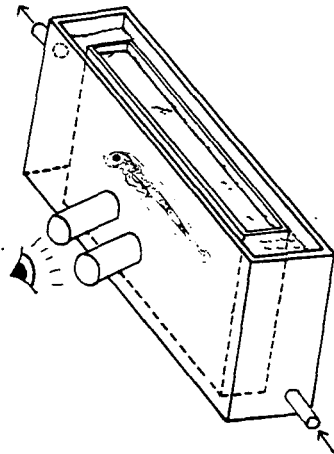

Fig. 1. Cod larvae *in vitro* observation aquarium (10 cm x 10 cm x 2 cm). The aquarium was submerged in a glass thermostatically controlled waterbath (5°C) during observation.

The larval cod gut passage time was studied by feeding the larvae for 1 hour (0.5 prey/ml) and transfer these larvae to filtered sea water. Twenty larvae were sampled for gut content analysis every 30 minutes for 2 hours and thereafter every 1 hour for 2 hours.

Five hundred cod larvae were fed for 24 hours (0.1 prey/ml) in a 70 l black walled aquarium. Twenty larva were sampled every hour through the 24 hour cycle. The light intensity was kept at 100-200 lux during daytime and reduced to 0.5 lux from 1900 h to 2400 h and increased again to 100 lux at 0500 h.

Feeding Success, Perceptive Field.

The larval cod rate of success in capturing prey organisms and the larval perceptive field were measured during the first four days of exogenous feeding (day 5 to day 8 post-hatching). Temperature (5°C) salinity (34⁰/oo) light intensity (100 lux) and prey density (0.5/ml) were kept constant during the observations. These were made visually in a 10 l black-walled, white-bottomed aquarium. Five larvae were transferred from the incubator, and the first larva showing food searching behaviour was observed for 15 minutes, while the remaining four were disregarded. The number of attacks were recorded concomitantly with the estimation of reactive distance, (e.g. distance from the larval eye to prey, when the larvae shows that it has perceived the prey by changing swimming pattern (see Ellertsen et al., 1980), relative to the larval standard length. The larva was preserved in 4% formaline in 10⁰/oo sea water for gut content analysis. Ten larvae were observed each day.

Swimming Speed.

The swimming speed of cod larvae was measured daily from day 2 to day 13 post-hatching. Larvae from two different female fish were measured. The swimming speed of 20 larvae was measured each day in a light-proof box where the artificial light intensity were adjusted to 100 lux by neutral filter. The light

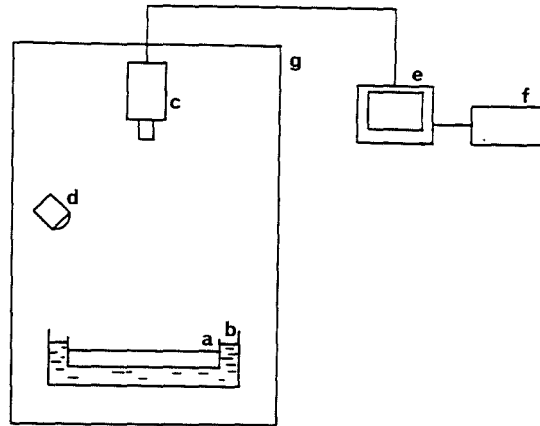

Fig.2. Outline of the observation system for recording of cod larval swimming speed a=swimming aquarium, b= thermostat controlled water bath, c= TV camera, d= light source, e= monitor, f= video recorder g= light proof box.

source was placed at a 45° angle to the observation aquarium. This aquarium was 30 cm in diameter and 5 cm deep placed in a thermostatically controlled water bath at 5°C (Fig. 2). The position of the larva relative to the surface or bottom could be estimated by measuring the distance between the larva and its shadow. The larvae were given an adaption period of 30 minutes prior to recording. The larval swimming speed was recorded for 15 minutes on videotape by a TV camera. The swimming speed of each larvae was calculated by measuring the swimming distance directly on the TV-monitor by playback of the video-tape. Swimming speed was not measured when the larvae were at the surface or the bottom of the aquarium.

FIELD STUDIES

The distribution of cod larvae in the Lofoten area was studied by Juday net (80 cm, $375\mu\text{m}$ mesh) and modified plankton nets (160 cm, $375\mu\text{m}$, Ellertsen et al., 1984) and sampled by vertical hauls from 50-0 m. The investigations were carried out during the first 3 weeks in May from 1979 to 1983. A map of the Lofoten area is presented in Fig. 3. To investigate the

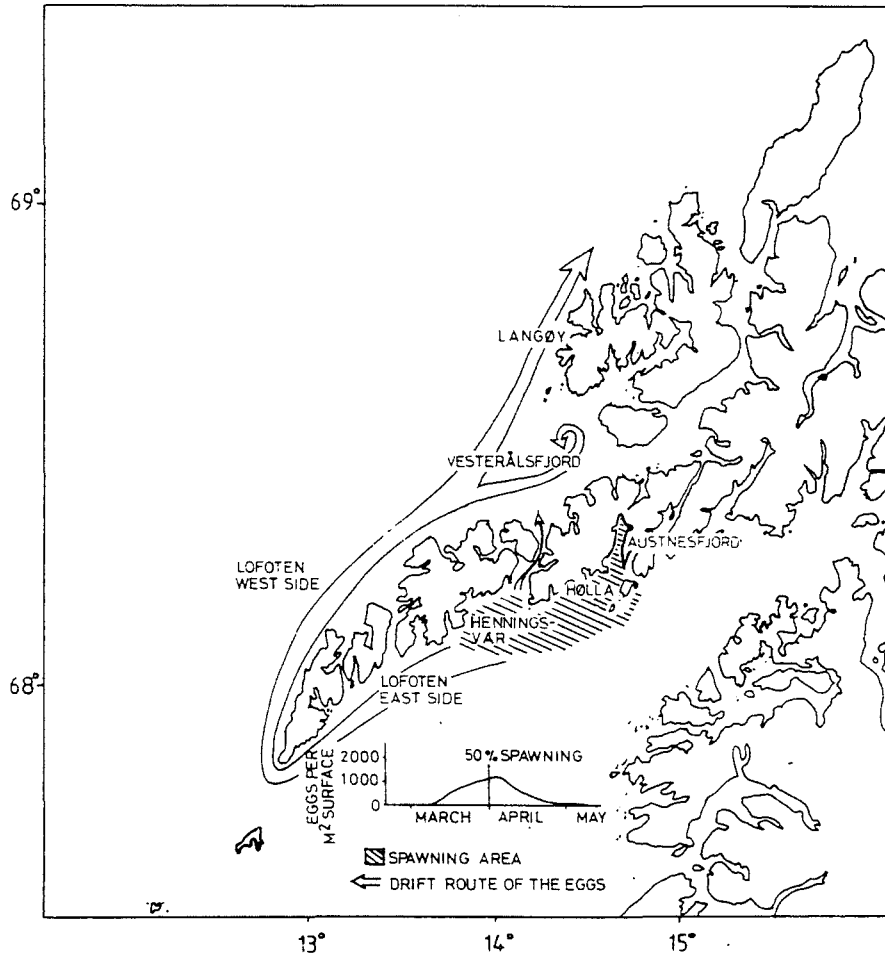

Fig. 3. Map of the Lofoten area with the main cod spawning area, spawning period and main drift route of eggs (from Ellertsen et al., 1984).

vertical distribution of cod larvae, samples were taken at 5, 10, 15, 20, 25, 30 and 35 m depths by submersible electric pumps as described by Solemdal and Ellertsen, (1984). Fifteen m^3 of sea water was sampled at each depth. The diel vertical distribution of cod larvae was investigated both in the sheltered Austnesfjord (in 1980) and the open ocean bay of the Vesterålsfjord (in 1982). Cod larvae were preserved in 4% formaline in 10⁰/oo sea water solutions for morphometric measurements, dry weights and gut content analysis.

The distribution of larval cod prey organisms in the Lofoten area was investigated by a small submersible electric pump (Flygt 2051, 250 l/min). Samples were pumped on deck through a

50 m long by 5 cm in diameter hose. Samples were taken at 0, 2.5, 5, 7.5, 10, 12.5, 15, 20, 25, 30 and 40 m depths. The sea water was collected in calibrated tanks (23.7 l) and zooplankton was filtered through 90 μm mesh plankton nets. The whole zooplankton sample was counterered and identified by microscope. The small-scale distribution of zooplankton patches was studied by an in situ particle counter system described by Tilseth and Ellertsen (1984a). Zooplankton samples were taken on every second station on each section and during 24-hour stations (the Austnesfjord and the Vesterålsfjord) every second hour.

Temperature and salinity were measured by a CTD sonde. The static stability of the water masses during diurnal stations is expressed in the squared Brunt-Väisälä frequency (Phillips, 1977) computed for 5 m intervals.

LABORATORY STUDIES

Feeding.

Ninety-seven percent of the prey organisms identified in the gut content analysis were copepod nauplii, 1.6% could not be identified and 1.4% were bivalve veliger larvae, rotifers and copepod eggs.

The results of the gut content analysis are given as larval cod feeding incidence and feeding ratio (Fig. 4). The larval cod feeding incidence is defined as the percentage of cod larvae with gut content in the sample. Fig. 4(A) shows the increase in feeding incidence during the 5 hour feeding experiment, showing a rapid increase from 0% to 90% during the first 2 hours of feeding, varying between 80% and 93% during the next 3 hours. About 7%-10% of this larval population did not feed.

The cod larval feeding ratio is defined as the ratio between the number of prey found in the gut content to the number of larvae examined in the sample. Fig. 4(B) shows the larval feeding ratio against time during the feeding experiment. The

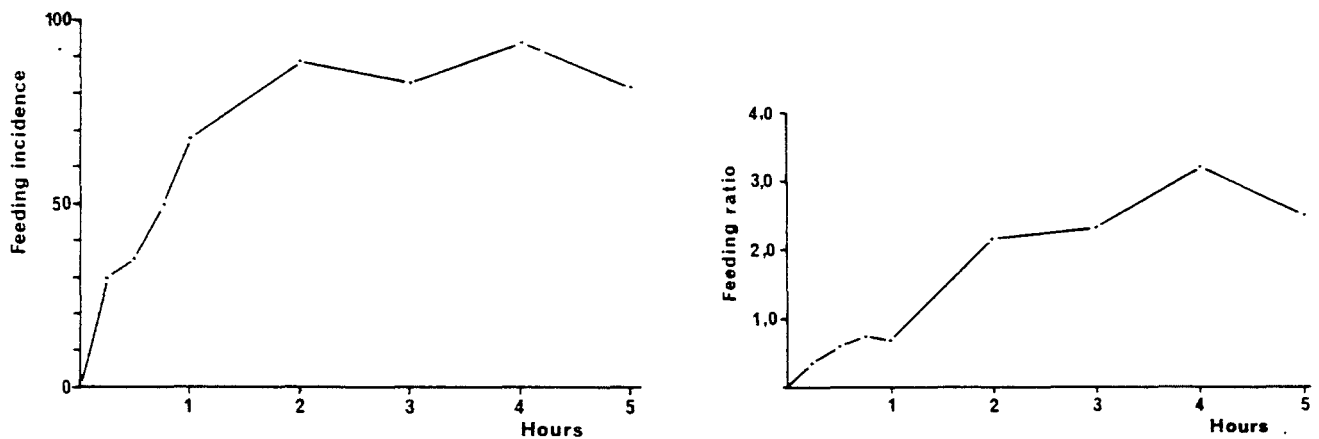

Fig. 4. Cod larval feeding incidence (% larvae with gut content) and feeding ratio (no of prey/larval gut) during a 5 hour feeding experiment (from Tilseth and Ellertsen, 1984b).

feeding ratio increased during the first few hours, reaching a maximum level of 3.2 nauplii/larval gut after 4 hours. This seems to be the maximum gut filling, when the volume of the nauplii is still unchanged by digestion. The volume of the average nauplius captured by first feeding cod larvae was estimated to 91 μ l. The mean volume of a distended gut of a 4.5 mm standard length cod larva was estimated to 329 μ l. This gives a maximum filling of 3.5 nauplii/larval gut. The larval feeding rates are estimated for the time period of increasing feeding ratio. A linear regression analysis of these data gave feeding a rate of 0.94 nauplii/larvae gut per hour ($y=0.18 + 0.76x$, $r^2=0.96$).

The larval cod digestion time for prey is defined as the time for the gut content to become transparent. The results from the visual observations showed that a 220 μ m (carapace length) nauplius became transparent within 30 minutes, smaller nauplii becoming transparent after approximately 15-20 minutes. Fig. 5 shows a photo of 3 nauplii stained with toluidine blue all dissected out of 7 days old cod larvae, which had fed for 30 minutes. Nauplius A is negligibly affected by the process of digestion (defined as digestion category 1, (dc1)). Nauplius B has most of the soft parts dissolved (dc2) and in nauplius C

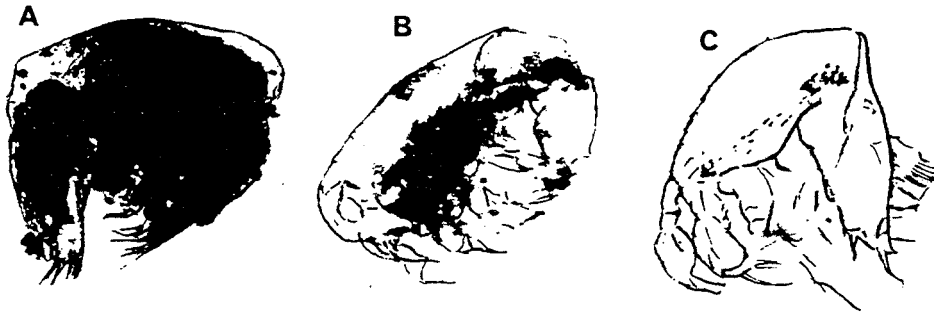

Fig. 5. Nauplii dissected from a 7 days old larvae after a 30 minutes feeding period. The nauplii are coloured with 1% toluidine blue in 1% borax prior to photographing (from Tilseth and Ellertsen, 1984b).

only the excuviae is left (dc3). The excuviae were never observed to be affected by the digestive enzymes, but often collapsed and lost appendages after a longer period of peristaltic action.

The results from the larval cod gut passage experiments are shown in Fig. 6. This experiment was run in two steps, a 1 hour feeding period followed by a 4 hour period in filtered sea water. In Fig. 6A the larval cod feeding incidence is presented, which showed a level of 56% at the start of the starvation period. This dropped to 30% within the first hour with very little variation in the following 3 hours. Fig. 6(B) shows the larval cod feeding ratio (a) (only estimated for larvae with gut content), and the volume of the digestible organic material of the prey (b) (given in arbitrary units based on the above described digestion categories, where dc1 is given the value 1.0, dc2 0.5 and dc3 0.1). Fig. 6(B) shows that the number of prey of the gut content was reduced from 2.4 nauplii/larvae gut to 1.3 nauplii/larvae gut within 2 hours, with no further reduction during the next 2 hours. The volume of the digestible organic material decreases from 0.55 to 0.13 within 90 minutes, with no further reduction. This means that only the excuviae are left.

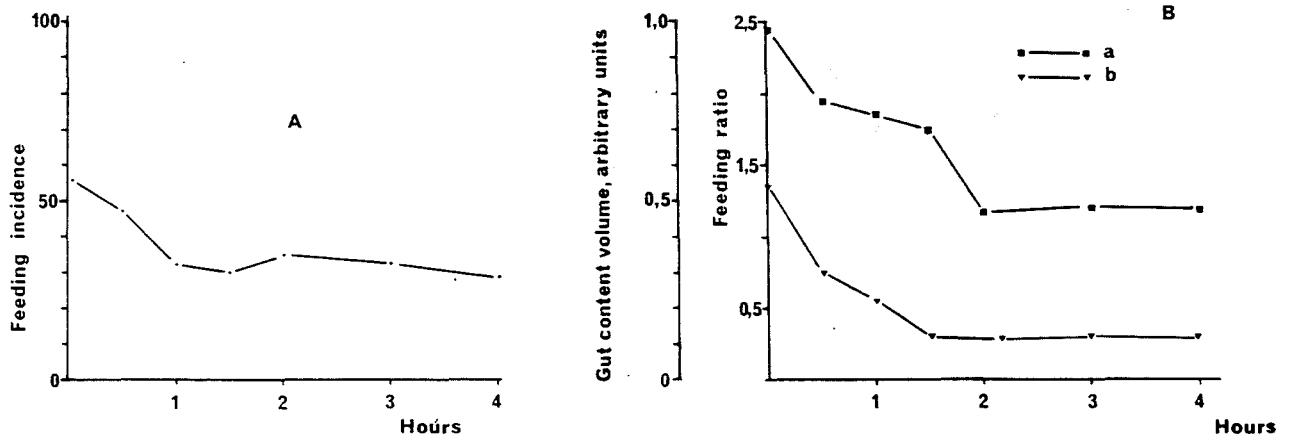

Fig. 6. Cod larval feeding incidence (A) and feeding ratio (Ba) and the volume of digestable organic material in prey (b, arbitrary units) during a 4 hour larval gut evacuation experiment (from Tilseth and Ellertsen, 1984b).

Bivalve veliger larvae (62%) and copepod nauplii (35%) dominated as prey organisms in the continuous feeding experiment, only a few rotifers, copepod eggs and phytoplankters (*Peridinium* sp) (3%) were present. The results from the larval cod gut content analysis from this experiment are presented in Fig. 7. The feeding incidence (Fig. 7A) increased to 87% in 3 hour, and varied between 80% and 93% during the next 6 hours. A reduction occurred concomitantly with the reduction in light intensity to 40% at 2330 h, showing that about 50% of the fed larval population evacuated their guts. The feeding incidence increased after midnight with increasing light intensity reaching 90% at 0530 h, varying between 77% and 90% during the next 6 hours to 1130 h when the experiment was terminated.

The larval cod feeding ratio is presented in Fig. 7B as the total number of prey (a), number of bivalve veliger (b) and number of nauplii (c) per larval gut. The feeding ratio increased from 0 prey/larval gut to 4.0 prey/larval gut in 3 hours, giving a feeding rate of 1.3 prey/larval gut per hour, more bivalve veliger were captured (2.2/larval gut) than

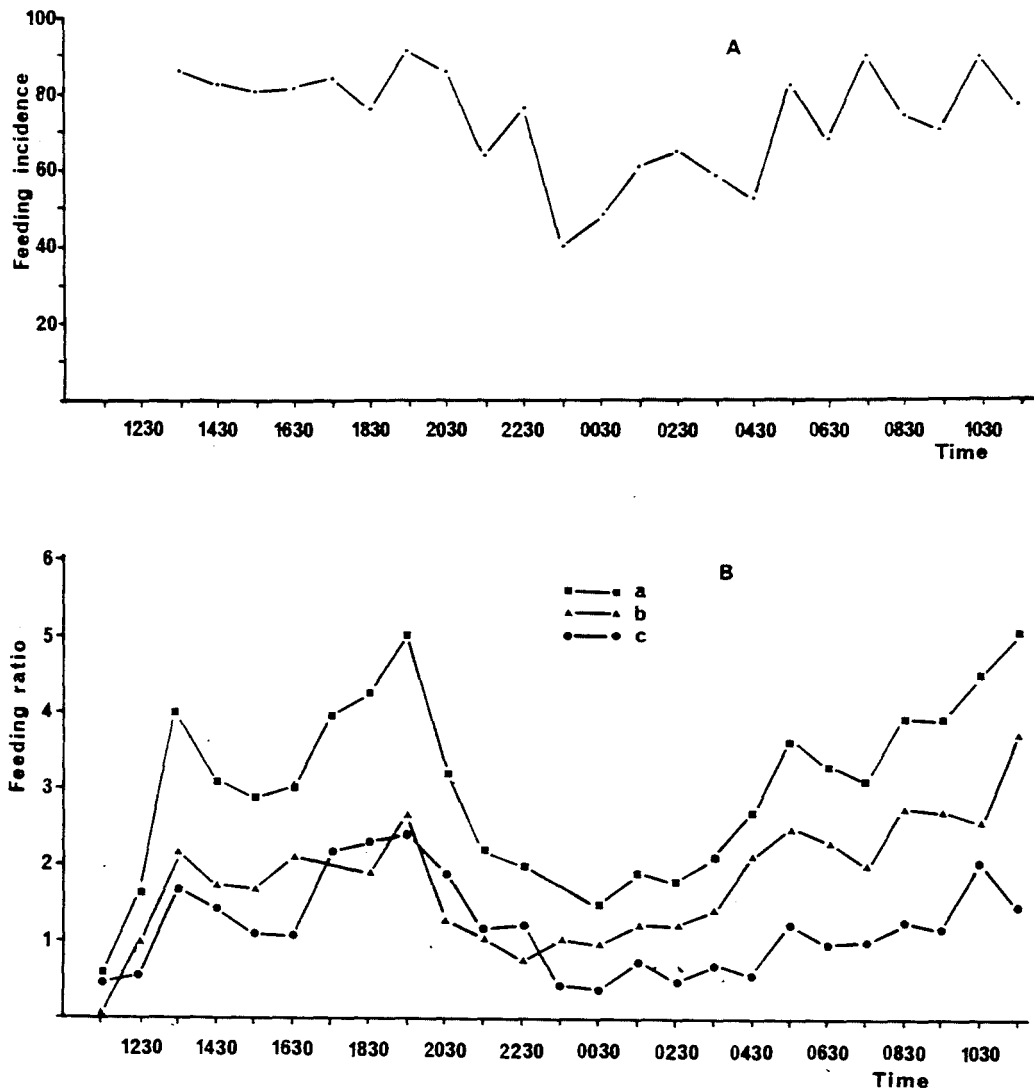

Fig. 7A. Percentage of cod larvae with stomach content (feeding incidence) during a 24 hour feeding experiment. B. Average number of prey items in the cod gut (feeding ratio) (a), the number of bivalve veligers/larval gut (b), and the number of nauplii/larval gut (c) (from Tilseth and Ellertsen, 1984b).

nauplii (1.9/larval gut). The feeding ratio dropped to 3.0 prey/larval gut in the next 3 hours, followed by an active feeding period when the feeding ratio increased to 5.1 prey/larval gut at 1930 h. More than 95% of the nauplii were completely digested and the excuviae collapsed. The bivalve veliger were with a few exceptions undigested, but were stacked like plates such that the larval gut content were filled with

undigestible prey and excuviae. The feeding ratio decreased at 1930 h to 1.6 prey/larvae gut at 0030 h, and increased to at 0530 h a peak of 3.5 prey/larval gut. The feeding ratio dropped to 2.9 prey/larvae gut at 0730 h and increased again during the next 4 hours to 5.1 prey/larval gut by 1130 h when the experiment was terminated. More bivalve veliger larvae were found in the larval gut content than copepod nauplii in samples after midnight.

Feeding Success, Perceptive Field.

The results of the larval cod feeding success experiments are presented in Table 1, showing an increase in feeding success from age 5 days post-hatching of 11.2% to 23.1% feeding success at age 7 days. The feeding success decreased to 14% with the resorption of the yolk sac at age 8 days post-hatching.

The larval cod perceptive distance increased with larval length from 3.36 mm to 3.48 mm (Table 1). No correlation could be made between the larval perceptive distance and the size of the prey. The larvae did, however, react to prey in all directions both above and below the horizontal axis of the larval body.

Table 1. Cod larval feeding success during the first days of exogenous feeding. FS; mean percent feeding success, SD; standard deviation, SL; mean larval standard length (mm), PD; mean perceptive distance (mm) and N; number of larvae.

Age	Feeding success		SL (mm)	PD (mm)	N
	FS	SD			
5	11.2	1.4	4.48	3.36	7
6	13.5	5.1	4.52	3.39	10
7	22.2	6.5	4.60	3.45	8
8	14.0	4.4	4.64	3.48	9

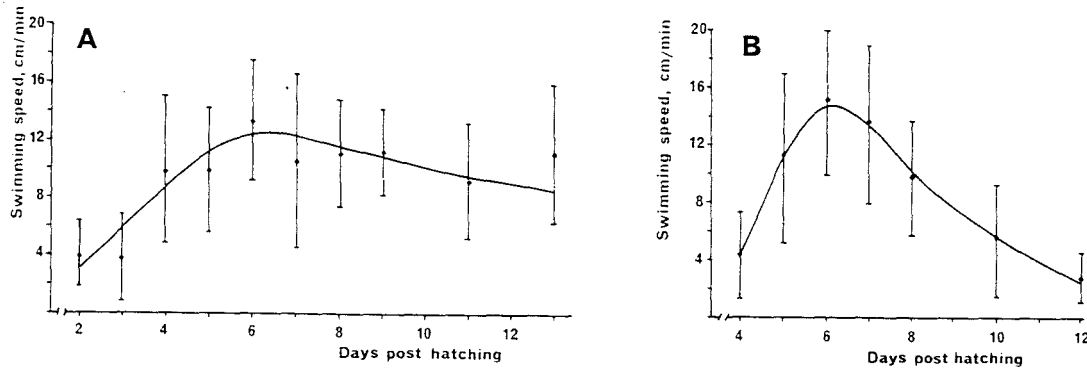

Fig. 8. Swimming speed of group A and B cod larvae (from Solberg and Tilseth, 1984).

Swimming Speed.

Fig. 8 shows the estimations of the larval cod swimming speed. These measurements were made on two different larval groups. The mean swimming speed (Fig. 8, solid line) increased in both groups from the start of the experiments to day 6 post-hatching, reaching a mean level of 12.2 cm/minute in group A larvae and 13.4 cm/minute in group B. The swimming speed decreased in both groups after day 6 to 8.2 cm/minute in group A larvae and 3.3 cm/minute in group B.

Table 2. The mean volume of water searched by the cod larvae (in liters per 24 hours) during the first 4 days of exogenous feeding, calculated from the observed variation in reactive perceptive distance and variation in swimming speed, expressed by the mean swimming speed and the standard deviations.

Age	Search volume 1/24 hour		
	\bar{X}	+SD	-SD
5	5.6	8.2	3.1
6	6.7	8.8	4.7
7	6.5	9.2	3.8
8	5.5	7.7	3.3

The volume of water searched by the cod larvae was calculated from the observations of larval reactive perceptive distance and swimming speed. The results are presented in Table 2.

Prey Density.

The food density requirements in the early stages of larval fish can be estimated from the behavioural search model outlined by Ivlev (1960), which in its simplest form requires an estimate of larval search volume, feeding success and ration:

$$N = \frac{EL \cdot F}{E_n \cdot A \cdot S \cdot FS}$$

where:

- N = density of copepod nauplii/l;
- EL = larval cod energy consumption rate, cal/larva per 24 hour;
- F = increased metabolism for food processing and larval growth (4.5);
- E_n = energy ration of a 250 μm Calanus finmarchicus nauplius (1.3 · 10⁻³ cal);
- A = proportion of energy available to the predator (0.7),
- S = larval search volume (1/24 hour), and
- FS = larval feeding success.

The larval cod energy requirements have been measured by Solberg and Tilseth (1984). These measurements were made on unfed larvae and have been corrected for increased metabolism for food processing and growth according to Lasker (1963, 1970). The energy content of prey has been calculated from Tande's (1979) data and the available energy content of the prey for larval metabolism was set to 0.7 according to Winberg (1956) and Muir and Niimi (1972).

The larval cod food density required to meet metabolic demands has been calculated for the first feeding period (Fig. 9) defined as the period from the first opportunity of exogenous feeding (day 5 post-hatching according to Ellertsen et al., 1980) to the first signs of starvation if food is not encoun-

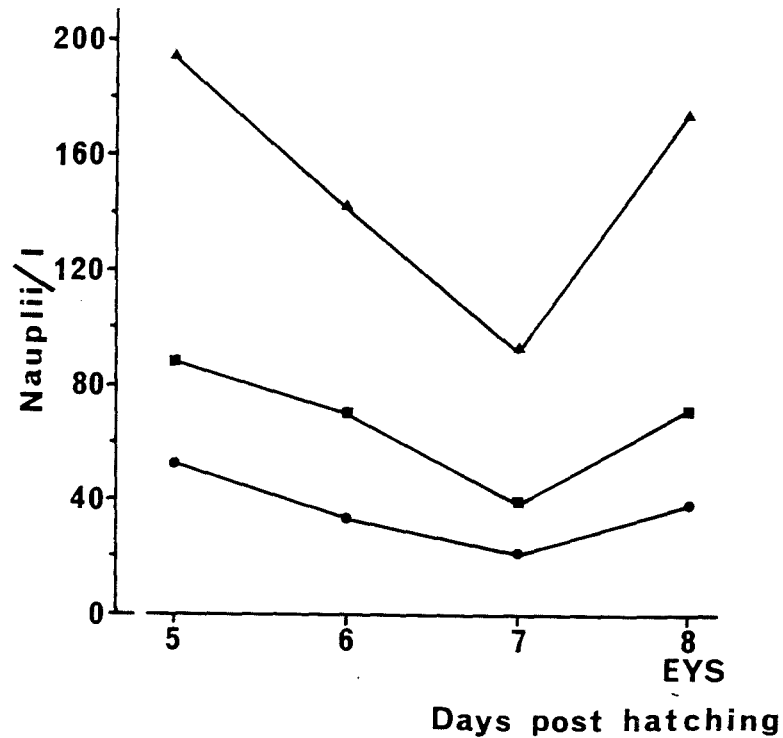

Fig. 9. Larval cod food density requirements to meet metabolic demands at the outset of exogenous feeding (day 5) to the end of yolk-sac stage (EYS). — larvae showing mean swimming speed and feeding success, Δ — Δ minimum sustained swimming speed and lower feeding success, o—o maximum sustained swimming speed and highest feeding success (from Tilseth and Solberg, 1983).

tered (day 8 post-hatching according to Solberg and Tilseth, 1984). The time available for visual feeding has been set to 24 hours according to Gjørøster and Tilseth (1982). They found the light intensity to be above the threshold for feeding in the upper 38 m of the water column during 24 hours in Lofoten in mid May.

Three different levels have been calculated according to the variation in larval swimming speed (Fig. 8) and feeding success (Table 1). The larvae with the smallest search volume and lowest feeding success require 190 nauplii/l, the fastest swimmers with highest feeding success require 52 nauplii/l, while the average larvae require 89 nauplii/l at the onset of

exogenous feeding. The requirement for food density decreases through day 6 and 7 when the larvae are most successful in capturing prey organisms and show the fastest swimming speeds. The larval cod food density requirements vary at day 7 between 21 nauplii/l to 94 nauplii/l with an average food density requirement of 40 nauplii/l to meet metabolic demands. The food density requirement increases at day 8 post-hatching due to the decrease in both larval feeding success and swimming speed, varying between 39 nauplii/l to 175 nauplii/l with an average of 72 nauplii/l.

FIELD STUDIES

The distribution of cod larvae in the Lofoten area during the first weeks of May in 1979, 1982 and 1983 is presented in Fig. 10. The occurrence of cod larvae during the same period in 1980 and 1981 was low, and larvae were only found in a few Juday net hauls. Distinctive for all three years was a similar pattern of distribution in the coastal current close to the shore with the highest concentrations of cod larvae in the Austnesfjord, Henningsvær-Hølla area and Gimsøy-Vesterålsfjord area. The amount of cod larvae found in the Lofoten area in 1983 was one order of magnitude higher than in previous years.

The distribution of copepod nauplii in the Lofoten area was investigated in 1980, -81 and -82. The results are presented Fig. 11 as the mean density of nauplii/l in the upper 40 meters of the water column. The density of nauplii varied between years, but the features of the distribution were similar to that of cod larvae in the coastal current with the highest concentrations in the Austnesfjord, Hølla-Henningsvær and Gimsøy-Vesterålsfjord area.

The vertical distribution of nauplii in the Lofoten area was investigated in detail by Tilseth and Ellertsen (1984a) in 1981. They found patches of nauplii with high densities both off the Lofoten islands (west side), in the open ocean bay of the Vesterålsfjord (Fig. 12) and in the Austnesfjord-Hølla area (Fig. 13). As shown in Fig. 12 and 13 high density nauplii

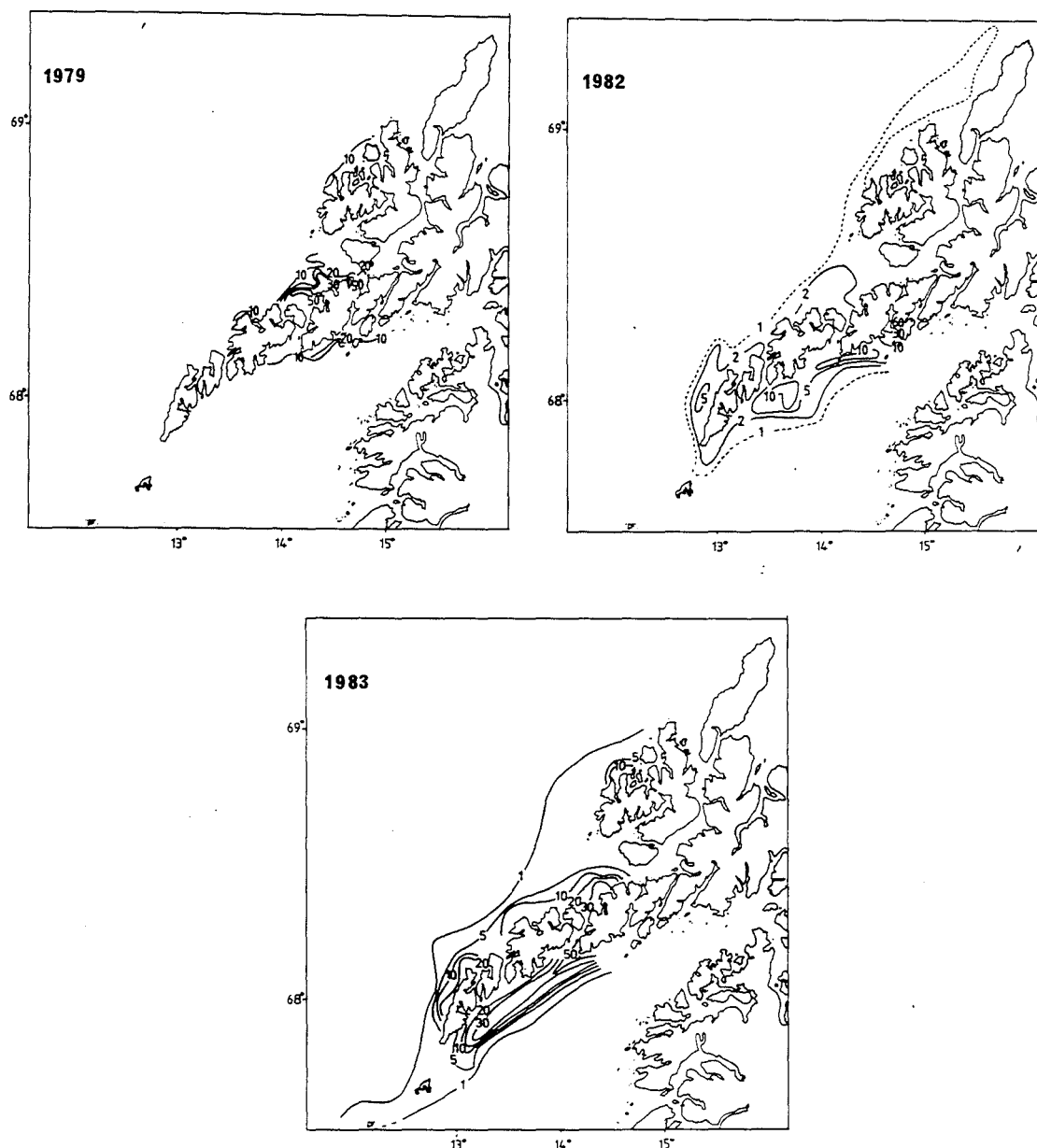

Fig. 10. The distribution of cod larvae (no. per m^2 surface) in the Lofoten area during the first 2 weeks in May in 1979, -82 and -83.

patches were more frequently found in the sheltered Austnesfjord-Hølla area than the more exposed areas west of the Lofoten islands.

Cod larvae would most probably experience different feeding conditions in these different areas. To study this aspect,

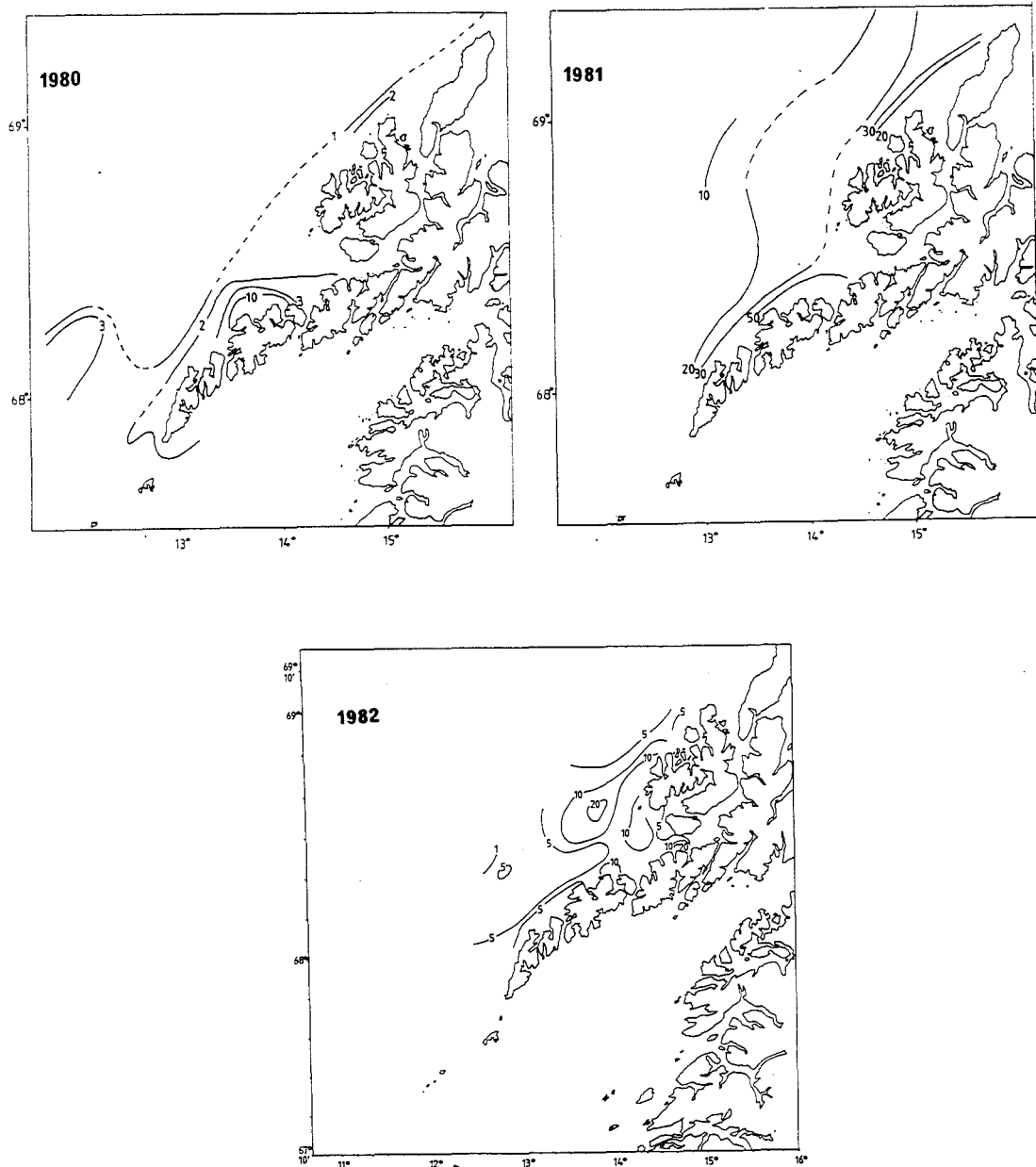

Fig. 11. The distribution of copepod nauplii (mean number per liter in the upper 40 m of the water column) in the Lofoten area during the first 2 weeks in May in 1980, 81 and 82.

samples of cod larvae from four different localities from the 1982 investigation were selected for gut content analysis. The

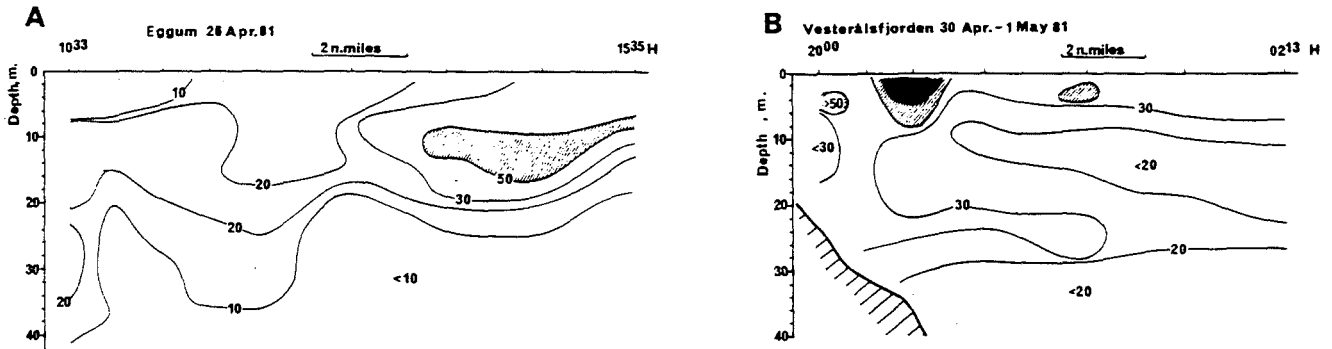

Fig. 12. The particle ($150\ \mu\text{m}$ - $500\ \mu\text{m}$) distribution (per liter) on a section west off the Lofoten islands (A) and in the Vesterålsfjord (B) (from Tilseth and Ellertsen, 1984a).

cod larvae were categorized according to the yolk-sac staging system described by Ellertsen *et al.* (1984) (see Fig. 14). The gut content analyses of cod larvae of the same stages from different areas were compared. The yolk-sac stages representing cod larvae in the first exogenous feeding stages (5 and 6) were pooled, and as well as the larval stages assumed to be in the most critical stages (7, 8 and 9).

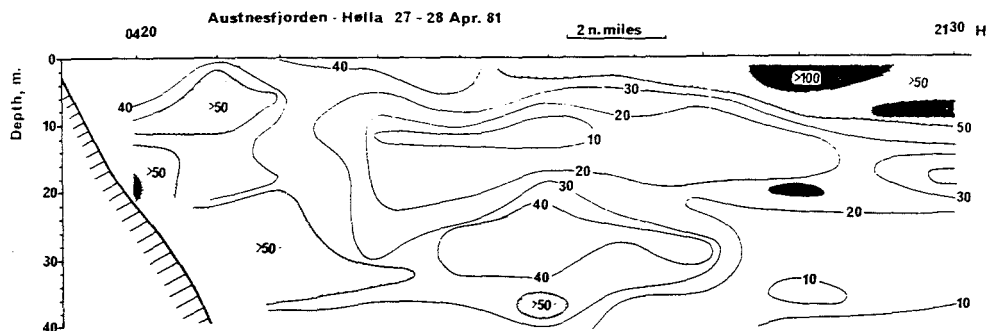

Fig. 13. The particle ($150\ \mu\text{m}$ - $500\ \mu\text{m}$) distribution (per liter) on a section from the head to the mouth of the Austnesfjord (from Tilseth and Ellertsen, 1984a).

Samples from the following areas were analysed: the Austnesfjord, the inner part of the open ocean bay of the Vesterålsfjord, the western and eastern side of the Lofoten islands (see

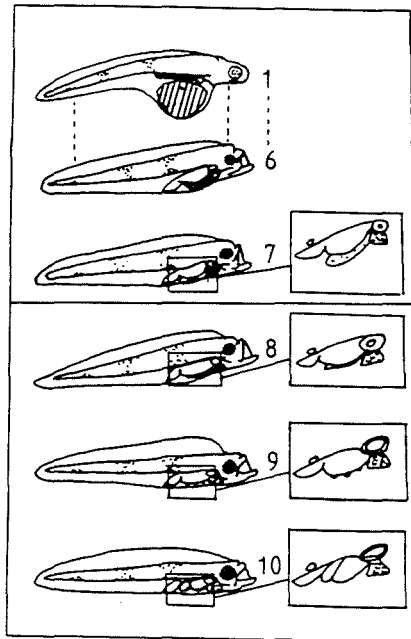

Fig. 14. The cod larval yolk-sac stages. Stage 6= remains of the yolk is present in the yolk sac; stage 7= yolk sac empty; stage 8= the membranes of the yolk sac reduced to a string; stage 9= the yolk sac membrane string partly resorbed; 10= the yolk sac membrane completely resorbed (from Ellertsen *et al.*, 1984).

Fig. 1). Samples were analysed from several time periods for the different areas. The results are presented in Fig. 15 as the larval cod feeding incidence and feeding ratio. Since the cod larvae were sampled in vertical Juday net hauls the densities of nauplii in the different areas are given as the mean nauplii density in the upper 40 meters of the water column during the time period when the samples were taken.

The Austnesfjord showed the highest average food density (5-20 nauplii/l), and the larval cod feeding incidence varied between 87% and 98% for the oldest larvae (stage 7-9) whereas the youngest larvae examined (stages 5 and 6) showed a feeding incidence between 41% to 45%. The feeding incidence of the oldest larvae from the Vesterålsfjord varied between 82% to 88%, whereas that of the youngest larvae was only between 10% to 30%. The average nauplii density in the area varied between

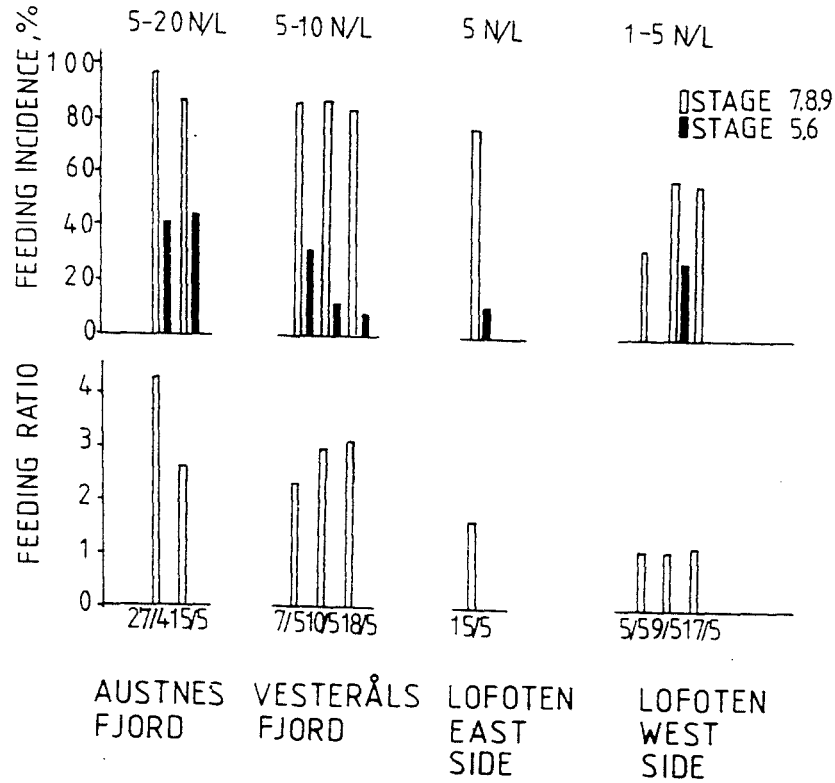

Fig. 15. Gut content analysis of cod larvae presented as feeding incidence (A) and feeding ratio (B) from four different localities in the Lofoten area (from Ellertsen *et al.*, 1984).

5-10 nauplii/l. One sample from the east side of the Lofoten islands showed 78% feeding incidence for the older larvae and 11% for the youngest larvae. The gut content analysis of cod larvae from the west side of the Lofoten islands showed a feeding incidence between 30% and 57%. The youngest larvae in these samples had not been able to capture nauplii at all except for larvae in one sample from 9 May when 23% of the youngest larvae were found with gut content. The average nauplii density in this area varied between 1-5 nauplii/l.

The larval cod feeding ratio has been calculated only for the oldest larvae from the different areas. The results are presented in Fig. 15(B) showing a larval feeding ratio between 2.5 nauplii/larval gut and 4.2 nauplii/larval gut in samples from the Austnesfjord, between 2.4 nauplii/larval gut and 3.2 nauplii/larval gut in the Vesterålsfjord, 1.6 nauplii/larval

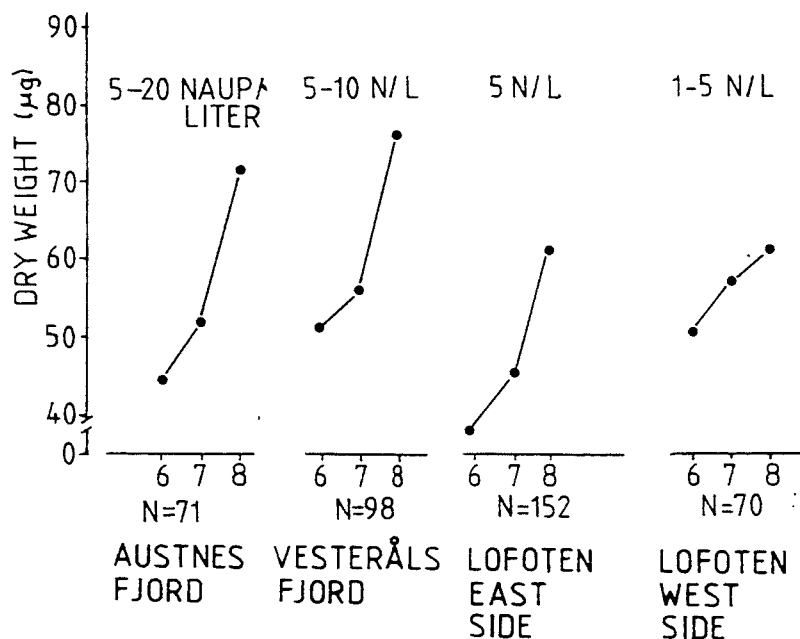

Fig. 16. The dry weight of cod larvae in stages 6, 7 and 8, from four different localities in the Lofoten area.

gut in samples from Lofoten east side and varying between 0.9 nauplii/larval gut to 1.0 nauplii/larval gut in samples from the west side of the Lofoten islands.

The dry weights of larval cod stages 6-8 are compared from the four different areas. The results are presented in Fig. 16, indicating a better growth for the larvae in the Austnesfjord and the Vesterålsfjord. The mean dry weight of stage 8 larvae was 72 µg and 75 µg respectively in these areas compared to 59 µg in samples from Lofoten east side and 56 µg from Lofoten west side, which was significantly lower ($p=0.05$, t-test) than for larvae from the Austnesfjord and Vesterålsfjord. The variation in dry weight was smallest in larvae sampled from the east side of the Lofoten islands.

The effect of wind velocity (m^2s^{-2}) on the static stability of the water masses (squared Brunt-Väisälä frequencies) and the vertical distribution of nauplii (no/l) and cod larvae (no/l), were studied during 24-hour stations. These observations were

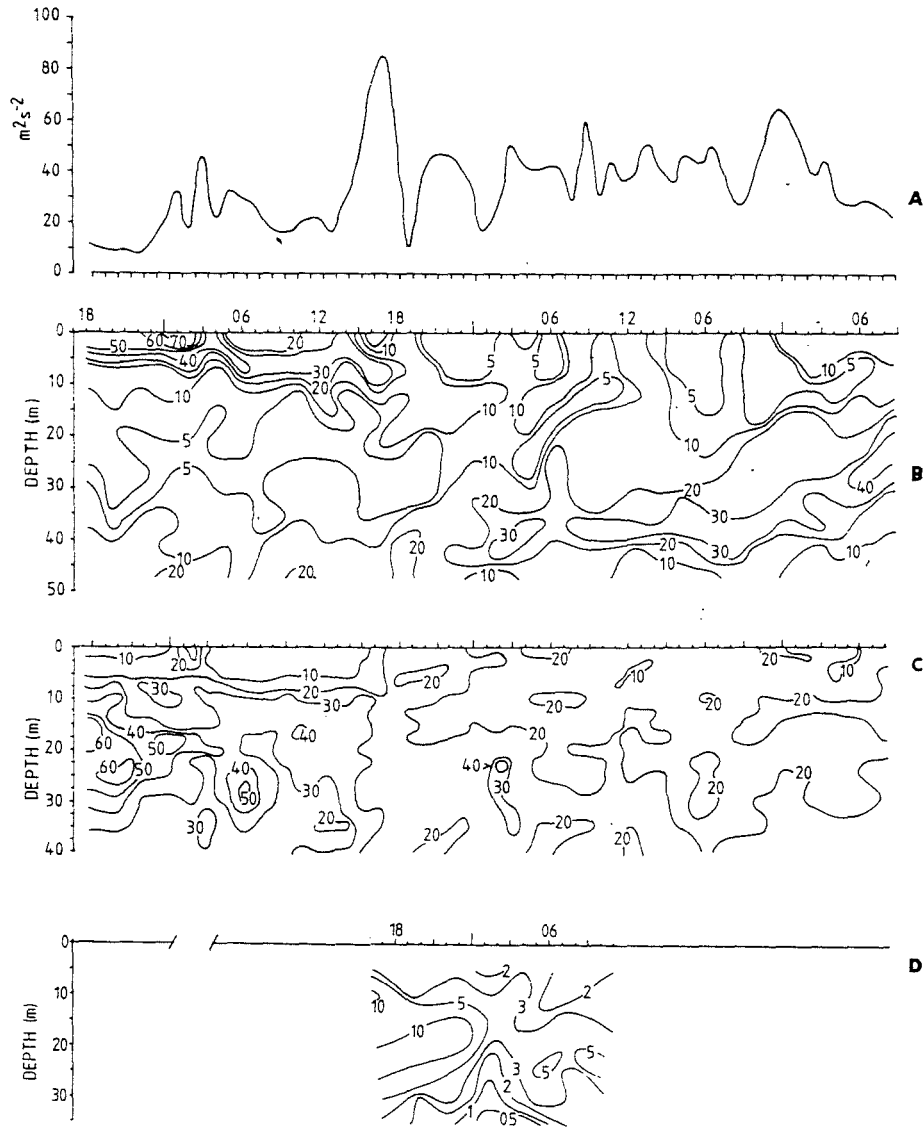

Fig. 17. Wind velocity ($\text{m}^2 \cdot \text{s}^{-2}$) A, static water stability, (squared Brunt-Väisälä frequency) B, concentration of nauplii (per liter) C and the concentration of cod larvae D during a 24 hour station in the Austnesfjord in May 1980 (from Ellertsen et al., 1984).

made in the Austnesfjord in 1980 (data from Tilseth and Ellertsen, 1984a) and in the Vesterålsfjord in 1982 (data from Ellertsen et al., 1984). The results are presented in Fig. 17 and 18.

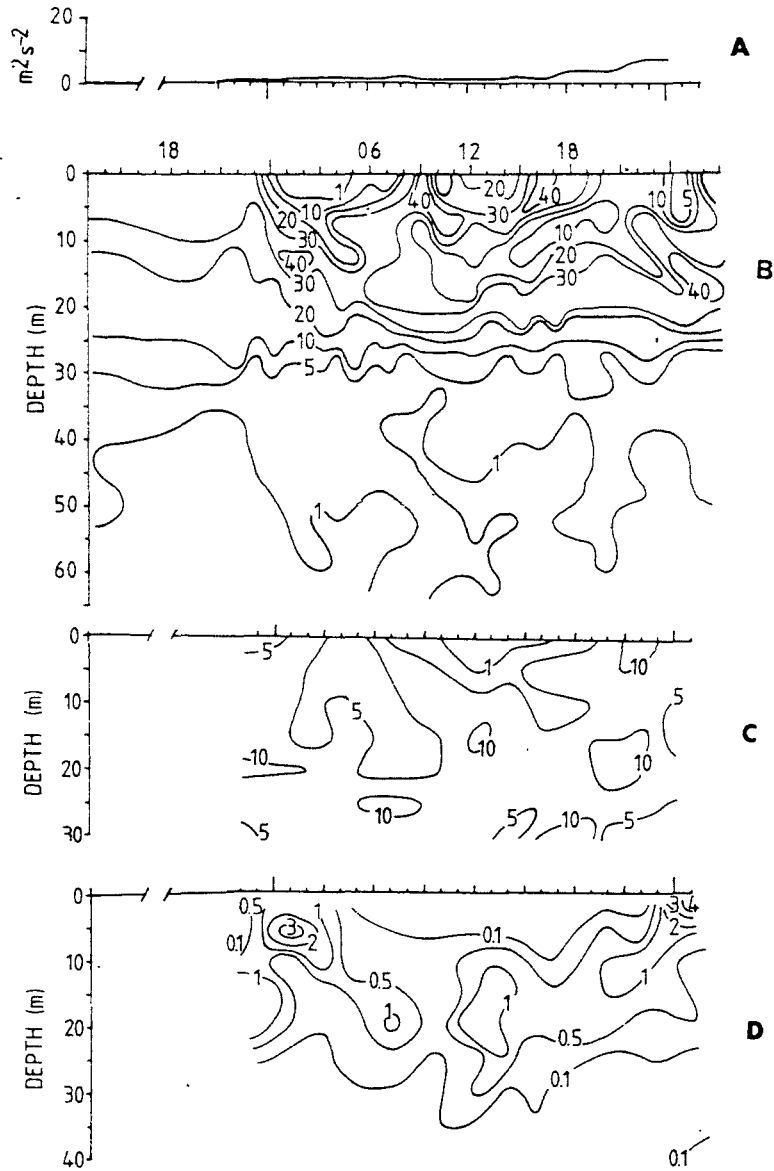

Fig. 18. Wind velocity ($\text{m}^2 \cdot \text{s}^{-2}$) A, water static stability (squared Brunt-Väisälä frequency) B, concentration of nauplii (per liter) C and the concentration of cod larvae D during a 24 hour station in the Vesterålsfjord in May 1982 (from Ellertsen *et al.*, 1984).

The wind was blowing up the fjord with varying velocities during the observations in May 1980 in the Austnesfjord (Fig. 17A). The surface water became completely mixed within 24 hours, demonstrated by the sudden decrease in squared Brunt-Väisälä frequencies at 1800 h (Fig 16B). Prior to this event nauplii were found in patches with densities >60 nauplii/l.

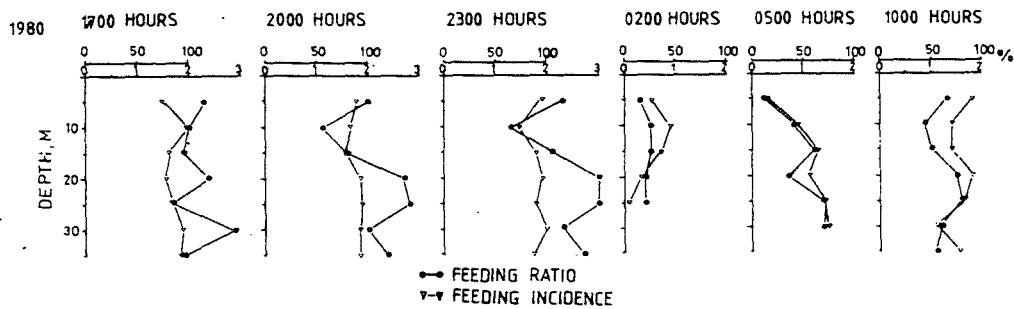

Fig. 19. Cod larval feeding incidence (∇ — ∇) and feeding ratio (o—o) during the 24 hour station the Austnesfjord in May 1980 (from Ellertsen *et al.*, 1984).

The mixing of the upper layer broke up the nauplii patches and the distribution became more or less homogenous varying between 10 nauplii/l to 20 nauplii/l (Fig. 17C). No diel vertical migration could be observed, neither of nauplii nor of cod larvae (Fig. 17D).

The wind velocity was too low during the 24-hour station in the Vesterålsfjord (Fig. 18A) to disrupt the static stability of the upper layer (Fig. 18B). Diel vertical migrations were observed both in the distribution of nauplii (Fig. 17C) and the larval cod distribution (Fig. 17D). Both the cod larvae and their main prey organisms showed vertical migration towards the surface at midnight.

The results from the gut content analysis of cod larvae from the 24-hour station in the Austnesfjord are presented in Fig. 19 as larval feeding incidence and feeding ratio. The feeding incidence varied between 73% and 100% in samples taken before vertical mixing (1700 h to 300 h, see Fig. 17B); larval feeding ratio was ≥ 1 prey/larvae gut in all of these samples, ≥ 2 prey/larval gut in 71% of the samples and ≥ 3 prey/larval gut in 14% of the samples. The feeding incidence varied between 4% and 92% in samples taken after the mixing of the surface layers. The feeding ratio was < 1 prey/larval gut in all samples taken at 0200 h and < 2 prey/larval gut in all samples

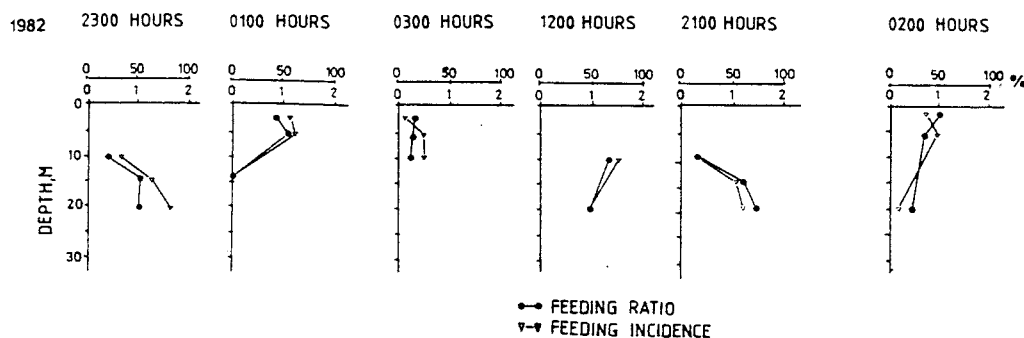

Fig. 20. Cod larval feeding incidence (∇ — ∇) and feeding ratio (o—o) during the 24 hour station in the Vesterålsfjord in May 1982 (from Ellertsen *et al.*, 1984).

after the mixing of the upper 40 meter of the watermasses. The highest cod larval feeding ratio observed after mixing was 1.65 prey/larval gut, found in one sample from 25 m depth at 1000 h. The highest larval cod feeding ratio was found in samples from 20-30 meters depths.

The results of the gut content analyses of cod larvae from the 24-hour station in the Vesterålsfjord are presented in Fig. 20. The larval feeding incidence varied between 35% and 61%. The highest feeding incidence (59% - 61%) was found in samples from 20 m depth at 2300 h and 10 m depth at 1230 h. The larval feeding ratio varied between 0 prey/larval gut to 1.5 prey/larval gut. Larvae with empty guts were found in one sample from 20 m depth at 0130 h and the highest feeding ratio was found in larvae from 10 m depth at 1230 h.

DISCUSSION

Gut content analyses of field sampled cod larvae and plankton enables conclusions to be drawn on the selection of prey species and size. This has been done for cod larvae in field studies by Wiborg (1948) who demonstrated a linear relationship between larval mouth size and prey width. Ellertsen *et al.* (1977) showed that the cod larvae, in the Lofoten area, were

more size selective than species selective, and that the sizes most frequently captured were within 140 μ m-600 μ m. The main prey organism found from gut content analysis were nauplii of the copepod Calanus finmarchicus, the most dominant available prey in Lofoten (Wiborg, 1948; Ellertsen *et al.*, 1981) during the main larval cod first feeding period (Ellertsen *et al.*, 1977).

Conclusions on the larval cod feeding conditions in sea must be based on the knowledge of larval feeding rate, gut passage rate and the digestability of different prey. These important ecological features were previously not well known. The larval feeding experiments presented in this study were performed under expected optimum levels both with regard to light conditions (Ellertsen *et al.*, 1980) and prey density (Solberg and Tilseth, 1984). The results (Fig. 7) suggest that when the feeding conditions are optimal cod larvae are sporadic feeders pausing between feeding to digest food. Other fish larvae are known to be continuous feeders (largemouth bass, Micropterus salmoides, Laurence, 1971) and herring (Clupea harengus, Werner and Blaxter, 1981). This difference could be due to the relative small volume and rapid digestion rate in cod larvae varying from 30-90 minutes depending on the volume of digestable gut content (Fig. 6B). The larval feeding rate is obviously dependent on this strategy of feeding showing a linear increase in number of prey captured until gut maximum filling is reaching (Fig. 4 and Fig. 7). The maximum gut filling seem to be a function of volume or state of digestion of the gut content. This is demonstrated in Fig. 7B, showing that, when the larvae had continuous access to food, the number of prey in the gut increased in two steps from 0 prey/larval gut to 4.0 prey/larval gut interrupted by a digestion period then increasing again to 5.1 prey/larval gut. This was probably the maximum gut filling when over half of the completely digested contents consisted of undigestable bivalve veliger larvae.

Cod larvae do not seem to evacuate the gut at a constant rate, but at intervals (Fig. 7B) and only completely when maximum filling is reached. During periods of starvation the larvae

would not empty the gut completely but retained the gut content for several hours (Fig. 6B). These observations have been applied to define criteria for the analysis of larval cod gut content for evaluation of the feeding conditions in the sea by Tilseth and Ellertsen (1984b). They suggest that the larval cod feeding incidence (defined as the percentage of larvae with gut content) should be treated with care. A high feeding incidence does not necessarily indicate good feeding conditions, because cod larvae could keep parts of the gut content for several hours when the accessibility of food is reduced. In larval gut content analysis the feeding incidence should be estimated in concert with the larval feeding ratio. The magnitude of the feeding ratio indicate how close the larvae are to their maximum gut filling. Consequently a feeding ratio ≥ 3 nauplii/ larval gut and a feeding incidence $>90\%$ indicate good feeding conditions at the time and place of capture. A feeding incidence $\geq 50\%$ and a feeding ratio $\geq 1 \leq 2$ nauplii/larval gut and if no newly eaten copepod nauplii are found in the gut content, then there is good reasons to believe that the larval population have been starving for several hours.

The results of the gut content analyses of cod larvae from four localities in the Lofoten area showed that the larval cod feeding incidence varied in proportion to the nauplii density. The highest feeding incidence was found in the sheltered localities, the Austnesfjord and the Vesterålsfjord, while the lowest larval feeding incidence was found in the most exposed areas with lowest food density (1-5 nauplii/l) west of the Lofoten islands. These differences in larval feeding incidence became even more clear when the youngest first feeding stages (stage 5 and 6) were compared. Except for one sample, these larvae had not been able to feed at all when the average nauplii density was 1 nauplii to 5 nauplii/l as observed west of the Lofoten islands. When comparing the larval feeding ratio it was evident that the Austnesfjord and the Vesterålsfjord provided the best feeding conditions. Only in samples from these localities were cod larvae found with gut content close to gut maximum filling (>3 nauplii/larval gut, Fig. 15B). In these areas the larval feeding incidence was $>80\%$ in all

samples and the feeding ratio was >3 nauplii/larval gut in more than 50% of the samples. The cod larvae sampled west of the Lofoten islands must have been starving for several hours prior to sampling judging by the low feeding incidence, $<50\%$, and low feeding ratio, <1 nauplii/larval gut. Evidence presented in Fig. 16, shows a lower dry weight in larvae from this region than those from the Austnesfjord and the Vesterålsfjord, indicating that poor feeding conditions probably had existed for several days.

Patches of nauplii with densities exceeding larval cod density requirement to meet metabolic needs was found in the first feeding area (Fig. 12, 13), the size of these patches were small compared to the volume of water surveyed. They were, however, more frequently encountered in sheltered areas than exposed ones (Tilseth and Ellertsen, 1984a).

Detailed observations of the vertical distribution of cod larvae and nauplii with synoptic observation on wind force and the static stability of the water column are necessary for a better understanding between these biological and physical parameters. Such observations were made in the Austnesfjord, showing that increased vertical mixing with increasing wind force lead to a homogenous distribution of nauplii in the upper 40 m of the watercolumn (Fig. 17C) and no diurnal vertical migration could be observed neither in nauplii nor in cod larvae (Fig. 17D). The mixing of the surface layers and reduction in nauplii density caused a reduction in both feeding incidence and feeding ratio (Fig. 19). Prior to breakdown in water stability nauplii patches with densities between 40 nauplii/l and 60 nauplii/l were observed. This is close to the estimated average food density requirement for first feeding cod larvae (Fig. 9), and one should expect good feeding conditions. This was supported by the gut content analysis (Fig. 19), showing a larval feeding incidence between 90% - 100% and a feeding ratio ≥ 3 nauplii/larval gut (close to maximum gut filling) in the majority of samples. During the first few hours after the break down in water stability, the larval feeding conditions became poorer judging by the gut

content analyses, showing a feeding incidence $<45\%$ and feeding ratio <1 nauplii/larval gut. The nauplii density varied between 10-20 nauplii/larval gut, which is close to the estimated critical prey density (about 20 nauplii/l, Fig. 9). This clearly indicates a diminished accessibility of food for the cod larvae.

When the upper surface layer of the water column remains stable for more than 24 hours, as observed during the diurnal station in the Vesterålsfjord, vertical migration was found both in cod larvae and copepod nauplii (Fig. 18). The nauplii density was not more than 1 nauplii/l to 10 nauplii/l, and only small patches with more than 10 nauplii/l were observed, still below estimated critical density (Fig. 9). The results from the gut content analysis (Fig. 20) showed a feeding incidence between 10% to 50% and a feeding ratio ≥ 1.0 nauplii/larval gut in most of the samples. This indicate poor feeding conditions for the cod larvae in the Vesterålsfjord even if there was no or very little turbulence in the water column.

These observations supports Hjort's (1914) hypothesis and the hypothesis of Vlymen (1977) that fish larvae depend on small scale patchiness with high concentrations to meet their metabolic requirement. The rate of survival of the larval population and thereby the contribution to the yearclass strength could be dependent on the biological and physical factors affecting the distribution, frequency and stability of dense patches of larval cod food organisms.

REFERENCES

- Ellertsen, B., Moksness, E., Solemdal, P., Strømme, T., Tilleseth, S., Westgård, T. and Øiestad, V., 1977. Vertical distribution and feeding of cod larvae in relation to occurrence and size of prey organisms. Coun. Meet. int. Coun. Explor. Sea, (F:34) 31 pp Mimeo.

- Ellertsen, B., Moksness, E., Solemdal, P., Strømme, T., Tilseth, S., Westgård, T. and Øiestad, V., 1980. Some biological aspects of cod larvae (*Gadus morhua* L.). Fisk.Dir. Skr. Ser. HavUnders., 17: 29-47.
- Ellertsen, B., Solemdal, P., Sundby, S., Tilseth, S., Westgård, T. and Øiestad, V., 1981. Feeding and vertical distribution of cod larvae in relation to availability of prey organisms. Rapp. P.-v. Cons. int Explor Mer, 178:
- Ellertsen, B., Fossum, P., Solemdal, P., Sundby, S., and Tilseth, S. 1984. A case study on the distribution of cod larvae and availability of prey organisms in relation to physical processes in Lofoten. In: E. Dahl, D.S. Danielssen, E. Moksness and P. Solemdal (Eds). The Propagation of Cod Gadus morhua L. Flødevigen rapportser., 1, 1984.
- Gjøsæter, J. and Tilseth, S., 1982. Primary growth increments in otoliths of cod larvae (*Gadus morhua* L.) of the Arctic-Norwegian stock. Fisk.Dir. Skr. Ser. HavUnders., 17: 278-295.
- Hjort, J., 1914. Fluctuations in the great fisheries of northern Europe viewed in the light of biological research. Rapp. P.-v. Réun. Cons. Perm. int. Explor. Mer. 20: 1-228.
- Houde, E.D., 1978. Critical food concentrations for larvae of three species of sub-tropical marine fishes. Bull. Mar. Sci. 28: 395-411.

- Hunter, J. and Thomas, G.L., 1974. Effect of prey distribution and density on the searching and feeding behaviour of larval anchovy *Engraulis mordax* Girard. In: J.H.S. Blaxter (Editor), *The Early Life History of Fish*. Springer-Verlag, Berlin.
- Ivlev, V.S., 1960. On the utilization of food by planktophage fish. *Bull. Math. Biophysics*. 22: 371-389.
- Lasker, R., 1963. The physiology of Pacific sardine embryos and larvae. *Cal. Coop. Oceanic Fish. Invest.*, X: 96-101.
- Lasker, R., 1970. Utilization of zooplankton energy by Pacific sardine population in California current. In: J.H. Steele (Editor), *Marine Food Chains*. Oliver and Boyd publ. cop. Edinb.
- Lasker, R. and Zweifel, J.R., 1978. Growth and survival of first-feeding northern anchovy (*Engraulis mordax*) in patches containing different proportions of large and small prey. In: J.H. Steele (Editor), *Spatial Pattern in Plankton Communities*. Plenum, New York, 470 pp.
- Lasker, R., Feder, H.M., Theilacker, G.H. and May, R., 1970. Feeding, growth and survival of *Engraulis mordax* larvae reared in the laboratory. *Mar. Biol.* 5: 345-353.
- Last, J.M., 1978. The food of three species of gadoid larvae in the eastern English channel and southern North Sea. *Mar. Biol.*, 48: 377-386.
- Laurence, G.C., 1971. Digestion rate of larval largemouth bass. *N.Y. Fish Game J.*, 18: 52-56.
- 1974. Growth and survival of haddock (*Melanogrammus aeglefinus*) larvae in relation to planktonic prey

- concentrations. J. Fish. Res. Bd. Canada 31: 1415-1419.
- 1977. A bioenergetic model for the analysis of feeding and survival potential of winter flounder, *Pseudopleuronectes americanus*, larvae during the period from hatching to metamorphosis. U.S. Fish. Bull. 75: 529-546.
- Marak, R.R., 1960. Food habits of larval cod, haddock and coalfish in the Gulf of Manine and Georges Bark area. J. Cons. Perm. int. Explor. Mer. 25: 147-157.
- May, R.C. 1974. Larval mortality in marine fishes and the critical period concept. In: J.H.S. Blaxter (Editor), The Early Life History of Fish. Springer-Verlag, New York.
- Muiir, B.S. and Niimi, A.J., 1972. Oxygen consumption of the euryhaline fish aholehole (*Kuhlia sandvicensis*) with reference to salinity, swimming and food consumption. J. Fish. Res. Bd, Canada, 23: 1209-1248.
- Phillips, O.M. 1977. Dynamics of the Upper Ocean. Cambridge University Press Cambridge. pp 207-209.
- Rosenthal, H. and Hempel, G., 1970. Experimental studies in feeding and food requirements of herring larvae (*Clupea harengus* L.). In: J.H. Steele (Editor), Marine Food Chains. Univ. Calif. Press, Berkely.
- Solemdal, P. and Ellertsen, B., 1984. Sampling fish larvae pumps; quantitative comparisons with traditional gear. In: E. Dahl, D.S. Danielssen, E. Moksness and P. Solemdal (Eds.). The Propagation of Cod Gadus morhua L. Flødevigen rapportser., 1, 1984.
- Tande, K.S., 1979. Populationsdynamikk, reproduksjonsstrategi, karbon-nitrogeninnhold og vekst hos kopepoden calanus

finmarchicus (Gunnerus) i Balsfjorden, Nord-Norge. Hovedoppgave i marinbiologi. Inst. for biologi og geologi. Univ. i Tromsø. Mimeo.

- Tilseth, S. and Ellertsen, B., 1984a. The detection and distribution of larval Arcto-Norwegian cod, Gadus morhua, food organisms by an in situ particle counter. U.S. Fishery Bulletin: 82(1) in press.
- Tilseth, S. and Ellertsen, B., 1984b. First feeding cod larvae (Gadus morhua L.) food consumption rate and gut evacuation processes. In: E. Dahl, D.S. Danielssen, E. Moksness and P. Solemdal (Eds.). The Propagation of Cod Gadus morhua L. Flødevigen rapportser., 1, 1984.
- Solberg, T. and Tilseth, S., 1984. Growth, energy consumption and prey density requirements in first feeding larvae of cod (Gadus morhua L. In: E. Dahl, D.S. Danielssen, E. Moksness and P. Solemdal (Eds.). Flødevigen rapportser., 1, 1984.
- Tilseth, S., Solberg, T. and Westrheim, K., 1984. Sublethal effects of the water-soluble fraction of Ekofisk crude oil on the early larval stages of cod (Gadus morhua L.) Marine Environmental Research, (In press).
- Vlymen, W.J.III. 1977. A mathematical model of the relationship between larval anchovy (Engraulis mordax) growth, prey microdistribution, and larval behaviour. Environ. Biol. Fishes. 2: 211-233.
- Werner, R.G. and Blaxter, J.H.S., 1981. The effect of prey density on mortality, growth and food consumption in larval herring (Clupea harengus L.) Rapp. P.-v. Réun. Cons. int. Explor. Mer, 178: 405-408.

- Wiborg, K.F., 1948. Investigations on cod larvae in the coastal waters of northern Norway. Fisk.Dir. Skr. Ser. HavUnders. 9(3) 27 pp.
- Winberg, G.G., 1956. Rate of metabolism and food requirements of fishes. Beloruss. State. Univ., Minsk. Fish. Res. Bd Can., Transl. Ser. No. 194 (1960).
- Wyatt, T. 1972. Some effects of food density on growth and behaviour of plaice larvae. Mar. Biol. 14: 210-216.