

Fol. 41 k

Handwritten
Bibliotek

This report not to be quoted without prior reference to the Council*

International Council for the
Exploration of the Sea

C.M.1994/L:12

REPORT OF THE WORKING GROUP ON RECRUITMENT PROCESSES

Lysekil, Sweden 14-17 June 1994

This document is a report of a Working Group of the International Council for the Exploration of the Sea and does not necessarily represent the views of the Council. Therefore, it should not be quoted without consultation with the General Secretary.

*General Secretary
ICES
Palægade 2-4
DK-1261 Copenhagen K
DENMARK

3116/6 2299

TABLE OF CONTENTS

Section	Page
1. TERMS OF REFERENCE AND PARTICIPANTS	3
2. OVERVIEW OF THE MEETING	4
3. CONCLUSIONS	6
4. RECOMMENDATIONS	7
5. REPORTS ON INDIVIDUAL DISCUSSION TOPICS	8
6. REFERENCES	21
APPENDIX 1: The Basis of Simple Growth Models by J.E. Beyer	23
APPENDIX 2: A Model of Compensatory Growth in Fish and its Application to Fish Larvae by M. Heath	28
APPENDIX 3: A Model of Otolith and Larval Fish Growth by H. Mosegaard	34
APPENDIX 4: A Brief Chronology of the Advances in Size Based Theory prepared by E. Houde	39
APPENDIX 5: Basic Equations in Size Based Ecosystem Analysis prepared by E.Houde	42
APPENDIX 6: Agenda for the Working Group Meeting	43
TABLES 1-2	44
FIGURES 1-9	46

I. TERMS OF REFERENCE AND PARTICIPANTS

At the 1993 ICES Statutory Meeting, resolution 2:54 was adopted as follows:

The Working Group on Recruitment processes (Chairman: Dr M. Heath, UK) will meet in Lysekil, Sweden from 14-17 June 1994 to:

- a) Review ongoing work in connection with the cod and haddock checklist.
- b) Assemble and analyse data on the inter-species and inter-regional variability in growth of fish larvae.
- c) Critically review and refine the performance of a candidate set of larval growth models, with reference to Norwegian data on larval cod.
- d) Review progress on the development of an analytical model of otolith increment formation.
- e) Review progress on interpreting temperature histories of larvae from otolith elemental and isotopic analysis.
- f) Review results of studies examining the relationships between larval size, growth, and mortality rates.
- g) Consider the implications of the report of the Study Group on Methods of Spatial and Temporal Integration for the design and conduct of field investigations of recruitment processes.

The meeting was attended by the following:

J Anderson	Canada	T Linkowski	Poland
J Beyer	Denmark	J Modin	Sweden
S Campana	Canada	E Moksness	Norway
P Fossum	Norway	H Mosegaard	Sweden
C Fox	UK	P Munk	Denmark
M Heath	UK (Chairman)	D Schnack	Germany
E Houde	USA	P Solemdal	Norway
P Karås	Sweden		

The Chairman received apologies from the following:

J Gagne	Canada	W Nellen	Germany
A Garcia	Spain	M Stehmann	Germany
F Lagardere	France	S Tilseth	Norway

II. OVERVIEW OF THE MEETING

II.1 Introduction

The Working Group was able to address all the assigned terms of reference to varying degrees of detail. There were three main areas of work in progress. First, reviewing the state of the art in elemental analysis of otoliths and studies of vital rates in fish life stages. Secondly, evaluation and development of an action plan following on from the report of the Study Group on Spatial and Temporal Integration. Finally, assembly and analysis of data on otoliths and body size for a range of species of fish larvae, alongside review and development of models of fish growth.

II.2 Progress with the Cod Checklist

The WG approved the final draft of the cod checklist for publication as an ICES Cooperative Research Report with a few minor changes. The WG recognised the time commitment that had been necessary to bring this task to its present state and concluded that it had been an important exercise. Recommendations were made concerning updating the document at some future date, and repeating the exercise for other species.

II.3 Development of Models of Larval Fish Growth

The report from the previous meeting of the WG (CM 1992/L:6) set an agenda for intersessional work on coding and evaluation of growth models of fish larvae, linked to mesocosm data on cod larvae available from Norway and previously summarised in ICES CM 1989/EMEM:1. For a variety of reasons the focus was shifted to models of otolith growth in preparation for a more concerted effort on linking otolith growth to body growth. The meeting briefly reviewed the different approaches to growth modelling and identified three related parallel tracks of model development. The first track focused on modelling of somatic growth in terms of environmental factors. The second track concentrated on explicit modelling of otolith growth, and the final track on models which link together otolith and somatic growth. The WG was presented with examples in varying operational states and of varying complexity from the first and last categories, but could not report any progress in the second category, due mainly to a lack of knowledge of the underpinning physiology. During the meeting, a sub-group of members focused on the development of an analytical model linking otolith and somatic growth, taking advantage of the opportunity to interact directly with the assembled data on otolith morphometrics and allometry.

II.4 Analysis of Fish Larvae Otolith Data

A substantial amount of data on otolith size and microstructure, and body size of cod, sprat, herring, smelt and sandeel larvae was assembled prior to the meeting. These were compiled into a coherent format during the meeting and subjected to various analyses. The types of analysis were to a large degree directed by the requirements of a sub-group of the WG engaged in evaluation and formulation a model of somatic and otolith growth. The first level of analysis showed that the familiar relationships between otolith size and body size established for many species were expressed in the data available to the WG. Subsequently, the widths of outer increments in smelt, herring and sandeel otoliths were related to body size, otolith size and temperature as the basis for an analytical model linking otolith growth and somatic growth. The bringing together of modelling interests,

field practitioners and data during the WG meeting was an exciting new development for the WG, and it is proposed that this should be sustained by a Workshop during 1996, subject to some further preliminary work by WG members.

II.5 State of the Art in Otolith Elemental Analysis

The WG was presented with a review of the state of the art in elemental analysis of otoliths, prepared beforehand by one of the members (S. Campana, Canada), which indicated that this field is probably on the verge of providing some major new tools for studying fish and fish populations. Six major applications have emerged which take advantage of recent advances in otolith trace element analysis: 1) chemical mass marking; 2) radiochemical dating; 3) pollution indices; 4) stock identification; 5) reconstruction of migration history; and 6) reconstruction of temperature history. Use of trace elements as natural tags (applications 4 and 5) has already proven successful in answering questions previously considered to be nearly intractable.

Recent studies have cast doubt on the general use of otolith strontium:calcium ratios for reconstructing temperature histories. Oxygen isotope ratios in otoliths reflect temperature much more accurately, but at present are limited by available technology to the estimation of average temperature histories. The WG wishes to be kept closely informed of developments in this field, since many of them will be directly applicable to the study of recruitment processes.

II.6 Review of the Relationship Between Size, Growth and Mortality in Early Life Stages

The WG was presented with an extensive review prepared by one of the members (E. Houde, USA), summarising the principles of size based survival theory which have been expounded at length in previous reports of the RPWG. Earlier discussion of this topic had been almost entirely theoretical but on this occasion the utility of the approach was illustrated by reference to field and laboratory data on the vital rates of early life stages of fish. The review stimulated considerable discussion and is a theme which the WG will continue exploring.

II.7 Review of the Report from the Study Group on Spatial and Temporal Integration (ICES CM 1993/L:9)

The SGSTI report (CM 1993/L:9) was subjected to detailed dissection during the meeting, with the objective of distilling out the aspects which were uniquely relevant to studies of recruitment processes. In addition, the WG provided comment on each of the main conclusions from the SG. Overall, the WG was able to accept most of the conclusions from the SG, but recognised some areas where it had not been possible for the SG to supply the advice sought. The SG was recognised as having made valuable progress in a difficult area of investigation. The WG went on to recommend a further SG meeting, focused on a case study, with the objective of providing detailed advice on the characterisation of spatial and temporal variability in abundance and mortality estimation, and survey design related to these topics. The recommendation raises serious issues concerning the constitution and funding of ICES Study Groups, bearing in mind the need to draft in individuals having the necessary specialised skills to perform such complex tasks.

III. CONCLUSIONS

Concerning the cod checklist:

- The task is almost completed.
- The checklist is an important contribution and a good basis for comparative studies.

Concerning modelling of larval growth:

- Modelling of somatic growth in larvae still requires attention.
- The only practical way of reconstructing the growth history of an individual is from otolith microstructure.
- Otolith growth is hypothesised to be a function of body size, otolith size, temperature, age and food consumption.
- Explicit modelling of otolith growth is not yet possible.

Concerning the analysis of larval fish otolith data:

- There are species specific differences in the relationship between otolith size and fish length.
- There is a significant temperature effect on otolith growth rate.
- There is a significant effect of otolith size on otolith growth rate.
- The data collected for analysis during the WG meeting were insufficient to test the proposed model.

Concerning the otolith elemental analysis:

- New technology is poised to make a significant contribution in this area.
- Whole otolith elemental composition analysis is already a useful technique for stock discrimination.
- The strontium:calcium ratio in otoliths does not have a simple relationship with temperature.

Concerning the relationship between size, growth and mortality:

- Temperature and body size are the two variables which have been found to be most closely related to growth and mortality during early life.
- Mortality rates of eggs and yolk-sac larvae are generally higher than in feeding stages.
- Mortality and growth are linked in a single process which may be expressed as the ratio Z/G .
- The ratio Z/G declines with larval development.
- Cohort biomass declines during the early life stages, only increasing after the ratio Z/G becomes <1 .

Concerning the Study Group report:

- The Study Group has made a significant progress and provided important advice on the analysis of sub-grid scale variability.
- The minimum significant spatial and temporal scales vary with the size of the organisms being considered.
- The identification of first and second order processes with respect to recruitment is an important task.

IV. RECOMMENDATIONS

As a result of its meeting in Lysekil, Sweden, the Recruitment processes Working Group recommends that:

1. ICES should approve the appointment of P. Pepin (Canada) as chairman of Working Group effective from the end of the ICES Statutory Meeting in 1994.
2. ICES should reconvene the Study Group on Spatial and Temporal Integration under the chairmanship of W.S.C. Gurney (UK) with the term of reference:

"To provide advice on approaches to analysing data and optimising the temporal and spatial design of surveys for determining spatial patterns in stage-specific abundances and mortalities of fish eggs and larvae",

but with the following considerations:

- i) The Study Group should work by correspondence in the first instance to draw up detailed specifications, budget requirements and evaluation criteria for the assigned task, making use of case study data as necessary, designed to meet the above term of reference.
 - ii) ICES should support the Study Group by providing funds (eg by eliciting contributions from member organisations) or assisting in the provision of the funds (eg by acting as negotiator with international funding agencies) necessary to conduct the specified task. Funding will be a prerequisite to achieving significant technical progress.
 - iii) Monitoring, evaluation, and reporting of the outcome of the task to the Biological Oceanography Committee, should be carried out by the Study Group.
 - iv) ICES Delegates responsible for nominating members of the Study Group should be requested to ensure that the membership includes the following skills: geostatistics, conventional statistics, hydrodynamic modelling, numerical methods, larval fish biology and ichthyoplankton surveys.
3. Depending on the outcome of preliminary work on the relationships between otolith weight and linear measures of otolith size to be carried out by a subgroup of the RPWG (S. Campana, Canada; T. Linkowski, Poland; H. Mosegaard, Sweden), a Workshop on the Relationship Between Otolith Growth and Body Growth in Fish Larvae should be held in Canada in 1996 immediately preceding the next meeting of the RPWG, and be organised by S. Campana, Canada. The subgroup will report

back to the RPWG chairman before the 1994 ICES Statutory Meeting, and include terms of reference for the proposed Workshop in their report.

4. The next meeting of the RPWG should be in June 1996 in Halifax, Canada, to include the following draft terms of reference which may be reviewed and added to during 1995:
 - a) Review the outcome of the Workshop on the Relationship Between Otolith Growth and Body Growth in Fish Larvae, and identify further steps to be taken.
 - b) Review progress with the Study Group on Spatial and Temporal Integration.
 - c) Review progress in the application of size based theory to recruitment problems and in particular to:
 - develop explicit relationships between mortality and body size in early life and carry out sensitivity analyses to determine which parameters are most sensitive to changes in size specific survival.
 - to examine stage specific rates and their variability, and determine how variability changes with stage development.
 - to determine whether there are critical stages or sizes where variability in rates changes significantly.
 - d) Review progress in the application of otolith elemental analysis to recruitment problems.

V. REPORTS ON INDIVIDUAL DISCUSSION TOPICS

V.1 Progress with the Cod Checklist

The final draft of the cod and haddock checklist was presented and circulated for comments. The document was considered to be a useful summary of the current information. Alterations requested by participants in the meeting were of a minor nature. Some concern was expressed about the uses to which the data might be put and it was recommended that a suitable caution should be included in the Introduction. The checklist was considered to be especially useful in indicating areas where large gaps in knowledge remain.

Although one of the original intentions of the checklist was to highlight gaps in knowledge on various stocks, it was clear that there already exists sufficient understanding to form the basis for a comparative study between stocks. The remit for carrying forward such studies on cod stocks rests with the Working Group on Cod and Climate Change. The primary aim of such an exercise should be to identify those factors controlling the decline or success of stocks and answer questions such as:

- Why has the Arcto-Norwegian stock appeared to be more stable than others?
- Does fishing have a negative effect on the reproductive characteristics of the adult stock?

- What are the relative contributions of fishing and environmental factors in determining stock changes?

The conclusions from such a programme could then be used to target more detailed studies into, for example the role of fishing in determining the genetic composition of stocks and the consequences of changes in genetic composition for growth and survival of fish.

A number of options for continuation of the checklist exercise were discussed, in particular:

- Updating the checklist and bibliography after a period of approximately five years.
- Carrying out a similar exercise on other species.
- Carrying out a similar exercise in relation to specific life history stages or mechanisms.

The WG has no plans to implement any of these options within the next two years.

V.2 Models of Larval Fish Growth

Models of growth are required for a variety of investigative purposes, for example:

- To estimate distributions of size at age by interpolation between observations
- To infer size selective mechanisms with time.
- To infer changes in biomass of fish in response to changes in prey or temperature.

Empirical observations of relationships between otolith size and fish size indicate that the microstructure of the otolith potentially records the growth trajectory of individual fish thereby providing a means of testing growth models, provided that the relationship between otolith growth and body growth can be determined.

The process of modelling growth in fish larvae should proceed along three lines:

1. Models of somatic growth
2. Models of otolith growth
3. Models linking fish and otolith growth

In each case, development should proceed from the simplest form towards more complex as understanding of the processes involved improves, with the proviso that complexity in models should be supported by data of equivalent detail. Models of somatic and otolith growth should proceed simultaneously with the linkage between them being established whenever possible. The WG was presented with several examples of the different approaches to modelling growth. First, a review of the principles of basic models describing mean growth in a population (Appendix 1). Second, a description of a model of compensatory growth in fish and an attempt to modify this to apply to fish larvae (Appendix 2), and finally an empirical model linking somatic and otolith growth in larvae (Appendix 3).

Since the only practical means of investigating variability in growth rates in the field is through analysis of otolith microstructure, the WG decided that the most profitable approach in the short term was to focus on the linkage between somatic growth and

otolith growth. Several studies suggest that the relationship between otolith size and body size is complicated, with a significant contribution from the age of the fish. A simple model of the relationship regards daily increment deposition as being the result of two processes - a conservative process and a dynamic process. The conservative component operates all the time, even when a fish is not increasing in weight. The dynamic component is a function of the instantaneous rate of metabolism and is therefore responsive to feeding rate and temperature. Such a model will have limitations, and cannot be expected to function at the individual level in instances where larvae are losing weight during starvation. Also, it is not known how the phenomenon of compensatory growth in body weight is reflected in otolith microstructure.

As a first step in establishing the functional form of the conservative part of the deposition process, a power function relationship was proposed between otolith growth rate, body size, otolith size, age and temperature:

$$dO/dt = a.S^b.O^c.T^d.A^e$$

where O = otolith weight, S = somatic weight, T = temperature and A = age.

In reality, there are few instances where both otolith and somatic weights have been measured on the same individuals. A practical starting point is therefore to substitute otolith radius for otolith weight and body length for somatic weight. An important prerequisite to progress in this area is to establish the form of the relationship between linear measures of otolith size and weight, and the consistency of the parameters of such relationships across life stages and species.

The data on otolith microstructure assembled by WG participants were analysed during the meeting to determine whether there was any cross-species support for the above functional model of otolith growth. The results are described below.

V.3 Analysis of Fish Larvae Otolith Data

In preparation for preliminary tests of candidate growth models, working group participants arrived at the meeting with data from a variety of larval fish species and populations. Ten data sets on cod, herring, sandeel, sprat and smelt were analysed during the meeting. The measurements included fish size, otolith size, daily age, daily increment width, temperature and prey availability, although not all measurements were present in every set. The full extent and composition of the data are described in Table 1. Since the terms of reference of the working group included the development of candidate growth models, it was difficult to predict the variables and data contrast that would eventually be required. Hence, the size and completeness of the individual data sets varied considerably. Nevertheless, there were sufficient data to initiate the process of model testing, beginning with falsification of the simplest models, and proceeding to the more complex.

Preliminary analysis of the data on cod, herring, sprat and sandeel length-at-age and otolith radius-at-age, aggregated across sample collections, highlighted the diversity of growth rates across species and cruises (Figs 1 and 2). Variability in the relationship between fish length and otolith radius among cruises for a given species was much less marked, albeit still significant (Fig. 3). The form of the relationship within a species appeared to be consistent among data sources. However, there were substantial

differences among species, with cod and sprat characterised by a linear or power relationship, and herring characterised by an exponential relationship (Fig. 4, Table 2). It was not immediately obvious why the form of the fish-otolith relationship should differ so much between species. However, it was noted that such differences among species and life history stages are commonly observed.

The model assuming a common relationship between fish length and otolith radius for a given species was rejected by testing for differences induced by temperature. Analyses of covariance by species, using fish length and otolith radius as the dependent and independent variable respectively, and temperature as a categorical factor (by two degree intervals) resulted in a significant temperature effect for both herring ($n = 527$, $p = 0.002$) and sprat ($n = 795$, $p = 0.001$). The effect of temperature was non-significant for cod, but the analysis for that species was confounded by the presence of various data artifacts and could not be considered reliable.

Given the significant temperature effect on relative otolith growth, the next stage of the analysis considered the rate of otolith growth as a function of otolith size and temperature. The width of the third most recently-deposited daily increment (Ring3) was used as an index of the derivative of otolith growth. Ln-ln regressions of Ring3 on otolith radius were significant in all species and collections considered, those being herring (two independent cruises), sandeel, and smelt (Fig. 5). In addition, the slope of the regression differed significantly both among species and between cruises within species. Regressions of Ring3 on temperature resulted in a significant positive slope for smelt, but was not significant in the case of sandeel (Fig. 6). The corresponding regression for sandeel, smelt and herring combined was also significantly positive (Fig. 6), although the justification for pooling the species in this way was questioned.

The final stage of model testing used a stepwise multiple regression model to test for the effects of ln otolith size, ln fish size, ln temperature and age on recent otolith growth (ln Ring3). Unfortunately, the temperature contrast in the data sets which included all the necessary measurements was rather small ($<2^{\circ}\text{C}$). Therefore, the model could not be tested satisfactorily. Nevertheless, the model was fitted to the Shetland-Orkney herring data, despite the presence of only a 1.9 degree temperature range. Both otolith radius (adjusted to the radius at Ring3) and age entered the model significantly; temperature and body size did not. The working group members were not satisfied that the same results would have been observed in the presence of a greater range of temperatures. As an exercise, the estimated model parameters were used to stochastically model otolith radius as a function of body length. Otolith increments were integrated over the age of the herring larvae in a randomised model using the standard error of the regression parameters and assuming normal error distributions. A log-linear relationship between body length and age was used as a growth model for the larvae. As a test of the model performance the integrated value of final otolith size was plotted against calculated larval length and compared to the observed otolith radius and length (Fig. 7).

The integrated values exhibited a very wide scatter including some impossible outliers in comparison to the narrow spread of observed values. The positive coefficient of otolith size was the major source of variation in the integrated calculation of otolith size at fish size using the prediction model. This result indicates that caution should be exercised when using otolith size as a regressor in otolith growth models due to the auto correlative effect.

Conclusions of Analysis and Recommendations for Further Action

The time available for exploratory analysis during the meeting was too short, much of it having been used in assembling the submitted data into a common format. The main conclusion of the analyses carried out during the meeting was that the data available at the meeting were insufficient to test the proposed model of growth. Nevertheless, there was agreement that the exercise had been worthwhile and that evaluation of the functional form of the relationship between otolith growth and body growth was worth pursuing. One means of achieving this would be to hold a Workshop dedicated to this task alone.

Reservations were expressed about the value of holding a workshop without having first carried out some further preliminary assessments. In particular, it was noted that the basic model links otolith weight to body weight, whereas almost all data sets refer only to otolith radius or area and body length. Reliable functional relationships for deriving otolith weight from linear measures of otolith size are required. A sub-group of the main WG comprising S. Campana (Canada), T. Linkowski (Poland) and H. Mosegaard (Sweden) agreed to carry out the following preliminary tasks:

- a) Assemble data on otolith weights, area and radius measurements from a variety of species.
- b) Evaluate the consistency of the relationships linking otolith weight, area and radius.
- c) If the relationships appear consistent, prepare terms of reference for a Workshop on the Relationship Between Otolith Growth and Body Growth in Fish Larvae which would be held in Canada in 1996, including a nomination for an organiser, and a workplan for assembling the necessary data.
- d) Report back to the RPWG chairman before the 1994 ICES Statutory Meeting in order that the results and any recommendations can be reported to the Biological Oceanography Committee along with the main report of the RPWG.

V.4 State of the Art in Otolith Elemental Analysis

Otoliths are well known for the formation of the annual and daily growth increments used in their age determination. However it is their elemental and isotopic composition which has attracted attention as a potential means to track, identify and reconstruct the temperature history of individual fish. This potential is based on two characteristics of the otolith: a) otoliths grow throughout the life of the fish, and unlike bone, are metabolically inert; once deposited, otolith material is unlikely to be resorbed or altered (Campana and Neilson, 1985); and b) the calcium carbonate and trace elements that make up 90% of the otolith appear to be mainly derived from the water (Simkiss, 1974). Accordingly, the elemental and isotopic composition of the otolith reflects that of the water in which the fish lives, although not necessarily in a simplistic fashion (Kalish, 1989; Fowler *et al.*, 1995). As a result, several applications have emerged which take advantage of these properties:

1. Chemical marking/mass marking
2. Radiochemical dating
3. Pollution index
4. Stock identification

5. Reconstruction of migration history
6. Reconstruction of temperature history

Good progress has been made towards each of the above objectives, with the primary limitations having been largely technical. These limitations stem from the relative purity of the otolith as a calcium carbonate body. Aside from the organic component of the otolith (which makes up 1-10% of the weight) (Degens *et al.*, 1969), the most abundant trace element is Sr, with a mean concentration of 0.2% by weight. An additional 20 - 30 trace elements have been detected, but with concentrations at or below the parts-per-million level (Campana and Gagne, 1994). Detection and quantification of these elements has proved to be challenging, although the situation is now improving. Nevertheless, the technical limitations to the elemental and isotopic assays of otoliths has led to two different approaches for their analysis, each with different underlying assumptions, and targeted towards different sets of hypotheses:

- a) Dissolution and assay of the whole otolith, resulting in a mean elemental concentration integrated over the entire lifetime of the fish. In general, this approach provides the greatest accuracy, precision and sensitivity, and is often the only viable assay approach for some elements and isotopes. Needless to say, this approach does not take advantage of the age-structured information present in the otolith.
- b) Use of a beam probe to assay short sequences of growth increments. In principle, this approach will allow a more detailed reconstruction of the life history, perhaps even to the daily level. In practice, the potential is limited due to the problems of targeting the appropriate sequence of increments, depth integration of the probe into underlying growth increments, and most importantly, less sensitive and less accurate quantification. At present, the most sensitive beam probes have spatial resolutions on the order of 15-30 μm .

Reconstruction of Temperature Histories Using Elemental Analysis

Sr:Ca ratios have a long history of use in corals, where there is a well-accepted empirical relationship between the ratio and temperature at the time of incorporation. Radtke and Targett (1984) introduced their use to otolith workers, where they have gained some acceptance by those interested in reconstructing temperature history. At least part of this acceptance was due to the selection of elements: Ca and Sr make up the two most abundant elements in the inorganic matrix (concentrations of 38% and 0.2%, respectively), and are among the few elements which can be quantified with the commonly-available electron microprobe. Early applications to the otolith were encouraging, and appeared to indicate a reasonable relationship with temperature. However, more recent studies, including several laboratory experiments, have cast doubt on the generality of this relationship (Kalish, 1989; Sadovy and Severin, 1992, 1994). There is now increasing acceptance of the fact that the apparent inverse relationship of Sr:Ca with temperature is largely correlative, not causal. Indeed, there is growing evidence that the Sr:Ca relationship is more a function of otolith crystallisation rate than anything else, and that previous reports of a relationship with temperature were due to the effect of temperature on otolith growth. Such a mechanism would go some ways towards explaining the physiological disruption of the Sr:Ca relationship (Kalish, 1989), as well as the apparent absence of a relationship through a portion of the temperature range (Townsend *et al.*, 1992). These findings are somewhat unfortunate, since the electron microprobe used for Sr:Ca assays has a spatial resolution of 3 μm , equivalent to the width of daily growth

increments in some fish. However, there are now enough concerns with the use of Sr:Ca ratios that its use for reconstructing temperature histories cannot be recommended.

While it is not commonly known, there are also other trace elements in the otolith which vary as a function of temperature. Among these are Fe (Gauldie *et al.*, 1980) and a host of trace elements detectable only with inductively-coupled plasma mass spectroscopy (ICPMS) (Campana and Gagne, 1994; Fowler *et al.*, 1995). It is not yet known if these elements are influenced by factors other than temperature, although such appears likely. One potential advantage of these other elements is that they may escape the physiological regulation which can affect the uptake of Sr.

Isotopic Analysis

At present, the ratio of the $^{18}\text{O}:^{16}\text{O}$ isotopes is the most rigorously based of the available assay techniques for reconstructing temperature history (Devereux, 1967). A strong correlation between the oxygen isotope ratios and temperature has been observed in all biogenic carbonates, not just otoliths, and has been validated experimentally in both the former and the latter (Kalish, 1991). In principle therefore, this is the way to go. However, two limitations exist:

- a) The $^{18}\text{O}:^{16}\text{O}$ ratio is strongly influenced by salinity. Therefore, if the salinity at the time of deposition is not known, the temperature cannot be accurately estimated. There is now work in progress to determine if salinity history can be reconstructed based on trace element composition.
- b) Current sample requirements are on the order of 1 mg. Sample requirements 10 years ago were on the order of 1 g, so considerable progress has been made. Nevertheless, 1 mg samples are beyond the capabilities of any existing beam probe. In the interim, an otolith coring device has been developed to allow otolith material to be sampled from discrete annuli (S. Campana, Canada). This device is too coarse to consider using at the daily increment level. However, those interested in analysing otoliths from post-larval fish could conceivably derive average temperature histories from assays of whole otoliths. The use of a laser-based technique for determining $^{18}\text{O}:^{16}\text{O}$ ratios has recently been explored, but failed to achieve the necessary precision levels. However given the rapid advances now being made in instrumentation, it is probable that a laser-based sampling device for $^{18}\text{O}:^{16}\text{O}$ assays will be developed in the not-too-distant future.

V.5 Review of the Relationship Between Size, Growth and Mortality in Early Life Stages

Ecosystems can be viewed as size-structured entities. As such, dynamic properties of the system and of individuals within it are responsive to the trophic structure that determines growth, mortality and production. In size-structured systems, declines in biomass and numbers should be predictable as a function of size. Predation is thought to be the principal cause of loss and prey are hypothesised to be a fixed proportion of predator size. A brief chronology of the evolution of this concept with respect to fish recruitment research is given in Appendix 4.

The mortality of fish larvae, and more generally the recruitment process, can be envisaged as size-structured processes. In this context, mortality rates are a function of size, are

closely tied to growth processes, and are linked to the overall production constraints of an ecosystem.

An important point is that mortality and growth are linked in a single process. Body size and temperature are the two factors that have been demonstrated to be most important in predicting mortality of fish early life stages. Because growth and mortality are affected equally by temperature, the cumulative mortality (mortality x stage duration) is not expected to differ in relation to temperature. Body size potentially becomes the major controller of mortality rate. This hypothesis provides a context within which the mortality process and recruitment variability can be studied.

Mortality rates of fish eggs and larvae are high and variable. Small changes in daily rates, mortality or growth, integrated over a stage duration on the order of 30 d, can cause the order of magnitude variabilities in recruitment that are frequently observed. It is remarkable that fluctuations are not greater, given the high fecundities and high, variable rates that have been estimated. This observation suggests that density-dependent regulation plays an important role early in life.

Egg and yolk-sac larvae mortalities generally are higher than those of feeding-stage larvae. Mortality rates are declining during the larval stage, and growth rates are increasing. Consequently, the ratio of mortality to growth (Z/G) is declining and the biomass of a cohort must decline initially, often to less than 25% of its biomass at hatching, before cohort biomass begins to increase. It is important to note that eggs and yolk-sac larvae do not grow, but they suffer high mortality. Conceptualisations of the mortality, growth, and biomass-generating process in early life indicate the important points (Figs 8 and 9).

The ratio of Z/G , referred to as the physiological or stage-specific mortality rate, is an important parameter in examining the recruitment process of fish. Its magnitude, its variability between stages, and its trend with age or size, can be used to determine which early life stages contribute most to variability in potential recruitment. There may be critical lengths or weights where variability in Z/G can have important consequences in the production of a cohort. Variability in the sizes or ages where $Z/G = 1.0$, or where the ratio is minimal, also are indicators of potential cohort success or failure.

Mortality (or survivorship) can be expressed in either age-specific or size (= stage)-specific terms. The age-specific mortality coefficient, Z_d , can be converted to a size-specific rate by dividing by growth rate. The simple expression for stage-specific survivorship, S , is:

$$S = (W_t/W_0) \exp(-Z_d/G)$$

where W is weight, t and 0 indicate end- and beginning-stage weights, and G is the weight-specific growth rate.

In size-specific theory, the decline in mortality of organisms (Z_d), expressed as an instantaneous daily rate, is related to weight by the proposed relationship:

$$Z_d = W^{-0.25} \times 5.26 \times 10^{-3} \quad (\text{Appendix 5})$$

There is evidence that mortality of fish eggs and larvae is considerably higher than the rates-at-weight predicted from the proposed relationship. Intense predation has been

hypothesised as the probable reason, perhaps enhanced by increased vulnerability, a consequence of patchy distributions. Interspecific and inter-regional comparisons of the relationship between mortality rate and weight would be important to undertake to determine if there are predictable weight-specific relationships between mortality and weight, as well as to determine how mortality varies in relation to size.

There is evidence that Z_d and G are positively correlated when examined across taxa, and it is hypothesised that they are inversely correlated within a taxon in a given year (ie high G associated with low Z_d and vice versa). Both Z_d and G are positively and predictably related to temperature. The ratio Z_d/G is independent of temperature because both mortality and growth increase with temperature at the same rate. Consequently, the cumulative, stage-specific mortality is predicted to be independent of temperature.

If density-dependent mortality is important during early life stages, it will be sensitive to sizes and to the Z_d/G ratio. For example, species with a large difference in size-at-stages (W_t/W_0) and a high Z_d/G ratio in the stage will have relatively high potential to be regulated through density dependent growth or mortality in that stage.

Conclusions on the General Concepts of Size Based Theory

From the review presentation given above, the following general concepts emerged and were discussed by the WG. It was pointed out that exceptions may be observed from these generalisations in specific cases.

1. Stage-specific mortality rates are declining during early life. Though widely accepted, few direct observations are available to test this hypothesis. Explicit relationships have still to be established.
2. Highest mortality rates are suffered during the egg and yolk-sac larval stage. Comparing these two stages, mortality may be equally high in the yolk-sac larval stage, whereas it may be more variable during egg development.
3. The causes of differences in egg size among species and stocks were discussed. Recent model results suggest that fish produce relatively large eggs in very uniform environments as well as in very heterogeneous environments, whereas eggs tend to be smaller in moderately patchy environments. This may be related to the initial feeding conditions for the larvae, but also to mortality pressure, as egg size is in general inversely related to the number of eggs produced.
4. Eggs and pre-feeding yolk-sac larvae do not show any positive growth, but rather experience a loss of weight. The consequence is that cohort biomass declines sometimes by >75% during these stages.
5. After the start of active food intake, specific growth rates are proposed to first increase during larval development before a generally decreasing trend with age can be observed.
6. The ratio of specific mortality to specific growth rates (Z/G) is proposed to decline initially during the larval stage. Among taxa, Z is generally positively related to G , but within species Z and G may be inversely related.
7. Cohort biomass declines fast during initial stages, increasing only after the ratio of Z/G becomes <1.0. Thus, a high proportion of a cohort's biomass is lost before the larvae start feeding.
8. If growth efficiency does not change during the larval stage, consumption by a cohort and its energy demand declines during initial stages, increasing only after Z/G becomes <1.0.

9. Cohort abundance may potentially be regulated during any stage in early development. There does not appear to be any one critical stage.
10. The population of survivors from a season's production may develop from a rather restricted part or a tail of the spawning distribution. This has been observed frequently and appears to be important for consideration in survey activity. On a long time average, it is to be expected on the basis of natural selection that the centre of the spawning period should produce the highest number of survivors. However it is not sufficient to concentrate on this period alone.
11. High variability in growth rate may lead to increased probability of survival. This hypothesis is based on modelling results under simplified predator situations and might not hold in a complex predator field.
12. Average prey sizes appear to be predictable for a given predator. However it has been questioned whether there is a constant relationship between prey size and predator size. Prey availability will play an important role.

Recommendations for Future Work on Size Based Theory

1. Explicit relationships between early life mortality rates and body size should be developed.
2. Variability in stage specific rates should be examined.
3. An effort should be made to determine whether there are critical lengths, sizes or stages where vital rates change significantly.
4. Sensitivity analyses are needed to determine which parameters are most sensitive to change with respect to the overall probability of survival.

V.6 Review of the Report from the Study Group on Spatial and Temporal Integration (ICES CM 1993/L:9)

At the request of the RPWG, the Study Group met from 14-18 June 1993, at the University of Strathclyde, Glasgow, Scotland. The SG was provided with four terms of reference:

1. To consider methods of statistically characterising the temporal and spatial variability in populations of larval fish and their predators.
2. To consider and report on the feasibility of integrating temporally and spatially variable abundance and vital rates over population time and space scales.
3. To consider how sub-grid-scale temporal and spatial variability in abundance and rates may be represented at the grid scale in marine ecosystem models.
4. To consider methods of determining the most appropriate temporal and spatial grid resolution for models of fish recruitment.

The terms of reference were directed particularly at recruitment processes and larval fish ecology, but the SG report has broad relevance to modelling and sampling marine ecosystems. The report focuses on grid and sub-grid scale problems and recommends approaches for modelling systems that are sparsely sampled in space and time. Advice and recommendations are summarised in nine conclusions:

1. Larval fish distributions observed at currently practicable resolutions cannot be satisfactorily characterised by presently available statistical techniques.
2. No universal prescription exists for integrating either abundances or vital over diverse space, time or trophic scales.

3. To be effective, models must be targeted at specific questions and tied closely to available data.
4. The optimal choice of model scales is largely determined by the question being asked, the processes being described, and the resolution of the available input data.
5. A suitable choice of scale is one at which sub-grid-scale processes assume second order importance.
6. Theoretical work is needed to develop improved techniques for caricaturing the dynamics of sub-grid-scale processes.
7. Where model input at a fine scale must be derived from data at a coarser scale, the interpolation scheme used should be based on a knowledge of the statistical structure of, and/or the mechanisms generating, the model-scale variability.
8. Model studies should be used to help define optimal sampling schemes at both grid and sub-grid resolutions.
9. Model testing is a process of falsification.

The Study Group concluded that no universal prescription exists for integrating either abundances or vital rates of marine planktonic organisms over space, time and trophic scales. Determining the appropriate scale to model or sample a system is critical. Caricaturing of sub-grid-scale processes was one possible solution suggested by the Study Group. Development of models at different scales, including "stacked models" and detailed submodels also were recommended to describe systems with multiple trophic levels. Decisions on the scale and complexity of models should be based upon the particular questions that are asked.

The problem of disparity of scales across life stages in recruitment research was emphasised. The Study Group concluded that modelling of both numbers and weights is essential in such research. Alone, neither abundance nor biomass measures will be sufficient.

In some cases, modelling based upon coarse-scale observations and data may be satisfactory to achieve goals, even when sub-grid-scale effects are clearly important. Low spatial (or temporal) definition may be acceptable in situations where high biological resolution of a particular process takes precedence.

Modelling transport and physics at meso and larger scales was described as mechanistic and achievable by the Study Group. Generally, the resolution of physical processes in models is 50 km in ocean systems, 5 km in shelf systems and 0.5 km in coastal regions. The constraints imposed by fine and micro scale processes (eg turbulence) will limit the ability to model biological processes.

Decisions regarding scales of resolution sometimes must be based upon whether a process is known to cause "first-order" effects or whether its effects are "second-order." For a first-order factor the modelling (and sampling) scale should be fine enough to describe the variability within prescribed limits that can be statistically defined. Operationally, making such decisions is problematic. For some biological processes of concern in recruitment research, eg diseases, genetics, parasites, it remains uncertain if they should be regarded as first or second-order factors.

RPWG Comments on Study Group Conclusions

The RPWG generally accepted the conclusions of the Study Group. The report contains good, but general, advice and recommendations. More importantly, it points out the deficiencies and constraints that limit our ability to model recruitment. Each conclusion was critically reviewed by the RPWG.

1. The RPWG agreed that characterising and resolving larval fish or egg distributions was a significant and important problem that limited our ability to understand recruitment variability. There was no consensus on the part of the RPWG that a lack of appropriate statistical methods to characterise distributions was the source of the problem but the RPWG did not contradict the conclusion of the Study Group.
2. The RPWG agreed with the Study Group's conclusion that no universal prescription exists to integrate abundances or vital rate data over diverse space, time or trophic scales.
3. The RPWG agreed in general with the conclusion. Models should be targeted at specific questions and usually should be tied closely to available data. But, it was noted that exploratory models may be based on hypothetical examples, simulations, sensitivity analyses, etc, in which the models are not tied to specific data.
4. The RPWG accepted this conclusion.
5. The RPWG agreed with the conclusion, recognising that it may not always be possible to achieve the objective. In recruitment research, it is not always obvious what processes should be considered first or second order in potential importance. Consequently, selecting an appropriate scale to include first order, but not necessarily to include second order processes will require difficult decisions. One way to determine whether a process might be of the first or second order is to undertake a simulation model or sensitivity analysis using available or hypothetical data.
6. The RPWG agreed in general that caricatures can be effective to characterise and include sub-grid-scale processes in recruitment models. The Study Group was not explicit in describing what it meant by theoretical work to improve the caricaturing process. It was suggested that methods of dealing with this problem may have been developed in engineering sciences.
7. The RPWG accepted this conclusion. Further elaboration would be valuable because interpolation with respect to both biological and physical data from coarse to finer scales often could be of first order importance in affecting recruitment itself or the variability in factors that affect it.
8. The RPWG agreed with the conclusion.
9. The RPWG agreed that falsification (rather than validation) of models was proper scientific method. But, this approach might not always be appropriate in the case of certain theoretical or hypothetical models. And, within satisfactory limits of tolerance after appropriate testing, a model eventually can be accepted as satisfactory considering the purposes for which it was intended.

Recommendation for Further Study Group Activity

A major objective and need of recruitment research is to accurately and precisely estimate stage-specific abundances of ichthyoplankton, including egg, yolk-sac larva and postlarval stages. A further objective is to obtain stage-specific mortality rates from abundance information, and to describe the spatial patterns of mortality as they relate to the stage-

specific distributions and abundances. Bottlenecks in this process are a) lack of methods for estimating spatial patterns in rates from abundance data, and b) lack of guidance on optimal survey designs, particularly regarding the relevant temporal and spatial scales that must be sampled.

The RPWG recommends that the Study Group on Spatial and Temporal Integration be reconvened to provide advice on appropriate methods and sampling designs for obtaining accurate and precise estimates of abundance that can lead to spatially resolved stage-specific mortality rates. It is proposed that existing data sets on ichthyoplankton and corresponding flow field data from hydrodynamic models be provided to the Study Group as case study material. The RPWG requests that the Study Group examine these data, undertake analyses, and reach conclusions regarding methods for estimating spatially resolved stage specific abundances and mortality rates and provide advice on appropriate temporal and spatial scales, as well as other factors, that must be considered in designing future surveys.

The proposed term of reference for the Study Group is:

"To provide advice on approaches to analysing data and optimising the temporal and spatial design of surveys for determining spatial patterns in stage-specific abundances and mortalities of fish eggs and larvae."

Candidate data sets on herring larvae from areas of the North Sea together with output from hydrodynamic models are available and are believed to be suitable for the proposed exercise.

Practical Implications of Approving the Proposed Study Group

The RPWG suspects that despite the apparent simplicity of the terms of reference, achieving significant progress with the task is beyond the scope of a simple committee meeting in the normal style of ICES Study Groups. The task will certainly require significant effort on data analysis and modelling outside the confines of any meeting of SG members. Furthermore, given the lack of effective control that Study Group chairmen have over the composition of the Groups, there is no guarantee that the constitution of a meeting of nominated members would include the skills necessary to carry out the work and provide a state of the art comment on the issue. The WG considered that the following skills would be required in the Study Group: geostatistics, conventional statistics, hydrodynamic modelling, numerical methods, larval fish biology and ichthyoplankton surveys.

The RPWG considers that the complexity of the task dictates a different approach to that of the usual ICES Study Group activity. Actually carrying out the data analysis and modelling work will require significant resources to be directed towards a competent individual or group of individuals. The RPWG asks whether ICES can play a role in obtaining funding to enable its Study Groups to meet their objectives. This role is seen as being especially relevant with regard to Study Groups since, in general, they have a short life and targeted terms of reference. It is suggested that ICES could institute a scheme of bursaries, perhaps funded by contributions from member organisations. Alternatively, ICES could endorse proposals emanating from its Study Groups by acting as negotiator with international funding agencies.

The RPWG suggests that the Study Group on Spatial and Temporal Integration should operate by correspondence in the first instance, to draw up the detailed specifications, budget requirements and evaluation criteria for the assigned task. Further progress beyond this point would require funding. Should ICES be prepared to proceed along the lines indicated above in providing or enabling the provision of funds, then the Study Group should monitor and evaluate the progress of the task on behalf of ICES, and provide a final report covering the overall terms of reference to the Biological Oceanography Committee.

Taking into account the above constraints on the success of the proposed Study Group, The RPWG recommends that:

- i) The Study Group should work by correspondence in the first instance to draw up detailed specifications, budget requirements and evaluation criteria for the assigned task, making use of case study data as necessary, designed to meet the term of reference
- ii) ICES should support the Study Group by providing the funds (eg by eliciting contributions from member organisations) or assisting in the provision of the funds (eg by acting as negotiator with international funding agencies) necessary to conduct the specified task.
- iii) Monitoring, evaluation, and reporting of the outcome of the task to the Biological Oceanography Committee, should be carried out by the Study Group.
- iv) ICES Delegates responsible for nominating members of the Study Group should be requested to ensure that the membership includes the following skills: geostatistics, conventional statistics, hydrodynamic modelling, numerical methods, larval fish biology and ichthyoplankton surveys.

VI. LITERATURE CITED

- Campana, S.E. and Gagne, J.A. 1994. Cod stock discrimination using ICPMS elemental assays of otoliths. In: *Fish Otolith Research and Application*, D.H. Secor, J.M. Dean and S.E. Campana (eds). University of South Carolina Press. Columbia, SC. (In press.
- Campana, S.E. and Neilson, J.D. 1985. Microstructure of fish otoliths. *Can. J. Fish. Aquat. Sci.*, **42**, 1014-1032.
- Degens, E.T., Deuser, W.G. and Haedrichm R.L. 1969. Molecular structure and composition of fish otoliths. *Mar. Biol.*, **2**, 105-113.
- Devereux, I. 1967. Temperature measurements from oxygen isotope ratios of fish otoliths. *Science*, **155**, 1684-1685.
- Fowler, A.J., Campana, S.E., Thorrold, S.R. and Jones, C.M. 1995. Experimental assessment of the influence of temperature and salinity on otolith elemental composition using solution-based ICPMS. *Can. J. Fish. Aquat. Sci.* In press.
- Gauldie, R.W., Graynorth, E.J. and Illingworth, J. 1980. The relationship of the iron content of some fish otoliths to temperature. *Comp. Biochem. Physiol.*, **66A**, 19-24.

- Kalish, J.M. 1989. Otolith microchemistry: validation of the effects of physiology, age and environment on otolith composition. *J. Exp. Mar. Biol. Ecol.*, **132**, 151-178.
- Kalish, J.M. 1991. Oxygen and carbon stable isotopes in the otoliths of wild and laboratory-reared Australian salmon (*Arripis trutta*). *Mar. Biol.*, **110**, 37-47.
- Radtke, R.L. and Targett, T.E. 1984. Rhythmic structural and chemical patterns in otoliths of the Antarctic fish *Notothenia larseni*: their application to age determination. *Polar Biol.*, **3**, 203-210.
- Sadovy, Y. and Severin, K.P. 1992. Trace elements in biogenic aragonite: correlation of body growth rate and strontium levels in the otoliths of the white grunt, *Haemulon plumieri* (Pisces: Haemulidae). *Bull. Mar. Sci.*, **50**, 237-257.
- Sadovy, Y. and Severin, K.P. 1994. Elemental patterns in red hind (*Epinephelus guttatus*) otoliths from Bermuda and Puerto Rico reflect growth rate, not temperature. *Can. J. Fish. Aquat. Sci.*, **51**, 133-141.
- Simkiss, K. 1974. Calcium metabolism of fish in relation to ageing. In: *The Ageing of Fish*, T.B. Bagenal (ed), p1-12. Unwin Brothers Ltd. Surrey, England.
- Townsend, D.W., Radtke, R.L., Corwin, S. and Libby, D.A. 1992. Strontium:calcium ratios in juvenile Atlantic herring *Clupea harengus* otoliths as a function of water temperature. *J. Exp. Mar. Biol. Ecol.*, **160**, 131-140.

APPENDIX 1

The Basis of Simple Growth Models

J E Beyer

Danish Institute for Fisheries and Marine Research, Denmark

1. Variables

Measurable state variables constitute a prerequisite for modelling. However, the options are not that many since very few characteristics of growth can be measured directly using traditional methods. In fact, in most cases, it is only body weight (W) and length (L) at age (annual rings) that at best are available. Additional independent data on growth increments are important for fitting and testing purposes but such data are difficult to obtain in sufficient numbers under the same environmental conditions using eg mark-recapture techniques.

	Weight volume	Length radius	Increment	Time intervals
Fish	W	L	$dL ?$	$dt ?$
Otolith	Ω	R	$dR = r$	1 day

Measurements of the daily ring depositions on the otolith offer potentially a new data source for the development of the individually-based growth models (IBGMs) that are needed for obtaining correct descriptions of the effect of size-specific vital rates on the dynamics of fish populations. The development of otolith growth models without direct reference to fish size could prove important in itself. It will among other things put focus on which characteristics of otolith size and shape that are needed (eg areas and/or volume), help in standardising overall otolith growth performance and give some guidance to the discovery of likely measurement-errors. The main task is clearly one of developing models of how the control of somatic growth (eg temperature, oxygen uptake and food consumption) is reflected in the daily otolith deposition.

2. Modelling

It is important to distinguish between modelling growth and modelling the development in mean size-at-age in a population. Growth refers to the individual fish whereas the observed (sampled) mean size-at-age also has been influenced by possible effects of size-selective mortality (both fishing and natural), migration etc. Due to the nature of the data available, this distinction is usually not made in traditional fishery science and the term "growth" is often used to designate "increase in mean size-at-age". This is also reflected by the fact that body weight W is replaced (incorrectly) by mean weight \bar{W} in the various (non-linear) growth equations. Such manipulations are clearly acceptable if the purpose is simply one of fitting a curve to a set of mean size-at-age data. If the purpose on the other hand is to gain quantitative insight into growth then the replacement of individual weight by mean weight implies that all the members of the cohort are assumed to be of the same size. However, in stock assessment a year-class always comprises fish that are of very different size due to eg the variability in individual growth and the effect of an extended spawning season. In the Baltic for example, a herring of 20 cm length can

be anything from one year to 10 years of age. The variability in size-at-age should constitute a major motivator for beginning to make the transfer of IBGMs to the population level. There are no short-cuts to modelling mean population dynamics before the effects of the size-specific rates on the underlying distributions at the individual level have been evaluated.

Truly IBGMs are of a stochastic nature. However, simple deterministic modelling may be used to gain insight into the effects of variability in size-at-age on the mean population characteristics. A cohort can be represented by a distribution of size-at-age in which fish of length L for example could be considered to grow with certain von Bertalanffy Growth Equation (VBGE) parameters. This does not mean that any one fish in reality is expected to grow according to a smooth VBGE but it is a way of quantifying the basis for investigating eg the spread in size-at-age which often is observed as a cohort becomes older. It all adds up to the necessity of being precise in formulating the objective of modelling in each case in order to avoid misuse of models. With this in mind, realising the danger in giving general statements about modelling, some very simple growth models that have gained wide application are briefly mentioned below. Modelling is recognised as being distinct from pure curve fitting using more or less arbitrary mathematical formulations although good analytical or mechanistic growth models provide satisfactory approximations to a growth curve and their validity can be tested by data other than size-at-age. Thus their importance as analytical models of growth is determined by the information contained in the parameters. But such models may, of course, also be used exclusively to create empirical growth curves. The requirement here is that they must be easy to handle and widely applicable to sets of data on size-at-age. The parameters do not have to have any particular significance. The simple VBGE:

$$L = L_{\infty} (1 - \exp(-K(t-t_0))) \quad (1)$$

and the Gompertz equation

$$\ln L = (\ln L_{\infty})(1 - \exp(-K(t-t_1))) \quad (2)$$

are well-known examples. VBGE covers the case when an inflexion on the length curve is not suggested by the data. The Gompertz equation deals with the situation when an inflexion is apparent. When growth accelerates until it is suddenly discontinued (eg death after first spawning) or when growth is consider only for a specific life-history stage (eg larval fish) the Parker-Larkin equation usually provide a good description:

$$W^p = W_0^p + C_t \quad (3)$$

The advantage of the analytical models shows up only when the parameter estimates are to be used for further reasoning eg when forecasting the effects upon the growth curve of changing the temperature or the rate of feeding. One has to be extremely careful in concluding anything regarding the validity of a growth formulation based on the result of fitting only. In general, a very wide class of models and equations can all provide very nice fits to available data on size-at-age. Data needs to be extremely accurate and cover a large part of the growth curve before we are able to reject growth models on this basis. The parameters in fitting analytical based models to empirical curves, however, often take on values incompatible with their physiological interpretation. Parameter estimation from data other than size-at-age therefore often leads to rejection of the growth hypothesis underlying the model investigated. Different lines of reasoning according to different

assumptions may also lead to identical growth curves (eg the logistic curve), the only difference being the parameter interpretation.

3. Rationale

A simple starting point is needed for developing models of otolith growth. We could with reason choose any of the classical models mentioned above. The common metabolic model (also known as the general VBGE) ie:

$$dW/dt = HW^m - kW^n \quad (4)$$

leads to the standard VBGE with $m = 2/3$ and $n = 1$ and, hence, to Eq 1 in case of isometric growth. In this formulation the first part (HW^m) can be regarded as an anabolic term whilst the second part (kW^n) represents a catabolic term. The parameters m and n contain information on oxygen consumption as a function of eg body weight and feeding level and of growth rate as a function of food consumption. Cell differentiation models have different implications, namely on the reproductive ability of cells as a function of cell differentiation, but leads to the Gompertz equation (which in the form of Eq 2 fits growth curves of fishes as well as any other). The so-called negative-feed-back model postulates certain molecular reactions promoting and inhibiting growth and has implications on the size of individual organs in the body and on wound healing. In its simple form it leads to the logistic curve - a symmetrical sigmoid - but can be elaborated (by incorporating of the cell differentiation model) to a complicated expression giving a sigmoid without restrictions on the inflection point. However, we do not even know at this stage what curvature that mean otolith-size-at-age (ring counts) may reveal. Clearly inflexion points or the possible pattern of consecutive convex R-shapes (ie where dr/dt is positive) and concave shapes (ie where dr/dt is negative) constitute important information (if valid). Empirical based investigations along these lines can easily be carried out.

Using the metabolic model as the starting point, Eq 4 and its underlying reasoning in terms of somatic growth permits one to express the rate of change in otolith deposition, $d\Omega/dt$, as a function of eg oxygen uptake, temperature (both of which represent prevailing hypotheses put forward in the current literature) and food consumption or feeding level. This yields an additive rate model (because decomposition does of course not take place in otoliths) for $d\Omega/dt$ the first term representing rate of metabolism and the second being a function of eg the feeding level. Following current practice, one could investigate whether simple allometric relationships link for example otolith volume to the present radial measurements (eg $\Omega = \alpha R^b$) in the same way as body weight is linked to body length ($W = aL^b$). This would permits one to translate a rate equation for eg volume, directly into a similar equation for otolith radial increment, $r = dR/dt$. Although the level of detail dealt with here undoubtedly will be needed in most applications, a simpler approach should be tried first as the starting point for modelling otolith growth for larval fish. Otolith-increments in larval fish apparently reveal a much quicker response of somatic growth to changes in the conditions than for bigger fish (which appear to show conservative rate changes in otolith increments following starvation periods). When the power m in the anabolic term is smaller than the catabolic power n (which is true in almost every case) then at small weights the catabolic term becomes small compared to the anabolic and it appears sufficient to consider the whole process in terms of one component, ie

$$dW/dt = QW^n \quad (5)$$

This model forms the basis of general allometric relationships in ecosystem particle size analysis ($n = ca\ 0.75$). It does appear to describe most data available on mean size-at-age on larval fish up to and beyond metamorphosis and is also used as the basis for some of the most recent models of gastric evacuation in fishes. A model of this type dates back to the beginning of the century but in fishery context it was first considered by Parker and Larkin in 1959. It implies Eq 3 for W-at-age (with $p = (1-n)$ and $C = (1-n)Q$ if n is different from 1). The growth curve in weight will show a concave form being linear for $n = 0$ and moving through the exponential curvature when $n = 1$. With an allometric weight-length relationship Eq 5 transforms into:

$$dL/dt = Q_1 L^u \quad (6)$$

where $W = aL^b$; $Q_1 = Q.a^{(n-1)/b}$; $u = (1-b(1-n))$

It follows that the rate of growth is constant if $b = 4$ in case of $n = 0.75$. Length-at-age will increase in a concave relationship (as will W-at-age) if the power b is smaller than 4. The relationship changes to a convex one when b exceeds $1/(1-n) = ca\ 4$. These relationships are given by Eq 3 with W , p and C replaced by L , $b(1-n)$ and $(1-n)a^{(n-1)Q}$ respectively.

4. Otoliths

The first question is whether the simple allometric models of body growth are also useful as a basis for modelling otolith growth, ie:

$$d\Omega/dt = P\Omega^\tau ; \Omega = \alpha R^\beta$$

where Ω denotes the weight (or volume) of the otolith at time t , that is $d\Omega/dt$ basically gives the rate of protein deposition on the otolith. This relation leads to the same type of allometric relationship for the rate of increase in radial increment and we obtain similarly to Eq 6 that:

$$r = dR/dt = P_1 R^\delta ; P_1 = P\alpha^{(\tau-1)/\beta} ; \delta = 1-\beta(1-\tau)$$

where r is the daily increment width simply referred to as the daily ring. Ring counts are usually made from the centre of the otolith. In this application we are interested in the outer (terminal) ring in order to be able to expand the simple model in Eq 8 in a stepwise procedure with factors governing terminal measurements of eg body-size and the environment such as temperature, feeding and turbulence conditions. These factors are called external factors (since at this stage we are not yet concerned with the existence of possible causal relationships). However, in practice the outer ring cannot be measured accurately. Instead we have to use the second or third terminal ring (r_2 or r_3). The final selection of a reference ring is a trade off between accuracy in ring width measurement and accuracy in the simultaneous external factors which can only be measured at the time of capture (ie relevant for the terminal ring). One may clearly repair for changes in the external factors by hindcasting from terminal conditions to conditions relevant at the time of ring deposition, but such refinements are not really appropriate at this stage of modelling. Let $r_{(i)}$ denote the reference ring. Eq 8 then reads on a logarithmic form,

$$\ln(r_{(i)}) = \text{intercept} + \delta \cdot \ln(R_{(i)}) ; R_{(i)} = R - (r_{(1)} + r_{(2)} + \dots + r_{(i)}) \quad (9)$$

The examination of the effect of each external factor will extend this linear analysis with a new explanatory variable (unless the external factor is highly correlated with R (such as L) in which case nothing "new" will happen).

Using the simple model (Eq 8 or Eq 9) at the individual level as suggested here is likely to result in a considerable residual variation. The allometric model is usually applied directly to the population level by replacing W by \bar{W} in Eq 5 as stated above. Similar investigations using measurements of mean otolith sizes are also of interest. However, a basic question concerns the species or stage specific relationship between weight (or volume), areas and radial measurements of the otolith. One must know to what degree the allometric weight-radius relationships etc are valid before an operational way of measuring the otolith can be defined and standardised.

APPENDIX 2

A Model of Compensatory Growth in Fish and its Application to Fish Larvae

M Heath
Marine Laboratory Aberdeen, UK

Acknowledgement: The work described here was mainly carried out by Dr N. Broekhuizen, Prof W.S.C. Gurney, Dr A. Jones, and Dr A. Bryant of the Universities of Strathclyde, Paisley and Aberdeen respectively, and their contribution is gratefully acknowledged. The work formed part of EC grant MAST 0021C(TT).

Fish living in the natural environment are continually exposed to prey concentrations which fluctuate on a variety of time scales from seasonal to instantaneous. The growth process in an individual fish must integrate this signal in some way. Laboratory experiments on fish held in alternating starvation and refeeding regimes have shown that this integration is not straightforward since individuals exhibit a phenomenon known as compensatory growth.

If a well fed fish is starved for some period of time the growth rate ceases and individuals rapidly lose weight. After a period of time the rate of weight loss decreases. When fish are then refeed there is a short lag, after which a period of very rapid growth in weight may occur, during which the individuals may show growth rates in excess of those in control fish, and such that the starved fish may catch up and even exceed the weight of control individuals (Fig. A2.1). The dynamics of growth in length are rather different, since individuals cannot become shorter during starvation periods. This is the phenomenon known as compensatory growth.

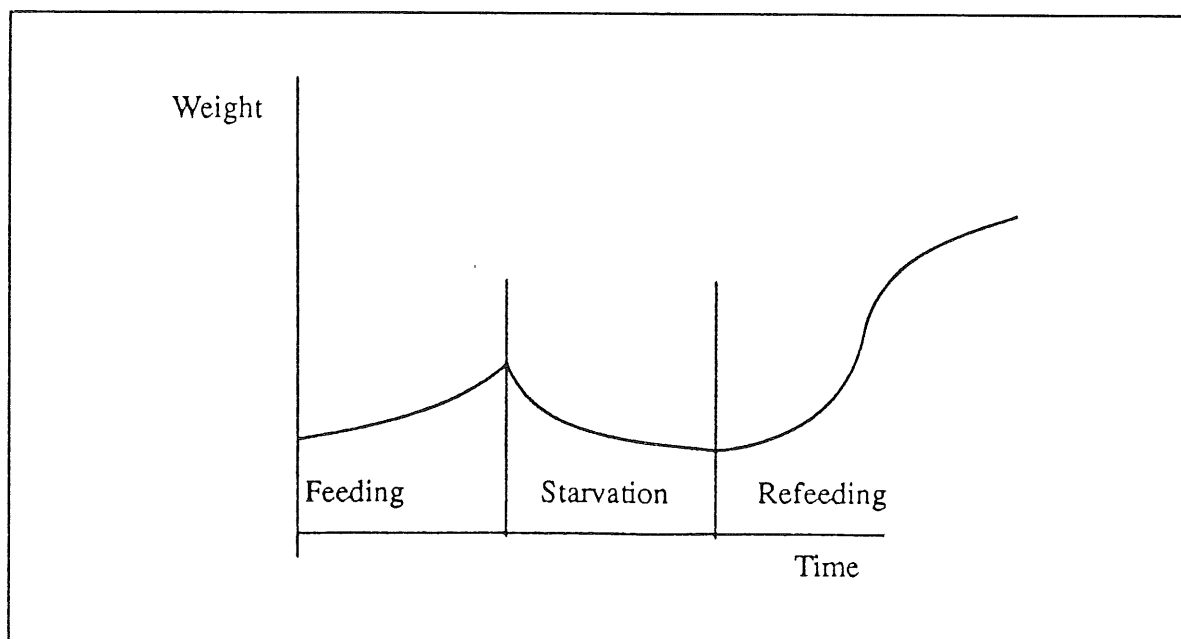

Figure A2.1 Schematic representation of the changes in body weight of a fish subjected to a period of starvation.

As part of an attempt to represent fish population numbers and biomass in an ecosystem model, Broekhuizen *et al.* (in press) developed a model of compensatory growth for adult and juvenile fish. The model was initially parameterised and tested against laboratory data on rainbow trout and Arctic char, and later adjusted to represent herring in the North Sea (Bryant *et al.*, in press). The focus on compensatory growth was not inspired by an interest in this process *per se*, but by the idea that the phenomenon revealed the underlying factors controlling growth under fluctuating prey conditions.

First of all, it was realised that simple von Bertalanffy type model in which growth rate is determined solely by the instantaneous prey concentration and body size cannot account for the compensatory growth phenomenon. Some form of monitoring of physiological state is required to achieve the observed dynamics. Based on past experience of this type of problem, Broekhuizen *et al.* developed a model in which the body weight is split into a structural and reserve component. Structural weight (S) is an analogue of length, and cannot be remobilised to meet living costs during periods of starvation. Structural weight can be considered to represent skeletal and nervous tissue for example. Reserve weight (R) can be broken down to meet costs (M) during adverse conditions and can be taken to represent musculature and lipid reserves. Experiments indicate that individual fish can lose up to 60% of their healthy body weight before dying, and hence that the healthy ratio of reserve weight to structural weight (referred to as the reserve ratio) is approximately 1.5. Specific costs (M) scale according to total weight, whilst maximum uptake rate was assumed to scale with structural weight. Assimilated material (A) is directed towards building up structure and/or reserve according to a function of the reserve ratio:

$$dR/dt = A - M - dS/dt$$

$$dS/dt = C(p)[A - M]^+$$

$$p = R/S$$

$$[x]^+ = \max[x, 0]$$

$C(p)$ = proportion of excess A allocated to building S

The model contained a number of parameters. Eight parameters could reasonably be established from the literature. A further seven were adjusted to provide simultaneous optimal fits to four different data sets whilst remaining within an envelope set by literature data. Only two parameters were completely free fit, requiring tuning to each test data set separately. Nevertheless the values of the free fit parameters remained within the range indicated by the literature.

Broekhuizen *et al.* fitted the model to laboratory data on rainbow trout, and then tested against completely independent data on the same species. The results indicated that the model provided an excellent qualitative explanation of the changes in both length and weight of the fish during cyclical feed-starve regimes (Figs A2.2 and A2.3).

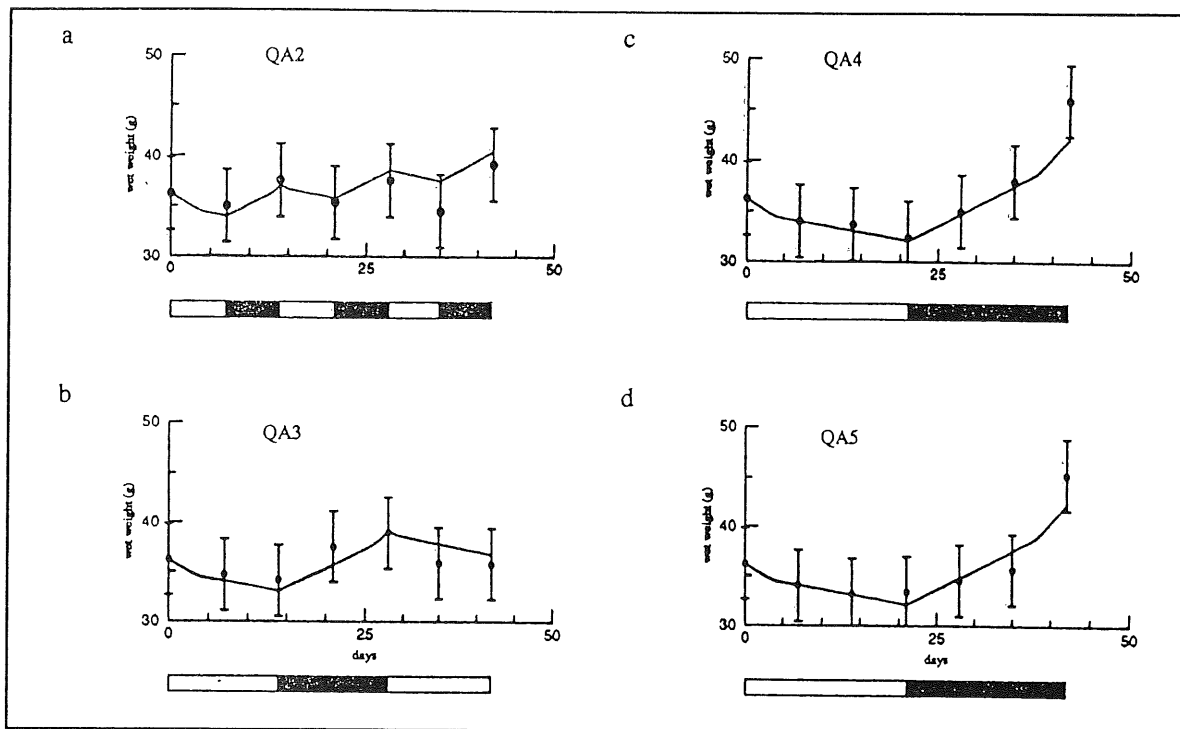

Figure A2.2 Observed and predicted patterns of weight change in trout. Solid bars below each graph indicate food supplied, empty bars indicate no food supplied. These data were used by Broekhuizen *et al.* to parameterise the model.

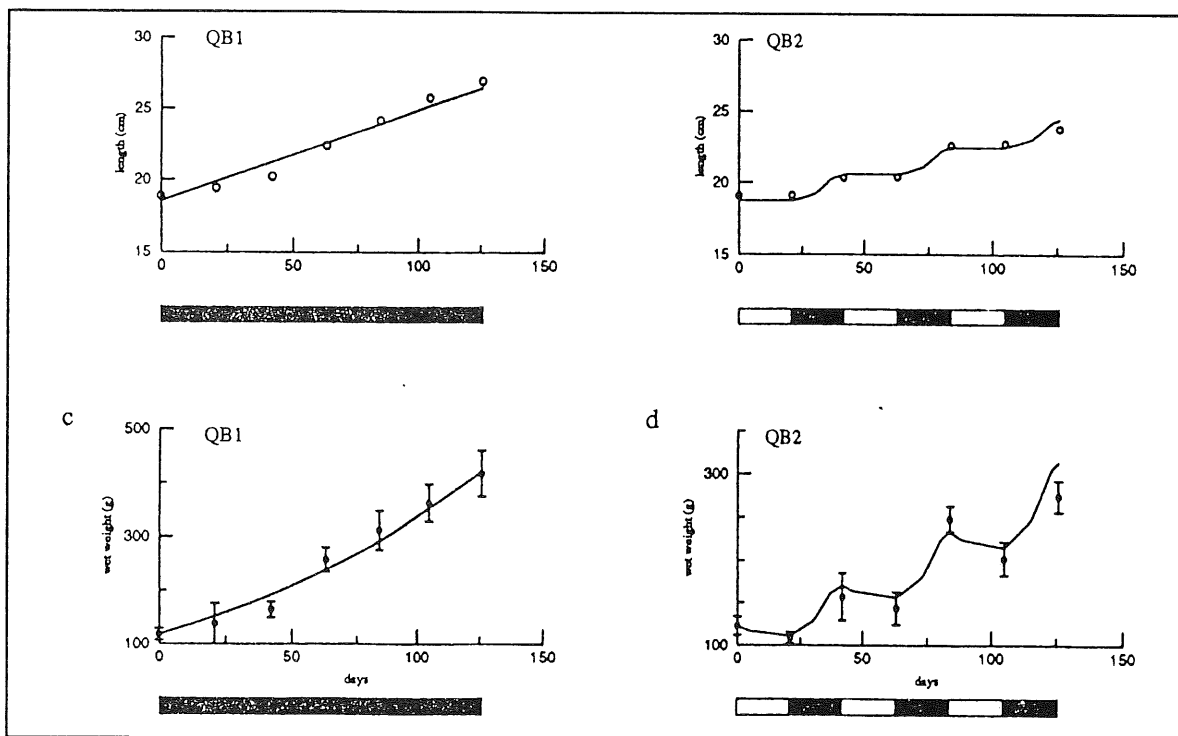

Figure A2.3 Observed and predicted patterns of weight change in trout in separate experiments from those illustrated in Figure A2.2. The model was NOT fitted to these data. Solid bars below each graph indicate food supplied, empty bars indicate no food supplied.

In an attempt to establish whether the same basic model could be applied to growth of larval fish in fluctuating prey environments, initial conditions and driving data were set up to simulate a set of experiments on herring larvae described by Houlihan *et al.* (submitted). In these experiments, three groups of larvae were maintained under different rations. Group 1 were treated as controls and fed an increasing ration over time matching the increasing demands of the growing larvae. A second group were transferred to a low ration for four days before joining the controls on the high ration. A third group were kept for eight days on the low ration before reverting to the high ration (Fig. A2.4). The trajectories of mean weight and length in the three groups were indicative of compensatory growth by the group 2 and 3 larvae, and this was supported by simultaneous measurements of protein synthesis and body biochemistry.

The model was run with minimal alteration to the parameter set derived by Bryant *et al.* to describe adult herring. Initial results are shown in Figures A2.5 and A2.6. It must be stressed that these are merely a first look at the performance of the model, with no attempt having been made to review the suitability of the parameter values for larval herring. Very crudely, the modelled trajectories in weight reproduce some of the features of the experiments. However, there are strong indications that the parameters assigned to the living costs of early larvae are completely wrong since the model predicts a loss in weight during the first four days whilst a gain was observed in the experiments. The larvae were in non-feeding yolk-sac state during this period, so it is not surprising that the model as parameterised did not capture this effect. Also, the strength of the compensatory response is over predicted by the model, but the healthy reserve ratio in larvae may be lower than in adult fish. The model clearly fails to reproduce the dynamics of growth in length, suggesting that some aspects of the allometry of assimilation are incorrect.

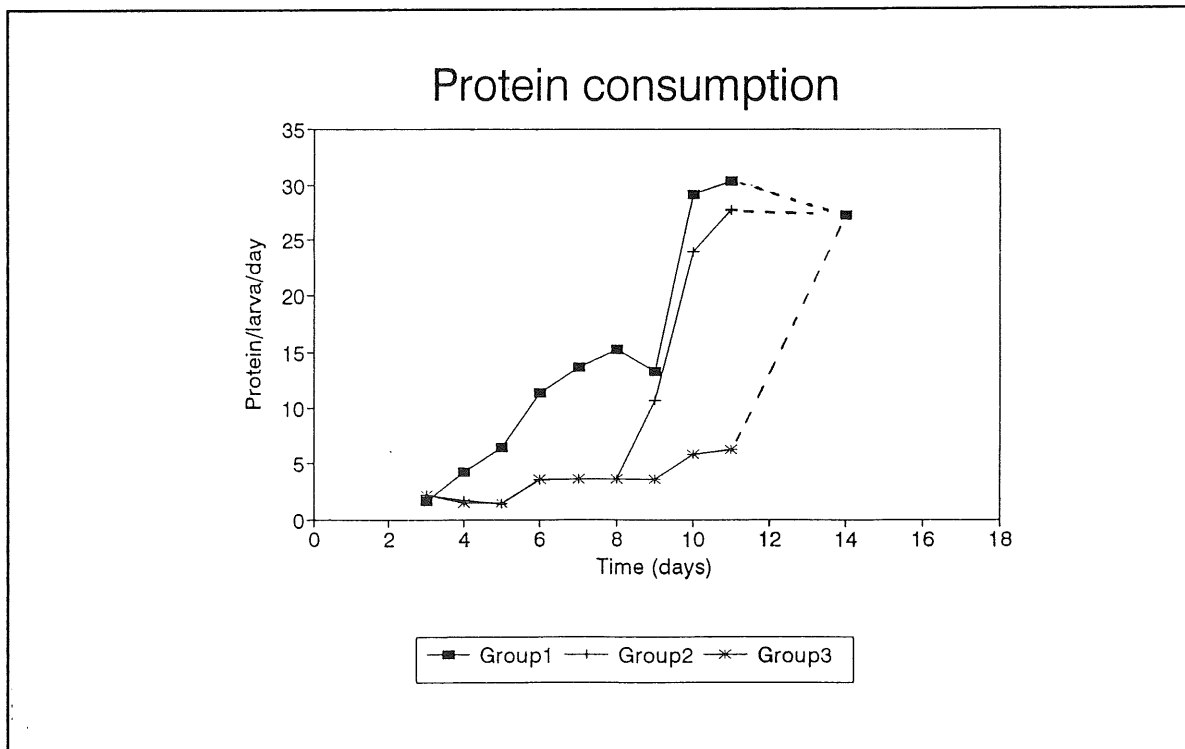

Figure A2.4 Protein consumption rates of three groups of herring larvae during an experiment run for 17 days from hatching.

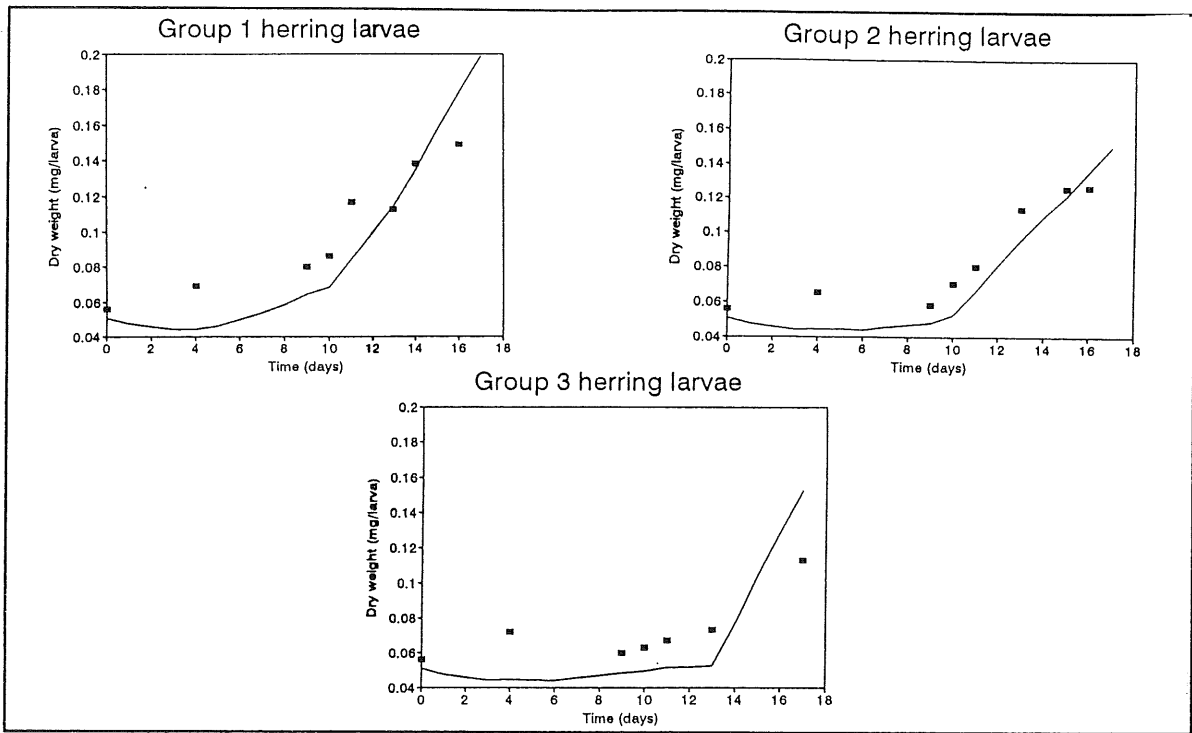

Figure A2.5 Observed (symbols) and modelled (line) changes in dry weight of three groups of herring larvae subjected to different rations.

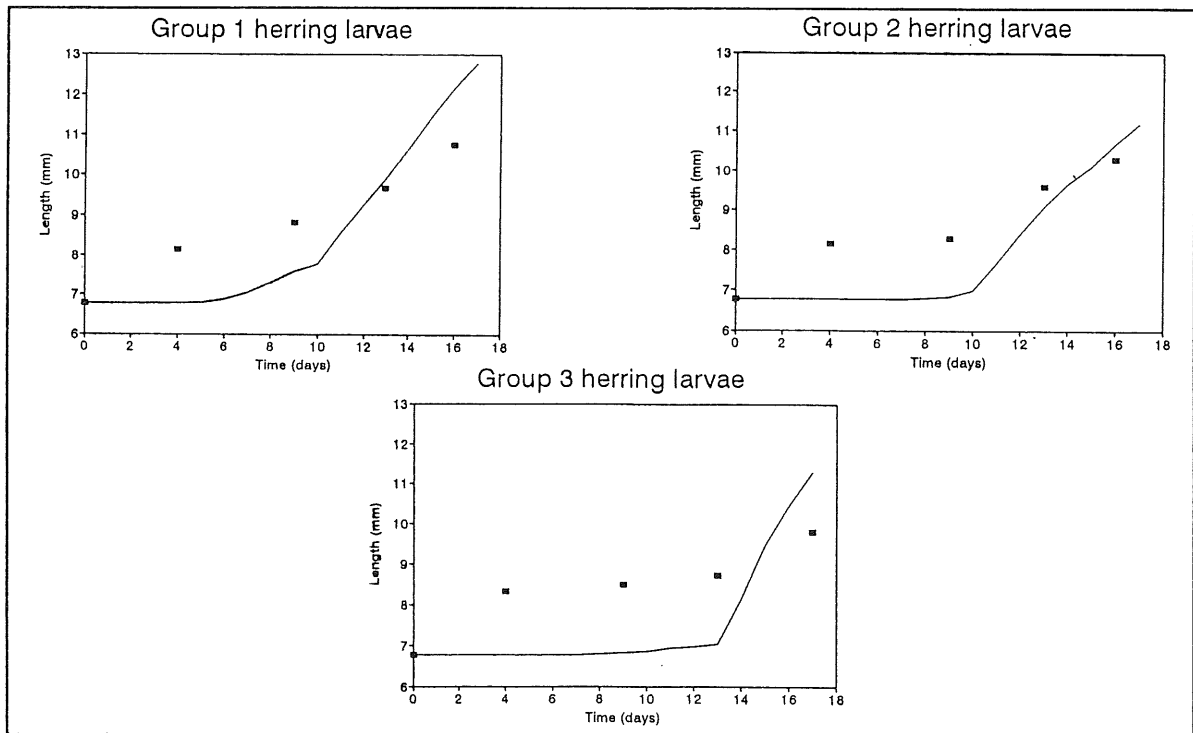

Figure A2.6 Observed (symbols) and modelled (line) changes in length of three groups of herring larvae subjected to different rations.

Despite the flaws outlined above, it seems that the model does have considerable potential to explain the growth trajectories of fish larvae in fluctuating prey environments. More work will be necessary to develop the parameterisation to the extent where the model will be able to give even a qualitatively good fit the data described by Houlihan *et al.* One problem for further development may be the lack of other data suitable for testing the model. The ultimate aim of the application of the model to fish larvae is to simulate the growth of larvae on an ecosystem model in which the prey environment is also simulated by a stage structured zooplankton model with driving data provided from a hydrodynamic model. The intention is to test the entire system against field data on zooplankton, hydrography, meteorology and larval otolith microstructure collected adjacent to a drifting marker buoy. These developments will be reported to future meetings of the RPWG.

References

- Broekhuizen, N., Gurney, W.S.C., Jones, A. and Bryant, A.D. Modelling compensatory growth. *Functional Ecology*. (In press).
- Bryant, A.D., Heath, M.R., Broekhuizen, N., Ollason, J.G., Gurney, W.S.C. and Greenstreet, S.P.R. Modelling predation, growth and population dynamics of fish within a spatially resolved shelf-sea ecosystem model. *Netherlands Journal of Sea Research*. (In press).
- Houlihan, D.F., Pedersen, B.H., Steffensen, J.F. and Brechin, J. Compensatory growth in larval herring; protein synthesis, growth and energetics. *Marine Ecology Progress Series*. (In review).

APPENDIX 3

A Model of Otolith and Larval Fish Growth

H Mosegaard

Institute of Freshwater Research, Drottningholm, Sweden

Introduction

It is generally agreed that otoliths are conservative in their response to changes in fish growth rate. Increments are often formed even during periods of starvation. The increment width is however also influenced by the growth rate of the fish. The aim of this note is to formulate some ideas of otolith growth into a simple model that will reflect the basic properties expected in otoliths of a variety of species and different sizes.

Without reviewing the literature, some general features of otolith and fish growth are suggested.

- Fish larvae and small fry do not cease otolith formation unless under the final lethal phase of starvation.
- A change in somatic growth rate at constant temperature is only slowly reflected in the change of otolith increment width.
- A temperature change is immediately reflected in the width of otolith increments, higher temperatures giving increased otolith growth rates.
- On a longer term basis there is a positive correlation between somatic growth rate and increment width.
- The total amount of material laid down per day on the otoliths of a large fish is greater than the amount deposited in a small fish.
- The somatic and otolith growth rates should be considered on a per weight basis.

Short term changes in the weight of a fish may be viewed as a combination of change in mean cell weight and the total number of cells. The otolith-secretory cells of the saccular tissue may have a less direct coupling to protein turnover rate than eg the cells of the white muscles. It may be important for the fish to keep secretory functions at a conservative level. When food level is high during a prolonged period of time the number of secretory cells will multiply as a function of overall somatic growth rate.

The brain parts of a fish are generally growing conservatively to the major somatic parts, but also the degradation rate of secretory cells is expected to be lower than the degradation rate of the white muscle cells. The secretory activity however may partly be controlled by the overall metabolic level of the fish and as such dynamically influenced by eg protein turnover rate.

The Model

The above considerations lead to a conceptual model where otolith growth rate is a function of both the amount and the specific metabolic state of the existing secretory tissue. The amount of this tissue in turn being a function of recent growth history:

$$dO_w/dt = f(\text{metabolism}) * W_s * T^{[a_1]}$$

where O_w is otolith weight, W_s equals the weight of the secretory tissue and $T^{[a_1]}$ equals temperature raised to a power less than one. In turn the specific growth rate of the secretory tissue may be expressed as a function of body specific growth rate:

$$(dW_s/dt)/W_s = (a_2 * (dW_w/dt)/W_w) - a_3$$

a_2 should generally be less than one to reflect the lower growth rate of the brain parts than the main body. W_w equals the fish body weight and a_3 the degradation rate of the secretory tissue.

The specific metabolic level may be regulated by feed-back control to growth rate, with the lower limit reached after long term starvation and the upper limit found during maximal growth rate.

If metabolism for a start is considered constant over a range of positive growth rate values a simple evaluation of the model may be conducted.

The following parameters are used for modelling larval growth:

$$dW_w/dt = \text{in} - \text{out}$$

$$\text{in} = \text{gscale} * \text{conv} * \text{food} * r_s * W_w^{[(0.693) * \exp(0.14 * T - 0.0015 * T^2)]}$$

$$\text{out} = \text{gscale} * r_A * W_w^{[r_B * \exp(T * r_B)]}$$

$$(dW_s/dt)/W_s = (((dW_w/dt)/W_w) * a_2) - a_3$$

Setting $a_2 = 1$ and $a_3 = 0$ for larval fish, specific growth rate of the brain parts is here equal to somatic growth rate.

$$dO_w/dt = a_4 * W_s * T^{[a_1]}$$

increment width is found using:

$$\text{Radius} = (O_w / \text{SpD} * 3\pi/4)^{(1/3)}$$

and fish total length is assumed to be:

$$TL = (W_w * 100)^{1/4}$$

$$a_1 = 0.77, \text{ conv} = 0.4, r_s = 0.17, r_A = 0.016, r_B = 0.705, \text{ SpD (otolith spec density)} = 2.5$$

The model contains several stochastic elements: food at low levels is assumed regularly distributed between 0.4 and 0.6, and food at high levels regularly distributed between 0.48 and 1.0. gscale is 0.5 with a normally distributed stdev of 0.05 a_4 is 200 with a normally distributed stdev of 40.

Initial values are:

$$TL = 0.9 \text{ cm} \Rightarrow W_w = 0.006561 \text{ g}$$

$$O_w = 20 \text{ ng} \Rightarrow \text{Radius} = 12.407 \text{ } \mu\text{m}$$

Numerical integration was conducted over 2, 10, 18, 26 and 34 days with the specified stochastic variation. In different runs high and low food levels were compared at different temperatures.

Results

At a constant temperature of 10°C the model predicts an increase in larval length with a slightly decreasing slope after 34 days at food levels of 1, 0.8, 0.6 and 0.4; larval lengths were 3.0 cm, 2.4 cm, 1.8 cm and 1.1 cm respectively. The otoliths reached at the same time 84 μm , 64 μm , 45 μm and 27 μm , respectively. The three highest food levels having increasing slopes (increasing increment widths with time from 0.6 to 2.5, 1.7 and 1.0 respectively) whereas the lowest food level showed a decreasing slope (increments decreasing from 0.6 to 0.3). Otolith radius vs fish length were compared at high and low food levels at 10°C. A typical "growth rate effect" emerged where slow growing fish had a larger otolith size at comparable fish size (Fig. A3.1). When growth was compared at 8°C and 12°C no pronounced temperature effect was evident at high food levels (Fig. A3.2), whereas at low food levels larger otoliths were found at 12°C compared to 8°C (Fig. A3.3). A temperature effect at high food levels was found comparing two high temperature regimes of 14°C and 18°C (Fig. A3.4). The model show a generally increasing otolith radius vs fish length at high food levels whereas there the same relationship is decreasing at low food levels. The model seems to simulate some of the otolith growth features of Atlantic herring larvae, even without considering a dynamic metabolic force. A more strict parameterisation is needed as well as a validation on an independent data set.

fig1

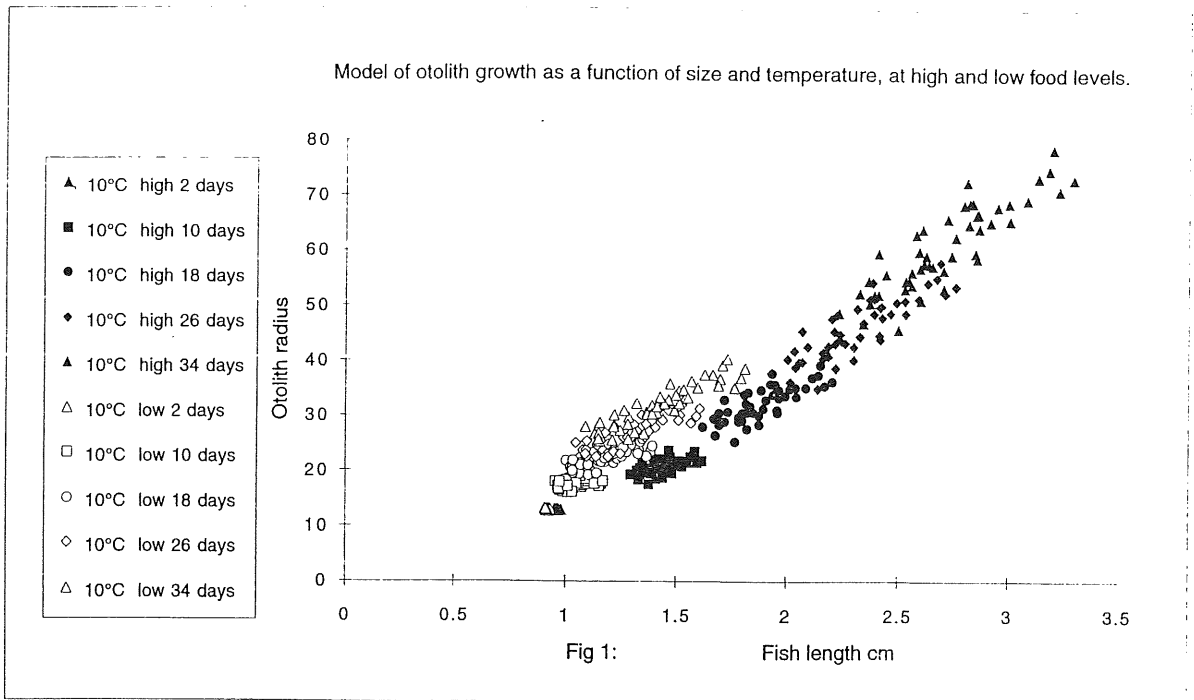

fig2

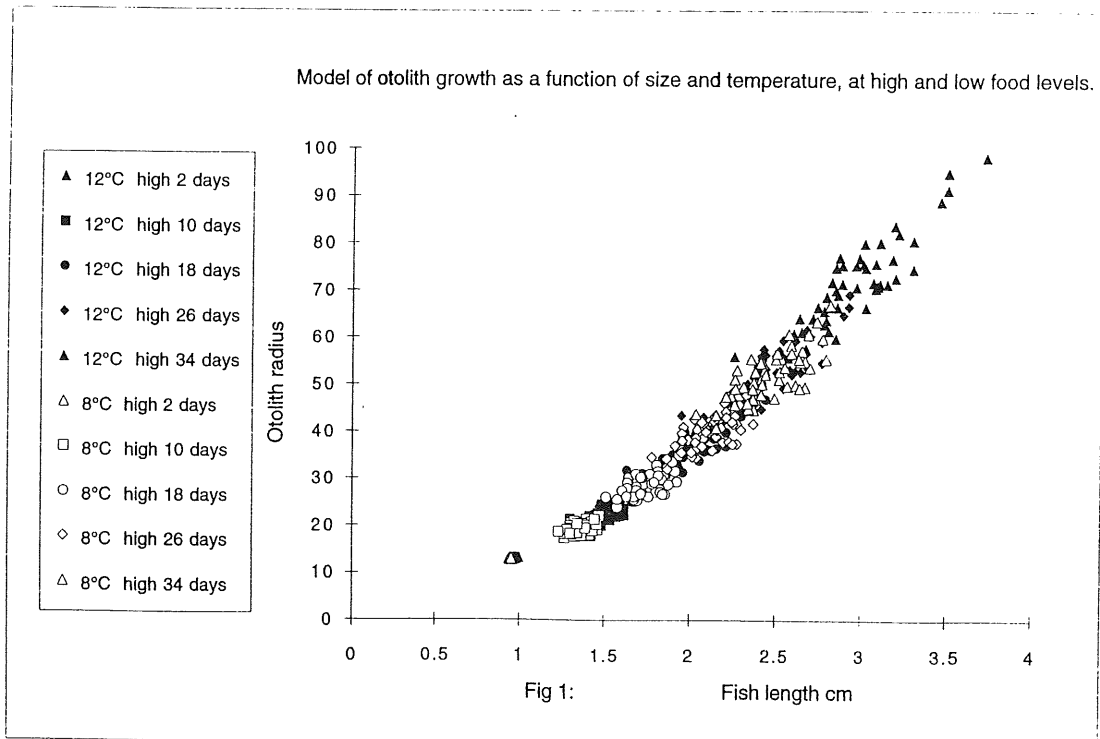

fig3

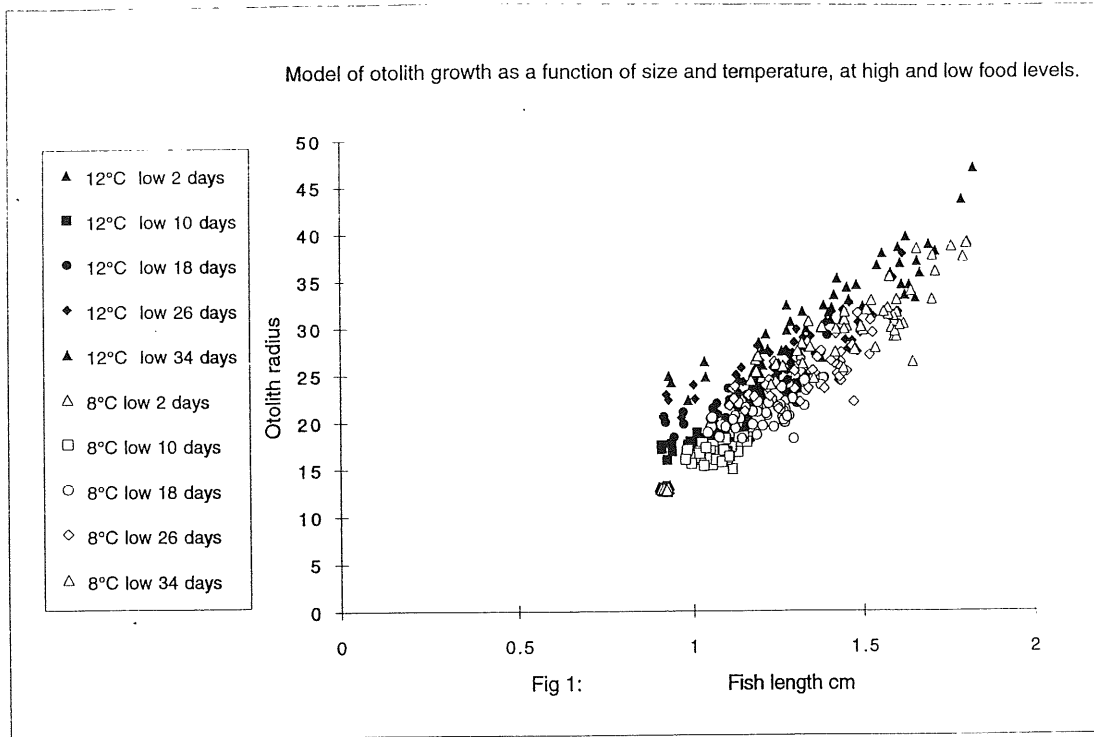
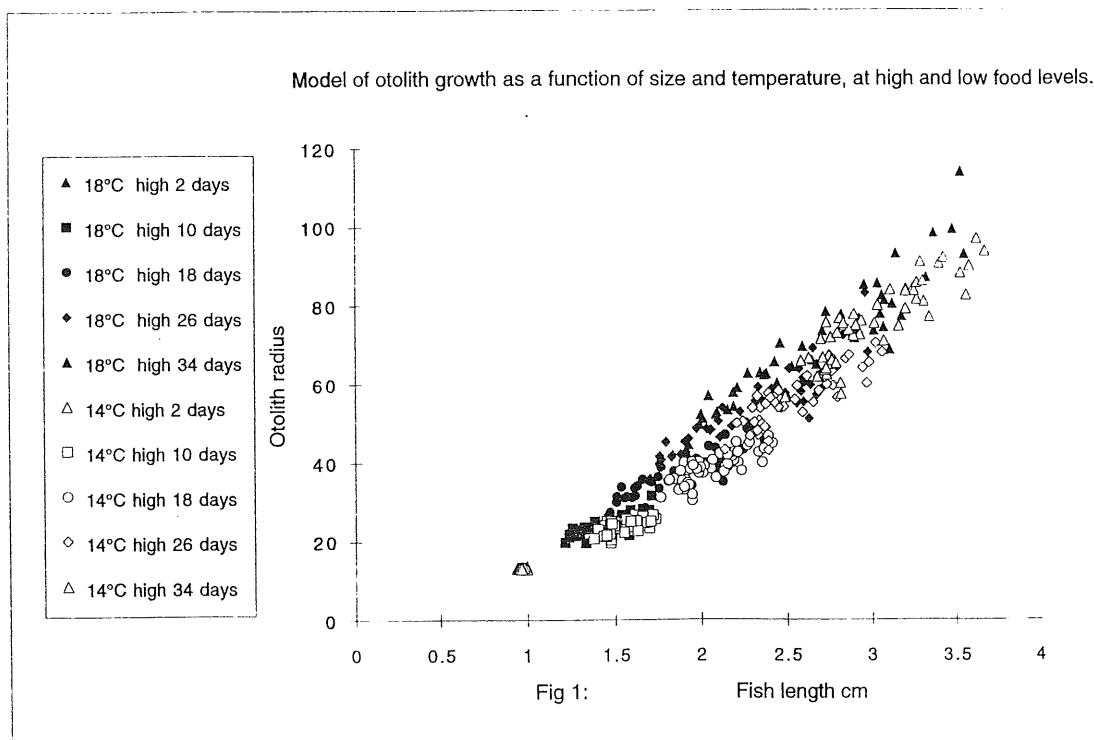

fig4



APPENDIX 4

A Brief Chronology of the Advances in Size Based Theory

Prepared by E Houde
University of Maryland System, USA

A brief chronology is presented listing some significant contributions during the past 25 years on mortality during early life stages. Body size and temperature clearly play important roles in determining rates of mortality and growth. Growth and mortality rates are correlated. The linkage cannot be ignored.

Cushing. 1975. (Marine Ecology and Fisheries, Cambridge University Press): Abundance is controlled (regulated) in early life by the "single process," (ie the link between growth and mortality).

Ware. 1975. (*J. Fish. Res. Bd Can.*, **32**, 2503-2512): Big eggs (larvae) suffer lower mortality than small eggs (larvae). Density-dependent growth is the mechanism by which abundance is regulated.

Shepherd and Cushing. 1980. (*J. du Conseil*, **39**, 160-167): Role of density-dependent growth in regulating numbers during prerecruit phase of life. Model development.

Sissenwine. 1984. (In: *Exploitation of Marine Communities*, May, R.W (ed.). Rep. Dalhem Workshop, Berlin. Springer-Verlag. pp59-94): Singled out the juvenile stage as the stage where variability in mortality rates was most likely to result in variable recruitments.

Werner and Gilliam. 1984. (*Annu. Rev. Ecol. System*, **15**, 393-425): Discuss the relationship between growth and mortality, emphasising that minimising the ratio of Z to G should be selected, especially at stage transitions, eg metamorphosis.

Peterson and Wroblewski. 1984. (*Can. J. Fish. Aquat. Sci.*, **41**, 1117-1120): Mortality rates of fish as a function of size. Application of ecosystem size structure theory to fish mortality. Eggs and larvae suffer higher mortality rates than expected. Juveniles and adults suffer lower than expected mortality rates. Suggested high predation in early life and lower predation later.

McGurk. 1986. (*Mar. Ecol. Prog. Ser.*, **34**, 227-242): Egg and larvae high mortality fitted to regression relationship relative to size. Suggested higher than expected mortality a function of patchiness which increases susceptibility to predation. Conclusion debated.

Houde. 1987. (*Am. Fish. Soc. Symp. Ser.*, **2**, 17-29): Showed that small G and Z variability within stages or size classes in egg, larval and juvenile stages could have major effects on levels of recruitment. Suggested that G was highly correlated (inversely) with Z and that estimate of G might estimate Z.

- Anderson. 1988. (*J. Northw. Atl. Fish. Sci.*, **8**, 55-66): Reviewed paradigms and hypotheses regarding recruitment variability and singled out growth rate and size-specific dynamics during early life as the major controlling factors.
- Miller, *et al.* 1988. (*Can. J. Fish. Aquat. Sci.*, **45**, 1657-1670): Reviewed and synthesised data on the size-related properties of fish larvae that could control dynamics during early life and lead to variable recruitments. Promoted the idea that size was the single, most probable factor that could be linked to both starvation and predation hypotheses as controllers of recruitment.
- Beyer. 1989. (*Dana*, **7**, 45-147): Focused on the size-controlled ecosystem concept and its relationship to stage-specific (physiological) mortality of fishes. Showed how age-specific and size-specific growth and mortality rates were related. Linked theory to applications. Pointed out that it was remarkable, given the dynamic properties of fish early life stages, that even greater fluctuations than observed in fish stock abundances did not occur, which is evidence of strong regulation of numbers during early life.
- Houde. 1989. (*J. Fish Biol.*, **35**(Supplement A), 29-38): Showed that stage-specific survivorship was more dependent upon the "subtle" differences in growth and mortality rates that could occur and which challenged capabilities to measure them during early life than on "episodic" events that caused dramatic mortalities. Showed that species with high ratios of W_{met} to W_0 and high ratios of Z to G had highest probabilities of being regulated during the larval stage, while those with lower ratios of these properties would have higher probability of being regulated later in life.
- Houde. 1989. (*Fish. Bull. US*, **87**, 471-495): Synthesised literature on growth, mortality, stage durations, and energetics properties of marine fish larvae and demonstrated that 40 to 80% of the variability in the medians of these properties across taxa could be accounted for by temperature alone. Pointed out that mortality rates, on average, probably exceeded growth rates during the larval stage, implying that biomass of larval cohorts might be declining, on average, during this stage.
- Pepin. 1989. (*Rapp. P.-v. Reun. Cons. Int. Explor. Mer*, **191**, 324-392): Called attention to fact that an increase in growth rate variability during the larval stage would lead to greater survivorship if mortality was largely predation related and size specific.
- Pepin. 1991. (*Can. J. Fish. Aquat. Sci.*, **48**, 503-518): Examined the relationship between length, temperature, and the stage-specific mortality of marine fish eggs and larvae. Found no relationship between size and stage-specific properties of eggs and yolk-sac larvae, but a strong and inverse relationship between stage-specific mortality (ie Z/G) and post-yolk-sac larval lengths. Pointed out that because Z and G were highly correlated, and both related to temperature in a similar fashion, that there was no detectable effect of temperature on stage-specific survivorship.
- Pepin and Myers. 1991. (*Can. J. Fish. Aquat. Sci.*, **48**, 1820-1828): Recruitment variability was examined in relation to egg and larval size. Size of eggs and size of larvae at hatching did not show any relationship to variability in recruitment levels, but the length increment between hatching and metamorphosis was

positively related to recruitment variability. The authors took this increment to be representative of stage duration and thus concluded that stage duration was positively correlated with recruitment variability. As the duration of the larval stage increases, cumulative mortality increases, which apparently results in greater recruitment variability.

Houde and Zastrow. 1993. (*Bull. Mar. Sci.*, **53**, 290-335): Synthesised and analysed data from ecosystems and across taxonomic groups with respect to temperature-adjusted growth, mortality, stage duration, and energetics properties of marine and fresh water fish larvae. After temperature adjustment, relatively few differences among ecosystems and taxa remained. There were some obvious differences between fresh water and marine larvae. Also, some taxonomic differences emerged.

Pepin. 1993. (*Can. J. Fish. Aquat. Sci.*, **50**, 2166-2174): Undertook a length-specific mortality analysis of fish larvae from a marine system. Showed that despite good statistical fits of abundance data regressed on larval sizes and despite good agreement of the estimated rates with the relationships between stage-specific mortalities and larval lengths based upon synthesised information for marine fish larvae, that the estimated rates were not consistent with previous estimates for these species. Pepin pointed out that assumptions of stationarity, and constant growth and mortality rates during the larval stage, probably did not hold, and that the length-specific analysis was not satisfactory under the conditions that it was applied. The need for otolith technology and age-based mortality estimates was stressed.

Pepin. 1993. (*Can. J. Fish. Aquat. Sci.*, **50**, 53-59): Biomass of larval cohorts must increase as they grow towards recruitment. Applying cohort biomass vs individual weight regressions to seven species of fish, Pepin found that good statistical fits were obtained but that the slopes of the regressions were not correlated with recruitment indices for these species. The larval production model was not adequate for comparison of potential year-class strength between species based on larval abundance estimates. The analysis does not reject the theory, in fact it supports it. But, the variability in the relationship is so great that it is not possible to link larval production to subsequent recruitments. Better sampling methods to quantify larval abundances are proposed as a possible solution.

Miller and Pepin. 1993. (*Can. J. Fish. Aquat. Sci.*, **50**, 1343-1345): Warned that results of synthesis analyses on fish early life stages and their dynamics should not be applied indiscriminantly to species for which actual data were missing. Good advice.

Houde. 1994. (*ICES J. Mar. Sci.*, **51**, 91-97): Critically examined the stage-specific differences between marine and fresh water fish larvae. Mortality rates are higher, weight-specific oxygen uptakes are higher and stage durations are shorter for marine larvae. The differences may, in large part, result because marine fish larvae weigh 10 times less than fresh water larvae at hatch. If density-dependent regulation is important during early life, it is more likely to be significant during the larval stage of marine fishes (relatively high Z to G ratio, high W_{met} to W_0 ratio).

APPENDIX 5

Basic Equations in Size Based Ecosystem Analysis

Prepared by E Houde
University of Maryland System, USA

Assumptions

1. Ecosystems are size structured.
2. Declines in biomass and numbers as a function of size are predictable.
3. Predation is the principal cause of loss.
4. Prey size is a fixed proportion of predator size.

growth	$G(w) = kw^{-x}$	G = specific growth rate w = body weight $x = 0.25$ k = weight coefficient = $4.32 \times 10^{-3} \text{ d}^{-1}$
production	$B(w)G(w) \approx w^{-c}$ $B(w) \approx w^{x-c}$	B = normalised biomass (number density = biomass/dw) ($c = 1.22$)
mortality	$M(w) = ckw^{-x}$	M = specific daily mortality rate ($M(w) = 5.26 \times 10^{-3} w^{-0.25}$)

References

- Platt, T. and Denman, K. 1978. The structure of pelagic marine ecosystems. *Rapp. P.-v. Reun. Cons. int. Explor. Mer*, **173**, 60-65.
- Silvert, W. and Platt, T. 1980. Dynamic energy-flow model of the particle size distribution in pelagic ecosystems. In: *Evolution and Ecology of Zooplankton Communities*, Kerfoot, W.C. (ed.), pp754-763. Univ. Press, New England, Hanover.
- Peterson, I. and Wroblewski, J.S. 1984. Mortality rate of fishes in the pelagic ecosystem. *Can. J. Fish. Aquat. Sci.*, **41**, 1117-1120.

APPENDIX 6

Agenda for the Working Group Meeting

Tuesday 14 June

Meeting convened 0930

- am
 - Introductions, acceptance of agenda and establishment of objectives and workplan for the meeting.
 - brief (<5 min each) status report on each task from contributors.
- pm
 - Detailed status review of growth variability analysis (data report from P. Munk and J. Modin).
 - Detailed status review of growth model development (J. Beyer)
 - Discussion and agreement of aims for analysis of data and models.
 - Formation of sub-groups to proceed with analysis.

Wednesday 15 June

Meeting convened 0900

- am
 - Review of cod and haddock checklist and proposals for future work (C. Fox pp K. Brander).
 - Review of state of the art in otolith analysis (S. Campana).
 - First session on SG on Spatial and Temporal Integration Report.
 - Formation of subgroups to critically review SG Report.
- pm
 - Sub-group work

Thursday 16 June

Meeting convened 0900

- am
 - Plenary session:
 - Brief progress reports from sub-groups.
 - Review of studies relating size, growth and mortality in fish larvae (E. Houde).
 - Sub-group work.
- pm
 - Sub-group work and report writing.
 - Plenary session on SG on Spatial and Temporal Integration Report - outcome from sub-groups.
 - Circulation of written material from sub-groups.

Friday 17 June

Meeting convened 0900

- am
 - Election of new chairman.
 - Detailed presentations from growth and modelling sub-groups.
 - Review and acceptance of written contributions to final report.
- pm
 - Compilation of final report.
 - Free presentations of recent research by participants (approximately 5-10 min each).
 - Meeting close.

TABLE 1

Details of otolith microstructure data available to the Working Group

Set	Species	Data sets provided by	No hauls	Total no individuals	Size range (mm)	Age (days)	Increment widths	Weight measure	Temp (°C)	Prey info
1	Cod	John Anderson	27	179	29.5-67.0	19-87	n/a	n/a	n/a	n/a
2	Cod	Steve Campana	50	362	2-30	1-70	n/a	n/a	2-9	n/a
3	Cod	Iain Suthers	35	335	6.3-29.0	1-69	n/a	individual	10.2-18.1	copepod nauplii
4	Cod	Peter Munk	2	60	12-34	30-75	n/a	converted	7.6-8.2	prey biomass
5	Herring	Mike Heath	17	117	6.4-22.7	1-33	available	converted	10.9-12.0	prey biomass
6	Herring	Erlend Moksness	35	286	6-28	2-60	n/a	individual	9.5-18.5	prey density
7	Herring	Dietrich Schnack		191	7-22	1-28	available	converted	10.6-13.1	n/a
8	Sandeel	Mike Heath	39	277	4.2-18.3	1-28	available	individual	7.4-9.2	chlorophyll
9	Sprat	Peter Munk	16	804	4-23	2-58	n/a	converted	13.6-16.9	chlorophyll
10	Smelt	Aquiles Sepulveda	39	191	7.5-21.5	1-27	available	converted	16.2-18	n/a

Set	Study area	Period	Sampling gear used
1	Nfld shelf, Canada	Oct 1992	IYGPT
2	Browns Bank, Canada	Jan-Jun 1985	Bongo nets
3	Northern Norway		Pelagic trawl
4	Skagerrak	May 1992	MIK (ring net 1.2 mm)
5	Orkney Isles, North Sea	Sept 1986	Gulf III and Vertical net (200 µm)
6	Mesocosm, North Sea	Sept, Oct 1991	2-chambered plankton net (500 µm)
7	Shetland-Orkney	Apr, Mar 1993	Gulf III
8	Northern North Sea	Apr 1992	Gulf III
9	Eastern North Sea	Aug 1989	MIK (ring net 1.2 mm)
10	Elbe estuary	Apr, May 1993	Ringtrawls (300 µm, 1,000 µm)

TABLE 2

Summary of log-log regressions of otolith radius versus fish length

Species	Source	Intercept	Slope	R ²	Lengths
Φ					
Herring	Schnack	0.202	1.016	67	5.2-22.3
Herring	Moksness	-0.972	2.137	91	6.3-29
Herring	Heath	-0.056	1.262	70	6.4-22.7
Cod	Suthers	0.641	1.077	92	11.9-39.9
Cod	Anderson	0.862	0.938	55	29.5-67.0
Cod	Munk	1.094	0.662	44	11.0-33.5
Sandlance	Heath	0.561	0.672	65	4.2-18.3
Sprat	Munk	-0.395	1.820	83	5.0-23.2

RPWG Growth study (Length vs. rings)

Cod larvae/juveniles

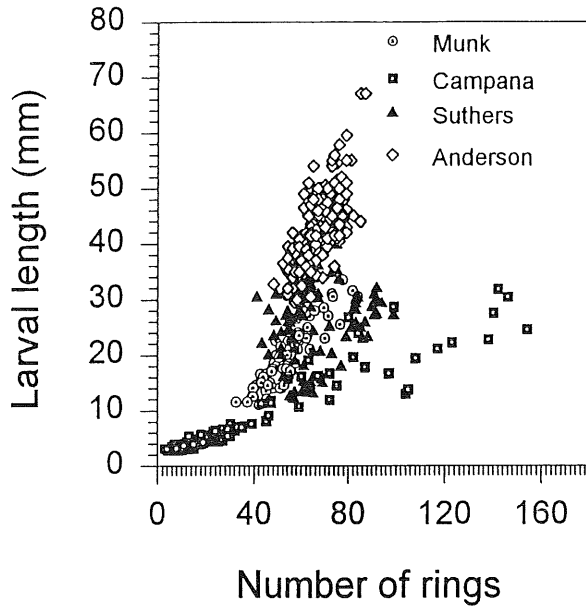

Herring larvae

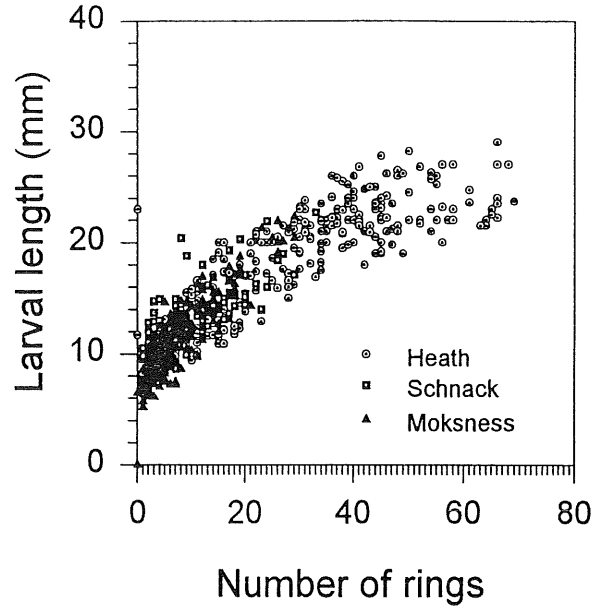

Sprat larvae

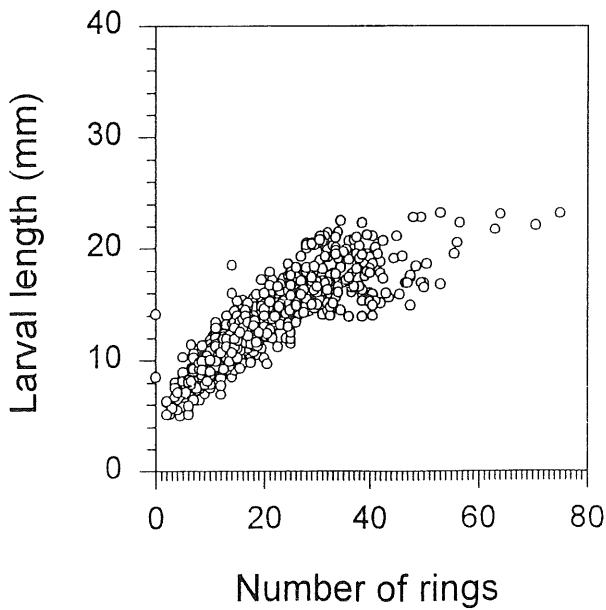

Sandeel larvae

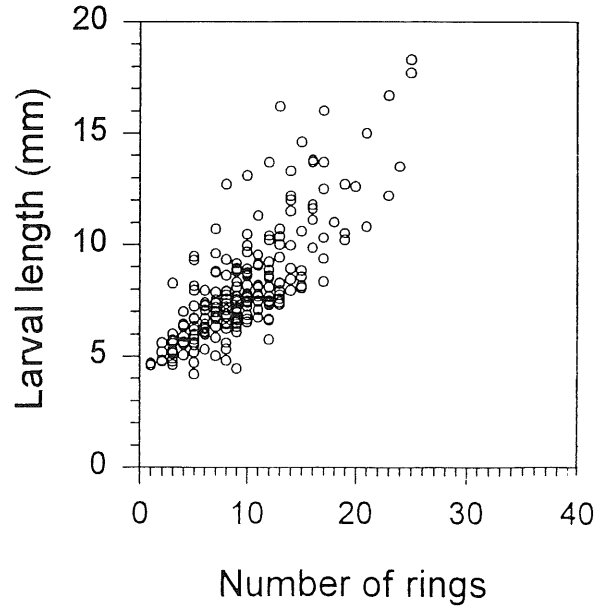

Figure 1 Relationships between body length and total ring count at capture of cod, herring, sprat and sandeel.

RPWG Growth study (O-radius vs. rings)

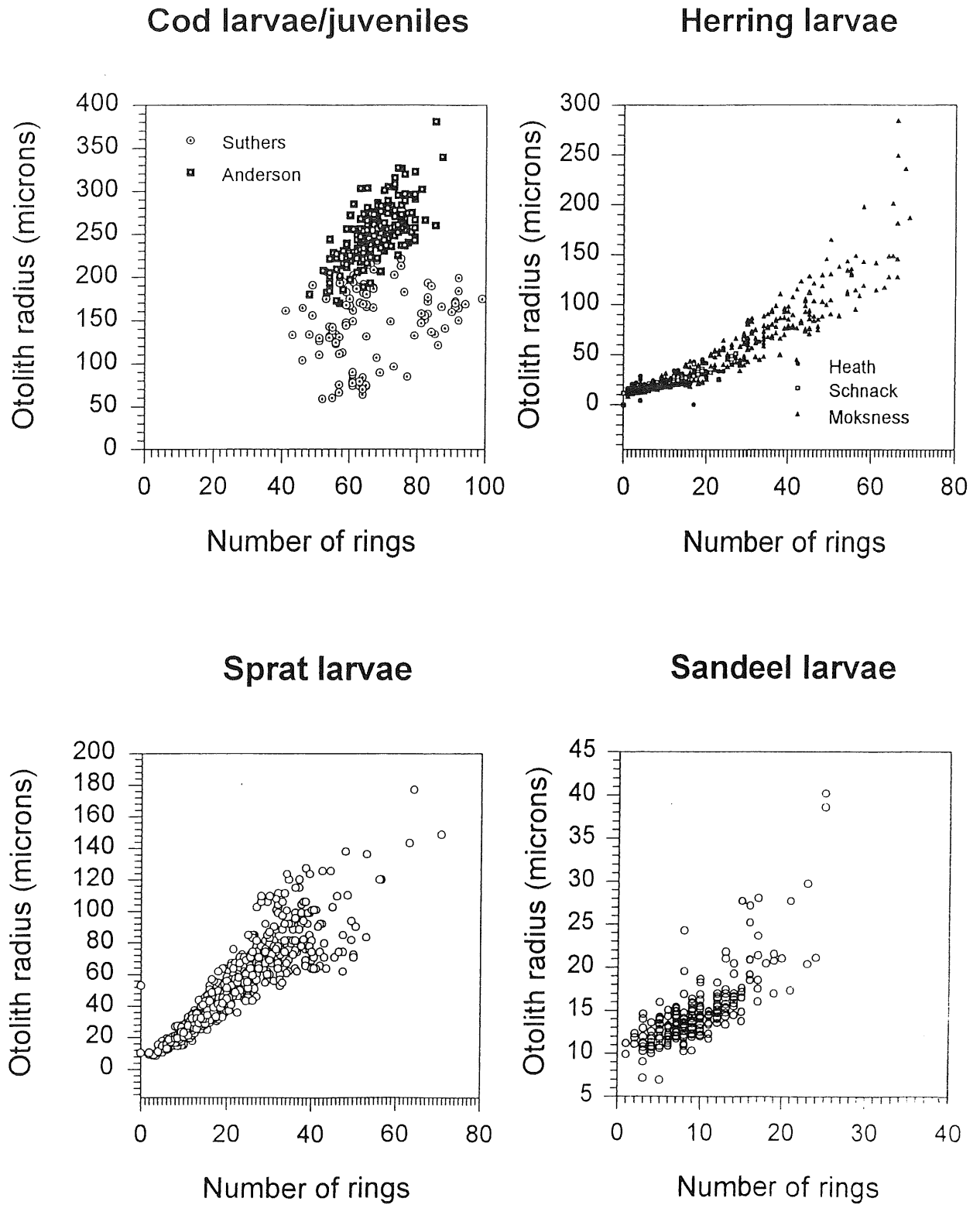
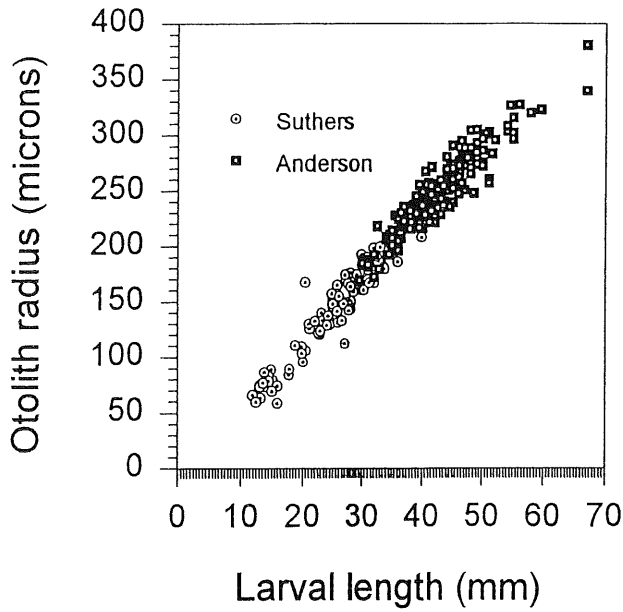

Figure 2 Relationships between total ring count and otolith radius at capture of cod, herring, sprat and sandeel.

RPWG Growth study (O_radius vs. length)

Cod larvae/juveniles



Herring larvae

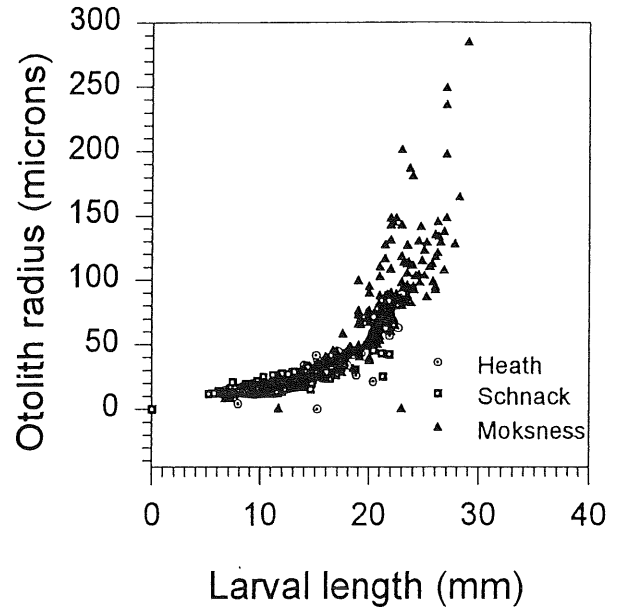

Sprat larvae

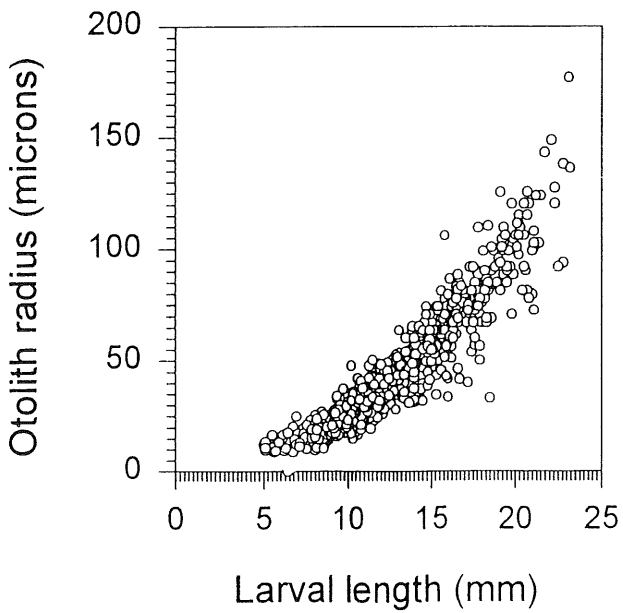

Sandeel larvae

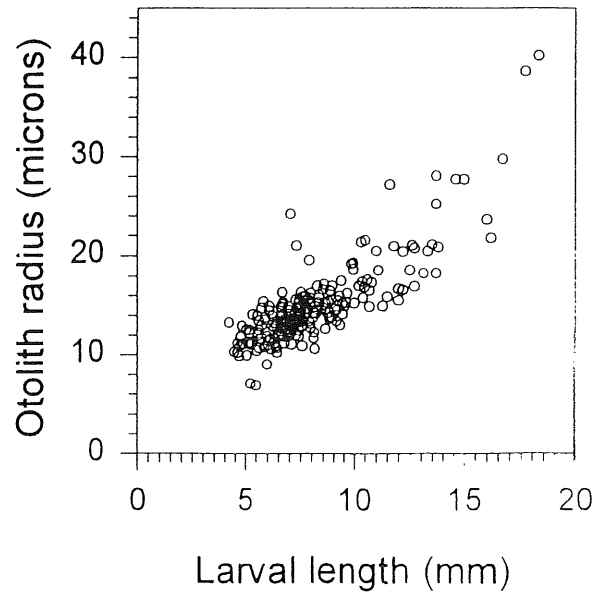
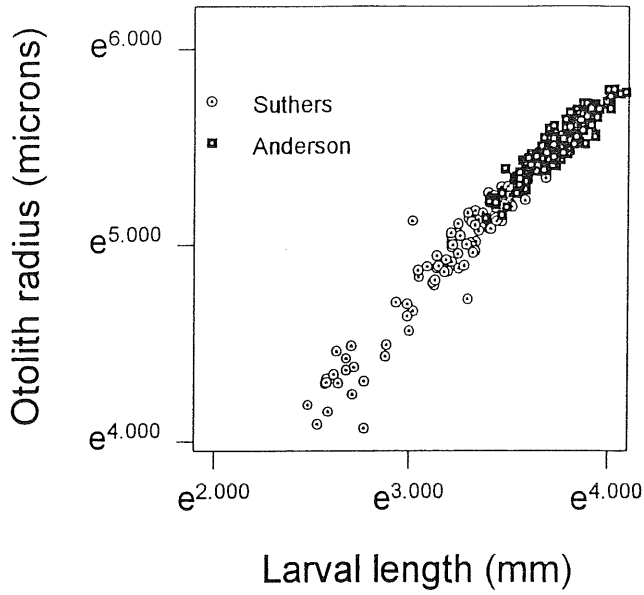

Figure 3 Relationships between body length and otolith radius at capture of cod, herring, sprat and sandeel.

RPWG Growth study (ln scaled O_radius vs length)

Cod larvae/juveniles



Herring larvae

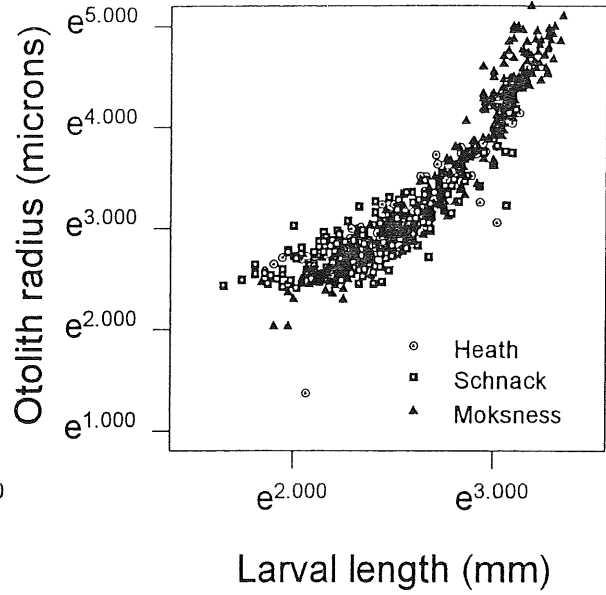

Sprat larvae

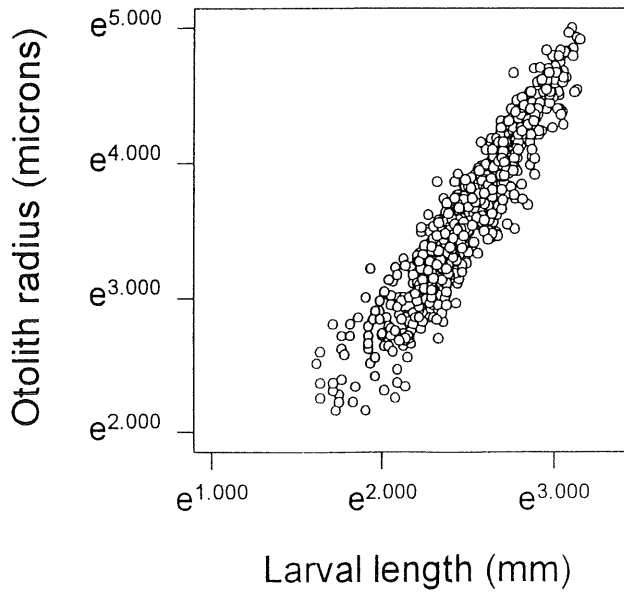

Sandeel larvae

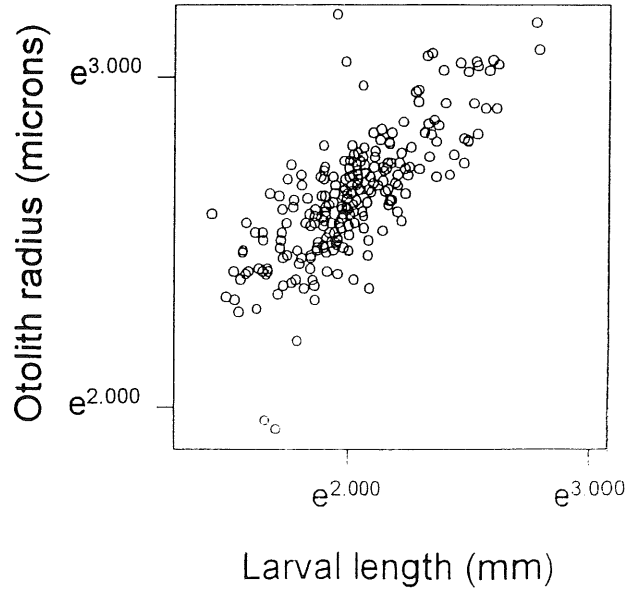

Figure 4 Relationships between log-transformed body length and otolith radius at capture of cod, herring, sprat and sandeel.

RPWG Growth study (analysis of third ring width)

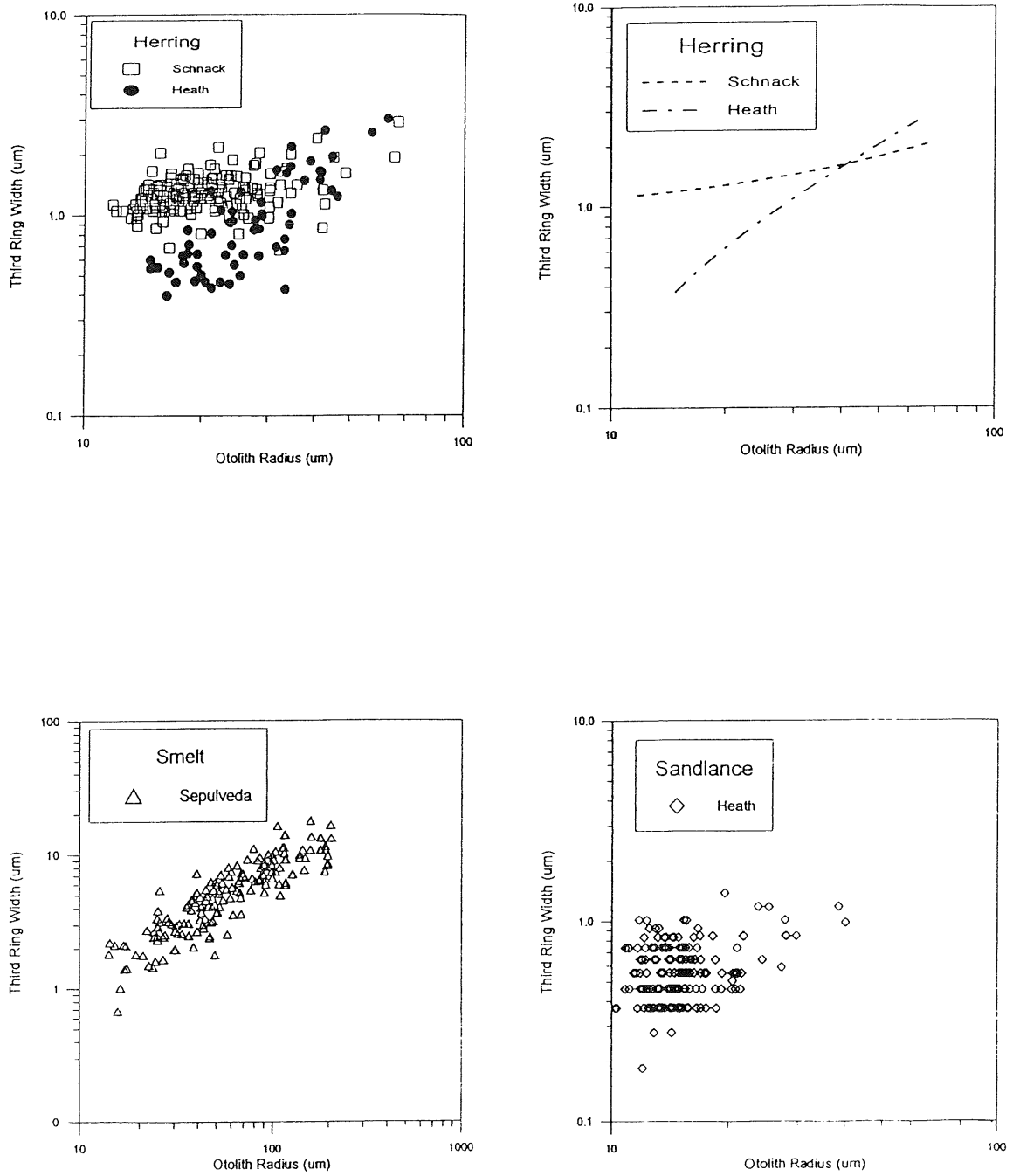

Figure 5 Relationships between otolith radius at capture and the width of the third most recently deposited ring for herring, smelt and sandeel.

RPWG Growth study (third ring width vs. temperature)

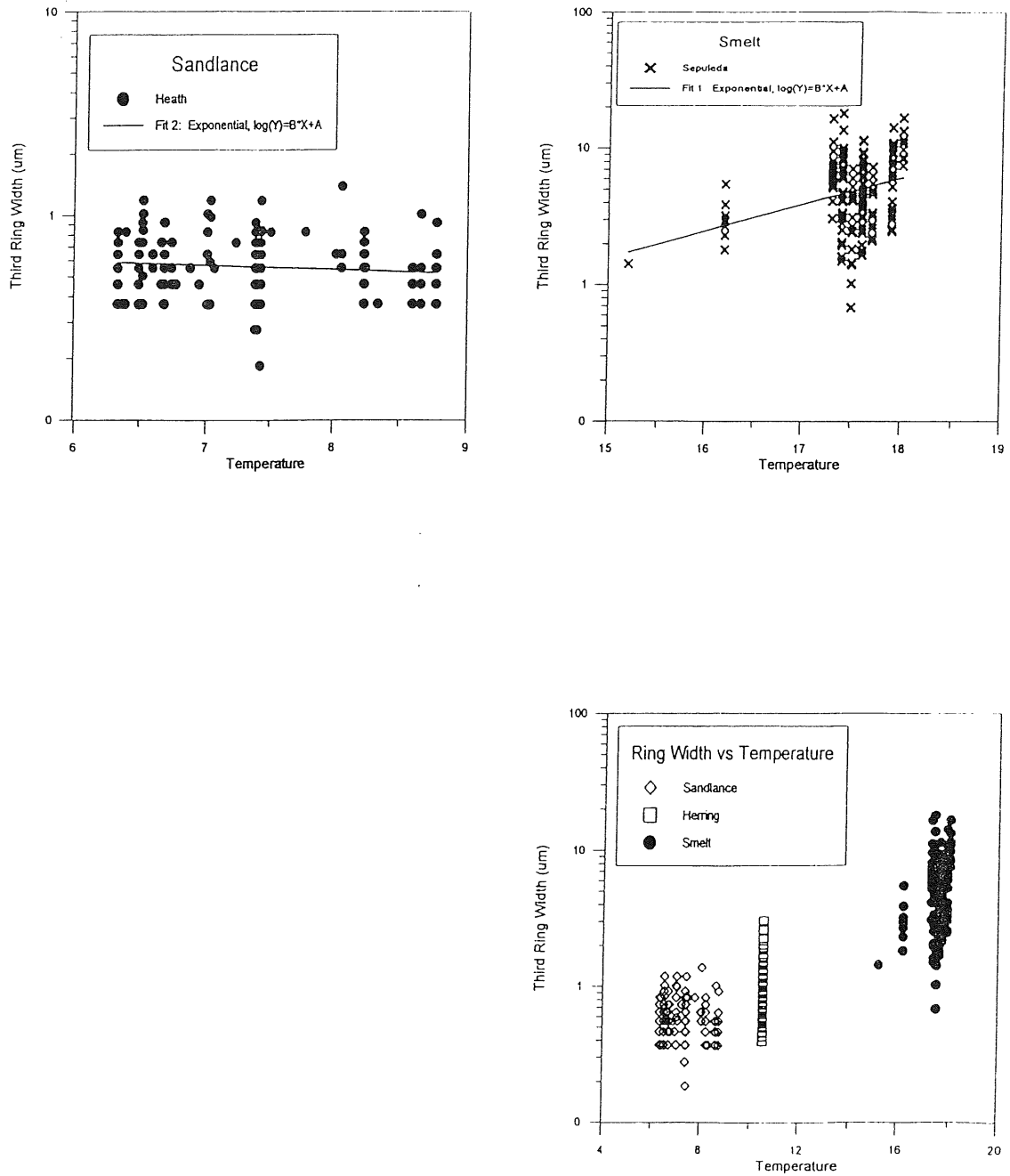

Figure 6 Relationships between temperature at the capture site and the width of the third most recently deposited ring for sandeel and smelt, together with an equivalent graph combining data from three different species to enhance the temperature contrast.

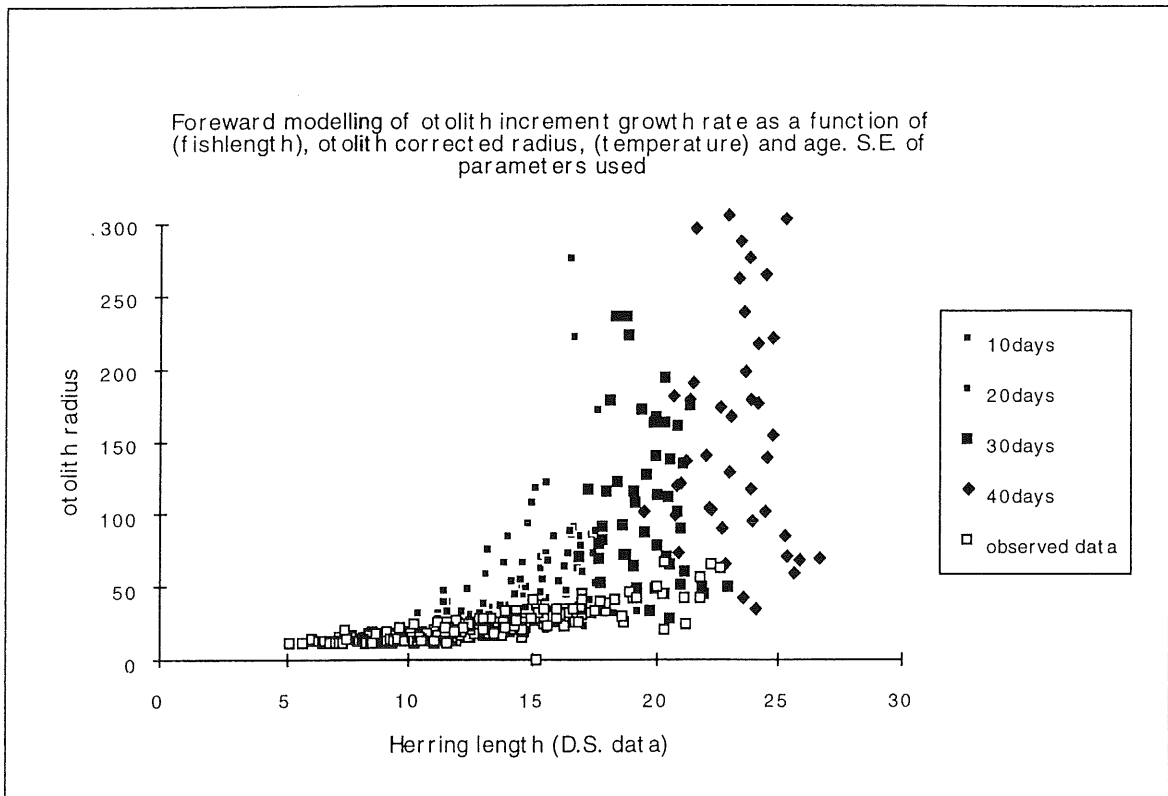

Figure 7 Results from a forward prediction model of herring otolith size as a function of fish length based on regression estimates of the parameters of the relationship between Ring3 increment width and length, age, temperature and otolith radius. Stochasticity was entered by assuming a normal distribution of parameter standard errors around the mean.

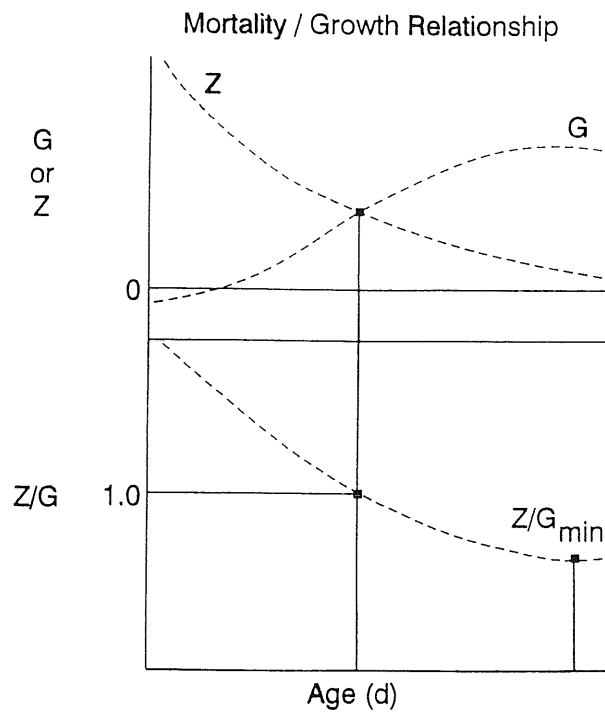

Figure 8 Hypothetical relationships between instantaneous mortality and growth rates (Z and G) and age (or size). At the point $Z/G = 1.0$ cohort biomass begins to increase. At the point $(Z/G)_{\min}$, cohort biomass is increasing at maximum rate. It is hypothesised that this point occurs late in the larval or early in the juvenile stage.

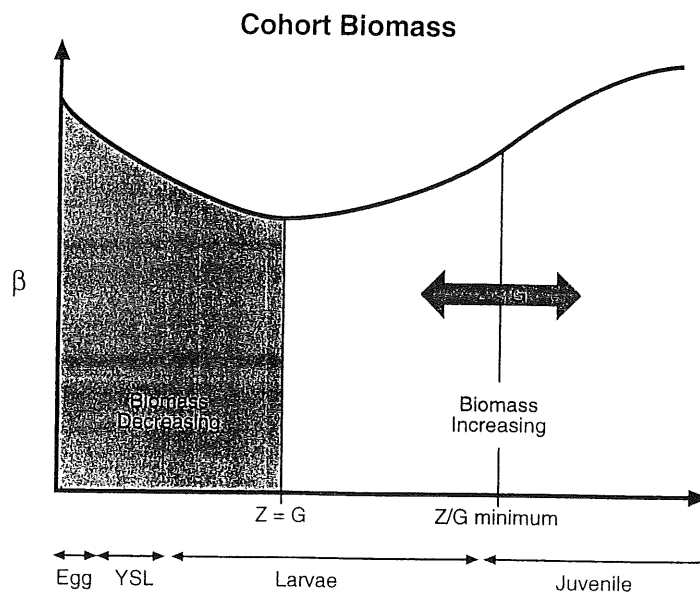

Figure 9 Hypothetical changes in cohort biomass during the egg, yolk-sac larva, feeding larva, and juvenile stages, showing the proposed relationships with mortality (Z) and weight-specific growth (G) coefficients.