

Fol. 41 B

Fisheriödirektoratets
Bibliotek

Not to be cited without prior reference to the authors

International Council for the
Exploration of the Sea

CM 1991/B:54
Fish Capture Committee
Theme Session U
Application and Analyses
of Acoustic Methods

SURVEY DESIGN AND ANALYSIS PROCEDURES: A COMPREHENSIVE REVIEW OF GOOD PRACTICE

by

E. John Simmonds¹, Neal J. Williamson², François Gerlotto³ and Asgeir Aglen⁴

1 SOAFD, Marine Laboratory, PO Box 101, Aberdeen, Scotland.

2 National Marine Fisheries Service, 7600 Sand Point Way NE, Seattle, Washington
98115, USA

3 ORSTOM, BP 5045, 34032 Montpellier, Cedex 1, France.

4 Inst. Marine Research, PO Box 1870 N-5024 Bergen, Norway

SUMMARY

This paper provides a major review of acoustic survey and data analysis procedures, it has been prepared as a result of discussions in the FAST working group of ICES. A review of published literature is combined with an assessment of methodology. A consideration of information available *a priori* and its impact on the choice of survey area and survey design is presented. The subject of predetermined survey tracks using both systematic and random strategies is addressed, indicating the assumptions implied by these choices. Adaptive strategies that might be required for mobile or less predictable spatial distributions are discussed along with the advantages and the costs of an adaptive approach. The methods of determining of stock species composition are examined. The methods for assessing the degree of homogeneity species size and proportion are presented.

The important choice of averaging method i.e. how the samples provide information on the true density within an area is examined. Sources of error within the estimate are discussed. Firstly, methods for computing the spatial sampling error are examined, and secondly, a summary of other sources of error is presented. A appraisal of these errors is presented and provides an intrinsic error analysis. Finally a brief comparison of the results of acoustic surveys with the results of other techniques is presented.

Throughout the paper the assumptions implicit in each choice are discussed, and appropriate selections of survey design and analysis methods are presented in tabular form. The paper concludes with a summary of recommended procedures.

3107/12 4854

TABLE OF CONTENTS

1 INTRODUCTION	4
1.1 <u>Acknowledgements</u>	4
2 OVERVIEW	4
2.1 <u>General</u>	4
2.2 <u>Symbol list</u>	5
2.3 <u>Definitions and assumptions</u>	12
3 SURVEY DESIGN	15
3.1 <u>Definition of survey area</u>	16
3.1.1 Stratification	18
3.2 <u>Track design</u>	20
3.2.1 Predetermined track designs	21
3.2.1.1 Direction	21
3.2.1.2 Systematic vs. random sampling	22
3.2.1.3 Systematic zig-zag	22
3.2.1.4 Systematic parallel	22
3.2.1.5 Stratified random parallel	23
3.2.1.6 Cross-transects	23
3.2.1.7 Discussion	23
3.2.2 Adaptive track designs	25
3.2.2.1 Outline survey	26
3.2.2.2 Variable transect length	26
3.2.2.3 Variable transect spacing	26
3.2.2.4 Summary	27
3.3 <u>Biological sampling</u>	28
3.3.1 General	28
3.3.2 Fishing gear	29
3.3.2.1 Trawls	30
3.3.2.2 Purse seines	31
3.3.2.3 Gill and drift nets	32
3.3.3 Species identification by other methods	32
3.3.3.1 Visual methods	32
3.3.3.2 Acoustic methods	33
3.3.3.3 Survey application	34
3.4 <u>Calculation of survey time/track length</u>	36
3.5 <u>Interval for averaging (ESDU)</u>	37
4 DATA ANALYSIS	38
4.1 <u>Species composition</u>	38
4.1.1 Partitioning (Judging) echo integrals or counts	38
4.1.2 Analysis of fishing samples	39
4.1.2.1 Combining length samples	40
4.1.2.2 Combining species proportions	40
4.1.2.3 Testing for regions of homogenous length or species proportion.	41
4.2 <u>Spatial Averaging</u>	41
4.2.1 General principles	41
4.2.2 No stratification	44
4.2.3 Stratification in transects	45
4.2.4 Stratification in blocks	45
4.2.5 Contouring	46

4.2.6 Stratification in rectangles	49
4.2.7 Geostatistics	50
4.2.8 Summary (comparison)	52
4.3 <u>The Echo-integrator Conversion Factor</u>	53
4.3.1 Single species	53
4.3.2 Mixed species	54
4.3.3 Weight-length relationships	55
4.4 <u>Abundance Estimation</u>	56
4.5 <u>Errors of the estimate</u>	56
4.5.1 Spatial sampling errors	56
4.5.1.1 Multiple or repeat surveys	58
4.5.1.2 Bootstrap	59
4.5.1.3 Degree of coverage	60
4.5.1.4 Cluster Analysis	61
4.5.1.5 Ratio estimator	63
4.5.1.6 Transform methods	64
4.5.1.7 Geostatistics	65
4.5.2 Species allocation error	73
4.5.2.1 Fishing	73
4.5.2.2 Acoustic species allocation	73
4.5.3 Effect of fish behaviour	74
4.5.3.1 Effect of spontaneous behaviour	74
4.5.3.2 Effect of the reactions of the fish to a survey vessel	81
4.6 <u>Additional errors</u>	83
4.6.1 Equipment	83
4.6.2 Transmission losses	83
4.6.2.1 Temperature and Salinity variation	83
4.6.2.2 Bubbles	84
4.6.2.3 Fish	84
4.6.3 Transducer motion	85
4.6.4 Noise and reverberation	86
4.6.5 Target Strength (Backscattering cross section)	86
4.7 <u>Summary</u>	88
4.7.1 Error of an acoustic index	89
4.7.2 Error of absolute abundance estimates	90
5 DISCUSSION	90
5.1 <u>Comparison between stock types</u>	90
5.2 <u>Comparison with other methods</u>	91
6 CONCLUSIONS	93
7 REFERENCES	94
APPENDIX I	i

1 INTRODUCTION

This report has been prepared as a result of discussions in the Fisheries Acoustics Science and Technology (FAST) working group of the International Council for the Exploration of the Sea (ICES). Following discussions in Seattle, United States in 1987 and Oostend, Belgium in 1988, a questionnaire on survey and data analysis practices was circulated to the working group participants. Replies were received from Canada, Denmark, Finland, France, Iceland, Norway, Poland, Scotland, Sweden and United States. The responses were compiled, presented, and discussed at the working group meeting in Dublin, Ireland in 1989 (Simmonds, 1989). Further discussions were held in Rostock, Germany in 1990 and it was decided to prepare a report to review acoustic survey and design procedures for abundance estimation and to recommend a number of suitable acoustic survey procedures. This report was prepared throughout 1990 and 1991, and a draft was presented and discussed at the working group meeting in Ancona, Italy in April 1991.

Acoustic surveys have been used in stock assessment for more than two decades and form both an important part of routine stock management and exploratory surveys of new areas. As a survey tool acoustics may be used to cover large sea areas over a period of a few weeks, or to provide detailed repeated coverage of small areas in a few hours. Surveys often require expensive research vessel time and it is important to make good use of these resources. The survey requires (a) well calibrated survey equipment, (b) a knowledge of the scattering properties of targets which give the echoes, and (c) an understanding of how the acoustic samples relate to the whole stock being surveyed. Equipment calibration has been described in detail by Foote et al (1987). Fish target strength and how it varies is a major topic in its own right and outside the scope of this document. Here, we address primarily the relationship between the survey design, the samples obtained on a survey, and the estimates of abundance. Where it is possible, we make clear recommendations on suitable methodology. For particular survey designs and analysis techniques, we indicate the assumptions that are inherent in each approach and show clearly which methods are mutually incompatible. In preparing this report, we have concentrated on the major uses of acoustics for stock abundance surveys. We have limited our review to considerations of 'small' pelagic species observed with a vertical sounder. We have excluded investigations of large pelagic fish such as tuna, and observations with sideways-looking sonars either in rivers or the sea. While some reference has been made to salmonoid stocks in lakes, migrating salmon in rivers have been excluded from this study.

1.1 Acknowledgements

We would like to thank all the members of the Fisheries Acoustics Science and Technology Working Group for their useful comments and helpful discussion of this paper. In particular we would like to thank Pierre Petitgas for providing the main part of section 4.5.1.7 on geostatistics and for his efforts in ensuring it remained correct during editorial stages. We would also like to thank Robert Keiser, Dave Reid and David MacLennan for their effort reading parts or all of the document in draft and for their useful comments.

2 OVERVIEW

2.1 General

A good survey design and careful appropriate analysis of the data will yield good results. In contrast, increased expenditure of resources in an attempt to increase the quality of a fundamentally flawed survey will produce little or no improvement. The purpose of this document is to detail the best survey design practices and the associated data analysis methods. It is important to remember that the survey plan, the data collection, and the data analysis must form a coherent process to attain the desired objective. A good survey plan uses all a priori information on a stock to define the most suitable survey method and the correct method for evaluating the desired information from the data. In this document, we draw on the earlier reviews of Shotton and Bazigos (1984) and Johannesson and Mitson (1983). We bring together current practices from a wide experience of different stocks both personal and from within this FAST working group. We would like to emphasise the

developing state of understanding in this field, and in particular we look forward to greater understanding of fish stocks and their distributions and thus improvement in measurement techniques.

In making a choice of one particular survey design and analysis method, you will have made some assumptions about the stock and its distribution. It is important to recognise what these assumptions are and to be sure that they can reasonably be said to apply to the stock you are surveying. Throughout this report, we present a number of approaches to survey problems and highlight the assumptions inherent in each choice. The report is structured in 5 sections. Sections 1 and 2 provide an introduction and overview. In section 2 is included a list of symbols and a collection of definitions used throughout the text. Sections 3 and 4 contain the main body of the report. Section 3 describing the planning and data collection stages, and section 4 the data analysis methods to provide stock density and abundance estimates. We also examine the errors in the estimate in this section. Then finally, in section 5, we provide a discussion of different stocks and some comparisons of estimates derived from acoustic surveys with those from other techniques.

In section 3.1 on survey design, we start with a consideration of the use of a priori information and its impact on the choice of survey area and the type of survey design. In section 3.2, we address the subject of predetermined survey tracks using both systematic and random strategies. We indicate the assumptions implied by these choices. Next we discuss possible adaptive strategies that might be required for mobile or less predictable spatial distributions. Here we stress both the advantages and the costs of an adaptive approach. We briefly address the requirements for biological samples to provide species identification, size composition, and age structure for a stock in section 3.3. Here also we look in some detail at alternative methods of species identification. In section 3.4, we provide basic guidelines for the calculation of survey track layout and allocation of sampling effort. Finally, within the survey design section, we discuss the choice of averaging interval.

In section 4.1 of the data analysis section, we look first at the subject of species composition of the survey stock, and examine the degree of homogeneity of species size and proportion. We discuss the possibilities of determining regions within the survey area with homogeneous species size and proportion. In section 4.2, we look at the important choice of averaging method i.e. how the samples provide information on the true density within the area. In sections 4.3 and 4.4, we provide the basic equations for converting echo-integrator output to estimates of density and total abundance. In sections 4.5 and 4.6, we examine the sources of error within the estimate. Firstly by examining the spatial sampling error and secondly briefly mentioning other sources of error. In section 4.7, we summarise these findings and provide an intrinsic error analysis.

In section 5, we briefly compare some of the different problems caused by particular fish stocks to illustrate some practical solutions. Finally we conclude with a brief comparison of the results of acoustic surveys with those from other techniques.

2.2 Symbol list

Section 2.3 Definitions and assumptions

y_i	sample value
n	number of samples
\bar{y}	estimated mean
s^2	sample variance
cv	coefficient of variation
se	standard error
r_j	correlation coefficient at lag j
	population mean
σ^2	population variance

Section 3.1.1 Stratification

h	stratum number
A	total survey area
A_h	area of stratum h
n_h	sample number in stratum h
\bar{y}_h	sample mean density in stratum h
s_h^2	sample variance in stratum h
n	total sample number in survey area
\bar{y}_{st}	stratified mean density for total survey area
$\text{var}(\bar{y}_{st})$	variance of the stratified mean density
$\text{cv}(\bar{y}_{st})$	coefficient of variation of the stratified mean density

Section 3.2.1.7 Discussion

t_e	time period
-------	-------------

Section 3.3.1 General

P_s	proportion of sardine biomass in schools
P_B	proportion of school biomass in total biomass
B_s	sardine biomass
B_t	total biomass

Section 3.4 Calculation of survey time/track length

a_1, a_2	side-lengths of a rectangular area
A	size of the area to be surveyed
C	time for calibrating the acoustic instruments
D	total length of the cruise track
F	fishing time
H	time for hydrographic stations
L	time for loading and unloading the ship
M	time for travelling to and from the survey area
N_t	number of transects
P	proportion of the day when echo-integration is useful
W	time that will be unusable due to weather
S_t	average distance between successive transects
T	total time available for surveying and related activities
v	speed of the survey vessel

Section 4.1.2.1 Combining length samples

n	number of samples
f_i	average fraction of length group i
f_{ij}	fraction of length group i in sample j
a_j	weighting factor for sample j
n_j	number measured
c	minimum size for a good sample

Section 4.1.2.2 Combining species proportions

n	number of samples
f_s	average fraction of species s
f_{sj}	fraction of species s in sample j
a_j	weighting factor for sample j

Section 4.2.1 General principles

x, y	random variables
e	error term
s_x^2	variance of x
s_y^2	variance of y
s_e^2	variance of e
H	number of strata
\bar{y}_h	mean density of stratum h
n_h	number of ESDU in stratum h
N_h	actual number of individuals in stratum h
y_{jh}	ESDU value i in stratum h
s_h^2	sample variance of density in stratum h
B_h	biomass in stratum h
A_h	area of stratum h
A	total survey area
B_{st}	total biomass (stratified)
$\text{Var}(\bar{y}_{st})$	variance of mean density
$\text{Var}(B_{st})$	variance of total biomass

Section 4.2.5 Contouring

$\text{Var}(y_{st})$	Variance of mean density within a contoured strata
$\text{Var}(y)$	Variance of total mean density
H	number of strata

Section 4.3 Echo-integrator conversion factor

F_i	estimated area density of species i
K	physical calibration factor
$\langle \sigma_i \rangle$	mean acoustic cross-section of species i
E_i	partitioned echo-integral for species i
c_i	echo-integrator conversion factor for species i

Section 4.3.1 Single species

TS	target strength
a_i, b_i	constants in the target strength to fish length formula
L	fish length
σ_i	acoustic cross-section
$\langle \sigma_i \rangle$	mean acoustic cross-section of species i
L_j	fish length at midpoint of size class j
f_{ij}	relative length frequency for size class j of species i
σ_{bs}	acoustic backscattering cross-section

c_i echo-integrator conversion factor for species i
 K physical calibration factor

Section 4.3.2 Mixed species

F_i fish density of species i
 w_i proportion of species i in trawl catches
 K physical calibration factor
 $\langle \sigma_i \rangle$ mean acoustic cross-section of species i
 E_m echo-integral of a species mixture
 c_i echo-integrator conversion factor for species i

Section 4.3.3 Weight-length relationships

W weight
 L length
 TS_n target strength of one fish
 TS_w target strength of unit weight of fish
 a_n, b_n constants in formula relating TS_n to fish length
 a_w, b_w constants in formula relating TS_w to fish length
 a_f, b_f constants in the fish weight-length formula
 ΔL interval between successive size classes
 L_j fish length at midpoint of size class j
 W_t total weight of fish sample

Section 4.4 Abundance estimation

A_k area of the elementary statistical sampling rectangle k
 Q total biomass
 Q_i total biomass for species i

Section 4.5.1.1 Multiple or repeat surveys

Q_j biomass estimate for survey j
 n number of surveys
 Q mean biomass estimate
 $\text{var}(Q)$ variance of biomass estimate
 $\text{SD}(Q)$ standard deviation of biomass estimate
 $\text{CV}(Q)$ coefficient of variation of biomass estimate

Section 4.5.1.2 Bootstrap

x random variable
 y_i sample values
 $F(y)$ cumulative probability distribution of x
 $F^{-1}(x)$ inverse function
 Q total abundance

Section 4.5.1.3 Degree of coverage

CV coefficient of variation

DOC	degree of coverage
a,b	constants in CV-DOC formula
N	sailed distance of survey
A	survey area

Section 4.5.1.4/5 Cluster analysis and Ratio estimator

y_{ij}	density observation j on transect i
n_i	number of observations on transect i
y_i	sum of densities on transect i
\bar{y}	overall mean density
$\text{var}(\bar{y})$	variance of the overall mean density
N	total number of observations
V_r^2	square of coefficient of variation for overall mean density
f	sampling fraction
t	number of transects
\bar{n}	mean number of observations per transect
\hat{V}^2	sum of between and within components of variation
B^2	between or inter-transect component of variation
W^2	within or intra-transect component of variation
δ	index of intra-transect correlation
\bar{y}_i	mean density of transect i
\bar{y}_t	mean of transect means

Section 4.5.1.5 Transform methods

F	random variable
P(F)	Gaussian probability density function (PDF)
μ	population mean
σ^2	population variance
F	arithmetic average
s^2	sample variance
λ	Power of F_i in the transformed density

Section 4.5.1.6 Geostatistics

Z(x)	value of a regionalised variable at x
x	geographical position of a sample
E[]	expected value
m	true mean of Z(x)
h	vector distance between between two geographical positions
C(h)	covariance between points x and x+h
$\Gamma(h)$	variogram at distances h
N(h)	number of pairs of geographical points at distance h
α, β	indices of sample pairs
o	index of the point to be estimated
x_o	unsampled location
x_α	sampled location
$Z^k(x_o)$	Kriged estimate of value at unsampled location
λ_α	weighting factors for the sample α
λ_β	weighting factors for the sample β

σ_k^2	kriging variance
$\sigma_{\alpha\alpha}$	covariance for the distance $ x_0 - x_\alpha $.
$\sigma_{\alpha\beta}$	covariance for the distance $ x_\alpha - x_\beta $
σ_∞	covariance for infinite distance
μ	Lagrange multiplier
v	area of block
$Z_v(x_0)$	mean density in block v centred on point x_0
$Z_v^k(x_0)$	kriging estimate in block v centred on point x_0
$\sigma_{\alpha v}$	mean value of the covariance between point x_α and another point x which takes successively all positions in v
σ_{vv}	mean value of covariance between 2 points x and y which take successively all positions in v
γ	function used to approximate the variogram

Systematic sampling regime

Q	total abundance
a	sample spacing/inter-transect distance
k	sample number
n	number of samples
x_0	the origin of the survey grid
$g(h)$	covariogram
σ_{est}^2	variance of the estimate
$\gamma(v,v)$	total dispersion of the values in the area
$\gamma(v,n_\alpha)$	approximation of $\gamma(v,v)$ of first order
$\gamma(n_\alpha,n_\beta)$	approximation of $\gamma(v,v)$ of second order
l_i	length of transect i
m_i	arithmetic mean of the samples along transect i ,
Z_i	i^{th} sample value
N	total number of samples in all strata
σ_i^2	variance of the estimate of the mean for a rectangle a

Random stratified sampling regime

w_i	weighting factor of the i^{th} strata
m_i	mean of the i^{th} strata
n_i	number of samples in strata i
$\sigma^2(o,v_i)$	variance of strata estimate.
v_i	strata i
x_α	randomly located sample in v_i
σ_{est}^2	variance of estimate from one fixed sample at x_α
γ_m	function for overall variogram
γ_{i2}	function for variogram of strata i
s_i^2	sample variance in strata i
s^2	sample variance of the full data set
γ_o	function for variance scaled variogram
$\sigma_o^2(o/v_i)$	dispersion variance

Section 4.5.3.1 Effect of spontaneous behaviour

B_P	biomass of population P
A	total area covered by fish distribution

A_s	survey area
Q	biomass of population
F_A	fish density in A
F_s	fish density in survey area A_s
v_f	migrating speed of fish
v_s	speed of progress of survey in direction of migration
$E[Q]$	estimate of biomass Q
h	height of the blind zone near bottom
d	total depth
c	speed of sound
τ	pulse length
θ	angle of the beam

Section 4.6.1 Equipment

ψ	solid angle covering the equivalent ideal beam
--------	--

Section 4.6.3 Transducer motion

d	distance sailed between transmission and reception of echo
$\Delta\alpha$	angular change between transmission and reception of echo
Δt	time lag between transmission and reception of echo
c	speed of sound
R	range to target
v	vessel speed

Section 4.6.5. Target strength (backscattering cross section)

TS	target strength
σ	backscattering cross section

Section 4.7 Summary

\hat{V}	total variance of the estimate
\hat{Q}	total abundance estimate
ε_i^2	expected value of the variance of the proportional error

Section 5.2 Comparison with other methods

Q_a	abundance estimate from method A
Q_b	abundance estimate from method B
V_a	variance of abundance estimate from method A
V_b	variance of abundance estimate from method B
V	variance of $(Q_a - Q_b)$

Appendix 1 Power transformations

F_i	fish density observation
N	number of observations
Y_i	transformed fish densities
λ	power of F_i in the transformed density

m	sample mean of transformed fish densities
S	residual sum of squares of transformed fish densities
\hat{F}	estimated mean of true fish density
\hat{V}	variance of estimated mean of true fish density
λ_m	most likely value of λ for the transformed data to be normally distributed
L_λ	likelihood function used in the Box-Cox test
$G_n(u)$	function used to estimate the mean and variance of log-normal data
p	probability of observing zero fish density
Z_i	transformed fish densities
M	sample size containing N nonzero values
\hat{F}_r	estimated mean for nonzero fish densities
\hat{V}_r	variance of estimated mean for nonzero fish densities

2.3 Definitions and assumptions

This section brings together the definitions and terminology used throughout the text. We derive the definitions from a comparison of terminology from McGraw-Hill Dictionary of scientific and technical terms (1989), Kendall and Buckland (1971), Sokal and Rohlf (1969) and Cochran (1977). Throughout this sub-section, we will introduce each specific term in capitals; following this, we will use it in normal type.

There are three general terms in use for describing estimates and associated errors. PRECISION refers to the way in which repeated observations conform to themselves. If a measurement is precise, repeating that measurement will yield a very similar result. If the measurement is imprecise, repeat measurement will give differing results. ACCURACY, however, refers to the closeness between the measurement and the true value. It may be possible to measure something very precisely, but arrive at an incorrect value. An accurate measurement is one that is close to the true value. Thirdly, we have the idea of an EFFICIENT estimate or estimation method. This term, attributed to Fisher (Kendall and Buckland, 1975), is not widely used in a formal sense, but is useful. It describes a method that provides estimates closer to the true value. Efficiency covers both methods for collecting and for analyzing data. A method is more efficient if an individual estimate is more likely to be close to the true value than for an alternative method. This concept of efficiency leads to two types of error. RANDOM errors may occur in either direction, but not necessarily equally, and can be reduced by further measurement - i.e. these are errors that contribute to precision and also to accuracy. BIAS or systematic error is error that may be in either direction but may not be reduced by increasing the number of measurements or observations. This is error that does not influence precision but does influence the accuracy of observations.

We need to introduce the idea of a POPULATION - i.e. the real distribution we are trying to measure. Usually the population is not the fish themselves but the true fish densities within the area we are surveying. In this case the population would be all the possible values of true fish density that occur within an area. This should not be confused with an ecological population or fish stock. To estimate this population, we will take several SAMPLES. These are measurements of the true population, acquired with some measurement error. They do not include a full set of the population values that exist - only a small sub-set. In acoustic surveys, the samples are integrals over depth of echo-intensity, averaged over many transmissions. Or they may be estimated numbers of fish counted over a period or distance. In either case, they are a measure of fish density. These samples have a value, which is defined as $y_1, y_2, y_3, \dots, y_n$ for n samples. The general sample is y_i where i can be any value from 1 to n .

The MEAN is defined as the integral of a function between two limits divided by the interval. This is the sometimes called the true mean, arithmetic mean or the mean of the population. It is important to distinguish it from the ESTIMATED MEAN, which is calculated from the n y_i samples as:-

$$\bar{y} = \sum_{i=1}^n y_i/n \quad (1)$$

The VARIANCE of the population is the second moment of a distribution taken about the mean and is given by:-

$$\sigma^2 = \sum_{i=1}^n (y_i - \bar{y})^2/n \quad (2)$$

The SAMPLE VARIANCE may be estimated as:-

$$s^2 = \sum_{i=1}^n (y_i - \bar{y})^2/(n-1) \quad (3)$$

This is a simple estimate of the population variance. More complex expressions for the variance will be found in later sections. This calculation assumes uncorrelated independent samples from a stationary population. We will define these three terms later. Even if these assumptions do not hold, the sample variance may be a useful measure of the variability of the samples. It may be used to compare results of two surveys carried out in the same manner. However, it should be remembered that sample variances from rather different styles of survey may not be directly comparable.

The STANDARD DEVIATION is a widely used measure of dispersion of the population. It is equal to the square root of the variance. The estimated standard deviation may be calculated as:-

$$s = \sqrt{s^2} \quad (4)$$

Both the variance and the standard deviation are properties of the population. The values of these are not influenced by the number of samples. With the exception that the precision of the values will be affected by the number of samples.

The COEFFICIENT OF VARIATION is often a more useful measure of dispersion. It is the standard deviation normalised by the mean:-

$$cv = s/\bar{y} \quad (5)$$

This measure is particularly useful in stock surveys where the standard deviation is often related to the mean.

The STANDARD ERROR is sometimes used interchangeably with the standard deviation, but it may be defined quite separately, as the standard deviation of an estimate of the mean. In this case it is dependent on the number of samples taken from the population and is defined as:-

$$se = s/\sqrt{(n)} \quad (6)$$

This is a very useful term, which is important to differentiate from the standard deviation of the population, which is independent of the number of samples n.

The MEAN SQUARED ERROR is also useful. This provides a measure of the total error in an estimate and is the sum of the variance and any biases squared.

These basic statistical terms and the simple formulas required to calculate them are the result of several assumptions. The different methods of analyzing data are usually the result of different assumptions about the data. We need to introduce a few more standard terms to describe the nature of the samples and their distributions.

We need to separate the ideas of SPATIAL and AMPLITUDE distributions. The spatial distribution describes how the population varies from one location to the next. The amplitude distribution describes the different densities that may be found in the population. There are several important types of distribution. The UNIFORM spatial distribution implies that the same amplitude distribution occurs at each point. A CONTAGIOUS spatial distribution is one that depends on a few probability distributions dependant on parameters that themselves have probability distributions. The implications of this are that the local mean density is different in different parts of the area. A way of describing these different spatial distributions is as a number of types of distribution in a continuum - i.e. the uniform distribution where the presence of a shoal tends to reduce the likelihood of a further shoal, through the poisson distribution where shoals occur randomly anywhere, to the contagious distributions (e.g. negative binomial) where the presence of a shoal increases the likelihood of another shoal.

The distribution of a random variable may be described by a PROBABILITY DENSITY FUNCTION (PDF) such as a Gaussian or normal distribution. An alternative term for this is the frequency function.

Samples are INDEPENDENT when the value of y_i is not influenced in any way by the values of y_{i+1} and y_{i-1} . The samples are said to be DEPENDENT if there is some dependence of y_i on y_{i-1} . Adjacent samples may influence one another for two different reasons. First the measuring device may be incapable of reacting to a new value, or error in the measurement at one point may be linked to error at the adjacent point. However, in acoustic surveys the echo sounder system is quite capable of responding to very sharp changes in fish density. There is no reason to believe that any large random effects except due to real spatial variation are the same for adjacent samples. A second possibility is that the spatial distribution of the stock is non-uniform and that there are regions with high and low density. In this case, the samples may not be independent due to the particular spatial distribution and the sequential method of data collection along a transect.

During a survey, the samples are collected along transects with successive samples obtained from consecutive sections of cruise track. Adjacent samples may be SERIALY CORRELATED if the population has some spatial structure. SERIAL CORRELATION is sometimes called auto-correlation. The presence of serial correlation has considerable impact on the estimate of variance and some impact on the survey design.

The CORRELATION COEFFICIENT at lag j may be calculated on any transect by:-

$$r_j = \frac{\sum_i y_i y_{i+j}}{\sqrt{\sum_i y_i^2 \sum_i y_{i+j}^2}} \quad (7)$$

The presence of correlation may be due to spatial structure within the survey area. The density in one part of the area may be much higher than in another. If this is the case, there is a possibility that the data may be NON-STATIONARY.

STATIONARITY is a term that relates specifically to a STOCHASTIC process. It describes random rather than deterministic processes. Often a stochastic process is one in which the randomness occurs in time - i.e. each estimate of a variable will take a value that varies randomly in time. However, sometimes the stochastic process may be random in space. Each point in space has a value and that value is the result of some random process, not a deterministic process. The density distribution of fish within an area may be considered a stochastic process. This stochastic process may be STATIONARY or NON-STATIONARY.

If a process is stationary, then for all realizations, the mean of the population and the variance of the population will be the same throughout the area. This does not mean that any one stock distribution is uniform. It may be contagious and there may be much higher densities in one part of the area than in others. If however, the high or low densities can occur anywhere within the area, on some years, or some occasions, then the process is stationary. If however, there are believed to be some parts of an area that will always yield lower densities (e.g. there appears to be a depth related stock density dependence), then the stock distribution may be said to be non-stationary. Stationarity should not be confused with MOBILITY, the physical movement of a stock in an area due to migration behaviour. The more mobile a stock is within an area the more likely the statistics are to be stationary. However, mobility does not imply stationarity.

We have used the idea of several REALIZATIONS. One realization is the spatial distribution of densities encountered given a fixed survey area, with fixed seabed contours and a fixed stock size surveyed on a particular date. The other realizations are all the other possible different spatial distributions that might occur due to the typical variation in weather, hydrography, fish behaviour and point in any biological calendar of development or migration. It is useful to consider the other possible realizations to understand the assumptions that are appropriate for survey design and data analysis. In the later sections, we will discuss how the different data processing methods make different assumptions about the samples and their distributions.

3 SURVEY DESIGN

Throughout the world, fisheries acoustics survey work varies widely in both scope and intent. When very little is known about the fishery resources in a particular area, the assessment scientist can employ acoustic techniques to delineate the range of pelagic stocks. Fisheries acoustics is an ideal distributional mapping tool for pelagic resources because of its ability to cover large areas in a short time relative to other assessment methods. For some assessment programs, the primary goals are to assess the fish distribution and to estimate stock abundance. For example, fisheries modellers may require relative abundance estimates (along with estimates of precision) to "tune" a cohort analysis model. On the other hand, fisheries managers may require estimates of absolute abundance to set quotas for the commercial fishing industry.

Shotton and Bazigos (1984) observed that acoustic surveys may vary widely in their geographical extent and the time period over which they occur. At one extreme are surveys which cover many decades of latitude, take

several months to complete, and are not replicated. At the other extreme are stock-defined surveys, executed when the stocks have a localized distribution which permits the entire population to be surveyed in less than a day, with stratification of sampling effort and replication within strata.

Critical to the success of any fisheries assessment program, an efficient survey design must incorporate all available knowledge of the stock in question. Increased survey effort is no substitute for a properly designed survey based on a thorough understanding of the biology of the target species and a clear definition of objectives. In general, fish tend to aggregate forming contagious distributions. The degree of contagion varies with, among other things, species and stock, time of year/day, distribution of food organisms, and environmental conditions. All this information should be considered when designing an acoustic assessment survey. If a priori information is not available, a series of pilot surveys covering extensive areas and different seasons may be necessary before an efficient quantitative survey can be reasonably well designed (Johannesson and Mitson, 1983).

The design of a survey to obtain an estimate of fish stock abundance should satisfy the requirements of sampling theory. Shotton and Bazigos (1984) noted that a sample design should - 1) generate estimates which have desirable statistical properties such as consistency and lack of bias, 2) allow objective evaluation of the precision of the sample results, and 3) allow comparison of the precision among different designs and allow comparison of modifications of the same design.

Survey design is necessarily linked to the analysis of the data collected. A poorly designed survey will preclude meaningful analysis. An optimal design will provide unbiased estimates of abundance with minimum variance. Any adopted survey design and method of analysis require that certain assumptions be satisfied. If these assumptions are not met, some idea of the robustness of the procedure is necessary. In other words, the researcher must be assured that deviations from these assumptions do not significantly alter results.

The precision of any survey will depend on - 1) the intrinsic variability of the fish population under study, 2) the number of sample units, and 3) the design of the survey and the method of analysis (Johannesson and Mitson, 1983). Methods of increasing the precision of an estimator always involve the sampling plan (Smith, 1990).

Survey design and analysis in the field of fisheries acoustics has been reviewed earlier in Shotton (1981), Shotton and Bazigos (1984), and Johannesson and Mitson (1983). Our discussion of survey design will focus on the following items - 1) defining the survey area, 2) choosing a trackline, 3) methods of biological sampling, 4) balancing acoustic sampling with biological sampling to determine track length, and 5) choosing a sampling unit.

3.1 Definition of survey area

In designing a survey, the availability of the target species to acoustic assessment techniques must be clearly understood (Traynor et al, 1987). One must consider this question of availability in both time and space. Ideally, the assessment scientist wishes to survey the entire stock isolated in a localized area for a specified period of time with little or no immigration or emigration. Suomala and Yudanov (1980) cite the following conditions as optimal for acoustic surveying - calm wind and seas, single species of fish of uniform size and stable behaviour, and distribution of fish in a continuous layer of uniform density, away from the surface and the bottom. This ideal is rarely achieved but, in some situations, may be approximated with proper planning.

Consider first the timing of an acoustic survey. For example, at certain times of the year, the stock may undergo migration to a spawning area or feeding grounds. This migration period is an inopportune time to survey. However, if once the fish reach the spawning area or feeding ground, there is a window of time of relative stability, this may provide an opportunity for an acoustic "snapshot" of the resource. A fish stock

aggregated on a feeding ground requires much less vessel time to survey than one dispersed over a much larger survey area. It also avoids the potential thresholding problem presented by low densities of the target species spread out over a larger survey area.

At certain times, portions of the stock may move inshore to depths inaccessible to the acoustic survey vessel. Or perhaps, the waters are still deep enough to allow the vessel to operate, only now a problem with vessel avoidance occurs. Jakobsson (1983) observed this type of behaviour with Icelandic herring at night and adjusted his survey time to avoid it. For some target species, there is significant diel vertical migration. At one time of day, fish are distributed near the sea bed; whereas later they are found near the surface above the depth where they can be effectively surveyed. Both of these situations pose potential problems for acoustic assessment and may require restricting survey work to only daylight or only nighttime hours. Referring again to Jakobsson (1983), Icelandic scientists found that, during the day, herring distributed very close to the sea bed and were difficult to assess acoustically. Faced with a seemingly impossible situation, they were able to find a window of time in the early morning hours when the herring had moved offshore and had not yet descended to the bottom. Their survey work was conducted during this window.

A critical part of acoustic assessment is the identification of echo trace, usually accomplished with trawl sampling. This task is made much simpler if the target species is not mixed with other fish species. Certain seasons and/or times of the day may be selected for surveying to avoid or minimize this mixing. Consider, for example, the Pacific whiting (*Merluccius productus*) surveys conducted by U.S. scientists off the west coast of the U.S. (Dark et al, 1980). During the night, whiting aggregations disperse and mix with rockfish and other species making them difficult to assess. To avoid this situation, survey work is conducted only during daylight hours. Finally, from a more mundane perspective, the influence of Mother Nature on survey plans cannot be overlooked. For example, winter storms in the Bering Sea or Baltic Sea have usurped many vessel days.

Once an appropriate survey time has been chosen, the geographical limits of the survey area must be defined. All available sources should be consulted when attempting to define a survey area - e.g. commercial fishery catch statistics, results of past surveys, relationships with environmental variables or bathymetric parameters, etc. Observed correlation between fish distribution and environmental and/or bathymetric parameters should be exploited. The choice of area to be surveyed is often based on one or a combination of the following factors - 1) national boundaries (e.g. US/USSR Convention Line in the Bering Sea, ICES management areas), 2) physical boundaries (e.g. coastline, lake shore), 3) the suspected range of the target species (e.g. on-shelf, off-shelf), and 4) oceanographic conditions (e.g. sea ice, ocean currents). Occasionally, acoustic research vessels may be limited by bottom depth - especially if employing a towed body system. Fish distribution may continue inshore to shallow waters unsafe for the vessel to follow.

In some situations, there may be no discrete boundaries to the distribution of the fish stock. It is important that acoustic surveys extend to areas of low or zero concentrations or otherwise bound the distribution (Conan, 1990). However, sometimes a compromise must be made between biasing the population estimate by ignoring those undefined low-density areas and directing the sampling effort to improve the precision of the estimate for the areas of major abundance (Shotton, 1981). A more detailed discussion of this question will be presented in the adaptive sampling section 3.2.2. Additionally in low density areas, species identification may be less certain, and noise may have more of an effect.

Armed with an understanding of the biology of the target species along with the knowledge of the anticipated stock spatial structure and dynamics at survey time, the assessment scientist is still limited by available resources (i.e. vessel days). This is the bottom line. There is a window of time within which he/she must conduct the survey. This window must allow for vessel loading and unloading, transit to and from the survey area, weather days, in port periods, trawl sampling, and oceanographic/hydrographic data collection. The survey planner can be likened to a juggler, balancing all components to arrive at a workable scenario. Most often, the critical phase of this balancing act is the allocation of resources between acoustic sampling and biological sampling. At this

point, a thorough understanding of the biology and distribution of the target species proves invaluable. If the stock spatial structure is such that the fish are relatively evenly dispersed through the survey area, but the species/size composition is quite variable, emphasis should be placed on trawl sampling to identify echo trace and estimate size composition for target strength scaling. If, on the other hand, biological characteristics are rather uniform, but the geographic distribution is contagious, the balance tips in favour of more acoustic sampling.

All prior discussion has assumed that there is only one target species of interest. If the survey goal is to assess the distribution and abundance of two or more species, the challenge presented to the survey planner is far more complex. The questions of survey timing and range must now be addressed for two (or more) populations. It is as if our juggler must now perform his/her balancing act in an additional dimension. Prioritizing research needs for each target species is a first step to solving this problem.

3.1.1 Stratification

In introduction to the process of stratification, we revisit the concept of stationarity. This characteristic of a finite population must be examined in both time and space. In statistics, a random variable Y is stationary if all observations y_i come from the same probability distribution (or in a weaker sense, all have expectation μ). In the case of fisheries acoustics surveys, this implies a constant mean abundance μ over the surveyed area during the time of the survey period.

The following text is paraphrased from Shotton & Bazigos (1984). "Stratification is the process whereby a survey area is divided into subareas or strata. In sampling theory, an area is stratified in an attempt to reduce the variance for a population estimate. If strata are chosen properly, observations within strata will be more homogeneous than if considered sampled over the total survey area. Stratification is in part an attempt to ensure stationarity of the density variable within a stratum. Stratification of the survey area may be a sensible design even without prior knowledge of the variability of the fish distribution throughout the survey area. By dividing the total area into several strata, and using a randomized design within each stratum, the sampling transects will be more evenly distributed. A valid estimate of the variance can still be obtained and the danger of a large error is reduced, in the event a major part of the fish population is located in an area which is lightly sampled."

Suppose that a survey area A is divided into h strata - each of area A_h with sampling effort n_h . Suppose also that the estimates of mean density and variance for stratum h are \bar{y}_h and s_h^2 , respectively (see equations 1 and 3). Then from Cochran (1977), the estimate of mean density for the total area A is:-

$$\bar{y}_{st} = \sum_h (A_h \bar{y}_h) / A \quad (8)$$

and its variance estimate is:-

$$var(\bar{y}_{st}) = \sum_h (A_h^2 s_h^2 / n_h) / A^2 \quad (9)$$

In a stratified survey area, if the amount of sampling within a given stratum is dictated by the size of the stratum, this is called 'proportional allocation' - i.e. n_h/A_h is constant for all strata. Intuitively we know that the precision of an abundance estimator will depend on the degree of sampling coverage and the homogeneity of the fish distribution.

Therefore, if a priori information about the variability within strata is available, a more appropriate procedure is to assign more sampling to those subareas of higher variability in an attempt to increase overall precision.

This assignment is called 'optimal allocation' (Neyman, 1934).

$$n_h = nA_h s_h / \sum_h (A_h s_h) \quad \text{where } n = \sum_h n_h \quad (10)$$

In practice, when stratum variances are unknown, an assumption is made that stratum variance is proportional to stratum density. In effect, areas of higher density are allocated more sampling.

Many types of survey stratification are encountered in the fisheries acoustics literature. Historical catch and/or survey data provide the assessment scientist with a priori information to identify high fish density areas. Often, a target species is known to prefer certain environmental/bathymetric conditions over others. This information can be exploited to allocate sampling based on correlated ancillary variables (e.g. bottom depth). Stratification may be based simply on administratively-defined blocks as with the ICES statistical rectangles. We consider a few representative examples and comment on them accordingly.

1) Shotton and Dowd (1975) present a form of stratification they call the 'method of parallelograms' (Figure 1). The survey area is approximated by a set of parallelograms. One or more transects are allocated to a parallelogram with transect length proportional to the area of the parallelogram. Some transects traverse from one side of the quad to the opposite side in a straight line (e.g. quads 1,2,3). Whereas, for quad 4, to maintain a constant ratio of transect length to quad area, the transect undergoes a course change in traversing from one side to the other. For quads 1, 2, and 3, the transect can be considered a random sample of size 1 from a finite population of transects in the respective quad. For quad 4, the situation is not so simple because the method of constructing the angled transect does not define a finite population of angled transects that completely cover the area of quad 4 without overlap.

2) In Kirkegaard et al (1990) and Simmonds (1989), Simmonds describes the survey methodology employed in assessing North Sea herring (*Clupea harengus*) during the summer months. The survey area is divided into what are termed 'statistical rectangles' - 15 minutes of latitude by 30 minutes of longitude (Figure 2). For analysis purposes, these rectangles are assumed to be areas of homogeneous fish distribution. At least one transect must pass through each statistical rectangle. Based on previous survey results, two levels of sampling were imposed on the survey grid of statistical rectangles. For areas of high fish density, two transects were allocated to each unit area; for areas of low density (e.g. south of 57°45' N), a single transect was used (Figure 3). This is an example of optimal allocation in stratifying the survey area. Note that allocation of transect lines to statistical rectangles is not performed individually for each rectangle. A random position is selected for the group of unit areas in an east-west orientation. In analyzing these data, an abundance estimate and variance is calculated for each statistical rectangle. A detailed explanation of the method of analysis is presented in section 4.5.1.6 on transform methods.

3) Jolly and Hampton (1990) provide one of the few detailed explanations of the use of stratification in survey design in the fisheries acoustics literature. They recommend the use of a stratified random transect design for acoustic surveys. This type of survey design was used to assess the spawning biomass of anchovy (*Engraulis capensis*) off the coast of South Africa in November 1985. Density information from the previous year's survey was used to stratify and then allocate sampling in the different strata. Three general areas of abundance (A-zero, B-high, and C-low) were observed in 1984 (Figure 4). For the 1985 survey, the high density area B was further divided into an inshore and offshore region as well as east and west of Cape Agulhas. Comparison of Figures 4 and 5 show that the broad-scale distribution of anchovy in 1984 and 1985 was similar, justifying the use of the 1984 density structure in the design of the 1985 survey.

Table 1 compares the standard errors that would be expected on the basis of the 1985 results from a sample of 34 transects allocated to the five strata in the following ways:

- (a) at random, ignoring strata,
- (b) stratified with a uniform sampling fraction - i.e. proportional allocation,
- (c) stratified with optimal allocation using the stratum variances from the 1985 survey, and
- (d) stratified with the actual allocation used in 1985.

Table 1. Standard errors in mean density (g/m^2) expected from different allocations of sampling effort in the 1985 survey (from Jolly and Hampton 1990).

Stratum	Unstratified	Stratified (numbers of transects in brackets)		
	(a)	(b) Uniform	(c) Optimal	(d) Actual
A		8.51 (8)	5.52 (19)	8.02 (9)
B		3.16 (9)	3.00 (10)	3.00 (10)
C	Total of 34	0.64 (6)	1.57 (1)	0.79 (5)
D	transects	1.96 (5)	2.53 (3)	1.79 (6)
E		0.48 (6)	1.18 (1)	0.59 (4)
var(\bar{y}_{st})	5.76	2.37	1.69	2.22
cv(\bar{y}_{st})	0.26	0.17	0.14	0.16

Note that the variance in the unstratified sample is more than twice that of a stratified sample. This result clearly demonstrates the rewards inherent in proper stratification of the survey area. The gain in precision with different allocation schemes is not as evident in these data. Coefficients of variation for the uniform, optimal, and actual allocations are not all that different.

4) Some authors (e.g. Degnbol and Kirkegaard in Kirkegaard et al, 1990; Stæhr and Neudecker, 1990) provide descriptions of stratifying the survey area by depth using previous results that show biological differences for different bottom depth regions. Inspection of the cruise trackline does not reveal transect allocation related to depth regions. It must be assumed that this stratification by depth takes place during analysis of the data. If so, this is more accurately referred to as a form of 'post-stratification'. This topic will be discussed in more detail in section 4.2

3.2 Track design

In the following discussion, the terms 'track' and 'trackline' will be used interchangeably to refer to the collection of 'transects' (i.e. straight line segments) that make up a survey.

Once a survey area and time have been chosen, a track design must be selected. If the survey area has been stratified in an effort to increase precision, an independent track design must be chosen for each stratum. Examples of track design are quite numerous in the literature (see Shotton, 1981). In practice, the trackline is often fit to the population under study. Most common in the literature, are zig-zag (triangular) (Figure 6a) and parallel (rectangular) (Figure 6b,c) track designs. These patterns may be allocated randomly over the survey area or in some systematic fashion. Each approach possesses its own advantages and disadvantages. Sometimes one laboratory may employ different types of design for different surveys. For example, U.S. scientists used a zig-zag track to survey Pacific whiting along the narrow shelf off the west coast of the U.S. (Dark et al, 1980), and a parallel track to survey walleye pollock (*Theragra chalcogramma*) in the extensive shelf waters of the eastern Bering Sea (Traynor et al, 1990). There have been many attempts in the literature to show one approach to be preferred over the other - sometimes with real data and sometimes with simulated data. These comparisons will

be presented and commented on later. First, we discuss the differences between random and systematic sampling. An important point to keep in mind throughout the ensuing discussion is that the choice of trackline design is statistically coupled with the proposed method of analysis.

Another distinction to make among track designs is that some follow a predetermined or fixed pattern while others are more adaptive -i.e. allowing for change within the survey time period. These adaptive schemes include outline surveys, extension or early termination of predetermined transects, and widening or narrowing of transect spacing. In practice, one often finds that a fixed trackline pattern must be altered during the survey to respond to what is observed. A discussion of predetermined track designs will be presented first followed by an investigation of adaptive designs.

3.2.1 Predetermined track designs

3.2.1.1 Direction

If no information is available about the migratory behaviour or spatial structure of the fish stock, the transects should be chosen to cross the shortest axis in order to minimize the time interval spent travelling between them (Simmonds, 1989). This choice is purely logistical. In statistics, a random variable is termed 'isotropic' if it exhibits the same covariance structure in all directions. If the covariance structure is not the same in all directions, it is termed 'anisotropic'. In an anisotropic situation, the direction of transects is chosen with the aim of minimizing variance among transects. (Prevailing winds and weather must also be considered.) In practice, fish are often distributed displaying some preference for bottom depth regions. So the greatest variation in density is expected along transects oriented perpendicular to bottom depth isolines or contours.

Alternatively, if the stock has a known migratory direction, it is best to survey along the line of migration so that alternate transects go with and then against the direction of fish movement (Simmonds, 1989) in an attempt to average out the effects of migration. This subject is dealt with more fully in section 4.5.3.1. Simmonds (1989) suggests that if the population of interest displays both a bathymetric preference and migratory behaviour that the first of these conditions should take precedence over the latter in designing the survey. For example, if a fish stock shows an inshore-offshore density gradient along with general movement along the coastline, the appropriate choice of transect direction is to place the transects normal to the shoreline to address the condition of anisotropy.

Kizner et al (1982), via computer simulation, investigated the impact of stock movement on the "reconstruction of the statistical image of a density field". Given the situation described above with transect lines normal to the shoreline and fish moving along the coast, the result of surveying either with or against the direction of stock movement is likened to the Doppler shift effect in the physical sciences. If the general survey direction coincides with the direction of stock movement, the observed distances between aggregations will be longer than in actuality and the aggregations themselves will appear stretched. If the direction of survey is against the direction of movement, the distance between aggregations will appear shorter and the aggregations will be contracted. Any biases resulting from stock movement will depend on the relationship of vessel speed to fish stock migration speed.

3.2.1.2 Systematic vs. random sampling

To distinguish between systematic sampling and random sampling, we consider a finite population of N unique and identifiable units. A random sampling procedure ensures that each of these units has an equal probability of being chosen. However, for a systematic sample of size $n = N/k$, the first element is chosen at random from among the first k units, and then every k th unit is selected thereafter. In an acoustic survey, the sampling unit or element might be the region ensonified along a single transect. In two dimensions, this is a strip of area with a width described by the equivalent beam angle of the transducer and the depth of the water column and a length

equal to the length of the transect. For most practical survey situations, $N \gg n$.

For a grid of parallel transects, a systematic sample would result in equally-spaced transects - i.e the distance between transects is constant (Figure 6b). For a random sample of parallel transects, the starting (ending) point of each transect is chosen at random along the side perpendicular to the direction of the individual transects (Figure 6c). For a grid of zig-zag transects, a systematic sample is attained when the distance between endpoints on the same side of the survey area is constant for both sides (Figure 6a). Shotton and Bazigos (1984) describe another type of survey design which is neither random nor systematic sampling. This type of sampling, termed purposive or haphazard, is illustrated in Figure 6d. A purposive sampling design, though useful in mapping fish distribution, is inappropriate for abundance estimation and will not be discussed further.

3.2.1.3 Systematic zig-zag

Proponents of a systematic zig-zag track design cite a more efficient use of track time as the reason to choose a zig-zag grid over a parallel one. For a parallel grid with transects extending to the fish distribution boundary (or beyond), the time spent travelling from one transect to the next is "wasted". Simmonds (1989) observed that survey questionnaire respondents tended to use systematic parallel transects when the transect length was long relative to the inter-transect spacing. When transects were short or needed to go close to shore, a zig-zag track was chosen. For example, a zig-zag grid would be selected for a narrow coastline shelf or fjord and a parallel grid for larger survey areas. Arguments in support of a zig-zag trackline appear to be more geometric or logistic than statistical.

Two important limitations of a zig-zag trackline pattern are 1) the non-independence of transect segments and 2) a higher sampling intensity per unit area at the turns compared with other portions of the track. Proponents of zig-zag tracklines suggest that these limitations can be addressed by using a "zig-zag/parallel hybrid" -i.e. at the end of one transect, the vessel steams a pre-determined distance before starting the next transect of the zig-zag grid. Jolly and Hampton (1990) note that the advantage of parallelism to remove variation from density gradients in the direction of the transects is lost with a zig-zag design.

3.2.1.4 Systematic parallel

Shotton and Bazigos (1984) offer the following comments on systematic sampling ... "If properly applied, the position of the first transect should be randomized. If a transect is considered to be one observation, then systematic sampling is equivalent to stratifying the population into n strata with one observation per stratum. Note, however, that this observation is not randomized within strata. If the distribution of the population shows no trend in density from one region to another, then systematic sampling should be essentially equivalent to simple random sampling. And if there is a linear trend in the direction of sampling, the variance for a systematic sample will be less than the variance for a random sample." Cochran (1977) notes that some sampling surveys carry the notion of systematic sampling one step further by removing the requirement of a random starting point. This practice is quite common in fisheries acoustics survey work. The survey starting point is selected at a predetermined distance from the survey area boundary - e.g. half the trackline spacing distance. Proponents of systematic sampling stress the importance of uniform sampling throughout the survey area. Detractors remind us that, statistically, there is no valid (i.e. unbiased or consistent) estimator of variance from a systematic sample, unless the population is randomly distributed. Proponents counter that, for some fish stocks, the distribution of fish densities can be assumed to be randomized with respect to the placement of equally-spaced transects. Under this assumption, estimation of variance is possible. Finally, detractors note that estimation bias will exist if the population densities appear periodic and synchronized with the transect spacing - an unlikely situation in the real world.

3.2.1.5 Stratified random parallel

Proponents of random sampling point out that this type of sampling satisfies the requirements of classical sampling theory. A random sampling survey design also provides unbiased estimators of the mean and its variance. Detractors contend that the random element involved in positioning transects may leave large portions of the area unsurveyed or else two transects very close to each other. Jolly and Hampton (1990) concede this point and offer a compromise between regular spacing and complete randomization. They propose a 2-stage sampling design. The stratum is first divided into strips of equal width. Strips are chosen at random as part of the first stage of sampling, and then one transect is chosen at random within the strip completing the second stage of sampling. For the 1985 South Africa anchovy survey (referred to earlier in section 3.1.1), the width of a strip was chosen to give an anticipated first stage sampling fraction of about 0.3. For example, if resources permit 3 transects to be surveyed in stratum Q, then the area of stratum Q will be divided into 10 areal strips. There still remains a chance that two transects will lie very close to each other and possibly be surveying the same fish. To prevent this, a rule was made to discard any transect lying within a specified distance of a previously selected strip. For this survey, that distance was one strip width. The authors believe that this restriction "will have negligible effect on theoretical considerations".

3.2.1.6 Cross-transects

For a parallel track design, a portion of the track mileage is spent travelling from the end of one transect to the start of the next. This inter-transect segment will be referred to as the 'cross-transect'. Positioning this cross-transect within or beyond the anticipated fish distribution is dependent on the method of data analysis selected. Some survey planners would argue that extending each transect beyond the observed fish distribution is required to ensure that no fish are encountered while travelling between transects. Others contend that this practice is wasteful and prefer to position the cross-transect within the anticipated fish distribution to allow the data collected to be incorporated in the analysis. Simmonds (ms) offers the following approach. The cross-transect is positioned at a distance from the survey area boundary equal to one-half the inter-transect spacing. This procedure ensures that on average the same sampling intensity is obtained in the middle and at the edges of the survey area. If the parallel transects are placed randomly within the survey area, then the resulting cross-transects will also be randomly positioned. Simmonds (ms) allows that, under some circumstances, it is essential to continue the transect to the edge of the survey area. For example, at a survey boundary where the fish density gradient is expected to be sharp, it is best to transect through the gradient to the survey boundary and then omit the cross-transect data from the analysis.

3.2.1.7 Discussion

Many authors have addressed the question of track design in fisheries acoustic surveys. A few, either theoretically or empirically with simulated data, have attempted to compare the different designs in hopes of being able to show one approach superior to the others. Results from these comparisons depend strongly on the authors' assumptions.

One of the first papers to present simulation results for a comparison of survey tracks was from Nickerson and Dowd (1977). In their manuscript, the zig-zag pattern was found to be optimal based on the criterion of minimizing the confidence interval of the mean estimate for a given length of survey. The applicability of their results is contingent on the suitability of their variance estimator. In this case, a variance estimator from Hogg and Craig (1968) was used. This estimator corrects the random sample variance estimator with an autocorrelation term. Further comment is not possible because the simulation results are not explicitly presented in paper.

Vorobyov (1983) examines the question of track design with respect to searching theory. He models the acoustic survey as a stationary Poisson process - i.e. a flow of detected fish aggregations. He presents a geometric argument showing that a zig-zag track "observes" more area for a given time period t_e than does a

parallel grid. Hence the detection potential is greater with a zig-zag design. However, examination of the formulae involved in the comparison reveal that the distance travelled along a zig-zag track during time period t_c is greater than the corresponding distance travelled along a parallel track. This would imply different vessel speeds for the two tracks and thus would bias the results of the comparison.

In what is probably the most often referred to piece of work on the subject, Kimura and Lemberg (1981) compare variance estimates from zig-zag sampling, systematic parallel sampling, and random parallel sampling. The parameter of investigation in their simulation study is the length of trackline intercepted by fish schools. The mean and variance of this parameter is estimated for the three track designs under different sampling intensities and different school configurations varying school size, school density, and survey area shape. Results indicate that a zig-zag design is superior when sampling intensity is low (i.e. small number of transects in the survey area), and when sampling intensity is high, a systematic parallel track is preferred. The authors present their results in this way. For low sampling intensities, the length of zigzag traverses is greater than the length of an equal number of parallel traverses. (This is, in effect, a geometric argument.) For high sampling intensities, the systematic parallel track is superior (in spite of the above argument) because parallel sampling is more uniform along the boundaries of the survey area. (This reasoning refers to the unequal sampling intensity present at the turns of a zig-zag track.) Both zig-zag and systematic parallel sampling were uniformly more efficient than random parallel sampling. It is important to note here that this study, though complete, may be of limited applicability. The authors consider only the component of variation due to the configuration or distribution of circular non-overlapping, equal-sized, equal-density schools randomly located in the survey area. Within-school variation is not examined. It is not known how deviations from this ideal would affect their results.

Francis (1984) in a response to Kimura and Lemberg (1981) offers the following explanation for their results. "Patchiness in fish distributions implies that fish densities at two points close together are positively correlated. The variance of a density estimate will thus have a contribution from this correlation. In the above-mentioned study, random parallel transects perform poorly because they allow the possibility of adjacent traverses being close and thus highly correlated. Systematic parallel tracks minimize intertraverse correlations by maximizing the distance between traverses. With zig-zag tracks, there will be high intertraverse correlations at the vertices (or turns)."

In 1989 and 1990, ICES convened a study group to investigate the applicability of spatial statistics to acoustic survey data (Conan and Stolyarenko, 1989; Conan, 1990). Spatial statistical techniques involve estimation of a variogram to describe the covariance structure over the survey area. Conan and Wade (Conan 1990) comment that a grid coverage allowing variogram estimates in all directions is preferred. In the particular case of narrow fjords, the 1990 Spatial Statistics Working Group deemed it essential that the survey provide information across the fjord as well as along the length of the fjord. The 1989 Spatial Statistics study group formed the following conclusions ... "No consensus was met on the opportunity to substitute regular grid sampling to random or stratified random sampling for the global assessment of a resource. (However,) when preliminary surveying is not feasible, or when other particular prior knowledge about the stock's distribution is not available, the acoustic sampling could be satisfactorily done along parallel, equally-spaced line transects. In general, the transects should be crossing with the maximum density gradient."

As is evident from the preceding discussion, no single strategy is optimal for all survey situation, and the choice of track design is inherently linked with the proposed method of analysis. Knowledge of the distributional characteristics of the stock and the physical area to be surveyed must be considered in choosing a track design. Consider first, a "narrow" geographic area to be surveyed (e.g. fjord, narrow off-shelf region) with significant density gradient along the short axis of the region. For this type of spatial distribution and area, a zig-zag track design may be the most appropriate. However, survey planners must exercise caution when using this type of design because of the increased, and thus uneven, sampling intensity at the vertices (or turns) of the grid. This poses a major problem if, for example, high densities are found at the boundaries of the survey area. If the zig-zag track is extended such that the vertices (or turns) are extended beyond the boundaries of the fish distribution,

the unequal sampling problem is alleviated. In an open sea or "wide" shelf survey situation, a grid of parallel transects is recommended. Parallel transects can be utilized to eliminate the component of variance in one direction. If, from past survey work, the stock is characterized by smooth large scale changes in spatial distribution, the optimal survey strategy may be a systematic grid of equally-spaced transects. If the stock exhibits a highly contagious spatial distribution and can be considered to be random with respect to the transect spacing, a systematic grid of equally-spaced transects is optimum. If there is reason to believe the stock is not randomly distributed with respect to transect spacing, we recommend the two-stage sampling procedure discussed in section 3.2.1.5. A fully random sampling scheme which could possibly leave large portions of the survey area unassessed is not recommended under any circumstances. Recommended track designs for different survey areas and stock distributions are presented in Table 2.

Table 2. recommended track designs for different survey areas and stock distributions.

Survey Area	Stock Distribution	Track Design
Narrow Shelf / Fjord	Low Contagion ¹	Systematic Zig-zag ²
	High Contagion ¹	Systematic Zig-zag ²
	Non-stationary ¹	Systematic Zig-zag ² (with stratification)
	Very High Contagion ¹	Outline followed by Systematic Zig-zag ²
Wide Shelf / Open Sea	Low Contagion ¹	Systematic Parallel
	High Contagion ¹	Systematic Parallel
	High Contagion ³	2-Stage Random Parallel
	Non-stationary ¹	Systematic Parallel (with stratification)
	Very High Contagion ¹	Outline followed by Systematic Parallel or Adaptive (spacing or lengths)

Notes

- 1 Stock distribution is assumed random with respect to transect locations.
- 2 Zig-zag designs must be used with caution (see section 3.2.1.7 in text).
- 3 Stock distribution is assumed non-random with respect to a regular grid.

3.2.2 Adaptive track designs

So far we have considered only the pre-planned survey in which the cruise track is decided on the basis of prior decisions. All adaptive survey strategies require some knowledge of fish distribution. The decisions required for the adaptive approach cannot be made in the absence of a knowledge of the spatial distribution. There are circumstances in which it might be desirable to adjust the cruise track as the work proceeds (e.g. if it is important to locate commercially exploitable fish concentrations. It may be decided that areas of high density should be surveyed more intensively than elsewhere. However, the adaptive survey is not necessarily appropriate when the principle objective is to determine the stock abundance. The problem is that the acoustic data may not be considered as entirely random samples because the position at which each measurement is made has been determined to some extent by the earlier observations, and the abundance estimate may be biased. In addition, it will almost certainly be very difficult to estimate the confidence limits from such strategies. It is not easy to allow for the bias in the analysis, and whether this can be done at all depends upon assumptions about the fish distribution which may be difficult to validate. It is very important to obey strict procedures in the execution of adaptive surveys and to use only appropriate analysis methods for estimation of biomass.

We shall consider three kinds of adaptive survey. One technique is to begin with an outline survey which is a rapid investigation of a large area using widely-spaced transects. This is followed by more intensive examination of particular regions where fish concentrations have been detected. Another approach is to fix the transect spacing in advance, but to allow the length of the legs to be changed during the survey. Thirdly, the transect lengths may be decided beforehand while the spacing is varied according to the observations made at the time.

There are two important considerations to be borne in mind when making the real-time decisions required during an adaptive survey. Firstly, when the sampling intensity is reduced, the coverage must still be sufficient to provide good enough information to decide the subsequent sampling strategy. Secondly, when the plan is to return to regions where large fish concentrations have been observed, success depends upon the assumption that the fish distribution does not change with time, so that the concentrations can be relocated without difficulty.

3.2.2.1 Outline survey

The survey is conducted in two stages. First, the vessel covers the area of interest on a widely spaced grid, to detect regions of high fish density. This stage should occupy no more than say 25% of the time available. The vessel then returns to the regions where fish have been observed, and the remainder of the time is spent in surveying these regions more intensively (Figure 7). This technique is not useful if the fish are likely to migrate or disperse in the time between the initial sweep of the area and the return visit. Furthermore, if the initial sweep is too widely spaced, some localized concentrations may not be detected at all. The outline survey works best when the area to be examined is not too large (e.g. within a fjord), and the fish are believed to be concentrated in a few large and static schools. The same technique has also been employed in tropical areas by Strømme and Sætersdal (1990). All fish stocks show some evidence of temporal change and the use of an outline survey with mapping methods such as geostatistics can cause problems if both outline and high density surveys are combined. The outline survey is best used for abundance measurements when a stock occupies a small proportion of the possible area.

3.2.2.2 Variable transect length

This technique may be applied when the spatial distribution is well defined in one direction. For example, suppose there is a coastline along one edge of the area to be surveyed, and the stock is located mainly in the shallow water near the coast. The survey is designed initially as a grid of transects running between turning points on the inshore and off-shore boundaries. During each run in the off-shore direction, it may be decided to terminate the transect once the observed fish density has declined to a small proportion of that observed near the coast (Figure 8). The acoustic data may be analysed in the normal way, by calculating the abundance in elements of area, on the assumption that negligible quantities of fish would have been observed along the abandoned parts of the cruise track. To facilitate the analysis, once the decision to turn has been taken, the transect should nevertheless be continued to the edge of the current area element that will be used for data analysis such as a rectangle or depth stratum.

3.2.2.3 Variable transect spacing

Suppose that the fish are expected to occur in local aggregations, but in regions which are unknown in advance (e.g. clusters of migrating schools). The general plan is to increase the sampling of any region where the observed fish density is much higher than the average, by reducing the transect spacing (Figure 9). The transects continue to run for the full length to avoid gaps in the coverage.

The transect spacing should be decided on the basis of objective criteria. The variance of the density measurements might be used to determine the spacing, as proposed by Stolyrenko (1988), on the grounds that precision is improved by sampling more intensively in regions of high variance. A simpler alternative technique

is to observe the mean fish density along each transect, and to make the spacing to the next transect proportional to $1/(\text{mean density})$ subject to the calculated spacing being contained within practical limits. When few fish are observed, the variance is also small and the effect is to increase the coverage of the main concentrations. The two methods may not be much different in practice. Jolly and Hampton (1990) found little difference in the two methods when analyzing data from a complete survey to give predetermined strata. Aglen (1989) analyzed data from a number of surveys using a coefficient of variation and obtained consistent results that suggest that the standard deviation of the population is proportional to the mean of the fish density.

Another approach is to design the survey grid in advance with a fixed transect spacing, but ensuring that the pre-planned track does not require all the time available for the survey. The spare time is used to cover extra transects in regions of high density. Whenever the observed density exceeds some limit, one extra transect is traversed half way between those of the pre-planned grid, so that the sampling intensity in that region is doubled. These techniques may cause bias. As the sampling strategy changes, transects are no longer placed evenly throughout the area but are concentrated towards the centre of the aggregation giving the possibility of bias unless the area allocated to each transect is chosen carefully. If this technique is used along with conventional processing methods such as those described in sections 4.2.2-6, bias may occur. The bias in the estimate of the mean density may be removed by randomizing the transect spacings.

We begin with a pre-planned set of parallel transects placed systematically or randomly in one or more strata leaving some extra time for transects to be inserted during the survey. When it is decided to increase sampling intensity, a new transect is included in the current strata and those ahead. This transect must be located randomly because all previously selected locations will have already been occupied by transects; thus no 'systematic' location for an extra transect exists. At this point in the survey, a trend has been found thus requiring increased coverage and indicating that the random relationship between systematic transect position and stock no longer holds and care must be taken to ensure that additional transects do not cause bias in the results. This procedure may result in the first additional transect being out of the normal sequence. On average, half the time, the track progression will reverse to run the extra transect. However, all the transects in each subsequent zone may be taken in the normal progressive sequence. When it is decided to reduce the sampling intensity, all the transects placed in the current zone must be completed first. Alternatively, the transects within each zone may be taken in random order - in which case the sampling intensity may be reduced at any time. Both these procedures are free of bias provided that strata with different sampling intensities are treated as separate regions in the analysis. Figure 10 illustrates the randomized adaptive method. The survey initially progresses from east to west. When the fish concentration is observed on transect 3, the sampling intensity is increased. By chance, transect 4 is back to the east, but the later transects are taken in the normal sequence. The method may appear complicated at first sight, but it is simple to implement in practice and provides an estimate of the abundance with minimal bias and without the need for doubtful assumptions about the spatial distribution of the stock.

The adaptive methods discussed above all suffer from the problem of possible bias in the estimates of abundance. If the assumptions required by the adaptive process are incorrect, bias will occur. Both the pilot survey and the adaptive transect lengths may miss some parts of the stock. The increased sampling may lead to more precise estimates of the parts of the stock that have been detected, while underestimating the total. In all cases, because the transects are located with reference to the observed fish densities, estimates of confidence limits may be difficult to calculate.

3.2.2.4 Summary

Adaptive techniques should not be used where the stock is mobile and can move significantly during the survey. Adaptive track designs are only recommended for surveys of highly contagious stocks (Table 2). By choosing an adaptive strategy, it must be accepted that estimating the precision of the survey cannot be attempted without further important assumptions about the stock distribution. If, following the data collection, it is uncertain whether the criteria required for the adaptive design have been met, such as the absence of

migration, great care must be taken in the analysis. Where double coverage has been used, it may be possible to use the data as two separate estimates.

3.3 Biological sampling

It is important to remember that acoustics and its application are a just tools to help with the assessment of fish stocks. Thus the acoustic data has no meaning if it cannot be related to the biological parameters of the observed population, particularly if it cannot be proportionally allocated to each species, and ideally to each length or age class of the different species. Biological sampling is obligatory. Moreover, there are relationships between the biological characteristics (species, length, physiology, etc.) of a fish and the reflected echo. For this reason too, biological sampling is required.

3.3.1 General

In most cases, biological sampling is performed during the acoustic survey by a single vessel. It consists principally of fishing operations. This method induces high perturbations in the acoustic sampling scheme, and in some cases may look incompatible with a structured sampling design. Acoustic sampling must follow certain constraints (e.g. grid, transects, distance inter transects, etc.) in order to obtain the best estimates. Biological sampling is performed on stations or effectively at points; acoustic sampling is continuous. Biological sampling depends on the presence and catchability of the fish; acoustic sampling is more systematic.

Under these conditions, it would seem desirable to separate acoustic and biological sampling. It seems obvious that this would result in a much better use of the allocated time as well as make planning easier. Two main methods may be considered - 1) use two different vessels at the same time, or 2) perform first the acoustic survey and then the biological sampling with a single boat. In practice, this is almost never done. One reason is the difficulty of obtaining two vessels. However, the principally experience suggests that it is very difficult to relate a particular kind of detection to a biological sample when the samples are not obtained simultaneously. Besides, the use of two boats would oblige one to perform intercalibration experiments, which adds a further variable to the survey.

All these observations show that biological sampling is not a simple process. A compromise must be found between the biological sampling design and the acoustic survey grid and must be included in the preliminary survey design.

Analysis and processing of the biological data must be carried out carefully. Almost all the biological sampling methods are species and length selective. Moreover, they have usually been applied on some particular echo traces, and the data may not be easily generalized. A particular type of detection corresponds usually to a particular population (see sections 3.3.3 and 4.1). The fact that the catchability of the species is different by day and by night must be taken into consideration too. This point may oblige the observers to correct their data, but is also helpful for further analysis. The diurnal difference in catchability of a single species may give information on its abundance.

An example extracted from a survey conducted in Venezuela shows some of the problems in the analytical process. In this region, the target species is the spanish sardine, *Sardinella aurita*. The distribution of the samples (pelagic trawling) corresponds to the population distribution (Figures 11a and 11b), and the majority of the trawling has been carried out in the high density area. Table 3 shows that the proportions of sardine in a trawl are often 1 or 0 - i.e. a school either is or is not caught. This data does not give reliable proportions for the whole area. For the entire region, the proportion of sardine (P_S) is approximately 70 % of the fish biomass in the fishing samples.

The proportion of this school biomass (P_B) corresponds approximately to 80 % of the total biomass B_t as observed from the acoustic data, the actual sardine biomass B_s is:-

$$B_s = B_t P_B P_s \quad (11)$$

that is, in this case, approximately 56 % of the total biomass.

This "1 or 0" sampling result presents a particular probabilistic problem, basically the same as the sorting of colour balls from a bag. If a bag contains balls of n colours, how many balls must be extracted from the bag before we have a precise estimate of the proportions of each colour? A simple probability calculation shows that for a reasonable number of colours (e.g. 10), the number of samples required for good results is much higher than the usual number of biological samples available during a survey. Therefore these biological samples can rarely be used directly. Before processing them they must be considered along with information from the environment as well as from the acoustic data set.

Once biological information (e.g. species proportion, demographic structure, etc.) is obtained for all the sampling points, it must be processed. Usually that means to map it on the same grid as the density data. There are several methods to do so, rather similar to those used for acoustic data processing.

The main problem in the case of biological samples is that of the interpolation between the sampling points. The way the data have been obtained and corrected makes it difficult to use simple interpolation laws, which may lead to errors. Figures 11c and 11d, from the same Venezuelan data set, demonstrate the importance of this point. Figure 11c is obtained using an "optimistic" interpolation law (i.e. sardines are everywhere except in the area where they have not been caught); while Figure 11d shows the results of a "pessimistic" interpolation (i.e. sardines are nowhere except on the points where they have been caught). To ensure good interpolation modelling, it is essential to use all the indirect information (e.g. fishery data, hydrological results, etc.) that are available.

For processing acoustic survey data three main kinds of biological information are required. Firstly, information on the structure of the community, principally the proportions (in biomass) of each species and their spatial distribution. Secondly, information on the demographic structure of the principal species, and thirdly information on the biology and physiology of the main species.

3.3.2 Fishing gear

The collection of biological samples is an important part of any acoustic survey. It is done to determine the species composition and the size distribution of targets detected by the echo-sounder. The samples are collected by fishing with a trawl or other type of gear. General information on the design and operation of fishing gear will be found in FAO (1972), Strange (1981), and von Brandt (1984).

It is not necessary to catch a large quantity of fish. More importantly, the size and species composition of the catch should be representative of the fish population in the area. Ideally, the gear should have the same efficiency in catching different species and sizes of fish - i.e. it should be "non-selective". Unfortunately, all fishing gears are selective to some extent (ICNAF, 1963).

Table 3. Proportions of *Sardinella aurita* in the trawl (survey ECHOVEN 2, 1986, Eastern Venezuela)

Trawl number	% of <i>S. aurita</i>
1	66.7
2	0
3	0
4	99.5
5	75.0
6	90.0
7	95.3
8	0
9	0
10	0
11	0
12	0
13	0
14	20.0
15	3.7
16	78.5
17	1.2
18	99.0
19	100.0
20	98.6
21	0
22	98.0
24	0.6
25	99.7
26	98.0
28	0
29	58.3

3.3.2.1 Trawls

The pelagic trawl is commonly used to sample echo-traces, and it is the recommended method for sampling species size and proportions, provided that the survey vessel has sufficient towing power and is equipped for this type of fishing. The objective in an acoustic survey is different from the catch-per-unit-effort (CPUE) trawling required for demersal surveys. Fishing at predetermined stations on dispersed layers or clusters of small schools may yield useful data. However, pelagic fishing for adult schooling fish on predetermined stations or depths is not advisable. Aimed trawling is used to sample a particular school or layer which has been detected by the shipboard echosounder. The survey stops, the ship turns and the trawl is shot, towing back along the survey track. The depth of the trawl is adjusted by reference to the netsonde echogram until it is the same as

that of the school. This method is most effective when search-light or multi-beam sonar is used to detect the school ahead of the vessel, since the fish may have moved off the survey track or changed depth. Pelagic trawling is not an effective method for sampling schools when it is carried out, without the aid of acoustic instruments. There is too much empty water between the schools and the chances of taking a representative catch by blind fishing are extremely slim. The use of a netsonde is still advisable even on predetermined stations as fish layers may change depth between vessel and trawl.

Fishing specifically at night may provide different information. In low light conditions avoidance may be less severe and the catch may be representative. However, care must be taken when applying data collected at one time of day to a different time. For example, fish on or very close the seabed, excluded from the survey in daylight, may move up in the water column and appear in trawl catches taken at night.

The pelagic trawl must not be too large in relation to the towing power of the vessel. Both the size of the net and speed of tow are important. A larger trawl may be able to catch fish at lower speeds. However, if the towing speed is too low, the larger fish (which can swim faster) may escape the net; while the smaller ones are caught more efficiently. On the other hand, the trawl must not be too small. It should have a mouth opening of at least 10 m in the fishing condition. Small nets may be unsuccessful because the fish do not have far to swim in order to escape (Wardle, 1983). Improvements in fishing capability of a vessel have been observed in some cases by using larger trawls at lower speeds and conversely, in different circumstances, by using smaller trawls at higher speeds. The pelagic trawl may not be the best choice for boats with engines smaller than 600 hp which would be unable to tow a large enough gear at the required speed. However, in the case of trawls conducted at night when the fish are dispersed, escape motivated by vision is less important and a small trawl towed at low speed may then provide adequate samples.

The catch from a sampling trawl and its relationship to the distribution of fish size and species present in the water has been studied extensively for demersal gears (Stewart and Galbraith, 1987; Engås and West, 1986; Foster et al, 1981). However studies of pelagic gears have been limited to some initial studies of avoidance (Ona, 1987), and some studies of mesh selectivity by Suuronen (1990) for herring, Nakashima (1990) for capelin, and Casey and Warns (1987) for mackerel. For survey work, codend mesh size is nearly always chosen to give minimum selectivity, and it is the relative catch efficiency of the trawl as a whole that must be understood. All trawls exhibit some bias in the sampling of the true size and species composition. Small fish are lost as they pass through the meshes unable to swim to avoid the netting panels. Large fish may swim easily with the net or may escape by swimming away at high speed escaping above the headline or below the foot rope. Trawls provide the best available method of obtaining relatively unbiased estimates of species and size composition in a heterogeneous area, but the data should always be used with caution.

3.3.2.2 Purse seines

The purse seine is selective in a different way. With the aid of sonar, it can be used to capture an entire school. It is an effective method for the study of school composition. The catch determines the total biomass which can then be compared with acoustic measurements of the school shape and density (Misund and Øvredal, 1988). Generally a purse seine is designed with a small mesh to insure that fish are not gilled, this ensures good size selectivity from each individual shot. However, the purse seine is not well-suited to the sampling requirements of echo-integrator surveys of mixed species or where size ranges may differ considerably. Several species may be present in the area, whereas each school will normally consist of one species only. Thus a few purse seine catches will not give a good indication of the species composition of the population at large. In tropical areas, schools may contain multiple species (Freon, 1984). The school structure is not thought to be homogeneous and capture by purse seine may not be independent of species. In some fisheries, the purse seine is used in conjunction with a fish aggregating device (FAD) using shadow during the day or artificial light at night to concentrate the fish. Again the catch will be some unknown selection from the local population. A purse seine is deployed from the surface and there will be some limitation to the maximum depth of operation, this may

be more severe than for trawling. Furthermore, purse seining is a highly skilled business. On no account should it be attempted as the primary sampling method on a vessel whose crew have no experience of working this gear.

3.3.2.3 Gill and drift nets

Different sampling problems arise in the case of surveys for very fast swimmers such as adult salmon. These fish cannot be caught by trawl, except perhaps for the occasional straggler. Samples may be taken by angling, drift or gill netting, but these methods are highly selective. Hamley (1975), in reviewing gillnet selectivity, provides an excellent review of the problems, and states "as a rule of thumb, few fish are caught whose length differ from the optimum by more than 20%". The bag net or the beach seine is a better choice for the sampling of migrating fish close to the shore. However, when the survey is to be done in a small lake, the population structure may be well known from other biological studies of the area, or it may be deduced from the catches taken by commercial or sport fishermen.

Drift nets and hooks on lines are highly selective in the size of fish taken. The use of selective gear is generally encouraged in commercial fishing, to reduce the mortality of young fish, but the opposite is required of the gears used for research surveys. For this reason, lines and drift nets should only be used to collect samples when no other method is available (e.g. if the vessel is not equipped to trawl).

3.3.3 Species identification by other methods

Biological sampling using fishing gear, whatever the gear may be, has two main disadvantages - 1) fishing is punctual in space and because it is time-consuming, the number of samples is small, and 2) fishing presents several sources of possible bias, due to behaviour characteristics (e.g. avoidance, escapement) and to the selectivity of the fishing gear. In consequence, fishing methods may introduce in the survey analysis some errors and biases that are much higher than those coming from the acoustic data. When considering that even in "simple" cases, such as two species populations (Nakken and Ulltang, 1983), sampling problems may cause real stock management problems, one may imagine how, in the case of multispecific populations, this point may become serious. As the time allocated to a survey is more or less constant, it is usually impossible to obtain as many fishing samples as necessary for a reasonably accurate estimation of the population structure.

Thus some different identification methods have been developed in order to overcome these limitations. The two main kinds of methods are those using visual or acoustical observations.

3.3.3.1 Visual methods

Visual methods may be performed using either direct eye observations or underwater cameras (photograph or video observations). There are very few examples of the use of visual methods during a routine survey. The main exception is the case of the visual sampling in tropical coral areas with very shallow waters (Thorne et al, 1989; Gerlotto et al, 1990), where the fish species and length proportions are determined and counted by scuba divers. This is evidently a very particular case, which may not be generalized, but the results appear to be excellent. Visual methods are only useable in the case of scattered or solitary fish. When observing pelagic schools, this method is only able to give the species identification. In other cases, the results are given in numbers of individuals per species along a transect (e.g. Claro and Garcia, 1990). As far as data analysis is concerned, the processing and analysis of these data are strictly identical to those of fishing samples.

The use of underwater cameras has been reported for particular studies, such as in situ observations on fish behaviour (Buerkle, 1983; Aoki and Inagaki, 1986), and for studying the reactions of the fish to a fishing net (Wardle, 1986; Glass and Wardle, 1989). We may also point out some potential calibration methods using underwater cameras for fish counting (Ermolchev and Zapherman, 1981; Freon and Gerlotto, 1989), but no

results have yet been published.

In the case of visual observation using cameras during an acoustic survey, only one paper has been published. Zapherman and Serebrov (1988) compare the results of acoustic, visual and fishing evaluation along the same transect on demersal fish (Figure 12). We do not mention here the works realized on anadromous/catadromous migrating fish, which are numerous but not applicable to a "classical" marine acoustic survey.

It is evident that the presence of a camera in the water column has probably a strong effect on the fish distribution. Glass and Wardle (1989) show that the lighting threshold in the viewing capabilities is extremely low in most of the fish species, and generally well below the range of the underwater cameras. In other words, before we are able to see them, fish have seen the camera and reacted.

3.3.3.2 Acoustic methods

Acoustic imaging (echography) has been studied for possible application to stock identification (Løvik, 1977; Fosse et al, 1986). This technique gives excellent results when applied through the use of very high frequencies, i.e. at a very short range (some centimetres). However, in the present state of the art, this method is not yet useable for survey sampling, and will not be discussed further.

The other, and more "classical" acoustic methods, may be separated into two groups - 1) methods which use exclusively acoustic information coming from the shape and strength of the acoustic signal reflected by a target, and 2) methods which take into account information coming from other sources, either acoustic or non acoustic, such as position in the water column, etc. Although the difference is not extremely important, for practical reasons we will consider first the direct methods and then the indirect methods (Table 4).

Direct acoustic methods of species identification are concerned exclusively with the characteristics of the echo itself. Two main technologies are employed: wide-band echo sounders and narrow-band echosounders. The use of wide-band echo sounders involves calculating a spectral analysis on the received echo. Simmonds and Armstrong (1987) use a cage in which several fishes of a single species are insonified. Le Bourges (1990) and Zakharia (1987) observe the echo from a single live fish maintained in a determinate position under the transducer. The analysis of the echoes may be simple (Simmonds and Armstrong, 1987) or followed by discriminant statistical methods, as in Le Bourges (1990), where the data are classified using factorial analysis. It can be also performed through the use of a special mathematical model built for this particular case (Zakharia, 1987; Zakharia and Sessarego, 1982). In almost all the cases, the results obtained show that this method using wide-band sounders allows one to discriminate various species with a good accuracy (Figures 13 and 14). As these methods still require separate species and experimental conditions, they cannot be assumed as yet useable for routine surveys. Nevertheless this method seems very promising.

For the narrow-band echo sounder technology, we know of only one series of published work using monofrequency sounders. Giryn et al (1981a; 1981b) have studied the echoes coming from a 38 kHz echo sounder. The information coming from the echo includes the target strength and the envelope of the echo signal, the angular frequency of the received echo pulse, the phase of the received echo pulse, and when processing multiple echoes, the spatial distributions of the targets. Finally a set of functions are calculated for all the detections. The mathematical model built from the complete set of information has been applied on 3 different echo types for a single species (horse mackerel) - i.e. schools, single layers and multiple layers (with a comparison with the bottom echo). The 3 types of distribution have been easily discriminated using the model. But from a practical point of view, this method also is still too experimental.

Indirect acoustic methods of species identification are useful in working with two different kinds of detections, schools and multispecies populations. The first attempts to classify schools observed on an echogram were from Azzali (1982), and Nion and Castaldo (1982). For classification, they used the shape and localization of the

school detection, which allowed them to discriminate between 3 and 5 groups. Two recent and more complete works have been published, which use information coming from the signal itself and other external data (e.g. distance between school and bottom, mean depth of the school, and school density or squared voltage). The data that are extracted from the signal are different in the two works. Rose and Legget (1988) use the standard deviation of the square voltage, the maximum square voltage, the mean distance between and within school voltage peaks, and mean peak to trough squared voltage. Souid (1989) takes into account the general geometry of the school including maximum height, maximum width, surface, perimeter, elongation, shape (rectangularity, circularity, geometric moments). Both authors can recognize with a good precision the species studied - i.e. herring, cod, and capelin (Rose and Legget, 1988), and herring, sardine and horse mackerel (Souid, 1989). Although it is not applied to schools, another work (Vray et al, 1987) is rather similar. The set of acoustic and non-acoustic parameters is extracted from the echo, its shape and position, and a linear discriminant function of Fisher is used for species recognition. The echoes in this work come from two species (*Coregonus lavaretus* and *Salvelinus alpinus*) of scattered fish in the lake of Annecy.

Indirect methods are also used in identification with multispecies populations. Gerlotto and Marchal (1987) introduced the concept of "acoustic populations" and have designed an approach principally for multispecific stock assessment. In this case, the objective is not to recognize a particular species, but to analyze the totality of the observations of a routine survey and to classify all the ESDUs (see section 3.5) according to a set of parameters. This is accomplished using hierarchical classification methods (e.g. factor analysis, dendrograms, etc.). The samples are then gathered in "acoustic populations" which are mapped. It is assumed that recognized differences depend on biological and ethological differences as well as differences in the species proportions existing in the natural populations, and that there exists a good correlation between natural and acoustic populations. The species distributions which represent these acoustic populations are determined by the fishing samples obtained during the survey. The parameters used for classification are: individual target strength, mean densities (echo integration), dispersion index (Marchal, 1988), day/night variations of the acoustic data, types and proportions of the biomass distribution (e.g. pelagic/demersal schools, scattered, concentration layers), and statistical characteristics of the density distribution. The authors give two examples which show a good coherence between acoustic populations and species distribution (Figure 15).

3.3.3.3 Survey application

The most promising direct methods are those using wide-band echo sounders. Once these equipments and methodologies are perfected, the direct determination of species through their "acoustic signatures" will certainly be very useful. Meanwhile, and as long as it necessitates experimental equipment, these methods cannot be considered as useable during a survey.

On the other hand, the indirect methods using conventional echo sounders are already applicable to standard surveys. Indirect methods are comparable in their methodology and involve three basic steps - i.e. selection of the discriminant parameters, selection of a classification method, and use of the results.

The largest set of possible discriminant parameters should be obtained, keeping in mind that all of them must be as independent as possible. Then each one must be tested, and only those presenting real discriminant power must be selected. Rose and Legget (1988) do not describe their "stepwise selection" method. Souid (1989) does not present any of the tests she has applied on her data set. Gerlotto and Marchal (1987) give some examples of the suitability of parameters using a correlation coefficient analysis, but do not present any discrimination method. There is here a regrettable lack of information. Once the discriminating criteria are selected, they must be gathered by observation units. In the case of schools, the observation unit is simply the school itself; in the case of acoustic populations, the observation unit is a geographical rectangle, which counts several ESDUs. Each rectangle will thus present a discriminating criteria set calculated with information coming from the ESDUs.

Table 4. Summary of the species identification methods.

author	sounder	frequency	analysis method	No.sp.	observations
S.A.87	wb	27-54	spectral analysis	4	on fishes in cage
LB.90	wb	50-144, 140-430	spect. an. factor an.	3	on single fish
G.R.S.81	nb	38	signal an.	1	on several fish structures
V.G.P.87	nb	70	Fourier transform	2	20 different par. (direct+indirect)
R.L.88	nb	120	signal an.	3	on schools (direct+indirect)
G.M.87	nb	120	signal an. factor an.	mult.	acoustic pop. (direct+indirect)
S.89	nb	38	signal an. factor an.	3	on schools (direct+indirect)
A.82	nb	-	signal an.	3	on schools (indirect param.)
Z.S.82	wb	40-80	spectral an. modelis.	-	-
B.K.86	wb	10-400	-	-	-
N.C.82	nb	-	signal an.	-	on schools (indirect param.)

wb = wide band, nb = narrow band, frequency in kHz, No.sp. number of species discriminated.

- S.A. Simmonds and Armstrong (1987)
- LB. Le Bourges (1990)
- G.R.S. Giry, Rojewski and Somla (1981)
- V.G.P. Vray, Gimenez and Person (1987)
- R.L. Rose and Legget (1988)
- G.M. Gerlotto and Marchal (1987)
- S. Souid (1989)
- A. Azzali (1982)
- Z.S. Zakharia and Sessarego (1982)
- B.K. Bjorno and Kjaergard (1986)
- N.C. Nion and Castaldo (1982)

All the authors have used discriminant analysis to classify the groups (species or populations). They show that this kind of statistical tool is well adapted to such a study (Figure 16). Different methods have been used, but it seems that the results have been positive whatever the type of method applied. So it is possible to recommend simply to use any method that would be easy-to-use, available in a computer software form, and compatible with the type of data to be processed.

For the indirect method working with fish schools, the result of the study is a distribution by species of the schools detected. This information is directly useable for calculating the school biomass per species in a defined area. Here we must point out a bias risk due to possible differences in the circadian behaviour of the species. Usually the best fish biomass index comes from the night survey on scattered fish, and the information on the schools from day detections. If applying the species proportions, calculated from school classification, on the night data, one must assume that the species proportions by night in scattered concentrations are the same as

the school proportions by day. In some other situations, the day distribution is the only one available (e.g. when fish are scattered in dense plankton layers by night). In this case, a direct school identification is useable, but other problems may appear. This demonstrates the importance of prior knowledge of the behaviour of the fish. When this is the case, the method is powerful. It can be totally automated, and as such will give continuous information on the school population observed during a survey (Diner, pers. comm.).

For the indirect method working with acoustic populations, once the rectangles are defined (section 4.2.6), they are gathered in populations through a hierarchical classification, and finally drawn on the map. The transformation of these acoustic populations to species groups (natural communities) is obtained using the results of the fishing samples of the survey, averaged for each acoustic population. This step reveals a limitation of the method. It gives a good stratification tool according to the populations, but the proportions of the biomass for the main species depend on the efficiency of the fishing gear, and all the biases which could be introduced are directly transmitted to the proportion results. Its main advantage, compared to the direct use of the fishing data, lies in the improvements in interpolation, due to the use of the totality of the acoustic data, which are much more numerous than the fishing samples. For an equal representation, it permits an important reduction of the fishing sampling effort.

3.4 Calculation of survey time/track length

It is important to be able to determine the time available for the collection of acoustic data, which we call the track-time. Ideally, this should be decided on the basis of the sampling intensity needed to map the stock with acceptable precision. In practice, the acoustic sampling is often constrained by the availability of the ship or other resources. Thus we begin with T, the total period within which the survey must be completed. The track-time is calculated by deducting from T the time required for other activities, such as loading and unloading the ship (L), and travelling between the embarkation point and the survey area if they are not immediately adjacent (M). It is also necessary to allow some time for the calibration of the acoustic instruments (C), fishing to identify the echo-traces (F) and hydrographic stations (H). A contingency for bad weather (W) should also be included. Furthermore, the track-time may be restricted to part of each day. If the fish migrate vertically in a diurnal cycle, the survey must be done during the hours when the fish are in midwater. Some surveys will be restricted to the daylight hours when the fish are concentrated in schools. Others may be done only at night when the targets are dispersed. The important point is to ensure that the behaviour of the detected fish is consistent throughout the period of the day used for the survey track, or the track must be designed to take into account any systematic differences with time of day. The planning in advance of the survey must provide for all the ancillary activities as well as the collection of acoustic samples. It is not essential to conduct hydrographic stations if the environmental conditions are well enough known from other sources.

If v is the ship speed and P is the proportion of each day which can be used for echo-integration, the total length of the cruise track is calculated as:-

$$D = [T - L - M - C - (F + H + W)P]v \quad (12)$$

It is necessary to decide in advance on a general scheme for allocating time between the different activities. For example, hydrographic data might be collected at selected positions along the cruise track. Each station might occupy an hour or so, depending on the water depth to be covered and the type of instrumentation which is available. Calibrations should not be performed in haste and several hours must be allowed to do the job properly. The need for fishing is more difficult to predict, since fish samples are required only to partition the acoustic data between species and size groups of fish. However, it may be decided to allow for a certain number of trawl stations each day on average, and then to fish as and when there is doubt about the identity of the echo-traces. As a rough guide, somewhere between 10% to 30% of the working time might be allowed for fishing on echo-traces. The lower level for almost homogeneous populations of an easily identifiable single species (see

section 3.3.3). The upper limit is for areas with a large range of species in mixed aggregations. It may require 1-3 hours to complete a trawl station on a large ship, and perhaps 30 minutes when using a light gear deployed from a small boat.

To assist with the layout of cruise tracks, it is useful to establish the transect spacing and the number of transects that may be undertaken. The available distance D for the survey may be used to determine the number of transects or the transect spacing. If A is the total area and a_1 the average transect length. The number of transects N_t is given approximately as:-

$$N_t \approx D/a_1 \quad (13)$$

The transect spacing S_t is approximately:-

$$S_t \approx A/D \quad (14)$$

These equations are exact for a parallel grid with transect ends at half transect spacing from the boundary. For full length parallel transects, $D-a_2$ should be substituted for D to take account of the end sections of the track, where a_2 is the dimension of the area normal to the transects. For wide areas surveyed with zig-zag transects (i.e. $a_1 > 5 \cdot A/D$), the approximate formula given above is sufficient. For narrow areas with zig-zag transects, more accurate relationships are:-

$$N_t \approx \sqrt{(D^2 - a_2^2)}/a_1 \quad (15)$$

and:-

$$S_t \approx a_2/N_t \quad (16)$$

These approximate relationships are largely independent of the shape of an area, although for some very irregular areas (e.g. fjords) they may break down. They require that a survey grid is constructed on a single baseline parallel to a_1 . If the area to be surveyed is complex and a number of baselines are required, the calculations can be carried out for each part of the area separately. Although the relationships are dependent to some extent on the shape of the area, the approximations are accurate enough for survey planning. The value of S_t is useful for establishing whether the resources are sufficient for multiple levels of sampling.

3.5 Interval for averaging (ESDU)

The Elementary Sampling Distance Unit (ESDU) is the length of cruise track along which the acoustic measurements are averaged to give one sample. The survey is conducted by collecting a series of samples from contiguous sections of track. Each sample, 1 ESDU long is considered to be representative of the fish density along the corresponding section of track.

The optimum length of the ESDU must be decided at an early stage of the survey design. If the ESDU is too large, potentially useful information about the geographical distribution of the stock will be lost. If it is too small, successive samples will be correlated; in which case, it may be more difficult to determine the confidence limits on the stock abundance estimate. As a general rule, the ESDU should be just large enough so that in regions where fish are observed, the correlation between pairs of successive samples is acceptably small. In this context, "acceptably small" means that the error limits (at the 95% confidence level) on the correlation

coefficient estimated from the observed fish densities should encompass zero (MacLennan and MacKenzie, 1988). Laloe (1985) sets the following conditions - 1) no correlation between density and error within an ESDU, 2) no correlation between errors in 2 successive ESDU, and 3) the covariance between the biomass in two ESDU is only dependent on their distance apart. The ESDU must be longer than the microstructure (i.e. schools) and smaller than the macrostructure (i.e. patches of population).

If data analysis is performed by calculating the abundance in elementary units of area, there should be several samples within each area element whose width (distance between transects) would normally therefore be much larger than the ESDU. The size of the element of area may be restricted by other considerations; in which case the need for adequate sampling may require an ESDU which is too short to avoid the serial correlation. Various analysis techniques have been proposed to overcome this problem (see sections 4.2 and 4.5.1), but there is nevertheless doubt as to whether reliable confidence limits on the abundance estimate can be determined from a series of samples which is serially correlated. It may be that stratification of an area reduces the level of correlation. However, if this is not sufficient, it is better to avoid the problem by choosing the ESDU to be large enough so that the acoustic data may reasonably be considered as uncorrelated. Alternatively, the use of models, such as geostatistics, that attempt to include the serial correlation within the model may overcome this problem.

The optimum length of the ESDU may be known from previous surveys of the same area. If not, it may be decided on the basis of normal practice on surveys of similar areas elsewhere. The ESDU may be as short as 0.1 nautical mile (1 nmi = 1853 m) which would be appropriate to dense schools within a fjord, or as much as 10 nmi in the case of species which are widely distributed over large areas of ocean. More usually the ESDU might be in the range 1 to 5 nmi. If it is possible to collect data on a fine scale, the size of the ESDU may be set at the optimum after the survey.

It is often convenient to organise the data collection within intervals of time rather than distance. If the vessel travels at 10 knots, then 1 nmi of track is covered in 6 minutes of time. If it had been decided that the ESDU should be 1 nmi, then the samples may be recorded as the average fish density observed in 6 minute intervals. The correspondence between the elapsed time and the distance travelled may not be exact, if the vessel speed is uncertain, but this is not an important factor unless vessel speed is related to stock density. The value obtained for each ESDU is an unbiased estimate of mean echo intensity, and thus stock density, irrespective of the method of defining the length of the ESDU. It is in combining the ESDU values to obtain a mean that the effects of change in speed may be important. Care should be taken to use actual vessel speed if the survey is conducted with a range of speeds. The distance travelled may be used as a weighting factor applied to individual ESDU. Alternatively where speed variation is small, variation in distance travelled that is unrelated to stock density can be regarded as a small random variable in the estimates of mean density.

4 DATA ANALYSIS

4.1 Species composition

There are large differences in species complexity between areas. In general it increases when moving from polar areas towards tropical areas. Different areas require different procedures for analyzing survey data. A general description can therefore not cover the details regarding each procedure. Venema (1985) is a useful start for a literature search on acoustic surveys in particular areas.

4.1.1 Partitioning (Judging) echo integrals or counts

The partitioning may be considered in two steps: First; obtain a value for fish by removing contributions from plankton, air bubbles, bottom and noise. Second; allocate the total fish value to species or groups of species. Both operations are usually made within convenient depth intervals. The appearance of the recordings on the echogram is usually the main basis for this proportioning. It is important that all signals contributing to the

integrals are visible on the echogram so that both the strength and the extension of signals from various sources can be judged from the echogram.

Contributions from plankton normally have wide extension, while the strength tend to vary between areas and seasons. The degree of mixing with fish recordings tend to be lower during day compared to night. In some cases only day values have been considered useful for estimating fish abundance (Masse 1988).

When mixed with fish, the contribution from plankton recordings of moderate strength may be judged by comparing with values obtained at other ESDUs (elementary sampling distance units) with similar plankton recordings not containing fish. Another widely used technique, which is particularly useful when plankton layers contain schooled fish, is to inspect the cumulative graph of contributions over the ESDU. On such a graph the plankton usually gives a continuous increase, while schools give a larger jump from one transmission to the next. Thereby the school contributions can be read out of the graph.

Some modern scientific echo sounders like "Simrad ES400" and "Simrad EK500" (Bodholt 1990) are able to estimate target strength from each individual echo accepted as a single target. This is helpful for verifying and partly quantifying the presence of scattered fish in plankton layers of moderate strength. It is also a guide to the size of the fish present, which sometimes is sufficient information for discriminating species.

Dense plankton recordings may occasionally totally mask the fish recordings. Some improvement may be obtained by adjusting the gain or threshold settings or by postprocessing of resolved data. In some cases the ratio between values obtained at different frequencies may give a useful indication of the proportion of fish in plankton recordings (Sætersdal et al. 1983). When none of these techniques work, the observations cannot be used quantitatively.

As a rule conditions leading to significant contributions from noise and air bubbles should be avoided. When they occasionally occurs, they may give strong signals. The same is the case with contributions from bottom echoes. In such cases the values of fish may be judged directly by comparing with other ESDUs, or large contributions from bottom, bubbles or noise can be taken out from a cumulative graph. Also in these cases postprocessing of resolved data provides an opportunity to "filter out" such contributions.

Allocation of fish values to species or groups of species can be made by recognizing types of recordings identified through catches or, in the case of mixed species, by applying the species composition in catches considered representative for mixed fish recordings. Both techniques may be used simultaneously; One particular species may occur both in pure recordings typical for the species and in recordings containing several species. These two situations usually occur in different depth intervals, different areas or at different time of the day.

When a catch (or combination of catches) considered representative for mixed recordings is used to estimate the integrator contribution for each species, the target strength of each species and size group involved is needed.

If the total fish density represented by mixed recordings is estimated from an in situ estimate of average target strength of the recordings, the total density may be allocated on species by applying their proportions in the catches, without knowing the target strength of each of them. For most surveys the opportunities to get such in situ measurements are quite limited.

4.1.2 Analysis of fishing samples

The previous section points out that the species composition in fishing samples may be needed for allocating integrator values to species. In addition, from a biological point of view it is always interesting to know which species tend to occur together. The length distribution of each species is needed both for estimating average backscattering cross section and for slitting the abundance estimate between length or age groups (through age

or age/length keys). The data from trawl hauls needs to be examined carefully. There will be differences in length and age composition. The treatment of the data depends on the reasons for the differences, which may be due to random sampling error or to real differences in the spatial distribution of fish sizes. If all the variation is due to spatial changes, individual fishing sample could be applied to the nearest acoustic observations. It remains only to decide how far from the catch position the sample should be considered representative. If most of the between haul differences are just random then hauls should be grouped to provide mean length or age keys for an area. The fishing samples are usually acquired on a non random basis, fishing is on detected echo traces. If sample variability is due to random effects and the hauls are allocated individually this procedure will cause considerable errors on the total estimate.

4.1.2.1 Combining length samples

The usual procedure is to average the length distributions obtained within strata of convenient size. The strata might be the common statistical areas for reporting commercial catches, areas defined from prior knowledge of the geographical distribution of different size groups, depth strata, or any combination of these.

Assume that within a strata n samples containing a certain species are obtained. The average fraction (f_i) of length group i is then calculated as:-

$$f_i = \frac{1}{\sum_{j=1}^n a_j} \sum_{j=1}^n a_j f_{ij} \quad (17)$$

where f_{ij} is the fraction of length group i in sample j and a_j is the weighting factor for sample j .

The weighting factors depend on how the trawl catches are considered. Two main cases may be listed:

1. Catch rates assumed proportional to abundance: Each sample weighted according to the catch rate of the species.
2. Catch rates poorly related to abundance: Equal weight to all samples, or weight proportional to neighbouring echo integrator values of the species (Traynor and Nelson 1985).

Small samples (too few measurements to have a good length distribution) may require special treatment. A simple procedure is just to exclude them. Then there is a risk that significant additional information is thrown away, particularly if the number of good samples in the stratum is low. If few measurements is the result of a low catch rate, no special treatment is required in case 1. In case 2 a useful additional weighting factor taking the number measured (n_j) into account would be (n_j/c) , where c is the minimum size for a good sample. This additional factor could be set to 1 when n_j is greater than c .

4.1.2.2 Combining species proportions

In some respects errors in species allocation are more serious than errors in allocation on length groups. For repeated trawl hauls, the between haul variability of the species composition seems more pronounced than the variability of the length composition (Barnes and Bagenal 1951, Engås and Godø 1987b). There are therefore strong reasons for combining species compositions. On the other hand it is important not to smooth out the real differences between areas. A useful prestratification will require good knowledge about the distribution of the species involved. Separating the region into depth strata is usually quite helpful in defining sub areas of similar species proportion.

The average fraction (f_s) of species s within a stratum is calculated as:-

$$f_s = \frac{1}{\sum_{j=1}^n a_j} \sum_{j=1}^n a_j f_{sj} \quad (18)$$

where n is the number of valid samples and f_{sj} is the fraction of species s in sample j . The considerations listed in the previous section should be used for deciding whether weighting factors should be equal, based on total catch rates, integrator values of mixed recordings or total number of fish in each sample.

4.1.2.3 Testing for regions of homogenous length or species proportion.

A common reason for working out survey data by sub-areas is to have a geographical resolution convenient for comparing biological results like fish abundance, fish size and age. The statistical reason for stratifying is to reduce the variance of the total result. A good check for obtaining reasonable improvement by stratifying is that the resulting within strata variances are smaller than the between strata variance. This means that when defining strata one should aim for rather homogenous length and species compositions.

The strata definitions may be based on earlier experience from the area (prestratification) or on analysis on the present data (poststratification). It is desirable to have tests for defining areas with homogenous length or species distributions. Such tests are not widely applied. It seems most common to define the areas by just inspecting the distributions. For testing similarities of length distributions a Kolmogorov Smirnov test has been applied in Kirkegaard et al. 1990.

Simard and Savard (1990) present an analysis of length frequency distributions (LFD) of shrimp. They considered the LFD as a multivariate and analysed the spatial structure with cluster analysis, dissimilarity variograms and correlograms. They concluded: "The LFD were spatially autocorrelated over a wide range of scales, and well defined homogenous assemblages were observed in each region every year".

The classification of "acoustic populations" described in section 3.3.3 is a kind of poststratification using the species composition in fishing samples as one important parameter.

4.2 Spatial Averaging

4.2.1 General principles

Acoustic data are usually collected along a succession of transects carried out by the survey vessel. The average fish density is calculated for each Elementary Sampling Distance Unit (ESDU), usually a linear distance from .1 up to 5 nautical miles. These ESDUs are the statistical samples, which are normally assumed:

- to be internally homogeneous (Laloe, 1985);
- to display a serial (auto-) correlation (MacLennan and MacKenzie, 1989; Barbieri, 1982);

The amplitude distribution of density values is usually far from normal, and may be log-normal, and in most of the cases, non stationary and anisotropic. (Laloe, 1985; Gohin, 1985)

An acoustic survey may have two main objectives: (1) delimitation of the area of distribution of the population (for biological and ecological information), and (2) evaluation of the population's biomass (Foote and Stefansson, 1990).

The scientist must have a clear idea of the priorities in his work before processing the data. Very often the sur-

vey will be designed for a particular objective, see section 3.2.

Let us consider the classical case, where the survey has been designed in a "conventional" way, i.e. with a reasonably regular grid of parallel transects over the whole survey area. This results in a set of data from which the scientist may want to extract two parameters : biomass information, with a confidence interval, and ecological information. Such as spatial distribution (mapping), relationships between fish density and spatial distribution or relationships with environmental factors, or with time (circadian, moon or annual cycles, etc..). The diversity of these objectives, suggests one or more methods for spatial averaging may be necessary.

We can see that the data samples must be processed, mapped and "stratified" for better interpretation. Strata are usually areas where the amplitude distribution of the samples is statistically more homogeneous than in the total area. Ideally strata are chosen using several criteria which allow one to plan the route prior to the survey. This "pre stratification" is detailed in section 3.1.1.

In pelagic ecology, it is often impossible to define permanent structures. Using previous observations for pre stratification schemes can result in unhelpful results (Margalef, 1967; Ibanez, 1983). One possible approach to this problem is to cut the total area into various portions after the survey, and analyze the results for each sub-area. Usually the criteria used are geographical such as the surface covered by a transect or a rectangle, but can be ecological using either external parameters such as temperature, salinity, depth or the density distribution itself (contouring).

This "post stratification", presents advantages and limitations that will be studied here. The general principles of stratification have already been presented (section 3.1.1). Strata delimitation is performed through 3 steps (Cochran, 1977; Frontier, 1983). Selection of stratification criteria. The theoretically best criteria is the variable itself, providing that it is exhaustively known, which is usually not the case. Nevertheless this is sometimes used when a density map is required. A second solution is to use those parameters which are correlated with the variable under study. Selection of the number of strata. The optimal number of strata depends on the relation between the cost, and practical feasibility, of the stratification and the reduction of the variance. Depending on the kind of data used and the aim of the analysis, the benefit is quickly obtained. As a simple example, Cochran (1977) calculates that for a variable x used for stratifying a data set y , such as:-

$$y = \phi(x) + e \tag{19}$$

where x and e are uncorrelated, then:-

$$s_y^2 = s_x^2 + s_e^2 \tag{20}$$

s_x decreases with the square of H the number of strata, but s_e remains unchanged: in these conditions when s_y approaches s_e , the increase in the number of strata will not reduce the variance. In typical fisheries data sets, we consider as a rule of thumb that no benefit can be expected when the number of strata is above 5-10.

If the strata criteria are quantitative (fish density for instance), the strata limits can be adjusted to minimise the variance. Several methods exist for doing so (Cochran, 1977; Dalenius and Hodges, 1959). Johannesson and Mitson (1982) propose a method with logarithmic steps as strata limits, decimal or natural logarithms, according to the density range. Their concept of logarithmic steps for contour levels is very useful, however, the complete method as stated explicitly in the paper can lead to some problems.

As usual in fisheries acoustics when attempting to apply statistical methods, there is no general agreement on the use of stratification, and above all on post stratification. In order to test their efficiency, we have applied the most common methods of spatial averaging on a simple data set, a survey performed in Senegal (Gerlotto *et al.*, 1976). All the results of the different spatial averaging methods are presented in Table 5.

We have not use transformed data in these examples, but it may be important to note that the type of amplitude distribution encountered may lead to some limitations in the application of some statistical techniques, such as the use of parametric tests.

Nevertheless, for comparisons between the different methods, we need a common index. We have chosen the confidence interval calculated from the variance, although keeping in mind the above mentioned limitations.

As there are many possible variance calculation methods, we have selected the simplest and most used one (from Cochran, 1977; Frontier, 1983; Shotton and Bazigos, 1984).

The working area A is divided in H strata, each one with a surface A_h . The mean density in each strata is:-

$$\bar{y}_h = \frac{1}{n_h} \sum_{i_h=1}^{n_h} y_{ih} \quad (21)$$

where y_{ih} is the density of the i th ESDU in the h th stratum and n_h is the number of ESDUs in h . In this stratum, the variance of the density is:-

$$s_h^2 = \frac{1}{(n_h-1)} \sum_{i_h=1}^{n_h} (y_{ih} - \bar{y}_h)^2 \quad (22)$$

The biomass of a strata B_h is calculated as:-

(23)

$$B_h = \bar{y}_h A_h$$

Considering the total stratified population, we obtain for the total biomass:-

$$B_{st} = \sum_{h=1}^H B_h \quad (24)$$

When assuming that n_h is much smaller than total number of possible samples from stratum h , the variance of the mean density is:-

$$Var(\bar{y}_{st}) = \sum_{h=1}^H (A_h/A)^2 s_h^2 / n_h \quad (25)$$

and the variance of the total stratified biomass is:-

$$Var(B_{st}) = A^2 Var(\bar{y}_{st}) \quad (26)$$

A number of other methods exist for post-stratified processing of the data, such as cluster analysis, bootstrap method, etc... (Williamson, 1982; Robotham and Castillo, 1987; Francis, 1985, etc...), which will be presented later. Our objective here is to compare various data averaging methods, for this purpose we require an index.

4.2.2 No stratification

This is the simplest method of calculating the biomass and the confidence interval: all the ESDUs are taken into account in the variance calculation.

One important constraint in this method is that every ESDU must be equi-representative. Therefore there is a requirement to omit all the ESDUs obtained between transects, in transit, and any sections of track which are from non-systematic, non regular grid. The transects that are used must be parallel.

- Advantages of the method.

It is very simple to apply, and the variance result is easy to interpret

- Disadvantages

Relatively high variance particularly if the stock is non-stationary.

It is not applicable on a non uniform grid, i.e. it is not possible to stratify the sampling effort.

The survey grid should be parallel either random or systematic, and ideally perpendicular to the axis of anisotropy

The autocorrelation between the ESDU is not accounted for (see for instance MacLennan and MacKenzie, 1988). It does not give any detailed ecological information, such as spatial distribution, patchiness, etc.

All these disadvantages show clearly that except in some very particular cases, a simple variance calculation on the total data set does not really reflect the true sampling variance.

A second non-stratified method consists of considering the complete transect as a single sample. As the transect is exhaustively known, this assumption is valid: "the data set is now one dimensional and there is no error on each of the transect cumulated data" (Petitgas, 1990). Using the weighting method for transect length described above, which is the same as the method proposed by Jolly and Hampton (1990) on the data of the Senegalese survey, we obtain the results presented in Table 5.

- Advantages

It removes the problem of autocorrelation between the ESDUs along the transects.

'Classical statistics' are more applicable.

Elimination of the along-transect variability results in a reduction of sampling variance. making it possible to use "classical" statistics.

- Disadvantages

There is no information the variability along the transect. Although this variability may be eliminated in the calculation process, following Petitgas (1990), when considering the transect *in toto*. The variability inside the area represented by the transect still exists, and might reveal interesting ecological information.

There is the same constraint as above on the grid type (elimination of all the non regular sections)

If successive transects have not been placed randomly the sampling process may not be random. The literature

is contradictory on this point. For instance, Jolly and Hampton (1990) suggest that this independence of the transects is only obtained when the transects are random distributed inside the stratum. When this is not the case, "no fully valid estimation of sampling error can be made from a single survey unless the population is randomly distributed". In contrast Francis (1984) suggests that the regular spacing reduces autocorrelation between transects, they are placed on average at the largest possible distance. Observations in tropical waters (Gerlotto 1990) have indicated that the variability of the results obtained on a single replicate transect, suggest that temporal variability at a point in space indicates that the stock distribution can be regarded as random and regularly spaced transects considered as randomly distributed inside the strata. Finally we may note that other authors (Petitgas, 1990) take advantage of this autocorrelation for applying spatial statistics models for variance calculation.

Considering these points, it is clear that using the transects as samples is much better than using the ESDUs, for calculating the variance, but there may be limitations on the grid design.

4.2.3 Stratification in transects

The principle is to consider an area represented by a single transect as a stratum. This area being generally a rectangle the length of which is the length of the transect, and the width being the two half distances between the two neighbouring transects. The ESDU are presumed to be independent.

This post stratification method supposes that the strata are independent i.e. no autocorrelation between two successive transects. This controversial point has been discussed above.

When using the ESDUs as samples for the 14 strata or transects in the study of the Senegalese data we obtain the results detailed in Table 5.

- Advantages

More or less the same as when using no stratification

- Disadvantages

Any autocorrelation between the successive ESDUs theoretically invalidates this calculation, and consequently the variance result has probably little significance.

As before, non random positioning of the transects may lead to some limitations.

A stratum is supposed to be homogeneous, while the transect is usually placed along the axis of greatest heterogeneity.

As with the case of no-stratification, this method places strong constraints on the survey design.

No change of the variance compared to unstratified method (see Table 5) because of the heterogeneity of the data in each stratum.

When using the ESDUs as samples, this method is not very efficient, and is probably not useful normally. In contrast, one interesting aspect of the use of transects as strata is the possibility of applying an alternative method, such as cluster analysis (see section 4.5.1.4), which is able to take into account the autocorrelation between the ESDU. The use of the transect as sample has already been considered in section 4.2.2.

4.2.4 Stratification in blocks

In this case the complete area A of the survey is divided into several blocks, each one containing several transects or pieces of transects. This stratification method has been used by various authors as pre-stratification, for example Jolly and Hampton (1990). For this method of analysis the transect is usually used as a data point or a cluster.

This method seems particularly useful when applied with more developed statistical tools. Williamson (1982) has applied cluster analysis on north Pacific surveys, and Robotham and Castillo (1990) have used bootstrap on pelagic stocks off Chile. More details of these methods are included in sections 4.5.1.2 and 4.5.1.4. Although the principles of these methods are quite different they attempt to take account of autocorrelation within a transect.

- Advantages

The principle advantage is that the calculation of variance is more reliable when the data shows autocorrelation. If cluster analysis is used the distribution of ESDU values is also taken into account.

Intra-transect variation is taken into account.

The strata are not constructed from the ESDU or transect density values and do not introduce bias into the estimate of precision.

-Disadvantages

The statistical methods are more complex

The strata must be chosen to be as independent as possible and should preferably be based on ecological data.

The restrictions on transect design and data usage are the same as for sections 4.2.2-4

One particular variant of this method is the use of collapsed strata (Cochran 1977, Shotton and Bazigos, 1984). In this case the strata include two transects, each transect is regarded as a sample. The Principle of the variance calculation is described in Bazigos 1975. The results from the Senegalese data is shown in table 5.

-Advantages

The variance is usually lower because the along transect variance has been ignored.

Easy to compute.

Avoids the problems caused by autocorrelation between ESDUs.

4.2.5 Contouring

This method consists in drawing strata boundaries according to the distribution of one or more parameters that are considered as describing the population in the best possible way. These parameters are derived from 3 sources:

- geographical, the depth is the most common. Strata boundaries follow isobath lines, and can be defined very precisely.

- ecological: the contour parameter is either hydrological (e.g. salinity, see Francis, 1985) or biological, such as species proportions or demographic structure.

- acoustic: usually the density values.

The two last cases are rather similar because they depend upon data with temporal variability and they may depend on the operator's subjectivity. The last method employing fish density values is the most contentious and we will concentrate on this technique here.

The ESDU values are the samples. They are plotted on a map and isodensity areas are defined, using generally 3 to 5 density levels. The principle and details of the method are presented by Johannesson and Mitson (1982), and we have used a logarithmic scale for strata boundary delimitation for the Senegalese data, as they suggest. Once the contours are drawn, each density group is considered as a stratum, and variance calculation are applied in a classical way (see above).

The most important step in this method is the choice of the contouring criteria. Figure 17 gives some examples

of different contouring strategies applied on the data set, using contouring software (SURFER, Golden Software Inc.).

The main criteria that have been considered are:

- anisotropy (autocorrelation in E-W and N-S axis)
- intra-stratum variability
- values of the strata boundaries
- biological homogeneity of the population
- hydrological characteristics.

The results for the various contour criteria are detailed in Table 5.

Spatial averaging using contouring is probably the most often used method for mapping and the most illuminating for ecological studies. It gives a lot of information on the position of the population, its concentration mode, its patchiness, its relationship with the hydrology, etc..

It is also the most controversial, principally because it uses the data itself as stratum criteria. Thus the value of the precision depends directly on the operator's decision. Cochran (1977) shows that when using the variable y as stratification criteria, the calculated variance decreases with the square of the number of strata, H :-

For this type of strata delimitation, Jolly and Hampton (1987) show that the variance may approach zero when a large number of strata are used. Therefore, when using contouring it is advisable to limit the number of strata to a small number such as 4 or 5, as in Johannesson and Mitson (1983) because the density boundaries can have good ecological meaning. Nevertheless, using the density values as a contouring or stratification criteria biases the estimates of precision making it unreliable. In addition the abundance estimate may also be biased but to a much smaller extent.

This problem should disappear when the stratification criteria is not density but an alternate parameter which is known to have a strong influence (correlation) on the density distribution. Francis (1985) uses the salinity distribution, for instance. This approach may suffer from three possible sources of errors:

- one must be sure that the external parameter is genuinely correlated with the fish concentration. This may not be the case when the concentration is multispecific (as in our example from Senegal). Each species may react differently to the climatic conditions.
- the mapping of the external parameter must be as precise as that of the biomass.
- a particular problem of the use of external parameters has been pointed out by Petitgas and Poulard (1989): if the fish main concentration is situated across the strata boundaries, firstly these strata will not be homogeneous, and secondly they are not independent.

Perhaps the best approach is that already being used intuitively by many people. This involves mapping the densities while considering the ecology of the area, i.e. an appropriate "ecological spatial model". This has been done in case E (figure 17E), where the map has been fitted by eye taking into account several criteria a) the density distribution b) the existence of an up-welling area, which is almost exactly represented by the lowest stratum, c) the presence of three different populations, observed from the catch composition: one along the exterior limit of the shelf and, in the high density area, a population of *Sardinella aurita* along the 30 m depth line, and a population of *Sardinella maderensis* along the 10-20 m depth line.

Under these conditions, the use of strata which are defined by a combination of density values and ecological information may give the best results.

Furthermore this kind of stratification may reduce considerably the problems of autocorrelation. Gerlotto and Stequert (1983) and Gerlotto (1989) using the same data set have shown that the calculated autocorrelation within strata is much lower than the one from the total data set. This may be due to the non-stationary nature of the complete data set giving a false impression of the local autocorrelation, this is removed when suitable much more stationary strata are chosen. This can be seen in figure 18, which shows the regressions of the points i compared to the points $i+1$. For each stratum the points appear randomly distributed around a single level. When plotting the couples of points from the 4 strata on a single graph, we can see that they appear randomly distributed along a curve which passes through the mean density of each stratum. This may be explained by the fact that once the differences between ESDUs have been taken into account by a spatial model (the strata), the remaining observed variations are random and uncorrelated.

- Advantages

Excellent graphic representation of the concentrations (biological and ecological information).

Possibility of including in the stratification criteria set some external information

Good potential for correlating the results with other mapped information (such as fishing data, hydrology, etc..)

Reduced variance, due to the construction of homogeneous strata.

Partial elimination of autocorrelation problems, taking into account the main spatial structures.

Good homogeneity of the strata (in terms of density as well as in terms of ecology)

No constraint on the survey grid: all the routes may be included in the data processing, and any kind of route type may be processed in that way.

This method allows the inclusion, in the same processing operation, of data from both an outline survey and an adaptive survey in some particularly interesting areas (see section 3.2.2).

- Disadvantages

When the only available information are the density values, this kind of spatial averaging should be avoided, as it depends too much on the intuition of the scientist and gives unreliable estimates of variance.

When the only criteria are external data (ecology, hydrology, bathymetry...), the strata may be neither independent nor homogeneous;

The results are difficult to process using automatic analysis and calculation systems (although this can be automated more easily in some cases, such as when the criteria for defining the "ecological populations" are stable from year to year).

It requires the measurement of other variables (temperature, salinity, ecological populations, etc..) as well as acoustic data.

Another way to define strata boundaries has been suggested by Gerlotto and Marchal 1987 for tropical populations (i.e. highly multispecific), using acoustic populations. In this case the area is first divided in small regular elements (such as rectangles), and a set of information is detailed for each element, including acoustic data as well as fishing or hydrological data if necessary. A multivariate analysis is performed which collects elements into populations. Each population may be considered as a stratum.

The example in figure 19 is obtained using only acoustic data as stratification criteria. The validity of this has been confirmed later by comparing the strata mapping to ecological information (salinity and species distribution). The acoustic data used in the analysis are detailed in section 3.3.3.

In conclusion the contouring method does not appear as inapplicable as has been suggested. It is probably one of the best methods for giving biological and ecological information, when carefully employed. It is excellent when a lot is known about the area studied, but should be treated with caution when stratifying with data coming from a single source. In situations where the strata are defined independently of the density values information

on the precision may be obtained, however, use of the density data for contouring precludes calculations of precision.

Table 5. Results of several spatial averaging methods

Method	Map	Biomass	Variance	C.I.
No Stratification, Data is ESDU		157042	8.160 10 ⁸	17.8%
No Stratification, Data is Transect		157042	1.958 10 ⁸	9.9%
Stata by transect, Data is ESDU		157374	7.229 10 ⁸	16.8%
Collapsed Strata, Data is transect		157374	1.848 10 ⁸	8.5%
Contouring 1	(a)	158117	4.998 10 ⁸	13.8%
Contouring 2	(b)	158212	6.911 10 ⁸	16.3%
Contouring 3		158196	8.840 10 ⁸	18.4%
Contouring 4	(c)	158127	6.975 10 ⁸	16.4%
Contouring 5	(d)	158076	5.570 10 ⁸	14.7%
Contouring 6		160089	5.753 10 ⁸	14.7%
Contouring by eye	(e)	158073	2.574 10 ⁸	11.0%
Rectangle 10 by 20, Rectangle is Data,		163200	1.232 10 ⁸	5.5%
Strata by Rectangle 10 by 20, Data is ESDU	(g)	163200	6.899 10 ⁸	16.4%
Strata by Rectangle 10 by 30, data is ESDU	(h)	158260	7.295 10 ⁸	16.8%

Maps (a) to (h) are presented in figure 17.

- | | |
|--------------------------------|--------------------------------|
| a : isotropic, detailed | b : isotropic, smoothed |
| c : anisotropic, detailed | d : anisotropic, smoothed |
| e : "ecological modelling" | f : kriging |
| g : rectangles, 10x20 N. Miles | h : rectangles, 10x30 N. Miles |

4.2.6 Stratification in rectangles

This method consists of "dividing the area of interest into rectangles bounded by lines of latitude and longitude. The samples in each rectangle are assumed to come from a homogeneous distribution." (MacLennan and MacKenzie, 1985). It can be used in two ways, first, considering the rectangles as strata or second, as samples. The calculation of the variance will depend on the method selected.

It is important to find the appropriate dimensions for the rectangle. The rectangles must be large enough to remain independent of each other (Laloë, 1985; Gohin, 1985), according to the anisotropy existing in each direction and they must be small enough to remain internally homogeneous.

The optimal dimensions for the rectangles can be derived either from a correlogram (MacLennan and MacKenzie, 1985), or a variogram (Gerlotto, 1989). In the case of the Senegal data set Barbieri (1982) found a maximum autocorrelation less than 10 miles in the EW axis. The NS axis had a longer autocorrelation

distance, less than 20 miles. Therefore two types of rectangles, 10x20 and 10x30 miles have been used in this study (Table 5; Figure 17G and 17H), the ESDUs in each rectangle were considered to be the samples.

The results show that the actual dimension of the rectangle must be carefully selected. The 10x30 rectangles are too big and the variance is similar to the un-stratified case. This is probably due to the fact that the spatial structure of the concentrations are much smaller than the rectangle, which make the strata internally too heterogeneous. Alternatively too small a rectangle might underestimate the variance, due to the autocorrelation between strata. The best approach is to select dimensions which are just greater than the autocorrelation range.

- Advantages

There is good independence of the strata when appropriately dimensioned.

It is very easy to compute and to use in ecological models, such as acoustic populations.

and evaluation of the population structure according to the results of fishing inside the rectangles.

It allows reasonably good cartographic representation of the distribution of the concentrations.

There is limited subjectivity in the drawing of the strata.

There should be decrease of the variance compared to the unstratified method.

It allows the use of non regular grid, and the inclusion of "additional sampling" in some rectangles, as well as ESDUs from inter transect and irregular routes.

- Disadvantages

The autocorrelation of the ESDUs inside each rectangle is not considered, although it may be partly eliminated if it is due to non-stationarity within the whole survey area. A way to overcome this limitation is to use large ESDUs, as suggested by MacLennan and MacKenzie (1989), but this presents the disadvantage of a loss of information inside each rectangle.

The results may be biased if data from a regular grid and from adaptive sampling are combined in a single rectangle.

The applicability of this method may be limited by autocorrelation between strata.

4.2.7 Geostatistics

A detailed discussion of geostatistics is given in section 4.5.1.7.

There are two theoretical advantages to this method. Firstly, it explicitly includes the autocorrelation between ESDUs in the analysis. Secondly, it is unaffected by the statistics of the amplitude distribution of the density values. However, it is often more difficult to interpret variograms for highly skewed distributions such as the log-normal, and in such cases it may be useful to compute variograms on log-transformed data in addition to the untransformed data. (Englund and Sparks, 1988). Highly skewed distribution can be caused by non stationarity.

There are some limitations. Firstly, in simple geostatistics stationarity of the data is assumed. This is not always true, which limits the use of geostatistics (Gohin, 1984). Stationarity is particularly important for small distances, as kriging methods are often applied using only the beginning of the variogram model (Simard et al., 1991). However, there are techniques in geostatistics for non-stationary data, these will be discussed briefly in section 4.5.1.7.

Geostatistics was developed for the treatment of geological samples from immobile locations.

Simard and Gerlotto (1990) state that "since fishes are not sessile organisms but they continuously move, that violates basic conditions of geostatistics". These authors present a case where the same geographical point is sampled several times at different moments: very strong changes are seen in the variogram, which looks unstructured, due to temporal variations in the densities.

The choice of the the variogram model is a key point, and requires very careful attention. Any error or miscon-

ception at this stage would produce invalid estimates of the variance. However, errors in the variogram model will not bias the mean.

As we see, acoustic data do not straightforwardly satisfy the conditions for geostatistics, and may require particular models; nevertheless this method can be very useful in many cases and when applying it carefully it may give new information that may help to post-stratify the data.

We have used the software "GEOEAS" (Englund and Sparks, 1988) on the Senegal survey, on the complete data set as well as on some parts of it. The variograms that we have obtained show some typical phenomena (figure 20 and 21).

a) when applied on the complete data set

Anisotropy is apparent, with autocorrelation range between 9 (E-W) and 20 miles (N-S), although the lack of N-S short distance intervals makes this later result uncertain.

Autocorrelation is apparent, which shows that the density is a regionalized variable, although this is not evident when looking only at the non transformed data.

b) when applied on separated areas, split in two strata according to the density, a north stratum, with generally low densities (north of 13°10'N), and a dense south stratum.

Different variograms for each stratum: the south area gives a more straight forward variogram, with a range of about 6 miles, a very high sill (17000) with a low nugget effect (2000). In contrast the north area variogram shows a very low sill (110), a range of 4.5 miles and a nugget effect of 80. This example shows the relationship between the variogram and the mean density typical of fish distributions, as well as the non-stationarity of the autocorrelation.

When comparing two the different strata (figure 21) in the north we can see that there is practically no difference in the E-W and N-S variograms.

This exercise shows that it is possible first to calculate the variance of the density with a tool that is appropriate for autocorrelated samples, and that the models we can fit to the data may be used for strata characterisation.

Stratification performed in 3 steps:

a) delimitation of the strata

b) calculation of a variogram inside each stratum, and verification that this variogram is stable inside the stratum (stationarity and homogeneity)

c) comparison of the variograms obtained for each stratum, in order to check if the areas are significantly different.

For spatial averaging, first the density values are mapped using geostatistic model fitted to the data (figure 17F). It may be assumed that the map is better than when using other methods, as the interpolation is performed taking into account anisotropy, autocorrelation and the data values. The accuracy of the result will obviously depend on the agreement between the variogram model and the data.

-Advantages

The autocorrelation between data values is included in the model, and all the density values are taken into account through the interpolation method.

There is no requirement for independent samples.

The method can give information that may be used for strata delimitation if necessary. This could be particularly useful when defining biological strata. In this case it consists of defining one or several areas where the data may be stationary.

There is no requirement for the assumption of normality of the data. The method is very tolerant of the sampling design, although regular sampling would be preferred, with the exception of revisited areas which cause major problems. (Simard and Gerlotto, 1990).

-Disadvantages

Whether the data are stationary or not must be carefully checked, since this result will change the choice of the appropriate geostatistic tool and considerable caution is advised. It would probably be useful to split the area under study into several strata that could be more reasonably assumed as stationary, particularly in the case of multi specific stocks.

It has been shown that the spatial structure can be completely different when applied on a double sampled grid, than on a single grid, due to the fact that the spatial distribution has moved between the two sampling periods. This means that it is not always possible to apply a single method to the whole data set. Moreover any revisited areas will not give intelligible results, due to the spatial/temporal drift of the densities at a single point. Not all the grid designs are useable.

There is some subjectivity in the choice on best variogram model, from the data and his knowledge of the area. The calculations of precision will depend directly on the choice of the model describing the variogram.

Table 6. Preferred methods for spatial averaging

Type of Stock		Type of Grid				
Statistical Stationarity	Stock Spatial Structure	Regular Parallel	Regular Zig-zag	Random	Stratified	Adaptive
Mean and Variance Stationary	No Spatial Structure	N1 N2 ⁴	N1 N2 ⁴	N1 N2 ⁴	- ⁵	- ⁵
	Some Spatial Structure	T C1 C2 R G	T C1 C2 G	T ³ C1 ¹ C2 ¹ G	C1 ¹ C2 ¹ R ² G	C2 ¹ R ²
Mean and Variance Non Stationary	Some Spatial Structure	T C1 C2 R G	T C1 C2 G	T ³ C1 ¹ C2 ¹ G	C1 ¹ C2 ¹ R ² G	C2 ¹ R ²

N1 : no stratification, data is ESDU

N2 : no stratification, data is transect

T : stratification in blocks, data is transect

C1 : stratification by contouring using depth and/or hydrology

C2 : stratification by contouring using densities and ecology

R : rectangles

G : geostatistics

- 1) Any stratification of the survey grid must be linked to the contouring method.
- 2) Any stratification of the survey grid must be linked to choice of rectangle size
- 3) Any stratification of the survey grid must be linked to choice of analysis strata
- 4) Stratification is not applicable when there is no spatial structure.
- 5) Stratified coverage or adaptive strategies are not applicable when there is no structure.

4.2.8 Summary (comparison)

Firstly, there is no general, ideally adapted, method, and each one has some defects, depending either on the type of distribution or on the type of survey design. In general the method chosen must be based on the characteristics of the data set.

Secondly, except for geostatistics, it seems difficult to use the same tool for mapping and for mean and variance calculations. It is probably better to separate these two studies.

Thirdly, one very important point is the relationship between the grid used for the survey and the analysis method. It is necessary to match a particular grid design with a data analysis method.

The general relationships between survey grid, the data and the analysis method are presented in Table 6, which shows the use of the different methods according to the characteristics of the data and the output required. The types of distribution that are observed in practice suggest that the stationarity of the variance and the mean may be coupled.

From Table 6, it appears that, when considering the usual characteristics of the acoustic data, four methods seem the most useful : a) stratification in rectangles, b) by contouring using both density and ecological data, c) geostatistics and d) using stratified sampling with transects as data. Which one should be used would depend on the kind of grid used and the data available, but also on the objective of the study. This table though inevitably incomplete, can be used for matching a knowledge of stock structure to survey strategy.

4.3 The Echo-integrator Conversion Factor

Selection of areas with fish populations of homogenous size distribution or species composition was described in section 4.1.2. The extraction of echo integrator values or counts for each of these categories in 4.1.1. In section 4.2 we discussed methods for averaging the echo-integrator values and echo counts. The next step is to estimate the density of targets from the observed echo-integrals. This may be done using the following equation from Foote et al 1987:-

$$F_i = (K/\langle\sigma_i\rangle)E_i \quad (28)$$

The subscript i refers to one species or category of target. K is a calibration factor, $\langle\sigma_i\rangle$ is the mean acoustic cross-section of species i , E_i is the mean echo-integral after partitioning and F_i is the estimated area density of species i . The quantity is the number or weight of species i , depending on whether σ_i is the mean cross-section per fish or per unit weight. $c_i=(K/\langle\sigma_i\rangle)$ is the echo-integrator conversion factor, which may be different for each species. Furthermore, c_i depends upon the size-distribution of the insonified targets, and if this differs over the whole surveyed area, the calculated conversion factors must take the regional variation into account.

K is determined from the physical calibration of the equipment, which has is described in detail in Foote 1987. It does not depend upon the species or biological parameters. Several calibrations may be performed during a survey. The measured values of K may be different but they should be within 10% of one another. If two successive measurements are very different the cause should be investigated since the equipment may be malfunctioning. Otherwise, K should be taken as the average of the two measurements before and after the relevant part of the survey.

4.3.1 Single species

The mean cross-section $\langle\sigma\rangle$ may be determined directly from in situ measurements of target-strength made during the survey. In this case care must be taken to ensure that the targets providing the value are representative of the fish stock being surveyed.

Alternatively it may be derived from a function which describes the length-dependence of the target-strength, normally expressed in the form:-

$$TS = a_i + b_i \text{Log}_{10}(L) \quad (29)$$

a_i and b_i are constants for the i 'th species, obtained from experimental evidence and possibly by agreement with other participants in the survey.

The equivalent formula for the cross-section is:-

$$\sigma_i = 4\pi 10^{((a_i + b_i \text{Log}(L))/10)} \quad (30)$$

The mean cross-section is calculated as the σ average over the size-distribution of the insonified fish. Thus:-

$$\langle \sigma_i \rangle = 4\pi \sum_j f_{ij} 10^{((a_i + b_i \text{Log}(L_j))/10)} \quad (31)$$

L_j is the mid-point of the j 'th size-class and f_{ij} is the corresponding frequency as deduced from the fishing samples by the method described earlier (Section 4.1.2.1). The echo-integrator conversion factor is $c_i = K/\langle \sigma_i \rangle$. The calculation may be repeated for any species with a known target-strength function.

Note that it is the cross-section that is averaged, not the target-strength. The arithmetic average of the target-strengths gives a geometric mean, which is incorrect. The term "mean target-strength" may be encountered in the literature, but this is normally the target-strength equivalent to $\langle \sigma_i \rangle$, calculated as $10\log_{10}(\langle \sigma_i \rangle/4\pi)$. Some authors refer to TS as $10\log(\sigma_{bs})$ the definition of σ is different from σ_{bs} and should not be confused.

It is important to note that a number of different methods are in use for measuring fish length for example, fork length, overall length and standard length. It is essential to standardize on one method for length measurement and to ensure that target strength values obtained from other sources have been obtained using the same measurement method.

4.3.2 Mixed species

Sometimes several species are found in mixed concentrations such that the marks on the echogram due to each species cannot be distinguished. From inspection of the echogram, the echo-integrals can be partitioned to provide data for the mixture as one category, but not for the individual species. However, further partitioning to species level is possible by reference to the composition of the trawl catches (Nakken and Dommasnes, 1975). Suppose E_m is the echo-integral of the mixture, and w_i is the proportion of the i 'th species, calculated from fishing data see section 4.1.2.2. It is necessary to know the target-strength or the acoustic cross-section, which may be determined in the same manner as single species (see section 4.3.1). The fish density contributed by each species is proportional to w_i . Thus the partitioned fish densities are:-

$$F_i = \frac{w_i K}{\sum_i w_i \langle \sigma_i \rangle} E_m \quad (32)$$

The w_i may be expressed as the proportional number or weight of each species, according to the units used for $\langle c_i \rangle$ and c_i . Consistent units must be used throughout the analysis, but the principles are the same whether it is the number of individuals or the total weight that is to be estimated.

4.3.3 Weight-length relationships

The abundance is expressed either as the total weight or the number of fish in the stock. When considering the structure of the stock, it is convenient to work with the numbers at each age. However, an assessment of the commercial fishing opportunities would normally be expressed as the weight of stock yield. Consistent units must be used throughout the analysis. Thus if the abundance is required as a weight while the target-strength function is given for individual fish, the latter must be converted to compatible units. This may be done by reference to the weight-length relationship for the species in question.

For a fish of length L , the weight W is variable but the mean relationship is given by an equation of the form:-

$$W = a_f L^{b_f} \quad (33)$$

Where a_f and b_f are constants for one species. Suppose the target-strength of one fish is given as:-

$$TS_n = a_n + b_n \log_{10}(L) \quad (34)$$

The corresponding function TS_w , the target-strength of unit weight of fish has the same form with different constants:-

$$TS_w = a_w + b_w \log_{10}(L) \quad (35)$$

The number of individuals in a unit weight of fish is $(1/W)$, so the constant coefficients are related by the formulae:-

$$a_w = a_n - 10 \log_{10}(a_f) \quad (36)$$

$$b_w = b_n - 10 b_f \quad (37)$$

The weight-length relationship is non-linear. This must be taken into account when estimating the total weight from the numbers in discrete size-classes. Suppose there are n_j individuals in the j 'th class, L_j is the mean length and ΔL is the interval between successive classes. An unbiased estimate of the total weight is:-

$$W_f = a_f \sum_j n_j \frac{(L_j + \Delta L/2)^{b_f+1} - (L_j - \Delta L/2)^{b_f+1}}{(b_f+1)\Delta L} \quad (38)$$

Assuming uniform distribution of lengths in any length class.

4.4 Abundance Estimation

So far the analysis has produced an estimate of the mean density of the insonified fish, for each part of the area surveyed, and for each species considered. The next step is to determine the total abundance in the surveyed area. In section 4.2 we considered the extent to which the observed densities along the cruise track represent the surveyed area as a whole, and established mean values for echo integrator output for each species. In section 4.3 we have described the calculations necessary for converting echo-integrator output to fish densities.

The abundance is calculated independently for each species or category of target for which data have been obtained by partitioning the echo-integrals. The calculations are the same for each species:-

$$Q_i = \sum_{k=1}^n A_k F_i \quad (39)$$

The total biomass for all species is:-

$$Q = \sum_i Q_i \quad (40)$$

The F_i are the mean densities (section 4.3) and A_k are the elements of area that have been selected for spatial averaging in section 4.2. These may be calculated from the shape of an area or measured, depending upon the complexity of the area. The presence of land should be taken into account, possibly by measuring the proportions of land and sea.

4.5 Errors of the estimate

A very important aspect of any measurement is the accuracy and the precision of the estimate. It has been said that an estimate with no indication of accuracy is useless. In sections 4.5 we examine methods for measuring survey sampling error in detail, and in 4.6 and 4.7 briefly outline other sources of error in stock estimates, and provide an intrinsic error analysis.

4.5.1 Spatial sampling errors

The spatial variation of the acoustic observations made during an acoustic survey do not necessarily reflect the spatial variation at a given moment. It is also effected by the time variability during the survey. Diurnal variations are frequently reported. Therefore the spatial variability may be better described by treating day and night observations seperately. Still the effect of larger scale cycles or trends remains. On the other hand when using the survey observations for estimating the precision of the total result, both space and time variability should be incorporated. In this context we consider the spatial sampling error or variance related to spatial sampling as the variance estimated from the variability of samples distributed over the area, even if parts of the variability are likely to be caused by variation in time.

All methods described in sections 4.2.2-4.2.7 and summarised in Table 5 assume independent samples, while most survey data show dependence between neighbouring samples, which means that the variance estimates tend to be biased. Different procedures for reducing this bias are presented, either by combining several neighbouring

samples (ESDUs) to make larger samples (transects or rectangles) or by grouping the samples in strata (including contouring).

Table 7 The main assumptions for data analysis the methods.

Estimation method (section)	Assumptions for unbiased estimation of variance related to spatial sampling
No stratification (4.2.2) each transect one sample each ESDU one sample	The samples are independent estimates of abundance in the total area.
Transects as strata (4.2.3) each ESDU one sample	The samples are independent estimates of within strata abundance. Strata abundance estimates are independent.
Stratif. in blocks (4.2.4)* each transect one sample	
Contouring (4.2.5)	
Stratif. in rectangles (4.2.6) each ESDU one sample each transect one sample	
Multiple or repeated surveys (4.5.1.1)	The surveys give independent estimates of total abundance.
Bootstrapping (4.5.1.2)	Simulated (resampled) estimates are independent. Individual samples (ESDUs or transects) are independent.
Degree of coverage (4.5.1.3)	Empirical precision - effort relationships based on repeated surveys (or resampling of subsets of data) considered representative for a particular survey.
Cluster analysis (4.5.1.4)	Consider each transect as a cluster of sampling elements (ESDUs). Take account of within transect and between transect dependence (correlation).
Ratio estimator (4.5.1.5)	Transect sums are assumed to be independent and identically distributed throughout the survey area.
Transform methods (4.5.1.6)	Independent samples. More efficient variance estimates obtained by transforming data from underlying PDF to Gaussian PDF. Assumes that zero and non-zero values belong to different PDFs, that the PDF is correctly estimated and is stationary.
Geostatistics (4.5.1.7) (4.2.7)	Spatial correlation between samples is taken into account, assuming it only depends on the distance (and direction) between samples. Assumes stationarity.

* Including collapsed strata (Table 5)

The following sections describe, methods to take account of the dependence between samples (geostatistics, cluster analysis), methods to get around the problem by considering repeated estimates, simulated repeated estimates (bootstrapping) or empirical precision effort relationships and transforming methods for more efficient variance estimates. The main assumptions are listed in Table 7.

Table 8 Fractional coefficients of variation (CV) calculated from repeated surveys. DOC is Degree of Coverage' which is the ratio between sailed distance and square root of the area.

Location	Month-year	Size of Area Nm ²	n	DOC	CV	Remarks
Fjellangervåg ¹	Sep-77	0.17	4	6.5	0.18	night
Lindåspollene ¹	Mar-78	1.0	4	8.0	0.39	night
			6	8.0	0.61	day
Sea of Marmara ²	May-72	12.6	4	3.9	0.19	stratified
			4	3.9	0.21	unstratified
Outer Eidfjord ¹	Feb-78	13.1	2	8.2	0.36	night
			3	8.2	0.20	day
	Mar-78	13.1	3	15.5	0.16	night
			4	15.5	0.17	day
Samlafjord ¹	Feb-78	15.6	6	5.0	0.17	night
			2	5.0	0.01	day
	Mar-78	15.6	4	6.8	0.22	night
Nordfjord ¹	Feb-78	21.6	5	11.1	0.16	night
			4	11.1	0.40	day
Eidfjord ¹	Oct-77	25.1	2	5.0	0.68	night
			7	5.0	0.37	day
	Nov-77	25.1	2	10.6	0.12	night
	Jan-78	25.1	4	10.0	0.13	night
			2	10.0	0.51	day
Samlafjord ¹	Jan-78	27.3	4	5.8	0.12	night
Lofoten ³	Mar-71	119	6	9.6	0.30	day+night
Gulf of Oman ⁴	Feb-81	10500	3	4.4	0.15	
	Feb-83	10300	2	5.9	0.27	day+night
Barents Sea ⁵	Oct-74	62540	2	5.5	0.04	
	Oct-75	57250	2	5.3	0.18	day+night
	Oct-76	54210	2	5.3	0.20	day+night
	Oct-77	40590	2	4.7	0.10	day+night
	Oct-78	57600	2	4.9	0.48	day+night

1 Fjords and Fjord inlets in western Norway, Aglen (1983b). 2 Johannessen and Losse (1977). 3 Blindheim and Nakken (1971). 4 Aglen et al. (1982). 5 Gjørseter and Tilseth (1983).

4.5.1.1 Multiple or repeat surveys

A direct way to study the precision of an acoustic survey is to make a number of surveys in the same area at approximately the same time. This can be made by a number of vessels surveying the same area simultaneously (multiple surveys) or with one vessel making repeated surveys. The expected variance for multiple surveys may not be quite equal to the one expected for repeated surveys; Multiple surveys are influenced by differences

between ships, while repeated surveys tend to cover some more variation in time, as more time is needed for making a given number of coverages.

When there are n surveys and Q_i denotes the biomass estimate for the i th survey from Equation 3 the estimated variance of Q is:-

$$Var(Q) = \sum_{i=1}^n (Q_i - \bar{Q})^2 / (n-1) \quad (41)$$

and from Equation 5 the coefficient of variation is:-

$$CV(Q) = \sqrt{Var(Q)} / \bar{Q} = SD(Q) / \bar{Q} \quad (42)$$

where SD is the standard deviation.

An enormous effort is needed to make a sufficient number of surveys in a large area. Therefore most repeated surveys reported are made in small areas. Results from Blindheim and Nakken (1971), Johannesson and Losse (1977), Aglen et al. (1982), Gjørseter and Tilseth (1983) and Aglen (1983b) are summarized in Table 8. The values of the fractional coefficient of variation listed ranges from 0.01 to 0.68, but most of them (22 out of 28 values) are in the range 0.10 to 0.40. All except one of the values outside this range are based on only two surveys. Strømme and Sætersdal (1987) reports surveys repeated once from three different areas at the North West African coast. These results representing quite favourable conditions give coefficients of variation close to 0.03. Their conclusion is that "the results thus show that under favourable conditions carefully conducted surveys can be expected to produce results of relatively high precision".

4.5.1.2 Bootstrap

A second approach to the problem of assessing survey sampling error is the bootstrap technique (Efron and Tibshirani, 1986; Robotham and Castillo, 1990). The observed densities are used to obtain a probability density function is used with a random number generator to produce new sets of simulated data. A cumulative probability distribution is generated from the observed densities y_i :-

$$x = F(y) \quad x_i = (\text{count } y \leq y_i) / n \quad (43)$$

The inverse function is derived:-

$$y = F^{-1}(x) \quad (44)$$

Then a new set of density values y_i may be simulated using a uniform random number generator, samples are selected at random from the original distribution without removal or from the inverse function and added to the new simulated survey:-

$$y_i = F^{-1}(\text{rand}(0 \rightarrow 1)) \quad (45)$$

The total abundance may be estimated as:-

$$Q = \sum_{i=1}^n A_i c_i y_i \quad (46)$$

Where A_i is the area and c_i the integrator conversion factor. Thus multiple surveys may be simulated each with the same PDF. Typically 100 such simulations would be carried out, and the results evaluated as above section 4.5.1.1. More complex resampling regimes may be used in order to obtain data that more closely represents the survey data. For example the data may be organised into groups of consecutive positive and zero values, then first a group is selected randomly and secondly resampled randomly taking the same number of samples found in the group. In this manner the typical runs of zero and non zero values that occurred in the original survey are found in the simulated surveys. Any single zeros in a sequence of positive values may be treated either as a zero group of length one sample or as part of the positive value group. The results from these resampling methods may be compared.

The total abundance Q is estimated for each simulated survey and the mean variance and confidence limits are obtained by the conventional formulas. The central limit theorem may be invoked to justify the use of the student t factor in the calculation of confidence limits, or the data may be tested for normality by a standard statistical test. This technique is simple to carry out and gives a good guide to variability in some situations. Superficially it corresponds well to the results of a real survey. However, we consider that bootstrapping has limited relevance to acoustic surveys. In its simple form it takes no account of the spatial distribution, and each observation is treated as a sample from a stationary PDF. In more complicated resampling regimes some attempt is made to emulate the spatial distribution and the non-stationarity of the data. All the large scale spatial variation due to non stationarity and all the local random variation due to chance encounters are combined and modeled as part the survey variance. The bootstrap method should be used with stationary spatial distributions with no evidence of spatial correlation. In its simple form it is not applicable to surveys of stocks with a non stationary spatial distribution.

4.5.1.3 Degree of coverage

Aglen (1983b) defines "degree of coverage" as sailed distance (N) relative to the square root of the area (A) investigated.

$$DOC = N/\sqrt{A} \quad (47)$$

It is similar to the term "sampling intensity" used by Kimura and Lemberg (1981). The reason for this definition is to have a measure of effort which directly relates to the precision, independent of the size of the area surveyed. Aglen (1989) give more detailed reasoning for this definition and compares it with other measures of effort. He presents an empirical relationship between coefficient of variation (CV) and degree of coverage (DOC) estimated from repeated and partial surveys the relationship is:-

$$CV = a(DOC)^b \quad (48)$$

The resulting values of a are from 0.41 to 0.79 for the different areas and stock distributions. The values of b were are close to -0.5, the value expected when estimating coefficient of variation from the intertransect

variation assuming independent transects. There were no significant differences between small and large areas, but at any given DOC the estimated coefficients of variation differed greatly between different stock surveys. The spatial distribution of the fish may explain a large part of the differences (Gerlotto and Stequert, 1983).

The conclusion is that empirical relationships between coefficient of variation and degree of coverage do not give very good estimates of the coefficient of variation for one single survey. Such relationships are, however, useful as a guide to the amount of effort needed for obtaining a wanted precision. The following thumb rule can be suggested:-

Ideal DOC = $(0.5/(CV))^2$ where CV is the required coefficient of variation.

The results presented by Aglen (1989) indicate that stock estimates from surveys made with a degree of coverage above 6 are close to normally distributed, ie a DOC of 6 is sufficient to correctly invoke the central limit theorem. Thus the assumption of normally distributed survey estimates may be made and confidence intervals estimated.

4.5.1.4 Cluster Analysis

Cluster sampling, as described by Hansen et al (1953), is intended for situations where the sample elements form discrete clusters. The clusters are selected at random and the elements or observations within the clusters form the sample. Cluster sampling is used when simple random sampling would be inefficient and costly (as would be the case if an acoustic survey vessel had to randomly sample 1 Nmile ESDUs in a survey area). In applying this method to acoustic sampling, the analogy is made that the observations along a transect form a cluster.

The cluster sampling approach to abundance estimation in fisheries acoustic surveys was first presented in a paper by Shotton and Dowd (1975). The formulae originally presented in this paper (and again in Shotton (1981) and Shotton and Bazigos (1984)) contain some typographical errors and should be treated with caution. Correct formulae are presented here.

Suppose for transect i y_{ij} is a density observation n_i is the number of observations and y_i is the sum of densities along the transect i , then:-

$$y_i = \sum_{j=1}^{n_i} y_{ij} \quad (49)$$

and the overall mean density is:-

$$\bar{y} = \sum_i y_i / \sum_i n_i \quad (50)$$

Note that this formula for the mean is equivalent to that of a random sample mean - i.e.:-

$$\bar{y} = \sum_i y_i / \sum_i n_i = \sum_{ij} y_{ij} / N \quad (51)$$

$$\text{where } N = \sum_i n_i$$

Statistical sampling texts (Hansen et al, 1953; Kish, 1965) prefer to provide cluster sampling variance formulae in terms of the relative variance V_r^2 , which is the square of the coefficient of variation:-

$$V_r^2 = \text{Var}(\bar{y}) / \bar{y}^2 = (1 - f / t\bar{n}) \hat{V}^2 (1 + \delta(\bar{n} - 1)) \quad (52)$$

where f is the sampling fraction (assumed to be zero because the population size $\gg N$), t is the number of transects in the sample, \bar{n} is the mean number of observations per transect, and δ (delta) is an index of intra-transect correlation. The terms \hat{V}^2 and δ are calculated as:-

$$\delta = \frac{B^2(t-1)/t - \hat{V}^2/\bar{n}}{(\bar{n}-1)\hat{V}^2/\bar{n}} \quad (53)$$

$$\hat{V}^2 = ((t-1)/t) B^2 ((\bar{n}-1)/\bar{n}) W^2 \quad (54)$$

where:-

$$B^2 = \sum_i \frac{(\bar{y}_i - \bar{y}_t)^2}{(t-1)\bar{y}_t^2} + \sum_i \frac{(n_i - \bar{n})^2}{(t-1)\bar{n}^2} - 2 \sum_i \frac{(\bar{y}_i - \bar{y}_t)(n_i - \bar{n})}{(t-1)\bar{y}_t \bar{n}} \quad (55)$$

$$W^2 = \frac{(1 - \bar{y}^2)}{N} \sum_i \frac{n_i}{(n_i - 1)} \sum_j (y_{ij} - \bar{y}_i)^2 \quad (56)$$

Note that \bar{y}_i is the mean density of transect i , and \bar{y}_t is the mean of transect means.

The B^2 term represents the between or inter-transect component of the variance and W^2 the within or intra-transect component. Delta (δ) is an index of intra-transect correlation. If transect means are similar, δ will have a value close to 0 (tending to $-1/(n-1)$). If densities within a transect are alike, δ will have a value close to 1. Thus, δ gives a measure of the heterogeneity between or within clusters. Shotton and Bazigos (1984) suggest that a priori knowledge of the δ value can aid in survey design. With small δ , most of the variation is within transects, so the number of observations per transect should be increased (i.e. transects should be lengthened). If the value of δ is close to 1, most of the variation is between transects, and so a larger number of shorter transects is recommended. Acknowledging that this breakdown into within and between variance components is of value to the survey planner, it is difficult to see how either of the proposed actions could be implemented in a practical sense. Let us assume that our original trackline bounded the geographic distribution of our target species. Lengthening a transect to provide more samples would merely result in collecting more data outside

the range of the fish distribution. Shorter transects are not possible because they would not extend to the limit of the target species' range. Altering the size of the ESDU to create more or fewer samples seems artificial.

Shotton and Dowd (1975) compared three variance estimators and concluded that "only the cluster estimate ... appeared conceptually sound with respect to assumptions on the data." They found that the cluster sampling method was the best available because 1) it accounted for serial correlation among observations from contagious distributions and 2) the results could be used to allocate sampling effort based on the degree of inter- and intra-transect variation (Nakashima 1981). Examples using this methodology and the formulae above are scarce in the literature. Nakashima (1981) and Miller (1985) used cluster sampling techniques to estimate capelin (*Mallotus villosus*) abundance off Newfoundland in the northwest Atlantic. In Nakashima's analyses, he found coefficients of variation ranging from .07 to .55. Miller's results show coefficients of variation ranging from .16 to .36.

4.5.1.5 Ratio estimator

Shotton and Bazigos (1984) note that for transects (clusters) of unequal size (i.e. length), the estimation formulae are equivalent to those of a ratio estimator when densities are first summed for each transect:-

$$\bar{y} = \frac{\sum_i y_i}{\sum_i n_i} \quad (57)$$

and:-

$$Var(\bar{y}) = \frac{t}{N^2(t-1)} \left(\sum_i (y_i - \bar{y})^2 \right) \quad (58)$$

The key phrase here is "first summed for each transect". Serial correlation within transects has no effect since only transect density sums are used in variance estimation. These estimation formulae are equivalent to those proposed by Jolly and Hampton (1990). It was with these simplified formulae that Williamson (1982) demonstrated the suitability of a cluster sampling approach under varying degrees of serial correlation among the individual ESDU's.

Arguments for and against equally-spaced (i.e. systematic) and randomly-spaced parallel transects were presented in sections 3.2.1.4 and 3.2.1.5. Practitioners of this "transect as sample" approach to abundance estimation possess different views regarding transect spacing. Jolly and Hampton (1990) insist that the transects be randomly positioned in the survey area. Williamson (1982) and Francis (1985) contend that in many survey situations the population can be assumed to be randomized with respect to the equally-spaced transects. Francis (1985) also notes that "equal spacing minimises the chance of inter-transect correlation and if spatial variation is smooth produces a more accurate estimate than random surveys."

As with all estimation procedures, the results are only valid when the assumptions of the technique have been satisfied. In applying transect-as-sample approach to fisheries acoustic data, one assumes that the transect sums (clusters) y_i are independent and identically distributed throughout the survey area. (This second assumption describes a condition of stationarity.) Francis (1985) stresses the value of replicate transects to examine the assumptions of stationarity and independence, and the temporal component of variability. Independence of transect means should always be verified. Though serial correlation among elements is no longer of concern now that density data are represented by transect sums, it is still possible that correlation between transects may exist. Johannesson and Mitson (1983) found significant correlation (r at lag 1 = 0.456) between adjacent transects while analyzing data from a 1982 acoustic survey in the Strait of Bali, Indonesia. If the estimated mean and

variance are to be used in constructing confidence intervals for the population abundance, then normality of the transect means should be checked. Jolly and Hampton (1987) invoke the Central Limit Theorem and suggest that, in most cases, the estimated mean and variance for a survey will be approximately normally distributed.

Criticism of the transect-as-sample approach to abundance estimation comes from practitioners of spatial statistics methods. They point out that summing density information along a transect to provide a single transect sum results in a loss of valuable information. Collapsing the data from a transect of densities into a single value inappropriately reduces a two-dimensional situation to one dimension.

4.5.1.6 Transform methods

The probability density function (PDF) of the fish density is often found to be positively skewed, which means that a large proportion of the observations yield small values. This type of PDF is very different from the symmetrical normal or Gaussian probability function on which much of sampling theory is based. If μ is the true mean and σ^2 is the true variance of F , the Gaussian PDF is:-

$$P(F) = \frac{e^{-((F-\mu)/(2\sigma))^2}}{\sqrt{(2\pi\sigma^2)}} \quad (59)$$

For any stationary PDF, the arithmetic average F and the sample variance s^2 calculated from the observations are unbiased estimates of the true mean and variance respectively. But when the PDF is not Gaussian, these estimators although unbiased are not the most precise. They are subject to variation which may be very large. In addition although both the mean and variance have been correctly estimated it will not be possible to estimate confidence limits without some further assumptions about the distribution of the mean value.

More efficient estimators can be derived if the PDF is explicitly known or can be transformed to a known distribution such as the Gaussian PDF. The principle behind this idea is that a new data set is conceived as a one-to-one transformation of the original observations, such that the new PDF is Gaussian. Statistical theory is applied to deduce new estimators for the mean and variance which are more accurate than F and s^2 .

The first step is to determine the appropriate transformation. It is sufficient for practical purposes to consider only the class of power transformations for F^λ in the range 0 to 1. The limiting case $\lambda = 0$ is equivalent to the log-transform $Z_1 = \ln(F_1)$. The most likely value of λ may be determined from a test due to Box and Cox (1964). Estimators for the special cases $\lambda = 0, 1/6, 1/4, 1/3$ and $1/2$ have been described by MacLennan and MacKenzie (1988), see Appendix I. As far as we know, estimators have not been derived for an arbitrary value of λ , but in practice it is good enough to work with those from Appendix I for which λ is closest to the value indicated by the Box-Cox test.

The transform theory assumes that the samples are drawn from a stationary PDF which is zero for $F \leq 0$. Further complications arise when the fish distribution is contagious to the extent that there is a finite probability of observing $F = 0$. Aitchison (1955) and Pennington (1983) have considered this problem. It is supposed that the fish occur in patches with empty water in between, but the density PDF is stationary within each patch. Aitchison's method treats the zero values and the others as samples from different PDFs, and the estimators are modified to take account of the proportion of zeros in the data. The relevant formulae are in Appendix I.

In principle, the transform method should provide the best estimates of mean and variance, those most likely to be closest to the true values. However, the method depends upon a number of requirements. The PDF must be unimodal, the PDF must be known or correctly estimated by the Box-Cox test, zero values should be real zeros due to an absence of fish not randomly occurring occasional measured zeros due to any measurement threshold. If the transform for the wrong PDF is applied, the results will be biased to an uncertain extent. The

contagion which is often a feature of the fish distribution is another practical problem. The transform method is not suitable for contagious distributions unless they conform to the assumptions of Aitchison's technique.

4.5.1.7 Geostatistics

The main part of this section is extracted from the papers of Armstrong, 1990; Gohin, 1985; Petitgas, 1991; Petitgas and Poulard, 1989.

The acoustic samples (ESDU) present two main characteristics:

- an apparently stochastic process, random variability in space.
- a spatially coherent distribution; which allows mapping of density values.

These two characteristics are typical of the "regionalized variable", concept introduced by Matheron (1965). Classical statistics are suitable for stochastic processes but ignore spatial structure, which can result in serious bias in the results. There are some techniques to overcome this problem in the calculation of mean and variance, such as adjustment for autocorrelation in the data (MacLennan and MacKenzie, 1989), or the use of cluster analysis, see section 4.5.1.4. (Williamson, 1982; Robotham and Castillo, 1987). Both of these techniques attempt to eliminate the spatial characteristics of the distribution. In contrast, geostatistics is designed to take advantage of this spatial autocorrelation.

Geostatistics takes into account the regional (spatial) parameter by fitting a model to the data set. The model is used in the analysis, to calculate the mean and spatial variance of the data. Simple geostatistics requires the assumption of stationarity of the distribution. While some geostatistical techniques may be adapted to non-stationary distributions, we will limit the present discussion to the case of stationary data.

The basic tool of geostatistics is the variogram. It is constructed under the following hypothesis. If a regionalized variable has a value Z at a geographical point (x) , then the mean (or expected value) of $Z(x)$ is constant for all points (x) :-

$$E[Z(x)] = m \tag{60}$$

The covariance $C(h)$ between the points (x) and $(x+h)$ is only dependent on the vector h . Thus the hypothesis requires that the mean and the variance of $[Z(x)-Z(x+h)]$ are independent of the point (x) :-

$$E[Z(x)-Z(x+h)] = 0 \tag{61}$$

$$Var[Z(x)-Z(x-h)] = 2\Gamma(h) \tag{62}$$

The function $\Gamma(h)$ is the variogram

A. Properties of the variogram

The variogram is a plot of the variance of $[Z(x)-Z(x+h)]$. We have assumed that the mean of this function is zero, the mean is stationary.

Thus the variogram is the mean square value of the difference between $Z(x)$ and $Z(x+h)$:-

$$\Gamma(h) = \frac{1}{2}E[Z(x)-Z(x-h)]^2 \quad (63)$$

As it is normally applied to $N(h)$ pairs of data points, the variogram takes the following form:-

$$\Gamma(h) = \frac{1}{2N(h)} \sum_{i=1}^{N(h)} [Z(x)-Z(x-h)]^2 \quad (64)$$

In the case of acoustic surveys, the data set is two-dimensional and the vector h can be described in polar coordinates by its modulus h and its orientation.

The variogram is graphically represented by the plot of $\Gamma(h)$ versus h , for a given orientation (figure 22). The value of the variogram is always zero for $h = 0$. A curve may be then fitted to the calculated values of the variogram. It must be modelled by a mathematical function. The most common functions are the power function (with its particular case, linear); the spherical (which is most often used on fisheries data sets), exponential or Gaussian. If there is no structure in the spatial distribution, and the data look purely random, the value of $Z(x)$ does not depend on h . Figure 23 (after Armstrong, 1990) shows some different kinds of curves with their spatial significance. A number of features may be extracted from the variogram.

- i) By comparison between the different variograms obtained for the different orientations of h , we have a description of the anisotropy of the spatial distribution of the data.
- ii) the asymptote of $\Gamma(h)$ with h gives the maximum extension of the autocorrelation of the data, the range.
- iii) the maximum value of $\Gamma(h)$, the sill, gives the variance beyond the local autocorrelation.
- iv) the intercept on the y axis, the nugget effect, representing the sampling variance at a point.

In some cases the variogram is best described by several mathematical functions, which may indicate that several scales of structure exist in the area, for example a small scale structure due to schools and a larger scale structure of the overall density distribution.

The variogram is an excellent descriptive tool, and it may be used for a number of purposes. It can be used to stratify an area using the spatial characteristics of the structure. If different curves fit the variogram in different parts of the area, this may indicate the presence of different ecological populations. Appropriate stratification could then be applied. A practical example of this point is detailed in section 4.2.

The following sections B and C are extracted from Petitgas (1991) and are written after Matheron (1965,71,89).

B) Interpolation

There are two main interpolation methods point and block kriging.

i) Point-Kriging

The point estimate proposed by kriging at an unsampled location x_0 is a weighted average of the sample values

taken at locations x_α :-

$$Z^k(x_o) = \sum_{\alpha} \lambda_{\alpha} Z(x_{\alpha}) \quad (65)$$

The weighting factors λ_{α} depend on the spatial correlation between sample values (i.e. spatial structure) and on their relative locations. The kriging estimator is chosen to be a "best linear unbiased estimator".

In the stationary ergodic case, the mean value at any point is constant and is the same as the mean over the area, $E[Z(x)] = m$, for all x . The unbiased condition requires:-

$$E[Z_o - Z_o^k] = 0 \text{ thus } \sum_{\alpha} \lambda_{\alpha} = 1 \quad (66)$$

The variance is estimated as:-

$$\sigma_k^2 = E[Z_o - Z_o^k]^2 = E[Z_o^2] - 2E[Z_o Z_o^k] + E[Z_o^{k2}] \quad (67)$$

Each term in the above equation can be stated in terms of the covariance which gives:-

$$\sigma_k^2 = \sigma_{\infty} - 2 \sum_{\alpha} \lambda_{\alpha} \sigma_{\alpha o} + \sum_{\alpha} \sum_{\beta} \lambda_{\alpha} \lambda_{\beta} \sigma_{\alpha \beta} \quad (68)$$

where $\sigma_{\alpha o}$ denotes the covariance for the distance $|x_o - x_{\alpha}|$.

The minimisation of the quadratic form (equation 68) under the constraint of equation 66 is performed using the method of Lagrange and leads to a regular linear system where the weights applied to each sample are the unique solution:-

$$\begin{cases} \sum_{\beta} \lambda_{\beta} \sigma_{\alpha \beta} = \sigma_{\alpha o} + \mu \text{ for all } \alpha \\ \sum_{\alpha} \lambda_{\alpha} = 1 \end{cases} \quad (69)$$

and the kriging variance is:

$$\sigma_k^2 = \sigma_{\infty} - \sum_{\alpha} \lambda_{\alpha} \sigma_{\alpha o} + \mu \quad (70)$$

where μ is the Lagrange multiplier and where α, β are the indices of sample pairs and o the index of the point to be estimated. If x_o coincides with one of the x_{α} then μ equals zero and so does σ_k^2 . Kriging is an exact interpolator. The unbiased condition ensures that the estimate is close to the mean in areas that are not well sampled.

ii) Block-Kriging

The mean fish densities in blocks of space may also be estimated. Using the same notations as above. $Z_v(x_o)$

denotes the mean density in block v centred on point x_0 and $Z_v^k(x_0)$ denotes its kriging estimate:-

$$Z_v^k(x_0) = \sum_{\alpha} \lambda_{\alpha} Z(x_{\alpha}) \quad (71)$$

The unbiased condition is the same as equation 66 above and the variance of the estimate is stated in terms of the covariance, following equation 67 as:-

$$\sigma_k^2 = \sigma_{vv} - 2 \sum_{\alpha} \lambda_{\alpha} \sigma_{\alpha v} + \sum_{\alpha} \sum_{\beta} \lambda_{\alpha} \lambda_{\beta} \sigma_{\alpha\beta} \quad (72)$$

where

$\sigma_{\alpha\beta}$ is the covariance for the distance $|x_{\alpha} - x_{\beta}|$

$\sigma_{\alpha v}$ is the mean value of the covariance between point x_{α} and another point x which takes successively all positions in v and is given by:-

$$\sigma_{\alpha v} = \frac{1}{v} \int_v \sigma_{\alpha x} dx \quad (73)$$

and σ_{vv} is the mean value of the covariance between 2 points x and y which takes successively all positions in v and is given by:-

$$\sigma_{vv} = \frac{1}{v^2} \iint_v \sigma_{xy} dx dy \quad (74)$$

The block kriging solution is:-

$$\begin{cases} \sum_{\beta} \lambda_{\beta} \sigma_{\alpha\beta} = \sigma_{\alpha v} + \mu & \text{for all } \alpha \\ \sum_{\alpha} \lambda_{\alpha} = 1 \end{cases} \quad (75)$$

and the kriging variance is:-

$$\sigma_k^2 = \sigma_{vv} - \sum_{\alpha} \lambda_{\alpha} \sigma_{\alpha v} + \mu \quad (76)$$

Comparing equations 69 with 75 and 70 with 76 only the right hand side of the relationships have changed. For point kriging the covariances are calculated with the point x_0 whereas for block kriging the covariances are calculated with all points in v .

Properties of Kriging

In order to solve the above equations we need to know the covariance. When the variance is bounded variance and covariance are related by $\gamma(h) = c(0) - c(h)$. The kriging model is written in terms of the variogram. The

covariance σ is replaced by the $-\gamma$ minus the variogram. If the variogram is unbounded this substitution is not possible. This is important as some data may require the use of spatial models with no variance i.e. an unbounded variogram. When the covariance or the variogram is the sum of at least 2 models (nested structures) it is possible to map only one structural component by omitting the unwanted structure on the right hand side of the kriging relationships. Particularly, one may want to omit the nugget effect to remove purely random effects.

iv) QUASI-STATIONARITY

In this case the kriging estimate is calculated as above, using only the samples in the immediate vicinity of the point or the block to be estimated. This is done by restricting points to those within a neighbourhood window (kriging in a moving neighbourhood). The effect of the unbiased condition is to constrain the estimate to the local mean in the vicinity of the point x_0 . So in practice, a variogram model only needs to be inferred for short distances and can be said to be "local". Typically for fish distributions the variogram may have little meaning at large distances and it may be appropriate to ignore it. A local model is adequate for estimating the total abundance, variance and mapping the area. Moreover, the micro-ergodicity of the variogram is compatible with a non-stationary spatial distribution provided that there is no pronounced trend at a scale at which the local model is inferred i.e. within the neighbourhood domain. In this case the spatial distribution is regarded as quasi-stationary.

C) Abundance estimation

i) Calculation of mean density

If the spatial distribution can be identified as stationary ie. the experimental variogram shows a stable sill, the mean may be estimated by block kriging over the entire area. This procedure is correct only if the sample are clustered or evenly located in space but requires that there is no global bias in the variogram. However, strict stationarity is required, but can rarely be assumed for fish distributions. In addition the experimental variogram is inappropriate at long distances. The quasi-stationary model is much more useful. When regular sampling is used, space may be defined in blocks. The sample or the transect mean can be used as an estimate of the mean of the block. The sample values are used directly to for spatial integration. For instance when the sampling is systematic an arithmetical mean can be used. When the sampling is irregular the total abundance can be derived from the spatial integration of a block kriged map.

ii) Variance calculation

Geostatistics provide formulae for the calculation of the variance of the abundance estimate. Even though the sample locations are independent, if a spatial structure exists, the sample values will be correlated and geostatistics may then be applied.

Systematic sampling

The early geostatistical transitive method was developed for calculating the variance of the total abundance with systematic sampling. The following formulas are given in one dimension. The abundance estimate is:-

$$Q = a \sum_{k=-\infty}^{k=+\infty} Z(x_0 + ka) \quad (77)$$

where $Z(x)$ is the fish density, a the sample spacing and x_0 is the origin of the grid. This formula requires that

the stock spatial structure has been sampled to its boundary. The variance of estimate is:-

$$Var(Q) = a \sum_{n=-\infty}^{n=+\infty} g(na) - \int_{-\infty}^{+\infty} g(h) dh \quad (78)$$

where $g(h)$ is the covariogram:-

$$g(h) = \int_{-\infty}^{+\infty} Z(x)Z(x+h) dx \quad (79)$$

This definition of the covariogram holds even if the fish spatial distribution is non stationary. The variance of the estimate can be calculated because the origin of the grid is random. As the sample locations are stationary on a regular grid the geostatistical transitive formula can be defined. The variance of the estimate is the difference between the integral of the covariogram and its approximation on the sampling grid (equation 78). It is a function of the sample spacing and $g(h)$ which describes the spatial distribution. The closer the samples and the more regular the spatial variations, the more precise will be the estimate. This one dimensional method is appropriate when transects are parallel and equidistant. It can be applied to the one dimensional set obtained by combining all values along a transect to give one value per transect.

In geostatistical intrinsic methods (eg. kriging) the sample locations do not have to be randomized. The sample locations are considered fixed, each sample value is considered as an outcome of a random process. No specific sampling scheme is required, but the hypothesis does require some degree of stationarity in the spatial distribution. Stationarity is either a characteristic of the survey sampling pattern (transitive methods) and the fish spatial distribution may not be stationary. Or stationarity is a characteristic of the fish spatial distribution and no particular sampling regime is required. Matheron (1965,71,89) has shown the link between the two approaches and how they theoretically lead to the same estimates of variance. An application of both methods on North Atlantic herring has confirmed this in practice.

The variance of the estimate calculated by the geostatistical intrinsic method (equation 78) is:-

$$\sigma_{est}^2 = -\gamma(v,v) + 2\gamma(v,n_\alpha) - \gamma(n_\alpha, n_\beta) \quad (80)$$

where:-

$$\begin{aligned} \gamma(v,v) &= \frac{1}{v^2} \iint_v \gamma_{xy} dx dy \\ \gamma(v,n_\alpha) &= \frac{1}{vn} \sum_\alpha \int_v \gamma_{x\alpha} dx \\ \gamma(n_\alpha, n_\beta) &= \frac{1}{n^2} \sum_\alpha \sum_\beta \gamma_{\alpha\beta} \end{aligned} \quad (81)$$

α and β are indices of the sample pairs and n is the number of samples. $\gamma(v,v)$ is the total dispersion of the values in the area within the model. $\gamma(v,n_\alpha)$ is an approximation of $\gamma(v,v)$ of first order due to the fixed position of the samples relative to the geometry of the area and has no equivalent in the transitive formula for

the variance of the estimate. It is required because the sample locations are considered fixed and not random. $\gamma(n_\alpha, n_\beta)$ is an approximation of $\gamma(v, v)$ of second order on the experimental grid itself.

For regular sampling designs, when the sample spacing is smaller than the range of the correlations the general formula (80) can be approximated. This is based on the theory of approximation of integrals by discrete summations. A very important result is that the behaviour of the variogram between the origin and the range contributes the most to the variance of the estimate. A quasi-stationary local model is theoretically sufficient for the computation. A common approximation (Matheron 1971, Journel 1978) is to consider that the errors made in each block of the regular sampling design are independent. This approximation is acceptable when the inter-transect distance is smaller than the range of the spatial correlation. For an equidistant parallel transect design the abundance estimate is:-

$$m = \frac{\sum_i l_i m_i}{\sum_i l_i} = \frac{\sum_i Z_i}{N} \quad (82)$$

where l_i is the length of transect i , m_i is the arithmetic mean of the samples along transect i , Z_i is the i^{th} sample value and N is the total number of samples. The above approximation leads to the following variance of the estimate:-

$$\sigma_{est}^2 = \frac{\sum_i l_i^2 \sigma_i^2}{\sum_i l_i^2} \quad (83)$$

where σ_i^2 is the variance of the estimate of the mean for a rectangle a by l_i using the mean of the transect i (a is the inter-transect distance). The sample variance σ_i^2 is calculated using equation 80. For the estimate of the mean density in a rectangle by its exhaustively sampled middle line, the integrals of the variogram in equation 80 can be solved formally. Journel and Huijbregts (1978) did these calculations for different variogram models and give tables from which the variance of the estimate can be read.

Random Stratified Sampling

For a random stratified sampling regime the abundance estimate is:-

$$m = \sum_i w_i m_i \quad (84)$$

where w_i is the weighting factor and m_i is the mean of the i^{th} strata. The samples are considered as points in space and the geostatistical variance of this estimate is:-

$$\sigma^2 = \sum_i w_i^2 \frac{\sigma^2(o, v_i)}{n_i} \quad (85)$$

where n_i is the number of samples in strata i and $\sigma^2(o, v_i)$ the dispersion variance of one randomly located

sample in v_i , ie it is the variance of the estimate of the mean of v_i by one randomly located sample. The variance of the estimate, from equation 80, from one fixed sample x_α in v_i is:-

$$\sigma_{est}^2 = 2\gamma(v_i, x_\alpha) - \gamma(v_i, v_i) \quad (86)$$

The dispersion variance is the expectation of σ_{est}^2 over all possible locations of x_α in v_i :-

$$\sigma^2(o/v_i) = E[\sigma_{est}^2] = \gamma(v_i, v_i) \quad (87)$$

Here a dispersion variance is used because the sample locations are random within strata v_i . Only the mean value of variogram within the strata contributes to the variance of the estimate.

When this approach is used a quasi-stationary spatial model with a proportional effect, a link between strata mean and strata variance, is often an appropriate representation of spatial distribution. The variogram in strata i is proportional to the mean overall variogram γ_m :-

$$\gamma_i = \frac{s_i^2}{s^2} \gamma_m \quad (88)$$

Where s_i^2 is the sample variance in strata i and s^2 is the sample variance of the full data set. All strata variograms are proportional to a variance scaled variogram $\gamma_o = \gamma_m/s^2$. The variance becomes:-

$$\sigma^2 = \sum_i w_i^2 \frac{s_i^2}{n_i} \sigma_o^2(o/v_i) \quad (89)$$

Where $\sigma_o^2(o/v_i)$ is calculated with γ_o . By including the term σ_o^2 geostatistics includes the within strata spatial structure as part of the variance of the estimate in contrast to classical statistics (Cochran, 1977) which ignores this term.

Heterogeneous sampling

This approach is not recommended. The ship sails on a poorly defined track as far as sampling theory is concerned. However, the track is optimised given the available time and biological information. Heterogeneously sampled data can be mapped by geostatistical intrinsic methods as these do not require a specific sampling regime. However, the variance of the estimate can only be approximated. It may be regarded as a quality criteria for the estimate and geostatistics can help to calculate its order of magnitude. A local stationary model is useful as a block-kriged map can be estimated. The block-kriging variances are not independent as the same samples are generally used in different moving neighbourhoods for the estimation of different blocks. The computation of the cross covariances error terms can get very complicated. Journel (1978) suggests approximations.

The cross covariance error terms can be ignored in some cases, and the kriging variances calculated as if the blocks are independent. The data can be regrouped *a posteriori* and attributed to an area of influence. A variance of estimation can be calculated on the swept area principle. The variance of the estimate is calculated, using equation 80, with each area considered independent. Space can also be divided into regular blocks, independent of the density values. The spatial distribution is interpolated at the nodes of this regular grid. Each estimated value can be treated as it were a sample value. Sample variances can be composed as if in a regular sampling

design. Simulations may also be used.

iv) The importance of the variogram model for small distances.

The variance of the estimate is the difference between integral of the variogram and a discrete approximation on the sampling grid. A mathematical function to describe the variogram is required. In the expression:-

$$\gamma(v,v) = \frac{1}{v^2} \iint_v \gamma_{xy} dx dy \quad (90)$$

All distances are used, even the smallest ones. Between the origin $h=0$ and the first data point on the variogram a model must be chosen, in the absence of data. A nugget effect or a small structure will lead to two different variances for the global estimation. This choice should be based on an understanding of the fish behaviour. Alternatively, some fine scale sampling should be undertaken. A nugget effect is a more random interpretation at small scale therefore less optimistic.

4.5.2 Species allocation error

4.5.2.1 Fishing

The trawl is by far the most common gear used both for identification of echo traces and for making "representative" catches of mixed recordings. Trawl selectivity is a large field of research for gear technologists and ethologists. It is found to depend on fish size, species and physiological and environmental conditions. In many cases it is very sensitive to small details of gear construction and operation of the gear (Main and Sangster 1981 a and b, Ona and Godø 1987, Engås and Godø 1987a and 1987b). The complex nature of trawl selectivity makes it quite variable and difficult to predict. In many cases it is thought to be the main source of error to acoustic estimates split by species and size groups (Hysten et al. 1985).

Gear selectivity always will influence the results when catches are used to split mixed recordings. When catching for identifying single species recordings, the selectivity is less important. There are, however, cases when traces may be misinterpreted due to selective gears. For instance when catching for traces from fast swimming fish, these may totally avoid the gear and another species may by accident appear in the catch. It is important that the person who interprets the echo recordings also observes the whole catching process, thereby collecting all available information for judging the validity of the catch.

The repeatability of trawl catches is not widely studied. Barnes and Bagenal (1951) report a case study on trawl hauls repeated at the same location. They found rather small between-haul variations of the length composition of each species, while the ratios between species were quite variable. The results reported by Engås and Godø (1987b) show the same tendency; repeated trawl hauls indicated "relatively homogeneous" size composition, while the species composition varied considerably. The ratio between the catch rates of cod and haddock showed diurnal variations caused by the fish behaviour.

4.5.2.2 Acoustic species allocation

Species identification by acoustic methods are discussed in section 3.3.3.2, which is a review of promising methods reported. None of these methods are yet widely used during echo integration surveys. In the context of errors to typical echo integrator surveys the term "acoustic species allocation" is therefore given a different meaning; Species allocation based on acoustic information available during a typical echo integration survey (the procedures described in section 4.1.1).

Quantitative studies on the precision of partitioning echo integrals are scarce in the literature. Mathisen et al.(1974) report the results of four different teams evaluating the same echograms independently. Sixteen echograms covering a wide range of values were examined. The average value (over the 16 intervals) allocated to fish by each team ranged from 197 to 268, those allocated to plankton ranged from 860 to 945, while those allocated to other sources (mainly contributions from bottom echoes) ranged from 131 to 161.

A common attitude is to be cautious about overestimating fish densities. -Some scientists may not want to allocate values to the target species (or fish in general) unless they are well above 50% sure. This means they are likely to underestimate fish abundance. During some Scottish herring surveys the fish values have been allocated to "herring", "probable herring" and "probably not herring". The best estimate of herring has been based on the sum of "herring" and "probable herring". If "probable herring" had not been taken into account, the herring estimate would for the worst year would decrease by as much as 40% (Simmonds et al. 1986 and 1987, Kirkegaard et al.1989 and 1990)

4.5.3 Effect of fish behaviour

The ethological reactions of the fish may be spontaneous (migrations, diurnal changes in structures, etc) or induced by the perturbations due to the survey vessel. Although the visible result in terms of echo reception is the same (changes in the availability of the fish, problems of echo attenuation or in the mean individual TS), the consequences on the survey design are different. Each case is examined separately.

4.5.3.1 Effect of spontaneous behaviour

A) Migrations

We define here a migration as a large horizontal movement within the time scale of the survey.

The principal consequence of migrations is to change the availability of the stock to an acoustic survey, if moving into inaccessible areas (shallow waters, foreign territorial waters, none navigable areas, etc).

There are two sources of bias, either in estimating the area A occupied by the population or the mean density F_A . The data obtained on the survey comes from an area A_s and the estimated density is F_s

- the estimation of A : if the area is not covering completely, underestimates of population may occur. One way to avoid this problem is for instance to obtain prior or simultaneous information on A through the fishery (Vilhjalmsson, 1987; Vilhjalmsson et al, 1983)

- the estimation of F_A : the estimator of density obtained is supposed equal to the actual density of the total area A . If this is not the case (i.e. if A is not completely sampled and the population distribution is not homogeneous), then the simple assimilation of A to A_s and F_A to F_s is not valid.

An other kind of bias may appear, due to the fact that the population is moving during the survey. This is especially important when the survey is performed in two stages, or when comparing data collected on the same point at two different periods. A second bias risk, due to the fact that the population is moving while surveyed, is that it may be overestimated if the movement is in the same direction as the survey (and A exhaustively covered), or underestimated when the movement is in the opposite sense. Practically very few solutions exist for correcting this point (except the former knowledge of the stock behaviour, section 3.2.1.1).

MacLennan and Simmonds (1991) describes the magnitude of the problem : if v_f and v_s are the migrating speed of the fish and the speed of progress of the survey in the direction of the migration.

Then the observed densities F_s are unbiased but the estimate $E[Q]$ of total biomass Q is biased due to incorrect assessment of the area A (not applicable for continuous stocks that extend beyond the survey area):-

$$E[Q] = Q(1 + v_f/v_s) \quad (91)$$

The authors give the example of a coastal survey with along shore migration, which is one of the most common cases. If transect length is 5 times the transect spacing, a vessel moving at 10 knots (5 m/s) would progress at 2 knots with or against the migration, if migration rate is, for instance, 0.5 knots (Harden Jones, 1968). Then the error would be:-

$$E[Q] = Q^* (1 + 0.5/2) = + 25 \% \text{ (with)}$$

$$E[Q] = Q^* (1 - 0.5/2) = - 25 \% \text{ (against)}$$

If the transects are arranged with or against the direction of the migration, the combined bias is:-

$$E[Q] = Q(1 - (v_f/v_s)^2) \quad (92)$$

(always underestimating), then, considering the practical case of an "interlaced" survey with two sets of transects, one with and one against the migration direction at twice the spacing ($v_f=0.5$ and $v_s=4$), they obtain:-

$$E[Q] = Q[1 - (0.5/4)] = Q^* (1 - 1/64) = -1.6 \%$$

This kind of "interlaced" survey can cause other problems, for example the fact that if the stock is migrating along the maximal anisotropy direction, the transects would be parallel to that direction and the density data extremely sensible to a slight movement of the bulk of the biomass in a perpendicular direction. As usual the choice of that kind of grid will depend on what is assumed to be the most important error risk. When there is not enough information on the behaviour of the fish, the safest way should be to avoid planning a survey at the time the stock is moving.

The method developed by the scientists from Iceland (Reynisson, pers. comm.) to deal with this problem on the capelin stock is probably the most complete. It consists in:

- abandoning any idea of random sampling;
- adjusting the inter transect distance according to the stock density distribution;
- shifting the area under study according to the observed distribution of the capelin (information from the fishery and previous survey or an outline survey by scouting vessels);
- if possible, performing the survey during the periods when changes in distribution due to migration or behaviour are at a minimum;
- repeating the survey during the stable period, in order to get an indication of the precision of the estimate.

This example shows clearly three constraints that the study of a migratory stock present, (a) a very good knowledge of the migration pattern, (b) the adaptation of the survey method to the observed migration and (c) the inapplicability of some statistical methods for evaluating the precision of the estimate thus requiring alternative methods.

B) Effect of circadian changes

These changes in the behaviour along a 24 hours cycle may have various effects:

- displacement of a part of the total biomass through unaccessible areas (near surface, near bottom, shore areas...). This case will be detailed in the next section;
- changes in the structure of the aggregations which has consequences on the results of acoustic evaluation, due either to the characteristics of the structures, or to their variability.
- changes of target strength (TS) may occur as a result of compression/expansion of swimbladder during diurnal vertical migrations

i) Characteristics of the structures

They can be divided in 3 types: scattered, scattering layers, schools.

- scattered. In this case, by definition, the fishes are separated enough one to the other to give individual traces on the echogram. If they are numerous, there is usually no error on their evaluation. But when they are scarce, an error may appear: the use of a 20 log R function supposes that the decrease of the individual echoes is compensated by an increase of the sampled volume (Burchynsky, 1982). When the fish density is low and the fish are small some fish occurring on the edges of the beam will be below the sampling threshold. This problem is a problem for both fish counting and echo integration, in both cases the sampling volume must be known.

- scattering layers (aggregations). The fish are much more numerous in this case, and it becomes difficult or impossible to count them on the echogram. Nevertheless they do not present a coherent structure. From an acoustical point of view, it tends to be some time overlap between individual fish echoes, but there is still no multiple scattering within the fish aggregation. This kind of distribution is typically that for which echo-integration has been developed and there is bias due to such a distribution. The only other noticeable error risk concerns the presence of plankton layers in the same depth interval as the fish concentration (see section 4.1).

- schools. The great majority of the pelagic species on which echo-integration is applied, are in schools during the day. This kind of structure has several important sources of bias. A good description of schooling behaviour is given in Radakov (1973).

The first important point concerns the internal structure of the schools. Many works have been published on this topic, from tank experiments as well as field observations. Some models have been proposed, which consider a school as a "crystal-like" structure, with regularly spaced fish, as for instance the "diamond structure" proposed by Weihs (1973), where the fish are distributed in such a way that they may take advantage of the hydrological movements of the water induced by their neighbours. The author calculated a theoretical distance of 0.2 to 0.7 body length between the fishes. Breder (1976) proposes a more complex 3 dimensions model from the same hydrological hypothesis. The results of tank observations give different results. Partridge and Pitcher (1979) show that observed fish do not present the 0.3 theoretical best inter individual distance, but a 0.9 body length distance that would not allow to benefit of hydrological effects.

When processing the results of field observations, it is clear that the models proposed are not often confirmed in situ. A summary of published data is presented in Table 9. From that table one can see that the fish densities inside schools are divided in two main groups: (1) most observations give densities less than 3kg per cubic meter (in the order of 1 to 100 fish per m³, depending on the fish size), and (2) some observations of a density of more than 5 kg/m³ (in the order of 100 to 3000 fish per m³, depending on fish size), principally herring in advanced maturity and anchovies.

Table 9. Summary of observed or measured school densities for several species as presented in the literature.

Species	Author	Inter-fish spacing	Length (cm)	Weight (g)	Density (No m ⁻³)	Density (kg m ⁻³)	Experimental conditions
Poll.v.	1	1.14 1.27 1.15 0.99 1.07 0.95	27.1 27.1 27.1 27.1 31.7 31.7				t.p
Gad.m. Cl.h.		0.63 0.71	48.5				t.p t.p
Tr.j. En.j.	2	1.43 7.8 12.0	20.0	100	6.6-19.5 0.25 0.85	0.7-2.0 0.005	s.p s.p
Sc.sp.		1.51	16.0	50			s.p
Am.l.	3	0.45 0.34					t.p
Et.t. En.j.	4	10	8				s.p s.p
En.m.	5	1.2			115	1.3	s.p
Ma.v.	6	5.7					s.p
Cl.h.	7					0.7-2.5	s.ei
Cl.h.	8				2-5		s.ei
Cl.h.	9				0.5-1		s.ei
Cl.h.	10					0.2-0.8 (pre-sp) 30-32 (spawn)	
Cl.h.	11				10-15	0.5-0.75	s.p
Sc.sc. Gad.m. Ma.v.	13	3.2 3.2 10					
Hg.Pac.	14					0.004-30	s.a.p
En.m.	15	0.2-0.5	12	11	800-3000	8.8-33	calc.
En.m.	16		12		50-75	0.8	t.
En.m.	17		12		650		
Sl.a.	18		24?	225?	0-50 20	0-11 4.5	s.ei.
tt.pel.	19					0.67 day 0.27 night	s.ei. s.ei.
O.s. Sc.sp.	20		16.3 20.2	37.8 90.5	7-119 4-67	0.24-4.5 .33-6.0	calc. calc.
Cl.h.	21		26.6	126	.008-.79	.001-1	
Cl.h.	22				.05-.25	.006-.03	
Cl.h.	23				0.6	0.075	
Cl.h.	24		19.5 19.5	50 50	100-140 150-160	5-7 7.5-8	S.a. S.p.

Species	Author	Inter-fish spacing	Length (cm)	Weight (g)	Density (No m ⁻³)	Density (kg m ⁻³)	Experimental conditions
Cl.h.	25		29.5	188	0.8	0.15	s.p.
tt.pl.	26					0.2-1.0	s.a.
Cl.h.	27		32.9		47.5		s.a.

Bibliographic sources:

- 1 : PARTRIDGE et PITCHER, 1979 2 : AOKI et al., 1986
3 : PITCHER et WYCHE, 1983 4 : AOKI et INAGAKI, 1988
5 : GRAVES, 1976 6 : SEREBROV, 1984
7 : WALSH et ARMSTRONG, 1985 8 : AASEN, 1955
9 : TRUSKANOV et SHERBINO, 1962 10 : YUDOVICH, 1953
11 : OLSEN, 1987 12 : GLASS et al., 1986
13 : ROSE et LEGGET, 1988 14 : MULLIGAN et al., 1987
15 : VAN HOLST et HUNTER, 1970 16 : MAIS, 1974
17 : DAVIES, 1973 18 : ELMINOWICZ, 19XX
19 : GERLOTTO et al., 1976 20 : BAZIGOS, 1978
21 : SHOTTON, 1983 22 : TRUSKANOV et ZAPHERMAN, 1977
23 : SEREBROV, 1976 24 : OLSEN, 1985
25 : BUERKLE, 1987 26 : MISUND et al., 1991
27 : TORESEN, 1991

Species:

Poll.: *Pollachius virens*; Gad.m. : *Gadus morrhua*; Cl.h.: *Clupea harengus*; Tr.j.: *Trachurus japonicus*; En.j.: *Engraulis japonicus*; Sc.sp.: *Scomber sp.*; Am.l.: *Ammodytes lanceolatus*; Et.t.: *Etrumeus teres*; En.m.: *Engraulis mordax*; Ma.v.: *Mallotus villosus*; Sc.sc.: *Scomber scombrus*; Hg.pac.: pacific herring; Sl.a.: *Sardinella aurita*; tt.pel.: various pelagic species; O.s.: oil sardine.

Experimental conditions method:

v: tank; p: photo/film; s: "in situ"; ei: echo-integration; a: acoustics; calc: calculation.

These differences between the models and observed results may be due to the high heterogeneity of densities inside a school. It has been observed that a school presents high and low density areas, including vacuoles without any fish (Cushing, 1977). An example of such a structure is given by Gerlotto and Freon (1988) for *Sardinella aurita* (figure 24). This variability of density distribution inside the schools is probably species dependent, as suggested by Misund and Aglen (1989). Rose and Legget (1988) take advantage of these variations of the inner density to discriminate between 4 species (see section 3.3.3.2)

Considering this heterogeneous school structure, Gerlotto and Freon (1988) have calculated that for low-density schools gives negligible bias at the usual vessel speed and number of sounding per second.

A more serious error risk it that of "acoustic shadowing", which may cause large errors in case of dense schools. The common school densities reported in Table 9 are not likely to cause serious shadowing at least when the vertical school extension is moderate (say less than 30 m). This phenomenon is further discussed in section 4.6.2.3.

Changes of the structures

Many species show a regular pattern of forming schools by day and scattered distributions by night. This kind

of transformation is not universal and that some species may retain the same structure; others may change or not due to the moon light, bioluminescence, or other natural parameters. A good description and analysis of this kind of behaviour has been presented by Azzali et al (1985), through the use of catastrophe modelling. The authors consider three groups, schools, aggregations and scattered. They show that a day-school has not the same biological meaning that a night -school of the same species in the same area.

Changes in tilt angle

A more serious problem is the change of the mean tilt angle of the fish. This angle is usually small and homogeneous by day, high and variable by night. This has been pointed out in almost all the observations published: Buerkle (1983) obtains a mean angle of -3° by day (head downwards) and $+12^\circ$ by night, for herring *in situ* observations. He (1988), Wardle and He (1988) show that for mackerel in tanks the tilt angle is also higher by night than by day. Aoki and Inagaki (1988) give for the japanese anchovy (*Engraulis japonica*) similar results: -3° by day and $+11^\circ$ by night (*in situ*). When observed in cage, the results are more contradictory: MacLennan et al (1989) show a very small variation of tilt angle between day and night for herring (0.8°) and mackerel (3°). Other authors have observed a variation of the angle more similar to that observed *in situ* or in tanks: Edwards and Armstrong (1983) have measured a difference of -5 dB in the TS values between day and night for herring, Gerlotto (1987) a difference of -7 dB for *Sardinella aurita*, which could reasonably correspond to a change in the tilt angle of about 12° .

Changes in depth and depth adaptation

In addition to changes in tilt angle fish may migrate between different depths between day and night. For swimbladdered fish the bladder will be expanded or compressed after the change in depth. For some species gas will be replenished or absorbed over periods of many hours in others where gas cannot be secreted it will slowly diffuse through the swimbladder wall under pressure. This subject is extensively reviewed by Blaxter and Batty 1990.

Summary

These changes have several consequences for the survey estimates:

- changes in the mean tilt angle may change individual echoes by day or night;
- changes in depth due to diurnal migration may change TS by day or night;
- the packing density induces an acoustic shadow inside the schools and thus a lower total echo energy by day;
- Dispersed fish may not be detected due to threshold effects;
- the availability to the survey vessel may vary: often the fish are more available by night than by day, which makes the total biomass observed by night higher than by day;
- avoidance reactions to the vessel too makes the fish less available by day.

Depending on the behaviour of the population the survey should be designed in different ways according to the aims of the research; the most used are the following:

(a) single survey grid including day and night data (Bazigos, 1981; Lamboeuf et al, 1983): a single correction factor is calculated between the day and night results and applied if necessary.

(b) single day or (more often) single night grid, the other half of the 24 hours being used for other purposes (fishing, hydrology, etc..) (Massé, 1988).

(c) double survey grid, by day and by night, the data being processed separately (Gerlotto, 1989).

The method (a) allows to have a high degree of coverage, which is a benefit (Aglen, 1983b; 1989). In contrast

the introduction of a day/night correction factor may input an important bias: it has been shown that the day/night relationship may change during a survey, according to various criteria, such as difference in the species composition in different sectors of the surveyed area, the difference in moon lighting along the survey, etc... When keeping in mind the fact that there is no overlapping of day and night observations, in case of heterogeneous distributions the transformation index may be highly biased.

The method (b) is the worst in terms of the amount of information that can be extracted during a limited time; its justifications are usually due to the behaviour of the population (as presence of plankton by night, as in Massé, 1988) or external constraints (such as crew availability for fishing operations, share time with other research, etc..).

The method (c) is time consuming, as each transect is repeated twice; it may present biases in case the stock is migrating during the survey. Nevertheless, it provides the largest number of comparable day night observations. Often the night data are used for biomass evaluation and the day data serve to correct these evaluations, to discriminate the different species in case of mixed species distributions, etc...

C) The effects of fish found near boundaries.

The evaluation of the part of the biomass close to the boundaries of the area studied, i.e. near the surface, the bottom, or the coastal (not navigable) areas, presents three kinds of problems: acoustical, ethological and statistical.

Acoustical. Close to the bottom there is an acoustic blind zone. This is caused by two effects first if a part of a fish echo overlaps in time with the bottom echo it cannot be detected separately this occurs with a half pulse length in range from the sea bed. Secondly the spherically shaped wavefront of the pulse will add to blind zone away from the centre of the beam. When the bottom is not horizontal (slopes), effects of echoes from the side of the acoustic beam increase the blind zone. A correction has been published by Johannesson and Mitson (1983) giving the equation for calculating the height h of the blind zone:-

$$h = d(1 - \cos(\theta/2)) + c\tau/2 \quad (93)$$

where d is the total depth, $c\tau$ the pulse length and θ the angle of the beam. This equation give the distance from the bottom where the whole fish echo can be separated from the bottom echo. Theoretically the fish echo can be detected and even partly integrated at shorter distance from the bottom. Some recently developed equipment allow measurements closer than the height of the blind zone, principally multibeam echo sounders and wide band systems using pulse compression.

Close to the surface, the blind zone comes from three phenomena: first the depth of immersion of the transducer, secondly the transducer characteristics : when the transducer is emitting it cannot receive, which makes an area impossible to observe. Practically the efficient minimum distance from the transducer corresponds to the beginning of the time varied gain (TVG) working area. When adding to these points the problem of the echoes of the air bubbles, Johannesson and Mitson (1983) give a rough evaluation of the minimum distance below the transducer, which is twice the wave height plus half the pulse length. Another problem in shallow zones is the impact of the lateral lobes: their strength is normally weak enough to be considered as negligible, but close to the transducer they can add a rather important sampled volume. It is also important to check whether the lateral lobes do not lead to significant echoes from the hull of the boat, or an echo from the back of the transducer from the surface.

Ethological. We shall see later the importance of the avoidance behaviour on the results. It is evident that this

behaviour is extremely important close to the boat, and results in a decrease of the observed number of echoes (lateral avoidance) and a decrease of the individual TS (increase of the tilt angle, see Olsen et al., 1983)

Statistical. In the vertical dimension, the evaluation of the part of the biomass in the blind zones has been described by Bazigos (1981) : the method consists of drawing the vertical profile of the biomass distribution and extrapolating the curves in the blind zones. This method assumes that the avoidance behaviour is known in shallow areas, and that the demersal fish have the same behaviour and distribution as the populations above them. In the horizontal dimension, specially in shallow waters, the extrapolation of the biomass to unavailable areas (not navigable, forbidden, etc) is the best method available, extrapolation should take into account other information of fish behaviour.

4.5.3.2 Effect of the reactions of the fish to a survey vessel

The reactions of the fish to the presence of a survey vessel have been first pointed out in the pioneering work of Olsen (1971). In a synthesis of their observations, Olsen et al (1983a; 1983b) show that the avoidance reaction of the fish by night could be extremely important, as up to 80 % of the actual biomass could escape the observer. Nevertheless some contrasting results were presented in the same time, where the avoidance reactions were considered not significant (Halldorsson and Reynisson, 1983). These contradictions show that avoidance is not a consistent phenomena, and that a number of parameters may induce this behaviour. Each situation may have to be studied separately.

A) Day reactions

Reactions at large distance from the vessel are thought to be due to the noise of the vessel because light cannot propagate over such distances. Neproshin (1979) shows that a school detected with a sonar at distances between 200 and 800 m in front of the route of the boat reacts more or less intensively depending on the speed of the vessel (i. e. noise level) and on the hour of the day : at low speeds or at 01:00 - 03:00 pm, the escape reaction appears at about 20 m in front of the boat, and at high speed at other moments of the day, at up to 100 m. Aglen (1985), then Misund and Aglen (1989) show that an important proportion of the schools (from 16 to 41 %) may avoid the vessel route. This proportion would depend also on the fish length. Diner and Massé (1987) observe the same phenomenon, which they relate to the hour of the day and to hydrological conditions. Gerlotto et al (1989) show that the fish may react to artificial sounds by vertical as well as horizontal escape movements during large periods (more than 24 h). Goncharov et al (1989) observe an avoidance behaviour of schools of jack mackerel which change the direction their route to 30 to 60°, giving from 35 % to 65 % of the school biomass unobserved. Boklach (1989) measured a threshold distance to the boat of about 160 m for horse mackerel, sardine and mackerel: an important part (not evaluated) of the schools remained further than that distance from the vessel. Gerlotto and Freon (1988a) suggest that the schools situated in front of the vessel are "trapped" in the low noise cone due to the masking of the propeller noise by the hull in the route axis, and do not escape laterally easily. Aglen and Misund (1990) present identical results and observe that the horizontal speed of the school is modified by the approach of a boat.

- reaction below the boat. The only works on this subject concern the behaviour of schools observed by echosounder. This particular behaviour presents three characteristics: vertical position of the school in the water column; changes in the inner structure; individual position of the fish inside the school. Gerlotto and Freon (1988b) show that the gravity centre of the schools of *Sardinella aurita* in Venezuela dive moderately (around 5 m) in the upper layers (0 to 20 m), and do not change their depth in deeper layers. The upper parts of the schools react more than the lower parts, and the school is compacted in its upper layers (figure 24). Finally the authors measure the diving angle of the fish according to the horizontal and vertical speeds, and estimate that in their surveys the fish dives at an angle less than -10°. Aglen and Misund (1990) show that in case of herring and mackerel schools the behaviour looks rather similar (moderate diving, with the upper parts of the school diving slightly more than the lower parts);

B) Night reactions

An important experiment conducted by Olsen (1979), who quantified the decrease of the fish density at the precise moment of the passing of the vessel. Olsen et al (1983a) present a model of this behaviour, which may be responsible of a decrease of up to 80 % of the actual biomass. Their model presents the noise of the propeller as explicative stimulus. Nevertheless contradictory results have shown that such an hypothesis was probably not sufficient. Halldorsson and Reynisson (1983) do not observe any change in the TS distribution (i. e. in the diving behaviour) depending on the noise alone. Aglen and Misund (1990), report the behavioral reactions of the fish in front of a survey vessel "may be more complex than the model presented by Olsen et al (1983a)". It is thus necessary to separate the studies of the effects of the two principal stimuli, the noise and the light. Other causes have to be taken into consideration. Olsen and Ahlquist (1989) show through the use of survey results as well as experimental observations that the mean TS may dramatically decrease with the depth. The hypothesis they give are the following: fish behaviour (diving), depth adaptation (swimbladder volume), physiological conditions. They conclude that a "behavioral parameter" is required in the equation of the TS.

Effect of the noise It is difficult to study the effect of the noise alone. As far as we know, two works have been published. Freon et al (1990) compare the echoes of fish below a boat using alternately sails and motor. Their results show that the noise alone seems to have no noticeable effect on the fish distribution by night. Ona and Toresen (1988) using a towed scanning sonar do not see any change of the fish distribution below a non lighted ship. These observations confirm those of Halldorsson and Reynisson (1983).

Effect of the light The lights of a vessel produce a considerable reaction of the fish, as observed a long time ago by Richardson (1952). This reaction may be limited to a fast change of vertical position in the water column without change in the total biomass (Levenez et al, 1987). In some cases, the fish disappear almost completely (Ona and Toresen, 1988), as pointed out by Olsen et al (1983b). It may finally consist in a change of the mean TS and escapement of a small part of the population (Gerlotto et al, 1990).

The global balance of these reactions show that the avoidance reactions of the fish depend on a complex scheme and may vary dramatically depending on the intensity of the different stimuli. They depend also on the biological condition of the fish, which react differently to the same stimulus with relation of the external natural parameters. Two main conclusions have to be taken in consideration, as far as the survey design is concerned.

(1). The visual stimuli are much more important than any other. It is essential to keep control of the light conditions of the vessel during the survey. Usually a survey vessel has no fore lights on during the night, for evident security reasons (visibility at the upper deck), but very often the lateral and stern lights are not taken into consideration and depend on the crew necessities (particularly after fishing operations). These lights may have a dramatic impact on the density measurements.

(2). The change of the stimulus is also important: the fish react much more to a variation of the stimulus than to its absolute intensity. That explains why the noise, which is perceived at large distances, induces a moderate reaction while the light, and moreover the view of the hull, very close and sudden, may be highly disturbing. It is thus extremely important to avoid any brusque change of the noise level of the ship. for instance, avoiding as much as possible the starting or the stopping of a motor, and above all of acoustic equipments, which, whatever their nominal frequencies, may emit low frequency waves perceptible to the fish. From this point of view, the sonar is a very noisy equipment, and it must be used with care during a vertical echo sounding survey.

Finally, all these observations have to be taken into consideration also in the case of the reactions of the fish to a fishing gear. See the works of Wardle, Glass and Wardle, Ona, Suuronen, Misund, Aglen, Dalen.

4.6 Additional errors

4.6.1 Equipment

Foote et al. (1987) describe procedures for calibrating echo sounders and discuss the errors. They show that calibration with a suitable standard sphere properly positioned on acoustic axis gives a precise estimates of the on axis sensitivity. A precision of + 0.2 dB ($\pm 5\%$) is quite realistic (Foote 1982b, Foote and MacLennan 1984). Strictly this estimate only represents the range where the sphere is measured. Deviations from the nominal values of the time-varied-gain function will make the errors range dependent. Methods for frequent measurements of those deviations and automatic compensations have been developed (Simmonds et al. 1984, Knudsen 1985). Calibrations with standard spheres have shown that well maintained equipment usually keeps the performance within ± 0.5 dB for several years. This suggests that the typical variations during a survey are well within ± 0.5 dB.

The on axis sensitivity is not sufficient to define the total transmit and receive sensitivity of an echo sounder. An additional parameter, the solid angle ψ (the equivalent beam angle) must be known. The transducer manufacturer usually supplies a nominal value of ψ , and the transducer is usually not measured later. Simmonds (1984a) has measured a number of transducers. He obtained values which in some cases differed by as much as 0.8 dB from the manufacturer's value. Simmonds (1984b) showed that ψ might depend on the mounting of the transducer. Methods for measuring ψ after mounting are reported (Ona and Vestnes 1985, Reynisson 1985). Variations of the hydrographical conditions close to the transducer may cause small variations of ψ . According to Urick (1975) ψ is approximately proportional to the square of the sound speed. Thus a change in temperature from 5 to 15°C causes about 5% increase in ψ . Foote (1987a) presents calculated values of ψ as function of hydrographical conditions.

When applying the ψ defined from the transducer directivity pattern alone, there is an implicit assumption that each target contributes according to its position in the beam. During echo integration it is usual to apply a threshold to minimize the contributions from noise. This threshold represents a limitation to how far out in the beam a single target is allowed to contribute to the integrator value. Then the effective part of the beam is a function of performance of the equipment, threshold voltage, target strength and volume density of targets. Lassen (1986), Ona (1987b) and Foote (1988) use the term "effective equivalent beam angle" when discussing this dependence. Aglen (1983a) considers the loss of integrator contributions due to the threshold. The conclusion is that threshold-induced errors are negligible if the threshold is low enough to allow the smallest targets to contribute throughout the most important part of the beam. If this is not the case, the loss might become serious. The results presented by Aglen (1983a) include cases when more than 90% of the echo energy is lost due to the threshold.

The target strength and volume density tend to vary within each transmission and the effective equivalent beam angle (or loss due to threshold) is difficult to estimate. The maximum error introduced by using the theoretical ψ can be calculated by assuming a minimum target strength in a case when all fish are acoustically resolved as single fish.

4.6.2 Transmission losses

4.6.2.1 Temperature and Salinity variation

The time-varied-gain function of scientific echo-sounders performs an automatic compensation for a fixed level of sound attenuation, while the real attenuation varies with the hydrographic conditions. Large deviations from the assumed attenuation will cause significant errors in echo integrator outputs. These errors tend to increase with the range from the transducer. Simmonds and Forbes (1980) have calculated such errors expected for a given equipment in a given area during the seasons. They found that the errors seldom exceeded 0.2 dB at depths less than 200 m. Foote (1981) illustrates the possibility that large errors exist, and Hagström et al. (1985)

and Aglen et al. (1982) report cases when large corrections of integrator values (up to 40%) were required to compensate for such errors.

For most areas there are sufficient hydrographic data to take such errors into account. There are, however, some uncertainties about the estimation of the true attenuation. Several authors have derived relationships of attenuation as function of sound frequency, temperature, salinity and pressure. There are some discrepancies between the relationships reported (Foote 1981), and some of them are based on observations with large variance. Do and Surti (1982) claim that the estimated attenuation coefficients from some relationships may have an uncertainty of more than 20%. Foote et al. (1987) recommend the formula given by Francois and Garrison (1982) which is reported to have an accuracy of 5%. The impact on estimates of fish density is strongly frequency and range dependant, Foote 1981 presents a study of the magnitude of these errors.

4.6.2.2 Bubbles

Air bubbles in the surface layer occur as a result of wind and waves. This leads to additional attenuation of the sound (Medwin 1974, Dalen and Løvik 1981). This might be very variable and cause serious errors. In bad cases it is common to reject the observations or wait for better weather. One way to reduce this error is to tow the transducer below the layer where the air bubble concentrations are highest. Berg et al. (1983) describe a method to estimate the attenuation in air bubbles from measurements of volume reverberation. Some results from R/V "G.O.Sars" are shown in figure 26 from Dalen and Løvik (1981). It shows large differences between different frequencies. At 38 kHz an attenuation of 3 dB is estimated at 22 knot wind force.

In cases of unfavourable hull construction or transducer location, air bubbles may be brought down from the surface to the transducer even in calm weather. Then the air bubbles may be too close to the transducer to be recorded on the echogram, and the resulting errors may not be discovered.

4.6.2.3 Fish

Several measurements have been made on attenuation of sound by fish (Røttingen 1976, Johannesson and Vilchez 1981, Furusawa et al. 1982, Foote 1990, Toresen 1990). The attenuation depends on the extinction cross section of the fish, the volume density and its vertical distribution. The phenomenon is theoretically discussed by Foote (1978 and 1982a), Yudanov and Kalikhman (1981), Lytle and Maxwell (1982), and MacLennan and Forbes (1984). From Røttingen's results, Foote (1978, 1982, 1983) proposed a mathematical formulation for that phenomenon, according to 2 types of density: scattered fish (no extinction effect), and dense layers. Lytle and Maxwell (1978, 1983) have presented a mathematical model built by assimilation of acoustic phenomena to optical laws. They define the "optical density" as proportional to the density in number of fish and to the vertical extend of the concentration. They present 3 cases, on scattered fish, low-density schools and high density schools. It is important to note that these authors consider a school as dense when the actual density is higher than 110 fish (140 g each) per cubic meter, which is much higher than the usual *in situ* densities (except herring). Armstrong et al (1989) using cage experiment observe that at a frequency of 38 kHz, a school of 10 m height and density of 10 fish of 20-30 cm per cubic meter is underestimated around 35 %. The first *in situ* observation, from Olsen (1985; 1986) explores the attenuation effect of a dense herring school (100-140 fish/m³) on the echo of a steel calibration sphere; the author shows that the attenuation effect becomes serious after a height of the school of 10 metres. Olsen (1987) presents a correction factor applied on Foote's (1983) equation, and gives some correction curves (figure 26). In the case of a rather dense herring school (10-20 fish/m³), his correction factor would be of about 0.15 dB/m. Finally Foote (1990) presents a later version of his formula using the mean backscattering cross-section and the mean extinction cross section.

Toresen, 1991 studied the absorption of acoustic energy in herring schools by echo integration of the bottom signal under various densities of herring. Practically the method consists in splitting the herring school in horizontal layers that are assumed to be homogeneous. The relationship between the bottom echo and the school

density is calculated, according to the model developed by the author, then a correction factor is obtained for each layer. The estimated correction factors correspond to an average attenuation in the order of 0.03 to 0.05 dB/m depth, which means less than 1 dB attenuation in the upper 20 m of the school. The volume densities in these schools were in the range 1-2 fish/m³ (about 0.5 kg/m³). According to Table 9 this density seems rather common and one could expect the observed school attenuation to be rather typical.

Most fish schools are usually not thicker than 20-30 m in vertical dimension (at least tropical species), which means that this extinction effect is not so important: using this bottom echo attenuation characteristic as a rule of thumb (as proposed by Olsen, 1982), we have calculated that the correction to be applied on the *Sardinella aurita* schools in Senegal as well as in Venezuela were not higher than 2 % of the estimated school biomass.

All attenuation errors are very dependent on the survey conditions (hydrography, school density and wind). The sea water attenuation may bias the fish density estimates upwards or downwards. Attenuation by fish and air bubbles always lead to under-estimates. The latter ones are likely to be the largest. Therefore the total effect of attenuation errors is likely to be underestimation.

4.6.3 Transducer motion

The equivalent ideal beam angle ψ treated in section 4.6.1 is an important parameter for estimating the "Instrument constant" (Foote et al. 1987) used for converting integrator data to "acoustic densities". The common definition of equivalent beam angle requires that the position or orientation of the transducer is fixed in the period between transmission and reception of echoes. If the transducer is moving or rotating, the echoes will arrive to the transducer at a changed angle which means a changed directivity. For individual targets such motions may occasionally result in increased echo integrals, but the average effect will always be a reduction in echo integrator values.

Stanton (1982) has calculated the deviations from the static case as function of angular change between transmission and reception. His results are shown in Figure 27. As can be expected the deviation increases with increasing angular change and with increasing beam directivity (decreasing beamwidth). When considering a rolling or pitching transducer, the expected effect at one particular transmission will depend on roll or pitch period and amplitude, transducer orientation at transmitting moment and depth. Stanton gives a realistic example where targets at 400 m depth is underestimated by 64% when observed with 5 degree beamwidth.

The speed of the vessel will also result in an angular change. The distance (d) sailed between transmission and reception of an echo can be expressed in terms of the resulting angular change $\Delta\alpha$. It can also be expressed in terms of the time lag (Δt) between transmission and reception:-

$$d = R \tan(\Delta\alpha) = v\Delta t = v2R/c \quad (94)$$

where R is the range to the target and c is the sound velocity. It follows that:-

$$\tan(\Delta\alpha) = 2v/c \quad (95)$$

which means that the angular change (and the effect on the integrator values) caused by the vessel speed is independent of the depth. A common vessel speed of 12 knots causes an angular change of 0.47 degrees, which according to Figure 27 gives a negligible reduction of integrator values for beamwidths at or above 5 degrees. For very narrow beams (less than 2 degrees) it will, however, become important at this vessel speed.

The conclusion is that common amplitudes of pitch and roll will introduce significant errors when using fairly

narrow beamed (less than 10 degrees), unstabilized, hull mounted transducers. This errors can be effectively reduced by use of stabilized transducers, either on a stable towed body or on a stabilized platform on the ships hull.

4.6.4 Noise and reverberation

Contributions from noise are normally reduced by setting a threshold well above the average level of the received noise and the self-noise of the instruments. The sensitivity of the recorder is usually adjusted to correspond to this threshold. Therefore, if the noise increases above the threshold, it is recorded on the echogram, and the operator is aware that the integrator values have to be corrected. Normally those corrections are small. Often no corrections are made for the part of the noise that overlaps integrated fish echoes. This might introduce significant errors in cases of low signal-to-noise ratio.

Nunnallee (1987) recommends that instead of thresholding out the noise, it should be measured and subtracted from the total integrals. He also describes a method showing promising results.

Weak echoes originating from plankton, air bubbles, sand or mud are in sonar terminology called reverberation and is usually considered as a kind of noise. In the context of echo sounding / echo integration such signals may be treated as noise when they are at the same level as the ambient noise, but usually such echoes are treated separately as described in section 4.1.1.

4.6.5 Target Strength (Backscattering cross section)

This section is not intended as a full discussion of the subject of fish target strength merely brief review of the major sources of error. When discussing errors of fish densities estimated from integrated echo intensities, it is more useful to refer to backscattering cross section, since this is linearly related to the integrator value. The relationship between target strength and acoustic cross section is given by:-

$$TS = 10\log(\sigma/4\pi) \quad (96)$$

The target strength depends on echo sounder frequency, fish species, fish size and orientation of the fish. A number of measurements of target strength as function of these parameters have been performed (Midttun and Hoff 1962, McCartney and Stubbs 1971, Love 1971, Nakken and Olsen 1977, Buerkle and Sreedharan 1981, Furusawa et al. 1982). For some species there are strong indications that depth, fat content, maturity stage and stomach content also influences the target strength (Brawn 1969, Halldorsson 1983, Blaxter and Batty 1984, Ona 1984 and 1987a and Olsen 1987).

When working with common echo sounder frequencies, the orientation of the fish relative to the horizontal plane (the tilt angle) is the greatest potential source of variations in target strength. Figure 28 shows a typical directivity pattern of a 20 cm herring at 120 kHz. In some cases the target strength variations measured during a full rotation of an individual fish is more than 40 dB, which means that the ratio between extreme values of backscattering cross section exceeds 10 000 (Foote and Nakken 1978). A tilt angle change of 10 degrees might change the cross section by a factor of 100, a change similar to that caused by a tenfold change in fish length. The average cross section of a fish aggregation covering a range of tilt angles is less sensitive to the average tilt angle. Foote (1987c) has calculated average cross section as function of average tilt angle when the tilt angle distribution is assumed normal with a standard deviation of 5 degrees. The results show that a 10 degree change of average tilt angle typically causes

a change in cross section by a factor of 2 or 3. These calculations consider measured target strength data on some clupeoids and gadoids at 38 kHz.

Compared to fish orientation fish size has less impact on the backscattering cross section. Generally it is proportional to the square of the fish length (Love 1977, Foote 1987b). If fish weight increases by the third power of length, the cross section per unit fish weight is inversely proportional to fish length.

The reported target strength measurements show between-species variations of the same order as many of the within-species variations. Many swimbladder bearing species are therefore considered to have similar backscattering cross sections. There is a tendency that some physostomous species (with "open" swimbladder) have a lower backscattering cross section than the physoclists (with "closed" swimbladder) (Foote et al. 1986, Foote 1987b, Olsen 1987). This may be caused by lacking or poorly developed gas-producing organ among some physostomous species (Blaxter and Tytler 1978). Species without a swimbladder are observed to have 4 to 10 times lower backscattering cross section than species with (Edwards et al. 1984, Foote 1980).

There are strong doubts that all fish is able to keep constant swimbladder volume. Particular physostomous fish and fish making extended vertical migrations are likely to have decreasing swimbladder volume with depth (Blaxter and Tytler 1978, Alexander 1972). In addition fat content, stomach content and gonad size are observed to influence the volume and shape of the swimbladder (Ona 1982, 1984 and 1987a). Ona found that an increase of fat content from 10 to 25 per cent was correlated with a 55% decrease of the swimbladder volume in herring. He also shows examples where full stomach and large gonads reduced the swimbladder volume to 1/3 of the normal size. The observed changes in swimbladder shape makes it very difficult to calculate the changes in backscattering cross section corresponding to changes in swimbladder volume. In case of isometric volume changes, the physical cross section will be proportional to the volume raised to the power 2/3.

To cover all the mentioned possible situations, it would be necessary to have frequent measurements of backscattering cross section during surveys. However, simple functions only depending on species and length are applied in most surveys. The biases introduced through this procedure are highly dependent on the situation. Most of the functions in use are either based on in situ measurements of acoustically resolved single fishes or on measurements of aggregations of fish in a cage. Such measurements are in some cases combined with results obtained on anaesthetized, tethered single fish to give better estimates of the size dependence of the cross section. Various in situ methods are reviewed by Ehrenberg (1983a). Examples of applications of in situ methods are given in Ehrenberg (1974), Midttun and Nakken (1977), Halldorsson and Reynisson (1983), Lindem (1983), Robinson (1983), Traynor and Williamson (1983) Degnbol et al. (1985) and Foote et al. (1986).

Descriptions and applications of the cage calibration method are given by Johannesson and Losse (1977), Aglen et al. (1981), Edwards and Armstrong (1983).

Possible errors of in situ methods are discussed by Ehrenberg and Lytle (1977) and Ehrenberg (1983b). Errors in cage measurements are discussed by Burczynski (1982). When these methods are carefully applied, the estimates of average backscattering cross section as a function of species and length might be unbiased and have a reasonably good precision (say + 20%). The crucial question is, however, to what extent such functions represents the survey situation. A cage is an artificial environment for wild fishes. The size of the cage, the packing density of fish, light conditions and currents are factors which might influence the behaviour and thereby the backscattering cross section of the fish. In particular if the fish is influenced by the passage of a survey vessel, the average cross section during surveys is likely to be quite different from the average during cage measurements. By nature an in situ measurement represents a survey situation, but it does not necessarily represent all survey situations. A weakness of the in situ methods mentioned above is that they are limited to low volume densities of fish. They require that the fish are acoustically resolved as single fishes, which might have a tilt angle distribution and backscattering cross section different from fish in schools.

Comparisons of echo integrator values and fish densities estimated from catches can be used to estimate average backscattering cross sections. This method might be applied to both high and low fish densities. The main uncertainty is the efficiency of the fishing gears. Hagström and Røttingen (1982) and Misund and Øvredal

(1988) report measurements based on purse seine catches of herring. Their results are not very different from the results from the in situ measurements summarized by Foote (1987b).

When using empirical functions to estimate average cross section for a mixed group of fish, additional errors are introduced through the estimation of the species and length composition. When the composition in trawl hauls is used directly, the patchiness of species and size groups and the selectivity of the trawl may introduce errors.

4.7 Summary

The total error of the abundance estimate can be considered as the combination of several individual errors whose magnitudes are known or may be calculated on reasonable assumptions. The many factors which contribute individual errors have been discussed in Sections 4.5 and 4.6. These errors are considered in two groups; first those that pertain to both the estimate of abundance and to measures of relative change in stock size. Secondly those that effect absolute abundance only. We summarise these factors and indicate how much error might be expected under the conditions typically encountered on an acoustic survey. All the following is based on the assumption that the survey has been well designed and competently conducted with properly calibrated scientific instruments.

Each factor contributes an error which is either random, systematic or both. The distinction has been explained in Section 2.2. The random errors effect the precision of an estimate and may be reduced by collecting more samples which means spending more time on the survey. This is not true of the systematic errors which bias all the observations equally.

To calculate the total error of the estimate, we must first determine the individual errors. First the abundance estimate is corrected for any known bias. Thus, the individual errors are considered as random variables each of which has an associated PDF, assumed to be Gaussian, with a mean of zero. Most of them are statistically independent. There is no reason to suppose, for example, that fish behaviour should have any bearing on the equipment performance. If some factors are correlated they require special treatment. In fact, the only correlation which needs to be considered is that between the transducer motion and the bubble attenuation, since the associated errors are uni-directional biases which increase in magnitude as the weather gets worse. In this analysis it is assumed that attempts have been made to correct for these biases and the residual error is bi-directional, but the two effects are still considered to be correlated as the residual errors are also likley to be correlated. There may also be correlation between some of the behavioral errors. These are currently, poorly understood and, therefore, we have assumed independence. The errors within any set of correlated parameters are summed and the result is treated as one independent error in the subsequent analysis.

We express the individual errors as percentages. There is a simple formula for the total error which is valid if the error is small relative to the estimate. While some of these errors may not be small, the more complicated theory required to deal with large but uncertain errors is unlikely to improve the validity the overall estimate of error. If ϵ_i^2 is the expected value of the variance of the proportional error, and these errors are independent, the variance of the estimate is:-

$$\hat{V} = Q^2 \sum_{i=1}^n \epsilon_i^2 \quad (97)$$

TABLE 10. Sources of error in acoustic estimates of relative abundance. The figures are an indication of the errors which might occur under typical survey conditions using a 38kHz echo sounder and where appropriate attempting to correct for the known sources of error.

Source of error	Random Error	Systematic Error (Bias)	Notes
Physical Calibration	2%	5%	
Transducer Motion	-	0 to 10%	(1)
Bubble Attenuation	-	0 to 10%	(1)
Hydrographic Conditions	2% to 5%	-	(2)
Target Strength	5%	-	
Species Identification	-	0 to 20%	
Spatial Sampling	10% to 25%	-	
Fish Migration	-	0 to 5%	
Diel Behaviour	0 to 10%	-	(3)
Totals	12% to 28%	5% to 29%	(4)
Over all Total	13% to 40%		
Typical Precision	26%		

Notes:

- (1) Worst in bad weather
- (2) Worst at long range
- (3) Only random if time of day is ignored
- (4) Assuming independent errors for all parameters except for transducer motion and bubble attenuation which may be correlated and are therefore treated as dependant errors.

4.7.1 Error of an acoustic index

On occasions it may be difficult to estimate the absolute abundance of a fish stock. For example target strength information may be limited. However for fisheries management purposes an index of abundance may be used to estimate changes in stock from year to year or season to season. While this may not be much help in deciding on an investment policy in a new area, it may allow an existing fishery to be monitored adequately. Table 10 shows the sources of uncertainty that effect the overall error in the relative estimate. These estimates of error can be compared with the estimates of relative abundance obtained by repeat survey (section 4.5.1.1) and estimates derived from degree of coverage parameter (section 4.5.1.3). In producing these estimates of error we are assuming that the survey is conducted competently and that care has been taken to ensure that where possible the sources of error have been identified and some attempt has been made to minimise these. It is important to note that in some cases where weather conditions have been ignored, inappropriate fishing gear has been used or major migration has been ignored in the survey design, the values shown here may underestimate the true errors. The numerical values for each phenomena are obtained as follows; physical calibration from Simmonds 1990 and Foote 1987, transducer motion from Simmonds and Forbes 1980 and Stanton 1982, bubble attenuation from Dalen and Løvik 1981 and Novarini and Bruno 1982, hydrographic influences from Simmonds and Forbes 1980 and Foote 1981, target strength from Foote 1987, Spatial sampling see section 4.5.1 Fish migration and diel behaviour see section 4.5.3.

4.7.2 Error of absolute abundance estimates

Table 11 shows additional the sources of error that effect the estimate of absolute abundance, the approach to errors described in section 4.7.1 has been applied for these values. The uncertainty of overall abundance is dominated by uncertainty in the absolute value of target strength appropriate for the survey. In the best conditions it should be possible to estimate the absolute abundance in an area to an accuracy of better than $\pm 13\%$ or in the worst conditions $\pm 57\%$. However, conditions are rarely ideal, nor do all the problems conspire together to occur at the same time, and realistically relative estimates should lie in the region of $\pm 26\%$ and absolute estimates $\pm 35\%$

TABLE 11. Systematic sources of error in acoustic estimates of absolute abundance. These figures are additional to those in table 10.

Physical Calibration	3%
Hydrographic Conditions	0 to 5%
Target Strength	0 to 40%
Avoidance reactions	uncertain
Totals including Precision	13% to 57%
<u>Typical Accuracy</u>	<u>35%</u>

5 DISCUSSION

Throughout this document we have described the procedures used to obtain abundance estimates. We have discussed sources of error and shown how they combine, in this last section we present some illustrations with particular surveys and compare the results of acoustic surveys with results from other methods.

5.1 Comparison between stock types

We consider a small number of abundance surveys to illustrate some important characteristics of fish stocks and compare a number of different survey designs and methods of analysis. These studies are not intended to be a comprehensive assessment of the methods applied but are only illustrative of some differences in approach required by the differences in the types of distribution being studied. The particular stock surveys have been selected to illustrate the range of distributional problems and the methods chosen to survey them.

First we look at the mixed small pelagic stocks found in the South China Sea (Anon 1987). This stock is typical of a number of tropical fisheries. This stock appears to consist of small schools of a few hundred kilograms, with ten to twenty different species found throughout the area. Overall abundance appears to vary only slightly within two overall strata. The density in the off-shelf area with water depths greater than 200m is very low. Considerably higher densities are found on the shelf. Here the two strata are surveyed at different sampling intensities. Data from the two strata are analysed separately. The seabed is almost featureless with slowly shelving bottom on the shelf followed by a rapid fall at the shelf edge to 1000m or more. The mean density of spatial distribution within each strata appears almost uniform or only slowly changing and the small schools are encountered randomly on the scale of the survey grid. Here transects are evenly placed in the centre of transect intervals to give the most efficient estimate of the mean density, and the randomness of the fish distribution is assumed. The edges of the area are selected on the basis of national exploitation zones, no distributional changes are anticipated, the transect ends are placed 1/2 transect spacing from the area boundary. In contrast the between strata boundary on the edge of the shelf is deliberately placed on a sharp gradient, the transects are run to the strata boundary and data from between transect track is neglected. A track design can be seen in figure 29. A further feature of this design is that a considerable proportion of time is allocated to fishing in order to estimate the relative abundance of each species.

Next we consider the survey for North Sea Herring carried out in July (Kirkegaard et al, 1990). Here in the western edge of the area the fish are distributed in a mixture of large and small schools. These shoals disperse at night and mix with rather dense plankton layers. During this period the fish become indistinguishable from the plankton and the survey data are not used. Survey is limited to 20 hours per day. There is some evidence that the fish distribution is related to the water depth. Historically high and low densities have been associated with some parts of the area. Data from earlier years is used to define two levels of sampling. The survey transects positions have been located randomly either within the central 80% of each 15 or 7.5Nm interval or with a systematic spacing with a single random starting point. Here although the local variance due to the highly clustered spatial distribution is high, worries about the relationship between fixed features on the seabed and a geographically fixed survey grid require some randomness in the survey design (figure 30).

Jolly and Hampton 1990 surveying anchovy off South Africa choose a number of strata based on the previous years data and place parallel transects in random locations. A two pass adaptive approach is used where a proportion of the time is left unallocated during the first pass. This time is used to provide additional random transects based on the densities observed during the first stratified survey. Thus the final sampling intensity in any one year is based both on the observations from the previous year and for the first pass on the actual year of survey. The positions of all transects are located randomly within strata. It is important that the stock distribution is relatively immobile. Dense concentrations detected one year should be in similar locations the following year, and significant proportions of the concentrations should not move between strata during the period of the survey.

In contrast to these stocks the Icelandic Capelin require a more adaptive approach. Vilhjalmsson 1983 describes the behaviour of the stock. The location of the stock may change considerably from year to year. Information from environmental conditions and the fishing fleet are used to define the general area. A basic uniform systematic grid is combined with areas with closer spaced transects once the areas of high density are determined. The transects are terminated in areas of very low density or at the boundaries of land to the south and ice to the north. An adaptive strategy is required because the majority of the stock may occupy only 20% of the total area. However the location of these high density areas is unpredictable.

A further example of stocks where adaptive strategies have been chosen is given by the fjord surveys for herring. These are conducted in summer for Icelandic spawning herring or in spring for over-wintering Norwegian herring stocks. The stocks concentrate in large schools which occupy a small proportion of the total area. For best results the schools are located by a simple survey of the whole fjord and the stock is estimated by a separate survey of each large school. The boundaries of the survey area are defined by the edges of the fjord and the location of each school. Often a zig-zag grid is chosen, and the transect spacing may be similar to the transect length. This maximises the useful data because there are no inter-transect section that must be removed, and reduces hazardous navigation near the fjord walls.

5.2 Comparison with other methods

The ultimate test of the acoustic survey technique is to compare estimates of the same stock obtained by acoustic and other methods. Suppose that methods A and B give the abundance estimates Q_a and Q_b with variances V_a and V_b respectively. The variances may be unknown, but the differences $(Q_a - Q_b)$ incorporate the combined error of both methods. If the errors are independent, the variance of $(Q_a - Q_b)$ is $V = V_a + V_b$. Given two series of comparable abundance measurements, from annual surveys of the same stock conducted over several years for example, V is estimated as the sample variance of $(Q_a - Q_b)$. The simple comparison does not indicate which method is more accurate, but the variance is a positive quantity and so V is an upper bound on the variances of both Q_a and Q_b .

An early example is given in Pauly et al 1987 who have carried out a virtual population analysis (VPA), a retrospective method based on the catches taken in the fishery (Gulland, 1983), on the Peruvian anchoveta (*Engralis ringens*) covering 1953 to 1981. From 1975 to 1979 acoustics surveys were compared to the results

of the VPA. These results are reproduced in Table 12. There are considerable differences in the two methods. Both track the same trends, however both are based on limited data with major uncertainties. It is difficult to draw clear conclusions from this study. It should perhaps be remembered that since 1979 considerable improvements in calibration and survey practice of acoustic surveys have been achieved, however, fundamental improvements in VPA have been limited.

Table 12 Comparison of Acoustic and VPA estimates of Peruvian Anchoveta (after Pauly et al 1985)

Date	Acoustic Estimate	VPA Estimate
Aug 75	3.39	1.61
Sep 75	4.27	3.61
Jan 76	7.41	4.26
Aug 76	4.62	4.42
Feb 77	1.89	1.00
Jul 77	1.39	0.99
Jun 78	3.78	4.36
Nov 78	2.02	3.25
Apr 79	2.15	1.76

A more successful comparison from better data was made by Jakobsson (1983) who compared acoustic abundances of the Icelandic summer spawning herring against estimates from (VPA). He found good agreement, but the comparison was not strictly valid because the acoustic data had been used to "tune" the VPA, so that the most recent VPA and acoustic estimates were not completely independent. Nakken and Ulltang (1983) conducted a similar study of cod and haddock in the north east Arctic. In this case the VPA and acoustic estimates were independent. When the cod and haddock were considered as one stock, the estimates agreed within 10%, but much larger differences were found in the results for each species. The problem appeared to be due to the trawl catches which did not reflect the true proportion of cod and haddock in the sea.

In fresh water environments, it is often possible to count the run of migrating fish. Nunnallee (1983) has compared the count of sockeye salmon *Oncorhynchus nerka* observed passing a weir, against the population indicated by acoustic surveys of Cultus Lake in British Columbia. The acoustic estimates were obtained by a combination of echo-counting and echo-integration, surveying only at night when the juvenile sockeye were distributed in the upper part of the water column, mainly at depths 20-25 m. Several other species were present in the lake, but they did not migrate, so the sockeye population was estimated from the change in the acoustic abundance after the start of the sockeye run. The weir-count and the acoustic abundance differed by only 2.5%, much less than the 95% confidence interval suggested by intrinsic error analysis. Another approach is comparison with the fish densities indicated by trawl samples. Thorne (1983) has discussed the accuracy of acoustic surveys of salmonid populations in North American lakes. He obtained independent abundance estimates from the catches of a large midwater trawl towed at night. The acoustic estimates were made by echo-integration using either 105 or 120 kHz echosounders, giving 19 valid comparisons of juvenile sockeye salmon populations. Regression of the acoustic and trawl estimates showed a systematic difference of 4%, and a correlation coefficient of 0.73 which indicated a random sampling error of somewhat greater magnitude.

Bailey and Simmonds (1990) have compared the abundance of North Sea herring predicted by four methods - acoustic survey, the larval abundance index, the larval production index and VPA. When several independent measures of the same stock are available, the comparison should reveal any substantial difference in the accuracy of each method. Bailey and Simmonds found that the acoustic estimate was superior to either of those based on larval sampling. In a series of five annual surveys, there were differences around 10% between concurrent acoustic and larval estimates of the stock. This result refers only to the random sampling error, since the larval

indices do not provide absolute estimates of the spawning stock until they are calibrated against absolute estimates obtained by some other method.

Although it is not often that two assessment methods give satisfactory results for the same stock, the comparisons which have been made suggest that in many cases the acoustic technique is at least as good and probably better than any other. Furthermore, the sources of error in acoustic abundance estimates have been more extensively investigated than appears to be the case for other methods, at least as regards the assessment of pelagic stocks in the sea. The most poorly understood errors are those related to fish behaviour and the partitioning of the echo-integrals between species. These errors apply to the absolute abundance estimates, but in a well-designed series of surveys, they should not be important in the precision of the acoustic survey as an index. Again, the index may be converted to an absolute abundance by calibration against any independent measure of the stock which is considered to be reliable enough.

All survey techniques have their own advantages and disadvantages what is important is that the sources of error in any method should be well enough understood to judge the best approach to the problem of fish stock assessment. The acoustic survey has become well established as a useful technique in fishery research. There are many applications in which it is the only practical means of assessment available to fishery managers, but there are others in which no one method is satisfactory. Sometimes we have no choice but to apply different methods in parallel, to produce a final result whose confidence interval is acceptably small.

6 CONCLUSIONS

It is a difficult task to summarise all the different and important points addressed in this document. However, some general conclusions can be drawn. The choice of cruise track and analytical method are closely coupled and must be based on a knowledge of the stock distribution in the survey area. There is no one optimum combination of survey grid and spatial averaging method applicable to all stocks, or survey areas. There is no safe solution, free from assumptions, which may be justified as theoretically the best method. The best method will be found by understanding the nature of the fish stock and survey area and choosing the most appropriate solution. Tables 2, 6 and 7 are provided as a guide for this purpose. From the wide range of stocks and surveys that have been reviewed it is clear that random spatial distribution of pelagic stocks on the scale of transect spacing is a commonly acceptable assumption and thus a systematic parallel survey grid is preferred. The major exception to this is for narrow shelf or fjord areas where the parallel grid is logistically wasteful and may be replaced by a carefully designed zig-zag grid. In cases where the stock distribution cannot be assumed to be randomly distributed, local random positioning of parallel transects is required. For highly contagious distributions adaptive sampling may be preferred in the absence of significant stock migration during the survey.

The assumptions implicit in the choice of survey design lead to different analytical approaches to spatial averaging. The four most useful are a) stratification in rectangles, b) contouring using ecological and density data, c) geostatistics, and d) using transects as samples. Stratification of the survey area both for survey effort and for analysis may give considerable benefits as most stocks exhibit some statistically non-stationarity in their distributions.

Estimation of sampling error in the chosen spatial averaging technique imposes even more assumptions on the data. The samples from an acoustic survey are by their very nature not independent. Some approaches to variance estimation, geostatistics and cluster analysis, make use of this characteristic. Alternatively, rectangular strata or the ratio estimator aggregate data to avoid this problem. Others, such as contour strata, based on density dependent criteria, or some adaptive survey designs, preclude any analysis of precision. The applicability of the numerical estimates of precision depend fundamentally on the validity of the assumptions inherent in each method. It is unclear at present how these assumptions might be tested in practice. The best guide to the magnitude of sampling error is given by the results of repeat surveys and analyses of subsets of survey data.

Table 8 and the Degree of coverage parameter in section 4.5.1.3 give some indication of the range of typical values and limit the estimates of precision to approximately of a factor of two.

Sampling error is only one source of error in the estimate of abundance, other sources such as inaccuracy in calibration, fish target strength and species separation must also be considered. The error analysis in section 4.7 provides neither an optimistic nor pessimistic interpretation of the state of knowledge, and provides one of the clearest statements of the sources of error of any stock estimation technique in fisheries science. From this it can be seen that for highly mobile multispecies stocks located near boundaries the prospects are not good, but for predominantly single species stocks located in midwater the estimates of abundance may be very precise.

7 REFERENCES

Aglen A. 1983a. Echo integration threshold and fish density distribution. FAO fish. Rep. 300 : 35-44

Aglen A. 1983b. Random errors of acoustic fish abundance estimates in relation to the survey grid density applied. FAO Fish. Rep. 300, 293-298.

Aglen A. 1989. Empirical results on precision effort relationships for acoustic surveys. Int. Coun. Explor. Sea CM 1989/B:30, 28pp, (mimeo).

Aglen A. and Misund O.A. 1990. Swimming behaviour of fish schools in the North Sea during acoustic surveying and pelagic sampling trawling. ICES C.M. 1990/B:38, Sess. R, 8p.

Aglen A., Hagström O. and N. Haakansson N. 1981. Target strength measurements and C-value determinations of live Skagerrak herring and cod. ICES CM 1981/B:12 (Mimeo).

Aglen A., Gjørøster J., Myrseth B. and Tilseth S. 1982. Surveys on mesopelagic fish resources in the Gulf of Oman and the Gulf of Aden Jul-Aug 1979 and Jan-Feb 1981. Reports on Surveys with the R/V "Dr. Fridtjof Nansen", Institute of Marine Research, Bergen.

Aitchison J. 1955. On the distribution of a positive random variable having a discrete probability mass at the origin. J. Am. Stat. Soc. 50, 901-908.

Alexander R. McN. 1972. The energetics of vertical migration by fishes. Symp.Soc.Expl.Biol.26: 273-294.

Anon 1987. Deep-sea fisheries resources survey within the Malaysian EEZ. Vol 2 Book 1&2

Aoki I. and Inagaki T. 1988. Photographic observations on the behaviour of japanese anchovy *Engraulis japonica* at night in the sea. Mar. Ecol. Prog. Ser., 43 : 213-221

Aoki I., Inagaki T. and Le Van Long 1986. Measurement of the three dimensional structure of free swimming pelagic fish schools in a natural environment. Bull. Jap. Soc. Sci. Fish., 52 (12) : 2069-2077.

Armstrong M. 1990. Overview of geostatistics. Comm. ICES Work. Group on spatial statistics, Brest, April, 1990. : 8 p

Armstrong M. Renard D. and Berthou P. 1989. Applying geostatistics to the estimation of a population of bivalves. ICES C.M. 1989/K:37 Sess. U :23p.

Azzali M. 1982. Regarding the possibility of relating echo signals features to classes of marine organisms: tests carried out in the north and middle Adriatic Sea. Contrib. 23, Symp. Fish. Acoustics, Bergen, 21-24 June, 1982.

- Azzali M., Buracchi G., Conti S., Gambetti S., and Luna M., 1985. Relationship between the forms of pelagic fish distribution and nycthemeral periods. A tentative model of behaviour. ICES FAST W.G., Tromsø, 22-24 May 1985 : 26p.
- Bailey R.S. and Simmonds E.J., 1990. The use of acoustic surveys in the assessment of North Sea herring stocks and a comparison with other methods. Rapp. P.-v. Reun. Cons. int. Explor. Mer 189
- Barbieri M.-A., 1981. Variabilité des données acoustiques utilisées dans l'évaluation des biomasses halieutiques parécho-intégration. Thèse Doct. 3ème Cycle, Univ. Bretagne Occ., No 133, fév. 1981 :197 pp
- Barnes H. and Bagenal T.B., 1951. A statistical study of variability in catch obtained by short repeated trawls taken over an inshore ground. Jour.Mar.Biol.Assn.,N.S., vol.29:649-660.
- Bazigos G.P. 1974. Applied fisheries statistics. Fisheries Technical Paper No. 135. Food and Agriculture Organisation, Rome.
- Bazigos G. P., 1975. The statistical efficiency of echo surveys with special reference to lake Tanganyika. FAO Fish. Tech. Paper, No 139, april 1975:43 pp
- Bazigos G.P. 1981. A manual on acoustic surveys: sampling methods. Interregional fisheries development and management programme, Rep. CECAF/ECAF ser. 80/17 (En). Food and Agriculture Organisation, Rome, 137pp.
- Berg T., Løvik A. and J. Dalen J. 1983. Increased precision of echo integrator recordings under various weather conditions. FAO Fish.Rep.,(300):45-51.
- Bjornoe L. and Kjaergaard N. 1986. Broadband acoustical scattering by individual fish. Associated Symp. on Underwater Acoustics, 12th Int. Congress of Acoust., Halifax, Canada
- Blaxter J.H.S. and Batty R.S. 1990 Swimbladder 'behaviour' and target strength Rapp. P. -v. Reun Cons. perm. int. Explor. Mer. 189 233-44
- Blaxter J.H.S. and Batty R.S. 1984. The herring swimbladder; loss and gain of gas. J.Mar.Biol.Ass.U.K.,64 (2):441-459.
- Blaxter J.H.S. and Tytler P. 1978. Physiology and function of the swimbladder. Adv.Comp.Physiol.Biochem.7:311-367.
- Blindheim J. and Nakken O. 1971. Abundance estimation of the spawning Lofoten cod 1971. ICES C.M. 1971/B:15. (Mimeo)
- Bodholt H. 1977. Variance error in echo-integrator output. Rapp. P.-v. Reun.Cons.int.Explor.Mer 170: 196-204.
- Bodholt H. 1990. Fish density derived from echo integration and in situ target strength measurements. ICES C.M. 1990/B:11
- Boklach G.A. 1989. The effect of fish vessel acoustic fields on the behaviour of speedy fish concentrations. Proceedings of the institute of Acoustics, 11 (3), : 68-73.
- Box G.E.P. and Cox D.R. 1964. An analysis of transformations. J. Roy. Stat. Soc. B, 26, 211-252.
- Brawn V.M. 1969. Buoyancy of Atlantic and Pacific herring. J.Fish.Res. Board Can. 26: 2077-2091.

- Breder C.M. 1976. Fish schools as operational structures. *Fish. Bull.*, 74 (3), 1976 : 471-502
- Buerkle U. 1983. First look at herring distributions with a bottom referencing underwater towed instrumentation vehicle "BRUTIV". *FAO Fish. Rep.* 300, 1983: 125-130
- Buerkle U. 1987. Photographic and acoustic measurements in a large aggregation of herring. *Internat. Symp. Fish. Acoust.*, June 22-26, 1987, Seattle, Washington, USA : 28p.
- Buerkle U. and Sreedharan A. 1981. Acoustic target strengths of cod in relation to their aspects in the sound beam. Meeting on hydroacoustical methods for the estimation of marine fish populations, 25-29 June, 1979. Vol.2 Part a, J.B. Suomala ed. The Charles Stark Draper Laboratory, Inc. Cambridge, Mass. USA: 737-750.
- Burczynski J. 1982. Introduction to the use of sonar system for estimating fish biomass. *FAO Fish.Tech.Pap.*,(191) Rev.1: 1-89.
- Burczynski J. and Johnson R.L. 1986. Application of Dual-Beam acoustic survey techniques to limenitic populations of juvenile sockeye salmon (*Onchorhynchus nerka*). *Can. J. Fish. Aquat. Sci.* 43 (9) :1776-1788
- Casey J. and Warnes S. 1987. Selectivity of square mesh pelagic trawls for mackerel: preliminary results *ICES 1987/B:23*
- Claro R. and Garcia J.P. 1990. *Ecologia de los peces marinos de Cuba* (in press)
- Cochran, W.G. 1977. *Sampling techniques* (3rd ed.). John Wiley & Sons, New York, 428pp.
- Conan G.Y. (chairman) 1990. Report of the study group on the applicability of spatial statistical techniques to acoustic survey data. *ICES CM. 1990/D:34*, 103 pp.
- Conan G.Y. and Stolyarenko D. (chairmen), 1989. Report of the workshop on spatial statistical techniques. *ICES CM. 1989/K:38*, 42 pp.
- Conan G., Buerkle U., Wade E., Chadwick M., and Comeau M. 1988. Geostatistical analysis of spatial distribution in a school of herring. *CIEM C.M.:1988/D:21* :19 pp
- Cushing D.H. 1977. Observations on fish shoals with the ARL scanner. *Rapp. P.-V. Réun. CIEM*, 170 : 15-20.
- Dalen J. and Løvik A. 1981. The influence of wind induced bubbles on echo integration surveys. *J.Acoust.Soc.Am.*, 69(6):1653-1659.
- Dalen J. and Nakken O. 1983. On the application of the echo integration method. *Int Coun. Explor. Sea CM 1983/B:19*, 30pp (mimeo).
- Dalenius T. and Hodges Jr J.L. 1959. Minimum variance stratification. *Jour. Amer. Stat. Assoc.*, 54 : 88-101
- Dark T.A., Nelson M.O., Traynor J.J., and Nunnallee E.P. 1980. The distribution, abundance, and biological characteristics of Pacific hake, *Merluccius productus*, in the California-British Columbia region during July-September, 1977. *Mar. Fish. Rev.* 42 (3-4): 17-33.
- Davies I.E. 1973. Attenuation of sound by schooled anchovies. *J. Acoust. Soc. Am.*, 54(1) : 213-217.

- Degnol P., Lassen H. and Stæhr K.J. 1985. In situ determination of target strength of herring and sprat at 38 and 120 kHz. *Dana* 5: 45-54.
- Diner N. and Masse J. 1987. Fish school behaviour during echo survey observed by acoustic devices. *Internat. Symp. Fish. Acoustics*, June, 22-26, Seattle, : 28 pp
- Do M.A. and Surti A.M. 1982. Accumulative uncertainties in the quantitative evaluation of signals from fish. *Ultrasonics*, september 1982.
- Edwards J.I. and Armstrong F. 1983. Measurement of the target strength of live herring and mackerel. *FAO Fish.Rep.*,(300): 69-77.
- Edwards J.I., Armstrong F., Magurran A.E. and Pitcher T.J. 1984. Herring, mackerel and sprat target strength experiments with behavioural observations. *ICES CM 1984/B:34* (Mimeo).
- Efron B. and Tibshirani R. 1986. Bootstrap methods for standard errors, confidence intervals, and other measures of statistical accuracy. *Statistical Science* 2, 54-77.
- Ehrenberg J.E. 1974. Two applications for a dual-beam transducer in hydroacoustic fish assessment systems. *Proceedings of the IEEE International Conference on engineering in the ocean environment*, 21-23 August 1974, Halifax, Nova Scotia. New York, IEEE: 152-155. Issued also as *Univ.Wash.Sea Grant Publ.*, (WSG-TA-74-2).
- Ehrenberg J.E. 1983a. A review of in situ target strength estimation techniques. *FAO Fish.Rep.*,(300): 85-90.
- Ehrenberg J.E. 1983b. New methods for indirectly measuring the mean acoustic backscattering cross section of fish. *FAO Fish. Rep.* 300 : 91-98
- Ehrenberg J.E. and Lytle D.W. 1977. Some signal processing techniques for reducing the variance in acoustic stock abundance estimates. *Rapp. P.-v. Reun. Cons. Int. Explor. Mer*, 170 : 205-213
- Englund E. and Sparks A. 1988. *GEO-EAS (Geostatistical environmental assessment software) user's guide*. US Environmental Protection Agency, EPA/600/4-88/033a, Sept. 1988.
- Engås A. and Godø O.R. 1987a. Escapement of fish under the fishing line of Norwegian sampling trawl and its influence on survey results. *Internat. Symp. Fish. Acoust.*, June 22-26, 1987, Seattle, Washington, USA.
- Engås A. and Godø O.R. 1987b. Influence of trawl geometry and vertical distribution of fish on sampling with bottom trawl. *J.Northw.Atl.Fish.Sci.*, Vol 7: 35-42.
- Ermolchev V.A. and Zapherman M.L. 1981. Methods of absolute calibration of echo-integrating and echo-counting systems. In *Meeting on Hydroacoustical methods for the estimation of marine fish populations*, 25-29 June, 1979, Vol.2, Part a, edited by J.B. SUOMALA. Cambridge, Massachusetts, Charles Stark Draper Laboratory Inc., : 283-298.
- FAO 1972. *FAO catalogue of fishing gear designs*. Food and Agriculture Organisation, Rome, 155pp.
- Foot K.G. 1978. Analyses of empirical observations on the scattering of sound by encaged aggregations of fish. *Fisk.Dir.Skr.Ser. HavUnders.*,16:422-455.
- Foot K.G. 1979. On representing the length dependence of acoustic target strengths of fish. *J. Fish. Res. Board Can.*, 36 (12) : 1490-1496.

- Foote K.G. 1980. Importance of the swimbladder in acoustic scattering by fish: A comparison of gadoid and mackerel target strengths. *J. Acoust. Soc. Am.* 67(6) June 1980: 2084-2089.
- Foote K.G. 1981. Absorption term in time-varied-gain functions *Fisk Dir. Skr. Ser. HavUnders.* 17:191-213.
- Foote K.G. 1982a. Energy in acoustic echoes from fish aggregations. *Fisheries Research* 1: 129-140.
- Foote K.G. 1982b. Optimising copper spheres for precision calibration of hydroacoustic equipment. *J. Acoust. Soc. Am.* 71: 742-747.
- Foote K.G. 1983. Effect of fish behaviour on echo energy: the needs for measurements of orientation distribution. *J. Cons. int. Explor. Mer.* 39 (2) : 193-201
- Foote K.G. 1987a. Dependence of equivalent beam angle on sound speed. *ICES CM 1987/B:2* (Mimeo).
- Foote K.G. 1987b. Fish target strengths for use in echo integrator surveys. *J. Acoust. Soc. Am.* 82 (3), 981-987.
- Foote K.G. 1987c. Target strength of polarized fish. *ICES CM 1987/ B:4* (Mimeo).
- Foote K.G. 1988. Acoustic sampling volume versus equivalent beam angle. *ICES CM 1988/B:5*. (Mimeo).
- Foote K.G. 1990. Correcting acoustic measurements of scatterer density for extinction. *J. Acoust. Soc. Am.* 88(3):1543-1546.
- Foote K.G. and MacLennan D.N. 1984. Comparison of copper and tungsten carbide calibration spheres. *J. Acoust. Soc. Am.* 75: 612-616.
- Foote K.G. and Nakken O. 1978. Dorsal aspect target strength functions of six fishes at two ultrasonic frequencies. *Fisken Hav. Ser. B.*, 1978 (3):96 pp.
- Foote K.G. and Ona E. 1985. Swimbladder cross sections and acoustic target strengths of 13 Pollack and 2 saithe. *FiskDir. Skr. Ser. HavUnders.*, 18 :1-57.
- Foote K.G. and Stefansson G. 1990. Definition of the problem of estimating fish abundance over an area from acoustic line-transect measurements of density. *ICES Stat. Meet. C.M. 1990/D:25* : 17p.
- Foote K.G., Aglen A., and Nakken O. 1986. Measurements of fish target strength with a split-beam echo sounder. *J. Acoust. Soc. Am.* 80(2) :612-621
- Foote K.G., Knudsen H.P., Vestnes G., MacLennan D.N. and Simmonds E.J. 1987. Calibration of acoustic instruments for fish density estimation: a practical guide. *Int. Coun. Explor. Sea Coop. Res. Rep.* 144, 57pp.
- Fosse T.V., Hobaek H. and M. Vestrheim M. 1986. Acoustic imaging of fish. *ICES C.M. 1986/b:31*, 17p.
- Foster J.J., Campbell C.M. and Sabin G.C.W. 1981. The fish catching process relevant to trawls. IN *Bottom Trawl Surveys. Canadian special Publication of Fisheries and Aquatic Sciences*, 58, Ed Doubleday W.G. and D. Rivard, Ottawa, 1981, ISBN 0 660 50973 3, : 229-246
- Francis R.I.C.C. 1984. Variability in hydroacoustic biomass estimates (comment). *Can. J. Fish. Aquat. Sci.* 41: 825-826.

- Francis R.I.C.C. 1985. Two acoustic surveys of pelagic fish in Hawke Bay, New Zealand, 1980. *New Zealand Jour. Mar. Freshwater Res.*, 19 : 375-389.
- Francois R.E. and Garrison G.R. 1982. Sound absorption based on ocean measurements. Pt 1 Pure Water and Magnesium Sulphate contributions. *J.Acoust.Soc.Am.*72(3). September 1982. PT II Boric acid contributions and equation for total absorption. *J.Acoust.Soc.Am.*76(6), December 1982.
- Freon P. 1984. La variabilité des tailles individuelles à l'intérieur des cohortes et des bancs de poissons. I. Observations et interprétations. *Oceanolog. Acta*, 7, :457-468
- Freon P. and Gerlotto F. 1988a. Influence of fish behaviour on fish stocks abundance estimations. ICES/FAST Work. Groups, Ostend, Belgium, 19-22 april 1988: 7 pp
- Freon P. and Gerlotto F. 1988b. A methodology for in situ measurement of mean target strength in small schools. ICES, Working group on Fisheries Acoustic Science and Technology, Ostende, Belgique, mai 1988 ; 5p.
- Freon P. and Gerlotto F. 1988c. Methodological approach to study the biases induced by the fish behaviour during hydro-acoustic surveys. *Réun. Ann. Cons. Int. Explor. Mer*, CM 1988/B:52: 16 pp
- Freon P., Soria M. and Gerlotto F. 1989. Short-term variability of *Sardinella aurita* aggregations and consequences on acoustic survey results. ICES/FAST Work. Group Meet. Dublin, Ireland, 26-28 april 1989: 16 pp
- Frontier S. 1973. Etude statistique de la dispersion du zooplancton. *J. Exp. Mar. Biol. Ecol.*, 12 :229-262
- Frontier S. 1983. Stratégie d'échantillonnage en écologie. *Coll. Ecologie*, 17. Masson Ed., Paris : 494p.
- Furusawa M., Ishii K. and Miyanozana Y. 1982. Simultaneous calibration method for precise measurements of target strength of fish and attenuation of sound by schooled fish. *Symp.on Fish. Acoust.*, ICES/FAO, Bergen, Norway, 21-24 June 1982 (25): (Mimeo).
- Gerlotto F. 1987. Medición de las características acústicas de algunos peces tropicales. *Mem. Soc. Cienc. Nat. La Salle*, 47 (127-128), Enero-Dic. 1987: 149-167
- Gerlotto F. 1989. Choice of a strategy for sampling and stratifying the fish concentrations in tropical echo-integration. ICES, C.M. 1989/B:47, Ref. D : 15 pp.
- Gerlotto F. and Freon P. 1988a. School structure observed in some clupeid species. ICES/FAST Work. Groups, Ostend, Belgium, 19-22 april 1988: 10 pp
- Gerlotto F. and Freon P. 1988b. Influence of the structure and behaviour of fish schools on acoustic assessment. *Réun. Ann. Cons. Int. Explor. Mer*, CM 1988/B:53: 31 pp
- Gerlotto F. and Marchal E. 1987. The concept of Acoustic Populations : its use for analyzing the Results of Acoustic Cruises. *Internat. Symp. Fish. Acoust.*, June 22-26, 1987, Seattle, Washington, USA : 30pp.
- Gerlotto F. and Stequert B. 1983. Une methode de simulation pour etudier la distribution des densities en poissons: Application a deux cas reels. *FAO Fish.Rep.*(300), 278-292.

Gerlotto F., Bercy C. and Bordeau B. 1989. Echo Integration Survey around off-shore oil-extraction platforms off Cameroun : Observation of the repulsive effect on fish of some artificially emitted sounds. Proceedings of the institute of Acoustics, 11 (3), 1989 : 79-88.

Gerlotto F., Stequert B., Le Philippe V. and Freon P. 1976. Repartition et abondance des poissons pélagiques côtiers du plateau continental sénégalais évaluées par écho-intégration en avril-mai 1976 (campagne CAP 7605). Doc. Sci. Centre Rech. Océanogr. Dakar-Thiaroye, (62), oct. 1976 : 56p.

Gjøsæter J. and Tilseth S. 1983. Survey of mesopelagic fish resources in the Gulf of Oman, February 1983. Reports on Surveys with R/V "Dr. Fridtjof Nansen", Institute of Marine Research, Bergen.

Glass C.W. and Wardle C.S. 1989. Comparison of the reactions of fish to a trawl gear, at high and low light intensities. Fish. Res., 7 : 249-266.

Glass C.W., Wardle C.S. and Mojsiewicz W.R. 1986. A light intensity threshold for schooling in the atlantic mackerel, *Scomber scombrus*. J. Fish. Biol. , 1986, 29 (supplement A) : 71-81.

Gohin F. 1985. Geostatistics applied to fish distribution as derived from acoustic surveys. ICES/FAST Working Group Meet., Tromsø, 22-24 mai 1985: 6pp

Goncharov S.M., Borisenko E.S. and Pryanov A.I. 1989. Jack mackerel school defence reaction to a surveying vessel. Proceedings of the Institute of Acoustics, 11 (3), : 74-78.

Graves J.E. 1977. Photographic method for measuring space and density within pelagic fish schools at sea. Fish. Bull. NOAA/NMFS, 75 (1) : 230-234.

Guillard J., Gerdeaux D. and Chautru J.M. 1987. The use of geostatistics for abundance estimation by echointegration in lakes: the example of lake Annecy. Internat. Symp. Fish. Acoustics, June 22-26, 1987, Seattle, Washington, USA: 17 pp

Gulland J.A. 1983. Fish stock assessment, a manual of basic methods. FAO/Wiley series on food and agriculture, Vol. 1, 223pp.

Gyrin A., Rojewski M. and K. Somla K. 1981a. About the possibility of sea creature species identification on the basis of applying pattern recognition to echo signals. In Meeting on Hydroacoustical methods for the estimation of marine fish populations, 25-29 june, 1979, Vol.2, Part a, edited by J.B. SUOMALA. Cambridge, Massachusetts, Charles Stark Draper Laboratory Inc., : 455-456

Gyrin A., Somla K. and Rojewski M. 1981b. The number parameters of echo-sounder signals with respect to their usefulness to sea creatures species identification. In Meeting on Hydroacoustical methods for the estimation of marine fish populations, 25-29 june, 1979, Vol.2, Part a, edited by J.B. SUOMALA. Cambridge, Massachusetts, Charles Stark Draper Laboratory Inc., : 467-489.

Hagström O. and Røttingen I. 1982. Measurements of the density coefficient and average target strength of herring using purse seine. ICES CM 1982/B:33 (Mimeo).

Hagström O., Palmén L.E., Kastner D., Rechlin O. and Rothbarth H.B. 1985. Acoustic estimates of the herring and the sprat stocks in the Baltic proper 1983 and 1984. ICES CM 1985/J:4 (Mimeo).

Halldorsson O. 1983. On the behaviour of the Icelandic summer spawning herring (*Clupea harengus* L.) during echo surveying and depth dependence of acoustic target strength in situ. ICES CM 1983/H:36 (Mimeo).

- Halldorsson O. and Reynisson P. 1983. Target strength measurements of herring and capelin in situ at Iceland. *FAO Fish.Rep.* (300):78-84.
- Hamley J.M. 1975. Review of gillnet selectivity *J. Fish. Res. Board Can.* 32:1943-1969
- Hansen M.H., Hurwitz W.N. and Madow W.G. 1953. *Sample survey methods and theory*, vol. 1. Wiley and Sons, New York, N.Y. : 638p.
- Harden Jones F.R. 1968. *Fish Migration*. Edwards Arnold, London :325p.
- He P. and Wardle C.S. 1988. Endurance at intermediate swimming speed of Atlantic Mackerel, *Scomber scombrus* L., herring, *Clupea harengus* L., and saithe, *Pollachius virens* L. *J. Fish Biol.*, 33 (2), 1988 : 255-266
- Hogg R.V. and Craig A.T. 1968. *Introduction to mathematical statistics*. MacMillan Co., New Jersey, 384 pp.
- Hysten A., Nakken O. and Sunnanå K. 1985. The use of acoustic and bottom trawl surveys in the assessment of North-East Arctic cod and haddock stocks. A workshop on comparative biology, assessment and management of gadoids from North Pacific and Atlantic Oceans. Seattle, Washington, June 24-28, 1985. (Mimeo).
- Ibanez F. 1983. L'échantillonnage en continu en océanographie. In *FRONTIER, S.*, 1983. *Stratégie d'échantillonnage en écologie*. Coll. Ecologie, 17. Masson Ed., Paris : 365-384.
- ICNAF 1963. The selectivity of fishing gear. *Int. Comm. North Atlantic Fish., Spec. Publ.*, 5 : 1-225
- Jakobsson J. 1983. Echo surveying of the Icelandic summer spawning herring 1973-1982. *FAO Fish. Rep.* 300: 240-248.
- Jarvik A. and Suuronen P. 1990 Selectivity of Baltic herring trawls studied by the covered codend and twin codend methods. *ICES CM 1990/B:27* (mimeo).
- Johannesson K.A. and Losse G.F. 1977. Methodology of acoustic estimating of fish abundance in some UNDP/FAO resource survey projects. *Rapp. P.-v. Reun. Cons. int. Explor. Mer* 170, 296-318.
- Johannesson K.A. and Mitson R.B. 1983. *Fisheries acoustics: a practical manual for biomass estimation*. FAO Fish. Tech. Pap. 240 (249pp).
- Johannesson K.A. and Vilchez R. 1981. Applications and some results of echo integration methods in monitoring Peruvian anchovy resources. Meeting on hydroacoustical methods for the estimation of marine fish populations, 25-29 June, 1979, Vol.2, Part b, J.B. Suomala ed. Cambridge, Massachusetts, Charles Stark Draper Laboratory Inc.: 765-816.
- Jolly G.M. and Hampton I. 1987. Some common misconceptions in the statistical design and analysis of acoustic surveys to assess fish biomass. *Internat. Symp. Fish. Acoustics*, June, 22-26, Seattle, Washington, USA: 24 pp
- Jolly G.M. and Hampton I. 1990. A stratified random transect design for acoustic surveys of fish stocks. *Can. J. Fish. Aquat. Sci.* 47: 1282-1291.
- Journel A. and Huijbregts C. 1978. *Mining Geostatistics*, Academic Press, London
- Kendall M.G. and Buckland W.R. 1971. *A dictionary of statistical terms* (3rd ed.). Longman, London, 166pp.

- Kirkegaard E., Aglen A., Bailey R.S., Forbes S.T. and Hagström O. 1989. Report on the Herring acoustic surveys in the North Sea, Skagerrak and Kattegat during summer 1988. ICES C.M. 1989/H:37
- Kirkegaard K., Aglen A., Degnbol P., Hagström O., Palmén L-E., and Simmonds E.J. 1990. Report on the herring acoustic surveys in the North Sea, Skagerrak, and Kattegat during summer 1989. ICES CM. 1990/H:24, 39 pp.
- Kimura D.K. and Lemberg N.A. 1981. Variability of line intercept density estimates (a simulation study of the variance of hydroacoustic biomass estimates). *Can. J. Fish. Aquat. Sci.* 38: 1141-1152.
- Kish I. 1965. Survey sampling. Wiley and Sons, New York, N.Y. : 643p.
- Kizner Z.I., Tesler W.D., and Zaripov B.R. 1982. Construction and analysis of a statistical model of a fish concentration density field. Presented at the Symposium on Fisheries Acoustics, Bergen, Norway, 21-24 June, 1982, 19 pp.
- Knudsen H.P. 1985. T-A-F: time-amplitude-frequency: A special electronic unit for measuring the TVG function in research echo sounders. *FiskDir.Skr.Ser.HavUnders.*17: 529-541.
- Laloe F. 1985. Contribution à l'étude de la variance d'estimateurs de biomasse de poissons obtenus par écho-intégration. *Océanogr. Trop.*, 20 (2) :161-169
- Lamboeuf M., Burczynski J., Bencherifi S., Chbani M. and Elminowicz A. 1983. Evaluation acoustique de la biomasse des stocks de sardine au Maroc de 1979 à 1981. Combinaison des estimations du sonar et du sondeur vertical. *FAO Fish. Rep.* 300, 1983 : 197-207
- Lassen H. 1986. Signal threshold in echointegration ICES CM 1986/B:35 (Mimeo).
- Le Bourges A. 1990. Species Recognition based on the spectral signature of individual targets. ICES C.M. 1990/B:9, : 18 p.
- Levenez J.-J., Gerlotto F. and Petit D. 1987. Impact of lighting on the behavior of coastal tropical pelagic species. *Internat. Symp. Fish. Acoustics*, June, 22-26, Seattle, Washington, USA: 15 pp
- Lindem T. 1983. Successes with conventional in situ determinations of fish target strength. *FAO Fish.Rep.*,300: 104-111.
- Løvik A. 1977. Acoustic Holography: a future method for underwater viewing ? *Rapp. P.-V. réun. CIEM*, 170 : 319-327.
- Love R.H. 1971a. Measurement of fish target strength. A review. *Fish. Bull. NOASS/NMFS*, 69(4):703-715
- Love R.H. 1971b. Dorsal aspect target strength of an individual fish. *J.Acoust. Soc. Am.*, 49: 816
- Love R.H. 1977. Target strength of an individual fish at any aspect. *J.Acoust.Soc.Am.*62:1397-1403.
- Lytle D.W. and Maxwell D.R. 1978. Hydroacoustic estimation in high density fish schools. In *Proceedings of the Conference Acoustics in fisheries*. Held at the Faculty of Maritime and Engineering Studies, Hull College of Higher Education, Hull, England, 27-28 september, 1978. Bath, univ. of Bath, : 16p.

- Lytle D.W. and Maxwell D.R. 1982. Hydroacoustic assessment in high density fish schools. *FAO Fish.Rep.*(300): 157-171.
- McCartney B.S. and Stubbs A.R. 1971. Measurements of the acoustic target strengths of fish in dorsal aspect, including swimbladder resonance. *J.Sound.Vib.*,15. 397-420.
- McGraw-Hill dictionary of scientific and technical terms. 4th ed. McGraw Hill New York
- MacLennan D.N. and Forbes S.T. 1984. Fisheries acoustics: A review of general principles. *Rapp.P.-v. Reun.Cons.int.Explor.Mer* 184: 7-18.
- MacLennan D.N. and MacKenzie I.G. 1988. Precision of acoustic fish stock estimates. *Can. J. Fish. Aquat. Sci.* 45, 605-616.
- MacLennan D.N. and Simmonds E.J. 1991. *Fisheries Acoustics*. Chapman Hall, London, England, ISBN 0 412 33060-1 : 336p.
- MacLennan D.N., Hollingworth C.E. and Armstrong F. 1989. Target strength and the tilt angle distribution of caged fish. *Proceedings of the institute of Acoustics*, 11 (3), : 11-20.
- Main J. and Sangster G.I. 1981a. A study of the fish capture process in a bottom trawl by direct observations from a towed under water vehicle. *Scottish Fisheries Report* (23): 23p.
- Main J. and Sangster G.I. 1981b. A study of the sand clouds produced by trawl boards and their possible effect on fish capture. *Scottish Fisheries Research Report* (20): 20p.
- Marchal E. 1988. Recherches sur la signification du nombre d'échos, de la tension carrée moyenne et sur la possibilité d'utiliser cette valeur pour étalonner in situ un écho-intégrateur. *ICES, Fish Capture Committee*, 1988/B : 54 : 7p
- Marchal E. and Gerlotto F. 1985. The use of a digital echo-integrator to describe the echograms. *Comm. ICES/FAST Working group*, Tromso, 22/24 may 1985 : 3pp.
- Margalef R. 1967. Some concepts relative to the organization of plankton. *Oceanogr. mar. Biol. ann. Rev.*, 5 : 257-289.
- Masse J. 1988. Utilisation de l'écho-intégration en recherche halieutique (Analyse de 5 campagnes effectuées dans le Golfe de Gascogne de 1983 à 1987). *IFREMER DRV-88.030-RH/NANTES*, déc. 1988:156 pp
- Matheron G. 1965. *Les variables régionalisées et leur estimation*. Masson et Cie, Paris : 305 pp
- Matheron G. 1971. *The theory of regionalized variables and its application*. Les Cahiers du Centre de Morphologie Mathématique de Fontainebleau, Fasc. 5, Ecole Nat. Sup. des Mines de Paris
- Matheron G. 1989. *Estimating and choosing - an essay on probability in practice*. Springer verlag, Berlin.
- Mathisen O., Oestvedt O.J. and Vestnes G. 1974. Some variance components in acoustic estimation of nekton. *Extract de T-thys*, vol.6 nr.1-2, 1974 pp 303-312
- Medwin H. 1974. Acoustic fluctuations due to microbubbles in the near-surface ocean. *J.Acoust.Soc.Am.*56(5): 1100-1104.

- Midttun L. and Hoff I. 1962. Measurements of the reflection of sound by fish. *FiskDir.Skr.Ser.HavUnders.*,13(3): 1-18
- Midttun L. and Nakken O. 1977. Some results of abundance estimation studies with echo integrators. *Rapp P.-v.Reun. Cons.Explor. Mer* 170: 253-258. Feb 1977
- Miller D.S. 1985. The use of hydroacoustic surveys to estimate capelin biomass in NAFO Divisions 2J+3KLNO. NAFO SCR Doc. 85/105, serial No. N1081 : 18p.
- Misund O.A. 1987. Sonar observations of horizontal extension, swimming behaviour, and vessel and purse-seine avoidance of herring school. *Internat. Symp. Fish. Acoustics*, June, 22-26, Seattle, Washington, USA: 32 pp
- Misund O.A. and Aglen A. 1989. Swimming behaviour of schooling herring and sprat as recorded from a survey vessel. *ICES FAST W.G.*, April 24-26, 1989, Dublin, Ireland : 15p.
- Misund O.A. and Øvredal J.T. 1988. Acoustic measurements of schooling herring; estimation of school biomass and target strength. *Int. Coun. Explor. Sea CM* 1988/B:26, 16pp (mimeo).
- Misund O.A., Aglen A., Beltestad A.K. and Dalen J. 1990. Relationships between the geometric dimensions and biomass of schools. *ICES C.M.* 1990/B:41
- Mulligan T.J., Kieser R. and Gjernes T. 1987. A model for comparing fish density estimates from seine catches and from echo integration. *Can. J. Fish. Aquat. Sci.*, 44 (5), : 1024-1030
- Mulligan, T.J., Martin F.D., Smucker R.A. and Wright D.A. 1987. A method of stock identification based on the elemental composition of striped bass *Morone saxatilis* (Walbaum) otoliths. *J. Exp. Mar. Biol. Ecol.*, 114 (2-3) : 241-248
- Nakashima B.S. 1981. Sampling variation and survey design for capelin (*Mallotus villosus*) densities from an acoustic survey in Divisions 3LNO, 1980. NAFO SCR Doc. 81/II/14, Serial No N278 : 8p.
- Nakken O. and Dommasnes A. 1975. The application of an echo integration system in investigations of the stock strength of the Barents Sea capelin 1971-1974. *Int. Coun. Explor. Sea CM* 1975/B:25, 20pp (mimeo).
- Nakken O. and Olsen K. 1977. Target strength measurements of fish. *Rapp.P.-v. Réun.Cons.int.Explor.Mer*,170: 52-69.
- Nakken O. and Ulltang O.A. 1983. Comparison of the reliability of acoustic estimates of fish stock abundance and estimates obtained by other assessment methods in the northeast Atlantic. *FAO Fish. Rep.* 300, 249-261.
- Neproshin A.Y. 1978. Behavior of the pacific mackerel, *Pneumatophorus japonicus*, when affected by vessel noise. *J. Ichtyol.*, 18(4) : 695-699
- Neyman J. 1934. On the two different aspects of the representation method - the method of stratified sampling and the method of selection. *J. R. Statist. Soc.* 97: 558-606.
- Nickerson T.B. and Dowd R.G. 1977. Design and operation of survey patterns for demersal fishes using the computerized echo counting system. *Rapp. P.-V. Reun. Cons. Int. Explor. Mer.* 170: 232-236.
- Nion H. and Castaldo H. 1982. Analysis of a method for the study of schooling behaviour of anchovy, *Engraulis anchoita*. *Contrib.* 114, *Symp. Fish. Acoustics*, Bergen, June 21-24, 1982.

Nunnallee E.P. 1987. An alternative method of thresholding during echo integrator data collection. Internat. Symp. Fish. Acoustics, June 22-26, 1987, Seattle, Washington, USA.

Olsen K. 1971. Influence of vessel noise on behaviour of herring. In *Modern fishing gears of the world*, 3 Edited by H. KRISTJONSSON, London, Fishing News (books) Ltd. for FAO, : 291-294.

Olsen K. 1979 Observed avoidance behaviour in herring in relation to passage of an echo survey vessel. ICES C.M. 1979/B:18

Olsen K. 1986. Sound attenuation within school of herring. Coun. Meet. int. Coun. Explor. Sea, 1986, (B:44): 1-15

Olsen K. 1987. Fish behaviour and acoustic sampling. Internat. Symp. Fish. Acoustics, June 22-26, 1987 Seattle, Washington, USA

Olsen K. and Ahlquist I. 1989. Target strength of fish at various depth, observed experimentally. ICES C.M. 1989/B:53 : 8p.

Olsen K., Angell J. and Løvik A. 1983a. Quantitative estimations of the influence of fish behaviour on acoustically determined fish abundance. FAO Fish. Rep. 300: 139-149

Olsen K., Angell J., Pettersen E. and Løvik A. 1983b. Observed fish reactions to a surveying vessel with special reference to herring, cod, capelin and polar cod. FAO Fish. Rep. 300, 1983 : 131-138

Ona E. 1982. Mapping the swimbladder's form and form-stability for theoretical calculations of acoustic reflection from fish. Thesis. University of Bergen, Norway (In Norwegian).

Ona E. 1984. In situ observation of swimbladder compression in herring. ICES CM 1984/B:18 (Mimeo).

Ona E. 1987a. Physiological factors causing natural variations in target strength. Internat. Symp. Fish. Acoustics, June 22-26, 1987, Seattle, Washington, USA.

Ona E. 1987b. The equivalent ideal beam angle and its effective value when applying an integrator threshold. ICES CM 1987/B:35 (Mimeo).

Ona E. and Eger K. 1987. Sonar observations of trawl performance. Internat. Symp. Fish. Acoustics, 22-26 June 1987, Seattle, USA.

Ona E. and Godø O.R. 1987. Fish reaction to trawling noise: the significance to trawl sampling. Internat. Symp. Fish. Acoustics, June 22-26, 1987, Seattle, Washington, USA. (Mimeo).

Ona E. and Toresen R. 1988. Avoidance reactions of herring to a survey vessel, studied by scanning sonar. ICES C.M. 1989/H:46 :8p.

Ona E. and Vestnes G. 1985. Direct measurements of the equivalent beam angle of hull-mounted transducers. ICES CM 1985/H:43 (Mimeo).

Partridge B.L. and Pitcher T.J. 1979. Evidence against a hydrodynamic function of fish schools. *Nature*, London, 279 : 418-419

- Pauly D. and Tsukayama I. (Ed.) 1987. The Peruvian Anchoveta and its upwelling System: Three Decades of Change. ICLARM Contrib. 391, 1987 : 351 p
- Pennington M. 1983. Efficient estimators for fish and plankton surveys. *Biometrics* 39, 281-286.
- Petitgas P. 1990. Geostatistics for fish acoustic surveys: precision of the abundance estimate and survey efficiency. ICES, C.M. 1990/ : 27p.
- Petitgas P. and Poulard J.C. 1989. Applying stationary geostatistics to fisheries : a study on hake in the bay of Biscay. ICES, C.M. 1989/G :62, : 21p.
- Pitcher T.J. and Wyche C.J. 1983. Predator avoidance behaviours of sand-eel schools : why schools seldom split ? in D.L.G. Noakes, B.G. Lindquist, G.S. Helfman and J.A. Ward (Eds). *Predators and preys in fishes*, Junk, The Hague, : 193-204
- Radakov D.V. 1973. Schooling in the ecology of fish. Engl. transl., 1973, Wiley and Sons, New York : 173p.
- Reynisson P. 1985. A method for measuring the equivalent beam angle of hull mounted transducers. ICES CM 1985/B:4 (Mimeo).
- Richardson I.D. 1952. Some reactions of pelagic fish to light. *Fish. Invest. Minist. Agric. fish. Food G. B. (2 sea Fish.)*, 18 (1) : 20p.
- Robinson B.J. 1983. In situ measurements of the target strength of pelagic fishes. *FAO Fish.Rep.*,(300): 99-103.
- Robotham V.H. and Castillo J. 1987. The bootstrap method: an alternative to estimate confidence intervals of resources by means of hydroacoustic techniques. *Internat. Symp. Fish. Acoustics*, 22-26 June, 1987, Seattle, Washington, USA.
- Røttingen I. 1976. On the relation between echo intensity and fish density. *Fiskeridir. Skr. (Havunders.)*, 16 (9):301-314
- Sætersdal G., Strømme T., Bakken B. and Piekutowski L. 1983. Some observations on frequency dependent back scattering strength. *FAO Fish. Rep.* 300 : 156-156
- Serebrov L.I. 1974. Relationship between school density and size of fish. *J. Ichthyol.*, 16 : 135-140.
- Serebrov L.I. 1984. On density of distribution and orientation of capelin schools *Proc. Soviet-Norwegian Symp. on the Barents Sea Capelin*, 14-17 August, 1984, Bergen, Norway :157-170
- Shotton R. 1981. Acoustic survey design. In *Meeting on acoustical methods for the estimation of marine fish populations*, 25-29 June, 1979, 2, pp. 629-687. Ed. by J.B. Suomala. The Charles Stark Draper Laboratory, Inc., Cambridge, Mass., USA, 964 pp.
- Shotton R. and Bazigos G.P. 1984 Techniques and considerations in the design of acoustic surveys. *Rapp. P.-V. Reun. Cons. Int. Explor. Mer.* 184: 34-57
- Shotton R. and Dowd R.G. 1975. Current research in acoustic fish stock assessment at the Marine Ecology Laboratory. *ICNAF Res. Doc.*, 75/16, Ser. No. 3468, 17 pp.

- Simard Y. and Gerlotto F. 1990. Exploration of the applicability of geostatistics in fisheries acoustics. CIEM/ICES Working group on Fish. Acoust. Sci. Technol., Rostock, April 1990 : 27p.
- Simard Y. and Savard L. 1990. Variability, spatial patterns and scales of similarity in size-frequency distributions of the northern shrimp (*Pandalus borealis*) and its migrations in the Gulf of St. Lawrence. *Can. J. Fish. Aquat. Sci.*, 47 : 794-804
- Simard Y., Legendre P., Lavoie G. and Marcotte D. (in p.). Mapping, estimating biomass and optimizing sampling programs for spatially autocorrelated data: case study of the northern shrimp.
- Simmonds E.J. 1984a. A comparison between measured and theoretical equivalent beam angles for seven similar transducers. *J.Sound Vib.*,97: 117-128.
- Simmonds E.J. 1984b. The effect of mounting on the equivalent beam angle of acoustic survey transducers. ICES CM 1984/B:32 (Mimeo).
- Simmonds E.J. 1989. Survey and Data Analysis Procedures. ICES FAST Working Group, Dublin, april 1989: 11 pp
- Simmonds E.J. and Armstrong F. 1987. A wide band echosounder: measurement on cod, saithe, herring and mackerel from 27 to 54 kHz. *Internat. Symp. Fish. Acoustics*, June 22-26, 1987, Seattle, Washington, USA
- Simmonds E.J. and Forbes S.T. 1980. Some range dependent variations affecting acoustic fish stocks estimations ICES CM 1980/B:17 (Mimeo).
- Simmonds E.J. and MacLennan D.N. 1988. Survey and data analysis procedures. *Int. Coun. Explor. Sea CM 1988/B:58*, 15pp (mimeo).
- Simmonds E.J., Bailey R.S. and Aglen A. 1987. Report on the 1986 herring acoustic survey in the northern North Sea. ICES CM 1987/H:11 (Mimeo).
- Simmonds E.J., Petrie I.B. and Armstrong F. 1984. An automated system for echo sounder calibration using a computer controlled three wire suspension for standard targets ICES CM 1984/B:33 (Mimeo).
- Simmonds E.J., Bailey R.S., McKay D.W., Aglen A. and Iversen S.A. 1986. Report on the 1985 ICES-coordinated herring acoustic survey in the northern North Sea. ICES CM 1986/H:16 (Mimeo).
- Smith S.J. 1990. Use of statistical models for the estimation of abundance from groundfish trawl survey data. *Can. J. Fish. Aquat. Sci.* 47: 894-903.
- Sokal R.R., and Rohlf F.J. 1969. *Biometry*. W H Freeman and Co San Francisco.
- Souid P. 1989. Automatisation de la description et de la classification des détections acoustiques de bancs de poissons pélagiques pour leur identification. Thèse Doct. Univ. Aix-Marseille II, déc. 1988 : 223p.
- Stæhr K. and Neudecker T. 1990. Report on the acoustic survey in ICES sub.div. 22, 23, and 24 in November 1989. ICES CM. 1990/J:13, 21 pp.
- Stanton T.K. 1982. Effects of transducer motion on echo-integration techniques. *J.Acoust.Soc.Am.*72(3):947-949.

- Stewart P.A.M. and Galbraith R.D. 1987 Investigating the capture efficiency of survey gears ICES CM1987/B:7 (mimeo)
- Strange E.S. 1981. An introduction to commercial fishing gear and methods used in Scotland. Scottish Fisheries Information Pamphlet, No. 1, 35pp.
- Strømme T. and Sætersdal G. 1987. Consistency of acoustic biomass assessments tested by repeated survey coverages. Internat. Symp. Fish. Acoustics, June 22-26, 1987, Seattle, Washington, USA.
- Suomala J.B. and Yudanov K.I. (eds). 1980. meeting on hydroacoustical methods for the estimation of marine fish populations, 25-29 June 1980. The Charles Stark Draper Laboratory, Inc., Cambridge, Mass., USA.
- Suuronen P. 1990. Preliminary trials with a square mesh codend in pelagic herring trawls. ICES 1990/B:28 (mimeo)
- Thorne R.E. 1983. Application of hydroacoustic assessment techniques to three lakes with contrasting fish distributions. FAO Fish. Rep. 300, 269-277.
- Thorne R.E., Hedgepeth J. and Campos J. 1989. Hydroacoustic observations of fish abundance around an artificial reef in Costa Rica. Bull. Mar. Sci., 44 (2) : 1058-1064.
- Toresen R. 1990. Absorption of acoustic energy in dense herring schools studied by attenuation in the bottom echo signal. ICES C.M. 1990/B:2 (Mimeo).
- Traynor J.J. and Nelson M.O. 1985. Methods of the U.S. hydroacoustic survey. IN R.G. Bakkala and K. Wakabayashi (Eds), Results of cooperative US-Japan groundfish investigations in the Bering Sea during May-August, 1979. INPFC Bull. 44 : 30-34
- Traynor, J.J. and Williamson N.J. 1983. Target strength measurements of walleye pollock (*Theragra chalcogramma*) and a simulation study of the dual beam method. FAO Fish.Rep.(300): 112-124.
- Traynor J.J., Williamson N.J. and Karp W.A. 1987. A consideration of the accuracy and precision of fish abundance estimates derived from echo integration surveys. Internat. Symp. Fish. Acoustics, June, 22-26, Seattle, Washington, USA.
- Traynor J.J., Karp W.A., Furusawa M., Sasaki T., Teshima K., Sample T.M., Williamson N.J., and Yoshimura T. 1990. Methodology and biological results from surveys of walleye pollock (*Theragra chalcogramma*) in the eastern Bering Sea and Aleutian Basin in 1988. Int. North Pac. Fish. Comm. Bull. 50: 69-99.
- Truskanov M.D. and Sherbino M.N. 1962. Taking Atlanto-scandinavian herring as an example for determining the size of dense aggregation of fish. Trudy PNIRO, 14., 1962
- Truskanov M.D. and Zapherman M.L. 1977. Some characteristics of hydroacoustic methods of determination of fish abundance in sound scattering layers. Rapp. P.-V. Réun. CIEM, 170 : 245-247.
- Urick R.J. 1975. Principles of underwater sound. 2.ed., Mc.Graw-Hill Book Company, New York 1975. 384 pp
- Van Olst J.C. and Hunter J.R. 1970. Some aspects of the organization of fish schools. J. Fish. Res. Board Can., 27 (7) : 1225-1238.

- Venema S.C. (Eds), 1983. Symposium on Fisheries Acoustics. Selected papers of the ICES/FAO Symposium on Fisheries Acoustics. Bergen, Norway, 21-24 June 1982. FAO Fish. Rep., (300): 278-292
- Vilhjalmsson H. 1983. Biology, abundance estimates and management of Icelandic stock of capelin. Rit Fiskideildar Vol 7 No 3
- Vilhjalmsson H. 1987. Acoustic abundance estimates of the capelin in the Iceland-Greenland-Jan Mayen area in 1978-1987. Internat. Symp. Fish. Acoustics, June, 22-26, Seattle, Washington, USA.
- Vilhjalmsson H., Reynisson P., Hamre J. and Røttingen I. 1983. Acoustic abundance estimation of the Icelandic stock of capelin, 1978-1982. in NAKKEN, O., and S.C. VENEMA (ed.), Symposium on Fisheries Acoustics. Selected papers of the ICES/FAO symposium on Fisheries Acoustics. Bergen, Norway, 21-24 June 1982. FAO Fish. Rep., (300) : 208-217
- Von Brandt A. 1984. Fish catching methods of the world, 3rd ed. Fishing News Books, London, 418pp.
- Vorobyov V.M. 1983. On planning an echo survey. FAO Fish. Rep. 300: 299-309.
- Vray D., Gimenez G. and Person R. 1987. Attempt of classification of echo-sounder signals based on the linear discriminant function of Fisher. Contrib. Int. Symp. Fish. Acoustics, June 22-26, 1987, Seattle, Washington, USA.
- Walsh M. and Armstrong F. 1985. Investigations on mackerel shoals and echotrace characteristics north west of Scotland in October 1984. ICES C.M. 1985/H:62.
- Wardle C.S. 1983. Fish reactions to towed gears. pp 167-195 In: "Marine biology at sea", A. MacDonald and A.G. Priede eds, Academic Press, London, 414pp.
- Wardle C.S. 1986. Fish behaviour and Fishing gear. IN Pitcher, T.J. (Ed), The Behaviour of teleost fish. Croom Helm, London, ISBN 0 7099 2070 9, : 463-495
- Wardle C.S. and He P. 1988. Burst swimming speed of mackerel, *Scomber scombrus* L. J. Fish Biol., 32 (3), 1988 : 471-478
- Weih D. 1973. Hydromechanisms in fish schooling. Nature (Lond.), 1973, 241 : 443-448
- Williamson N.J. 1982. Cluster sampling estimation of the variance of abundance estimates derived from quantitative echo sounder surveys. Can. J. Fish. Aquat. Sci., 39 : 229-231
- Yudanov K.T. and Kalikhman I.L. 1981. Sound scattering by marine animals. Meeting on Hydroacoustical Methods for the Estimation of Marine Fish Populations, Cambridge, Massachusetts, 25-29 June 1979. In Proc., Vol.2, pp. 53-95.
- Yudovich 1954. Scouting and fishing of prespawning sakkhalin herring with the use of hydroacoustic equipment. Rybnoe Khozyaistvo, 12, 1954.
- Zapherman M.L. and Serebrov L.I. 1988. Underwater techniques for quantitative assessment of commercial bottom organisms. ICES C.M. 1988/B:8, Fish Capture Committee.
- Zakharia M.E. and Sessarego J.P. 1982. Target recognition using a coherent echo-processing. IEEE, IC-ASSP, Paris, 1982.

Zakharia M.E. 1987. A prototype of wide-band sonar for fisheries in lakes and rivers. Internat. Symp. Fish. Acoustics, June 22-26, 1987, Seattle, Washington, USA.

APPENDIX I

Power Transformations

This section is taken from MacLennan and MacKenzie (1988) and MacLennan and Simmonds (1991). Consider the data set F_i consisting of N independent observations of the fish density ($i = 1, 2 \dots N$). The F_i are all greater than zero and N is 2 or more. We suppose that the F_i are random samples with some probability distribution which is unlikely to be normal. It is convenient to work with normally distributed data, and this might be achieved by a transformation. In the case of the power transform, a new data set Y_i is obtained from the equations:-

$$Y_i = F_i^\lambda \text{ for } \lambda > 0 \quad (98)$$

$$= \ln(F_i) \text{ for } \lambda = 0$$

We suppose that for some value of the parameter λ , the Y_i are normally distributed. The sample mean m and the residual sum of squares S are:-

$$m = \sum_i Y_i / N \quad (99)$$

$$S = \sum_i (Y_i - m)^2$$

\hat{F} is an estimate of the true mean density, and \hat{V} is the variance of \hat{F} . The estimation formulae described below are applicable to a few discrete values of λ (MacLennan and MacKenzie, 1988).

Square-root normal ($\lambda = 1/2$)

$$\hat{F} = m^2 + S/N \quad (100)$$

$$\hat{V} = \frac{4Sm^2}{N(N-1)} + \frac{S^2}{N^2} - \frac{S^2}{N^2-1} \left(1 - \frac{2}{N} + \frac{3}{N^2} \right) \quad (101)$$

Cube-root normal ($\lambda = 1/3$)

$$\hat{F} = m^3 + 3mS/N \quad (102)$$

$$\hat{V} = \frac{9m^4S}{N(N-1)} + \frac{9m^2S^2}{(N-1)^2} \left[\left(1 - \frac{1}{N} \right)^2 - \frac{N-1}{N+1} \left(1 - \frac{4}{N} + \frac{S}{N^2} \right) \right] + \frac{3S^3}{N(N^2-1)(N+3)} \left(3 - \frac{6}{N} + \frac{S}{N^2} \right) \quad (103)$$

Fourth-root normal ($\lambda = 1/4$)

$$\hat{F} = m^4 + 6m^2S/N + 3(N-1)(S/N)^2/(N+1) \quad (104)$$

$$\begin{aligned} \hat{V} = & \hat{F}^2 - m^2 - \frac{m^6S}{N-1} \left(12 - \frac{28}{N} \right) - \frac{m^4S^2}{N^2-1} \left(\frac{210}{N^2} - \frac{180}{N} + 42 \right) \\ & - \frac{m^2S^3}{(N^2-1)(N+3)} \left(36 - \frac{252}{N} + \frac{540}{N^2} - \frac{420}{N^3} \right) \\ & - \frac{S^4}{(N^2-1)(N+3)(N+5)} \left(9 - \frac{36}{N} + \frac{126}{N^2} - \frac{180}{N^3} + \frac{105}{N^4} \right) \end{aligned} \quad (105)$$

Sixth-root normal ($\lambda = 1/6$)

$$\hat{F} = m^6 + \frac{15m^4S}{N} + \frac{45S^2m^2(N-1)}{(N+1)N^2} + \frac{15S^3(N-1)^2}{(N+1)(N+3)N^3} \quad (106)$$

$$\begin{aligned} \hat{V} = & \hat{F}^2 - m^{12} - \frac{6m^{10}S}{N-1} \left(5 - \frac{11}{N} \right) - \frac{45m^8S^2}{(N^2-1)} \left(7 - \frac{30}{N} + \frac{33}{N^2} \right) \\ & - \frac{60m^6S^3}{(N^2-1)(N+3)(N+5)} \left(11 - \frac{92}{N} + \frac{294}{N^2} - \frac{420}{N^3} + \frac{231}{N^4} \right) \\ & - \frac{270m^2S^5}{(N^2-1)(N+3)(N+5)(N+7)} \left(5 - \frac{55}{N} + \frac{230}{N^2} - \frac{490}{N^3} + \frac{525}{N^4} - \frac{231}{N^5} \right) \\ & - \frac{45S^6}{(N^2-1)(N+3)(N+5)(N+7)(N+9)} \left(5 - \frac{30}{N} + \frac{165}{N^2} - \frac{460}{N^3} + \frac{735}{N^4} - \frac{450}{N^5} + \frac{231}{N^6} \right) \end{aligned} \quad (107)$$

Log normal ($\lambda = 0$)

$$\hat{F} = e^m G_n(0.5S/(N-1)) \quad (108)$$

$$\hat{V} = \hat{F}^2 - e^{2m} G_n(S(N-2)/(N-1)^2) \quad (109)$$

The function G_n is computed from the following algorithm:-

$$G_n(u) = 1 + (N-1)u/N \quad (110)$$

$$x = (N-1)^3 u^2 / (2N^2(n+1)); \quad j = 3 \quad (111)$$

$$G_n(u) \rightarrow G_n(u) + x \quad (112)$$

$$x \rightarrow x(N-1)^2 u / (Nj(N+2j-3)); \quad j \rightarrow j+1 \quad (113)$$

The last two lines are repeated until x is very close to zero.

The Box-Cox test

The estimation formulae are unbiased only if the transformed variable has a normal distribution. The formulae then represent minimum variance unbiased estimators (MVUEs). It is therefore necessary to determine the value of λ most appropriate to a given data set. This can be done using a test devised by Box and Cox (1964). Equation 98 is not continuous at $\lambda = 0$, and to overcome this difficulty the test is applied to another data set Z_i , defined as:-

$$\begin{aligned} Z_i &= (F_i^\lambda - 1) / \lambda \quad \text{for } \lambda > 0 \\ &= \ln(F_i) \quad \text{for } \lambda = 0 \end{aligned} \quad (114)$$

The Box-Cox function is:-

$$L(\lambda) = -(N/2) \ln \left(\sum_{i=1}^N (Z_i - \bar{Z})^2 \right) \quad (115)$$

The maximum of λ , at λ_m say, indicates the value of λ for which the transformed data are most nearly matched to the normal distribution. A 95% confidence interval on λ_m , λ_1 to λ_2 say, is obtained as the solution of:-

$$L(\lambda_1) = L(\lambda_2) = L(\lambda_m) - 1.92 \quad (116)$$

Zero Values

If the species of interest is absent from part of the surveyed area, some of the observed densities will be zero (empty water) while the others are stochastic samples taken within the regions where fish are found. The density is non-stationary but the mean and variance can be estimated by the method of Aitchison (1955) which treats the zero and non-zero data separately. Consider the probability distribution.

$$\begin{aligned} P_1(F) &= p \quad \text{for } F = 0 \\ &= (1-p)P(F) \quad \text{for } F > 0 \end{aligned} \quad (117)$$

p is the finite probability that an observation will be exactly $F = 0$. Assume that $P(F)$ is such that under the transformation $F(\lambda) \rightarrow Z$, the Z are approximately normally distributed. Let:-

$$\begin{aligned}\hat{F} &= E(F \mid F > 0) \\ \hat{V} &= \text{Var}(\hat{F} \mid F > 0)\end{aligned}\tag{118}$$

Thus \hat{F} and \hat{V} are determined by the non-zero values only. For a sample of size M containing N values greater than zero, Pennington (1983) gives the following formulas for \hat{F} , the estimate of the mean, and \hat{V} , the estimated variance of the mean:-

$$\hat{F}_r = N\hat{F}/M\tag{119}$$

$$\hat{V}_r = N(M-N)\hat{F}^2/(M^2(M-1)) + N(N-1)\hat{V}/(M(M-1))\tag{120}$$

The estimate of p is N/M . The most appropriate estimators (according to the Box-Cox test) are first used to obtain \hat{F} and \hat{V} from calculations with the non-zero data. Then above equations provide the equivalent statistics for the whole sample, taking account of the regions with and without fish.

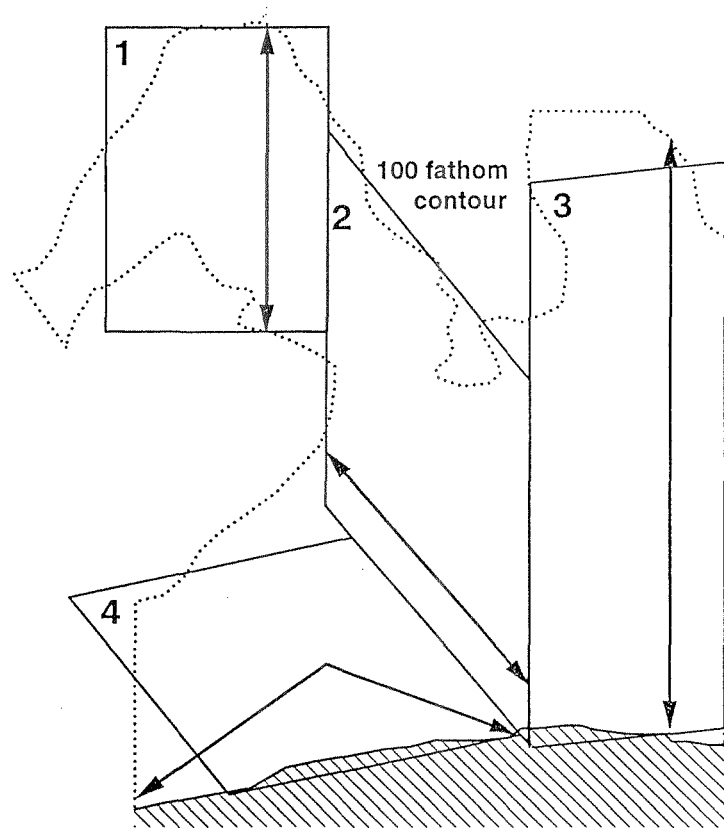

Figure 1 Method of parallelograms - randomized transects based on proportional allocation to area for each parallelogram (redrawn from Shotton and Dowd, 1975).

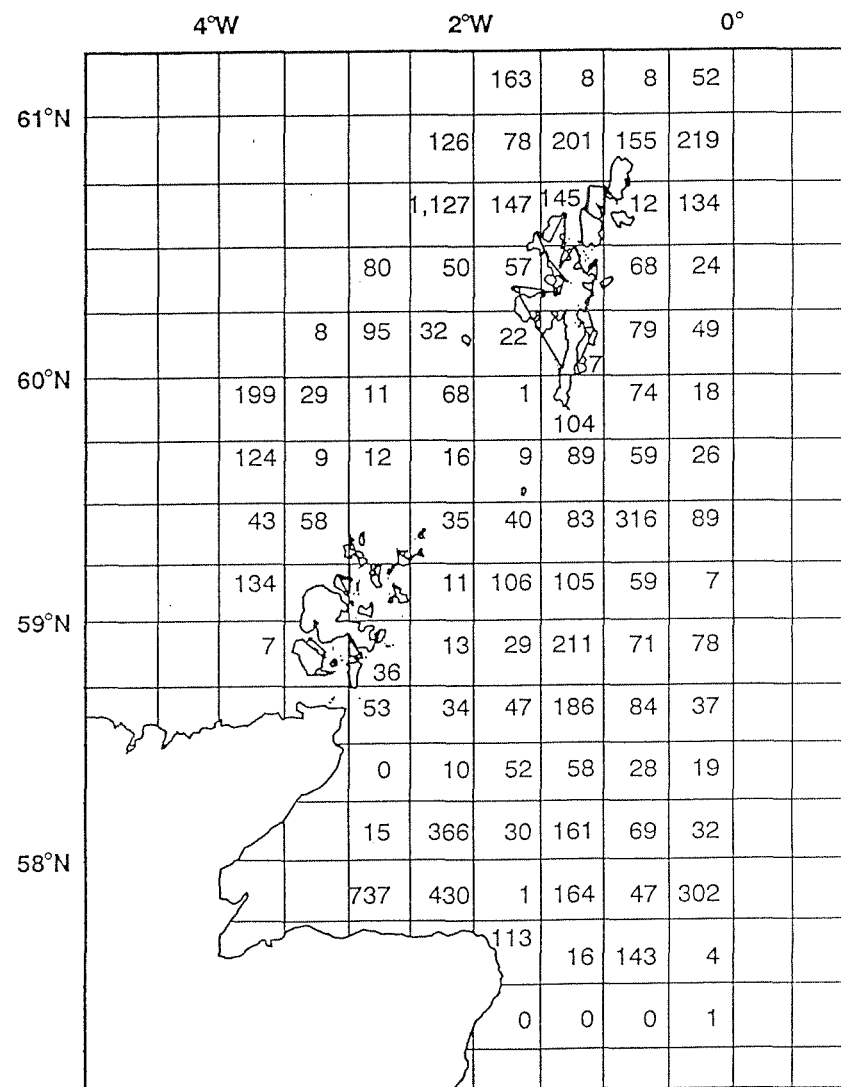

Figure 2 ICES statistical rectangles (redrawn from Kirkegaard *et al.*, 1990).

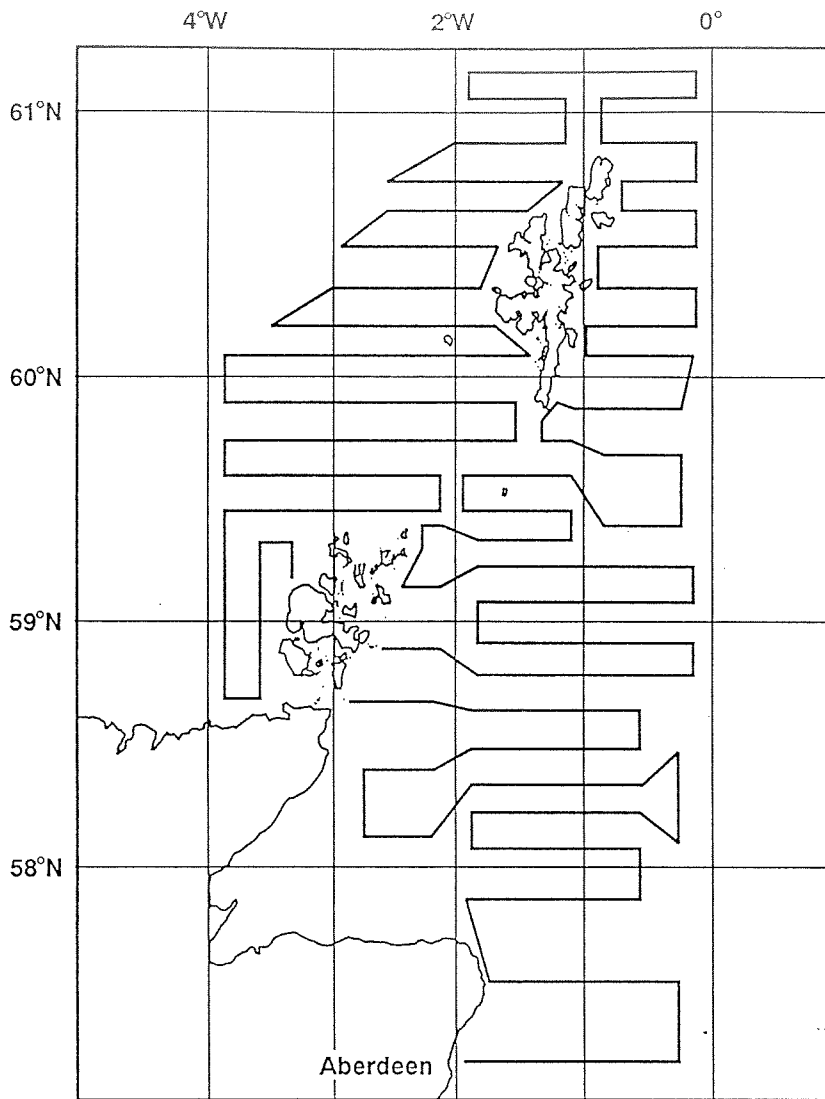

Figure 3 Survey track for summer 1989 acoustic survey of North Sea herring (redrawn from Kirkegaard *et al.*, 1990).

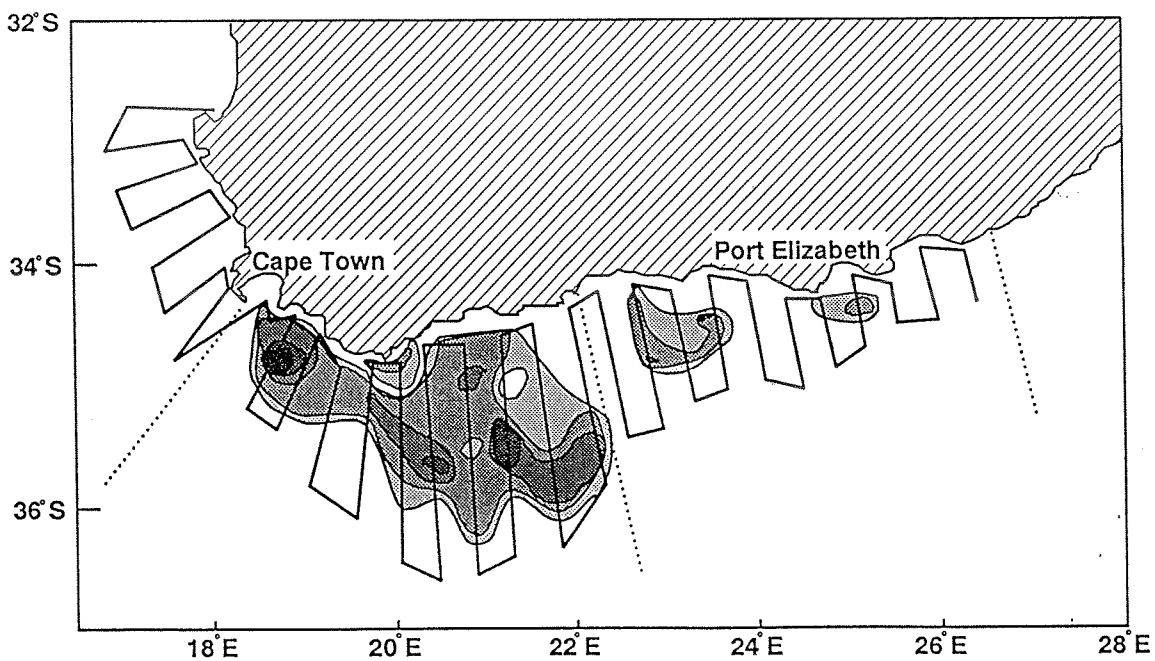

Figure 4 Anchovy distribution and cruise track from 1984 acoustic survey off the coast of South Africa (redrawn from Jolly and Hampton, 1990).

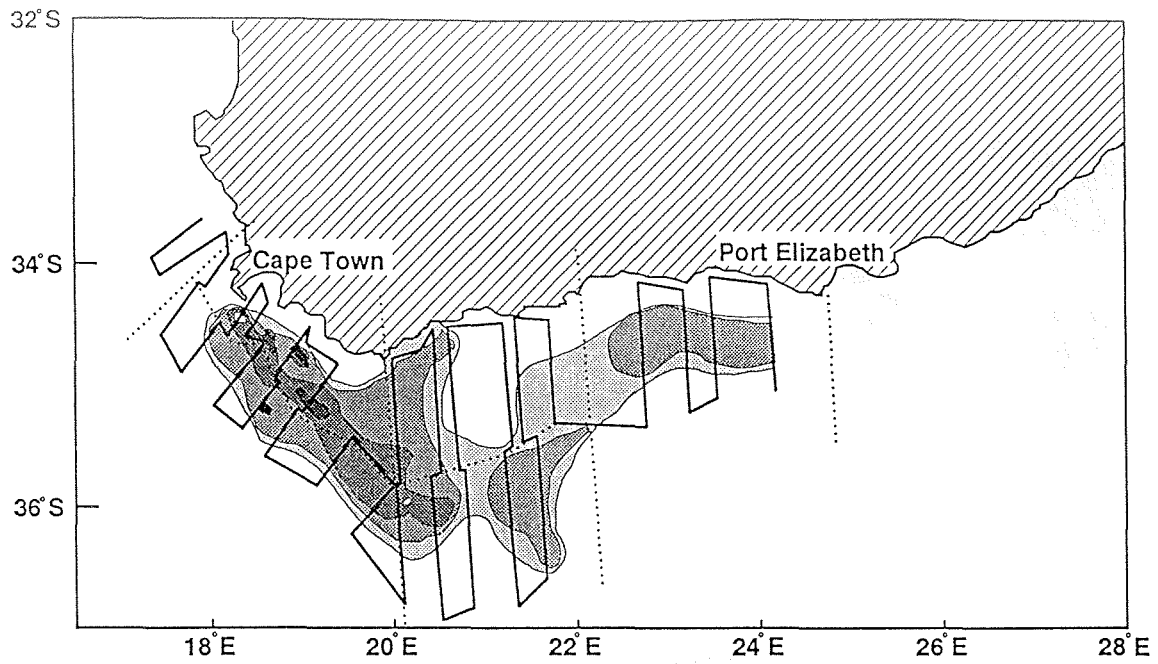

Figure 5 Anchovy distribution in November 1985 from Phase 1 acoustic survey. Only Phase 1 transects shown (redrawn from Jolly and Hampton, 1990).

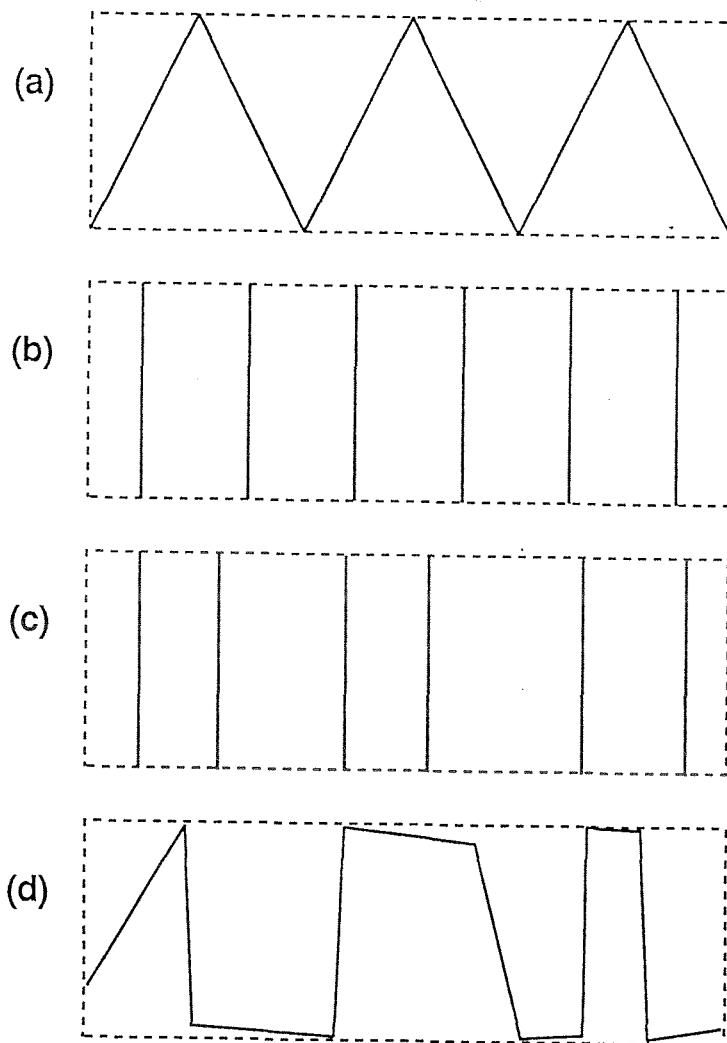

Figure 6 Track designs - a) systematic zigzag, b) systematic parallel, c) random parallel, and d) haphazard.

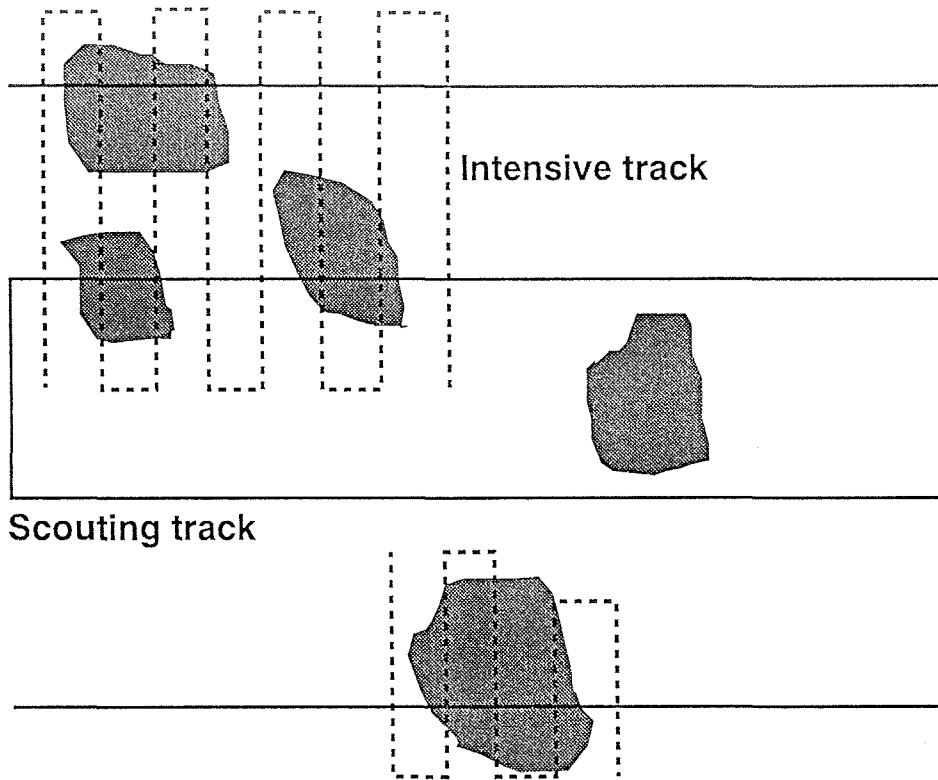

Figure 7 The outline survey. Fish concentrations (dark patches) detected by the initial scouting grid (solid line) are later surveyed more intensively (dotted lines), but some concentrations may not be detected at all (redrawn from MacLennan and Simmonds, 1991).

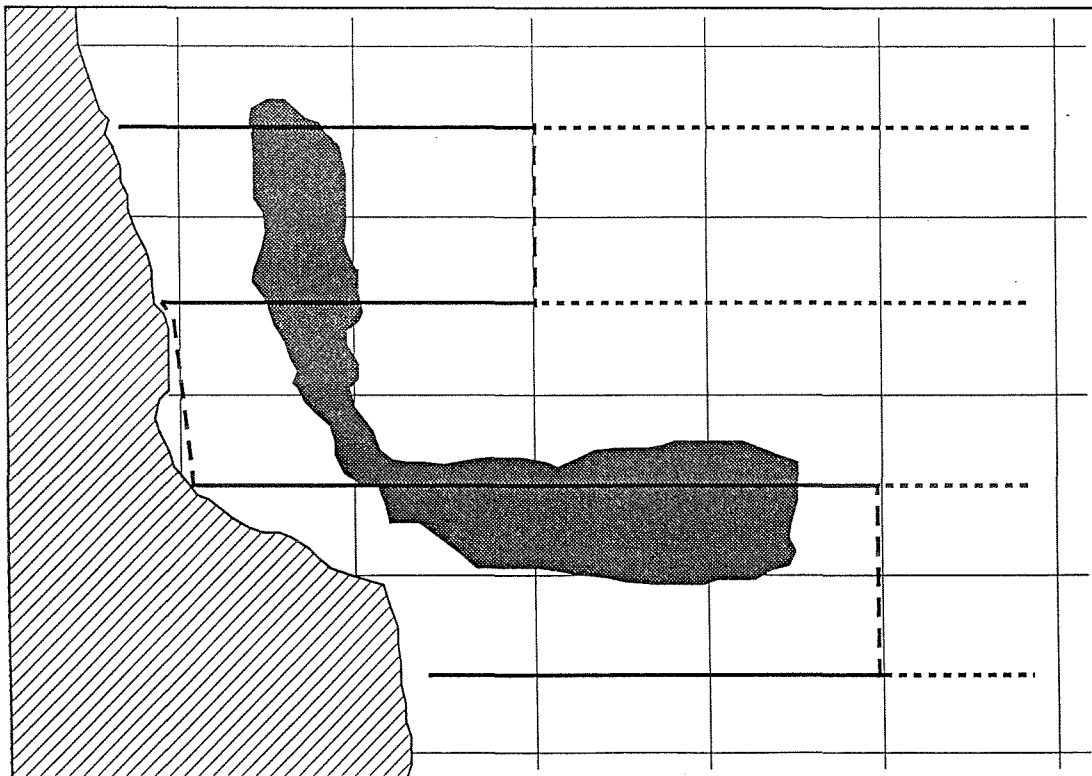

Figure 8 Adaptive survey, variable transect length. The squares (light line) are the analysis area elements. The grey scale is the fish density. The dark line is the cruise track. On each offshore run, the transect ends when the fish density is consistently low and the edge of a square is reached (redrawn from MacLennan and Simmonds, 1991).

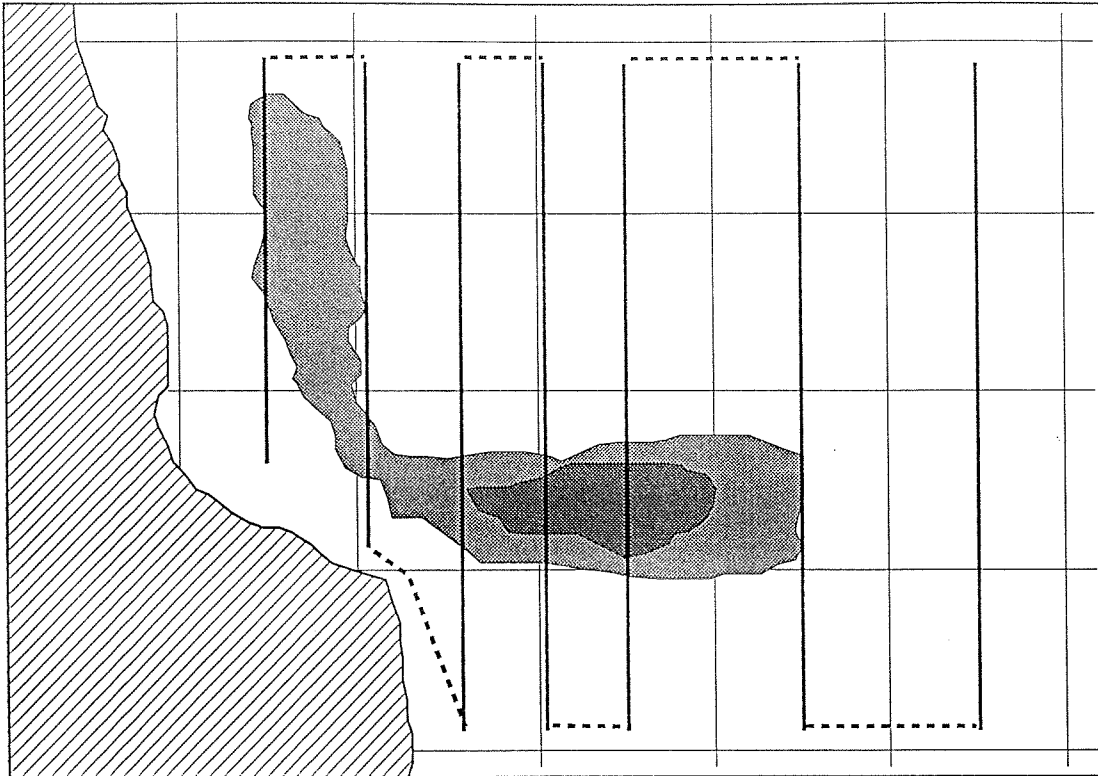

Figure 9 Adaptive survey, variable transect spacing. The squares (light lines) are the analysis area elements. The grey scale is the fish density. The dark line is the cruise track. When high densities are observed, the transect spacing is reduced and *vice versa* (redrawn from MacLennan and Simmonds, 1991).

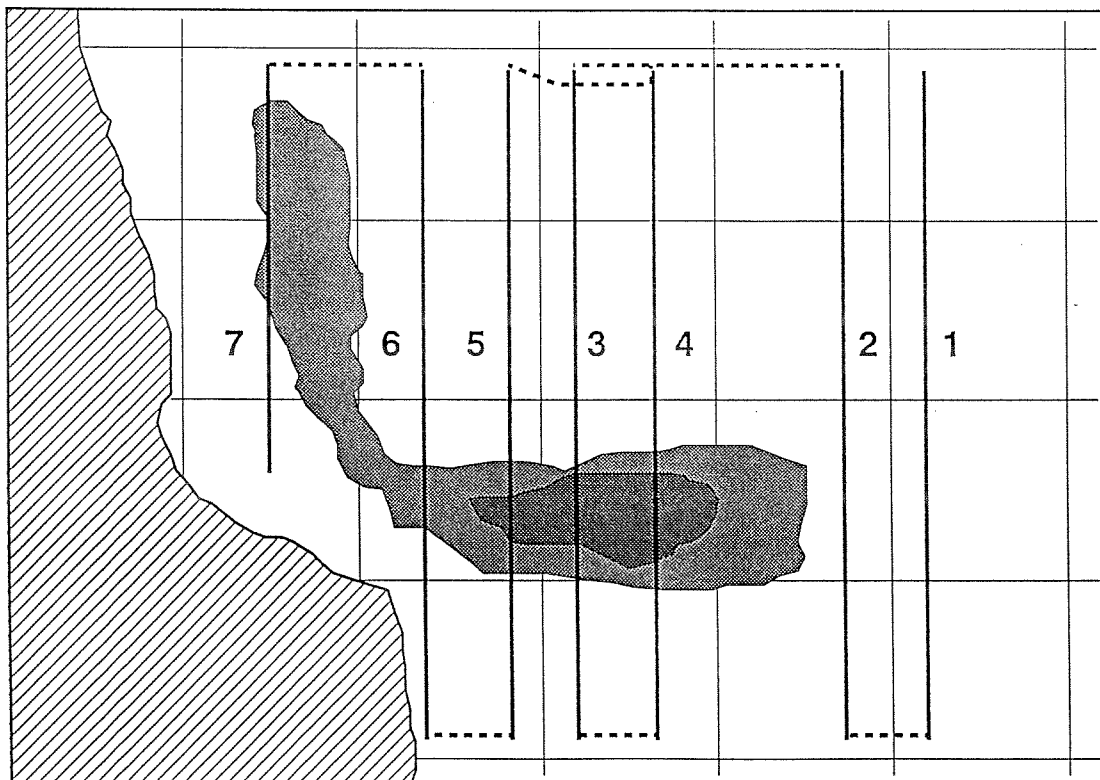

Figure 10 Randomised adaptive survey. The grey scale is the fish density. The light lines are the zone boundaries. The dark line is the cruise track. When high densities are observed, an extra transect is randomly positioned in each zone. The transects are numbered in the order run (redrawn from MacLennan and Simmonds, 1991).

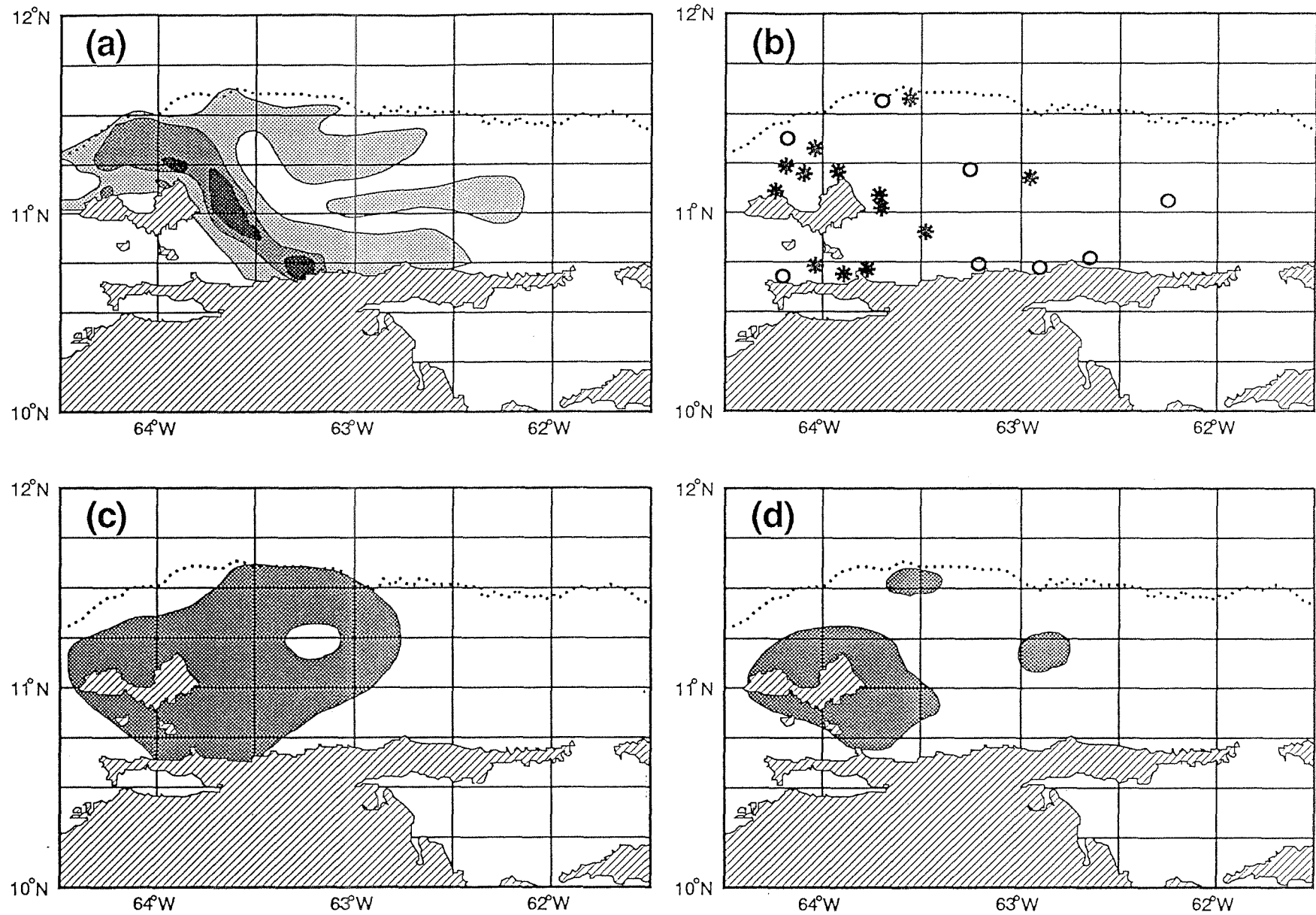

Figure 11

From ECHOVEN 2, 1986 Venezuela: a) global densities; b) positions of trawl hauls * with o without sardine; c) "optimistic extent of sardine"; and d) "pessimistic" extent of sardine.

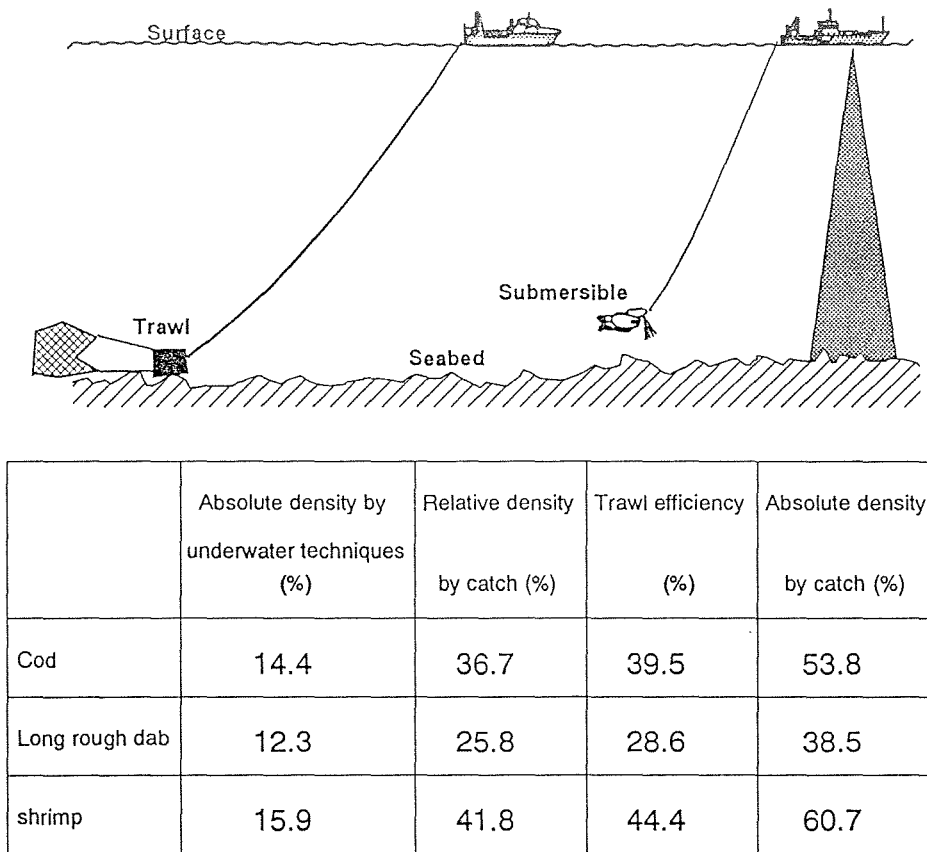

Figure 12 Calibration of a bottom trawl with the help of a submersible (redrawn from Zaferman and Serebrov, 1988).

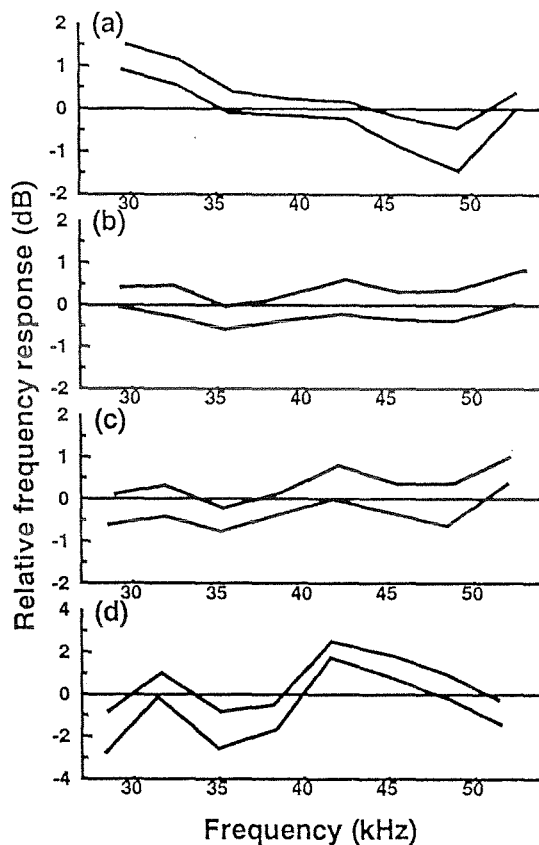

Figure 13 Average spectra ± 1 standard deviation for four species: a) herring; b) saithe; c) cod; and d) haddock (using a 27-54 wide-band echo sounder), from Simmonds and Armstrong (1987).

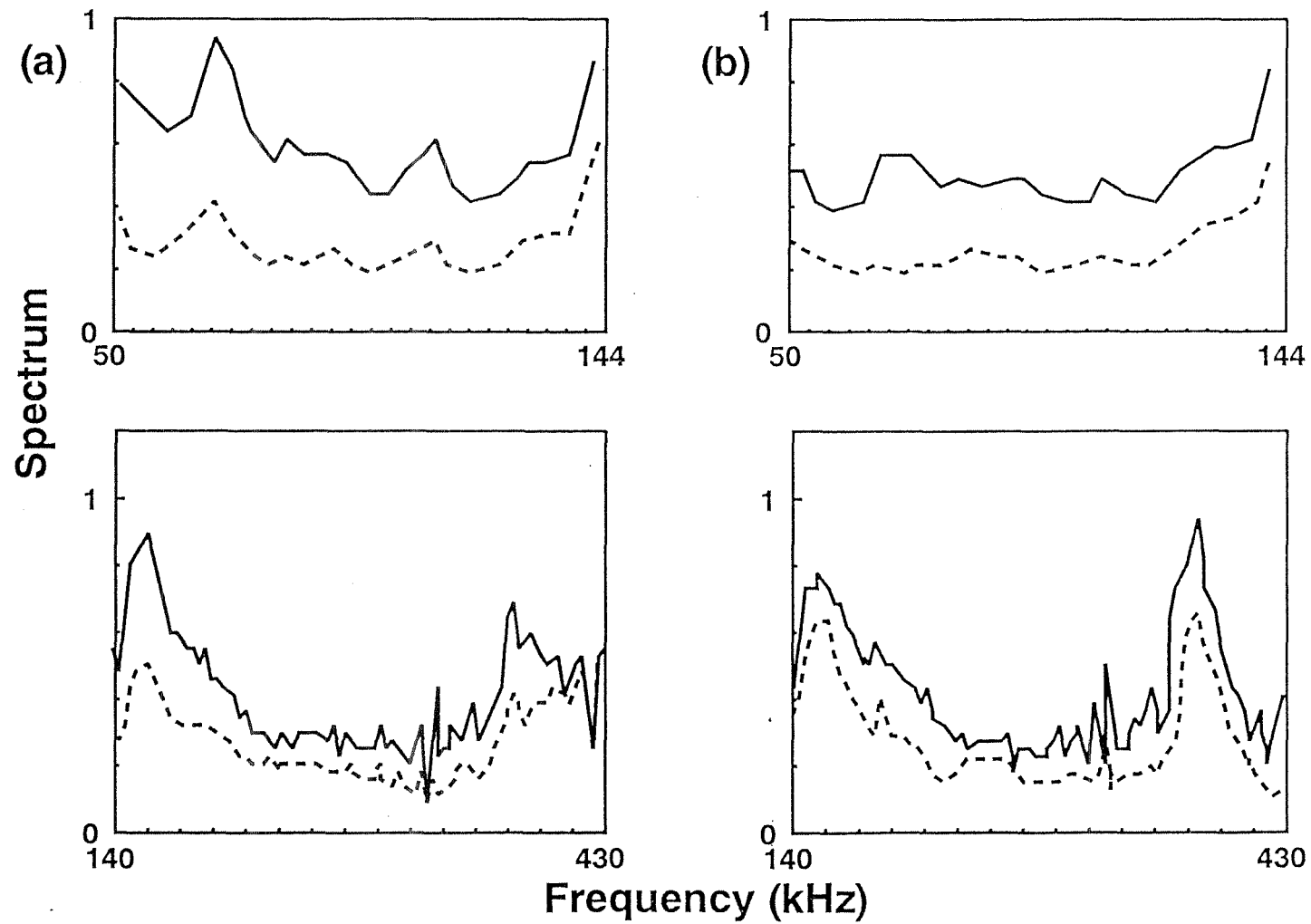

Figure 14

Mean spectra and standard deviation for two species: a) trout, and b) sea perch, using low frequency transducer, 50-144 kHz (upper graph) and high frequency transducer, 140-430 kHz (lower graph) (redrawn from Lebourges, 1990).

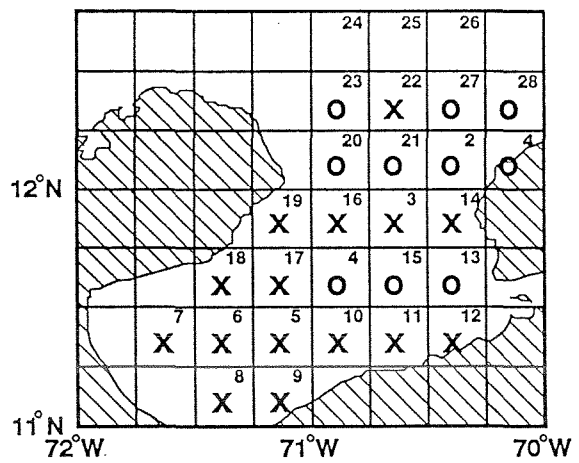
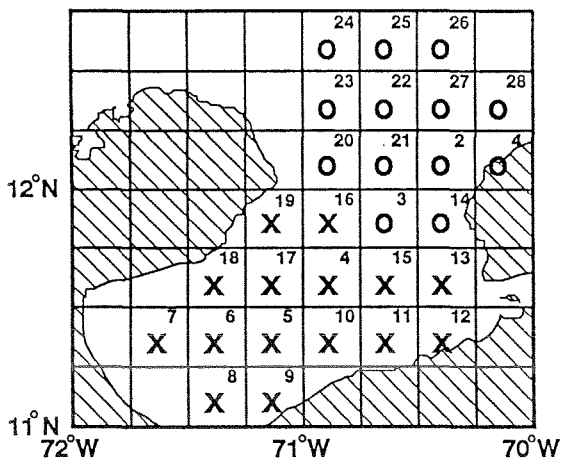
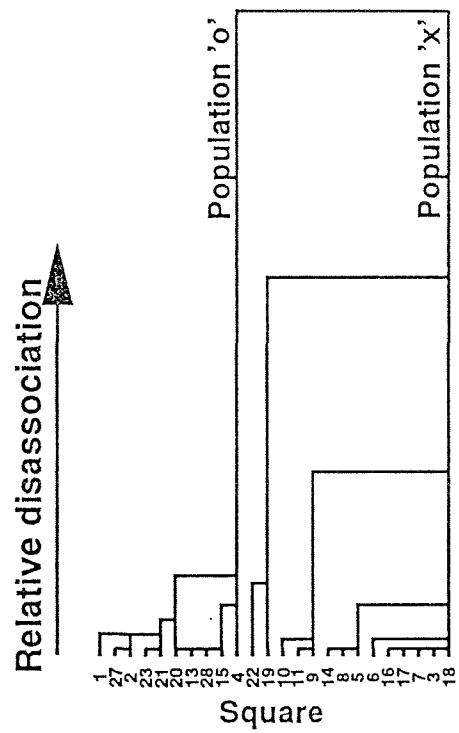
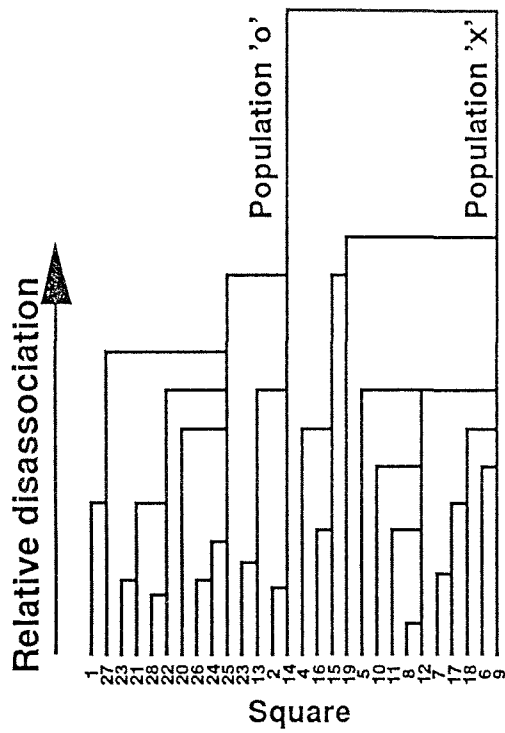

Figure 15

Comparison of: a) natural, and b) acoustic populations in the Gulf of Venezuela: natural population obtained from fishing data. Acoustic populations obtained from echosounder records.

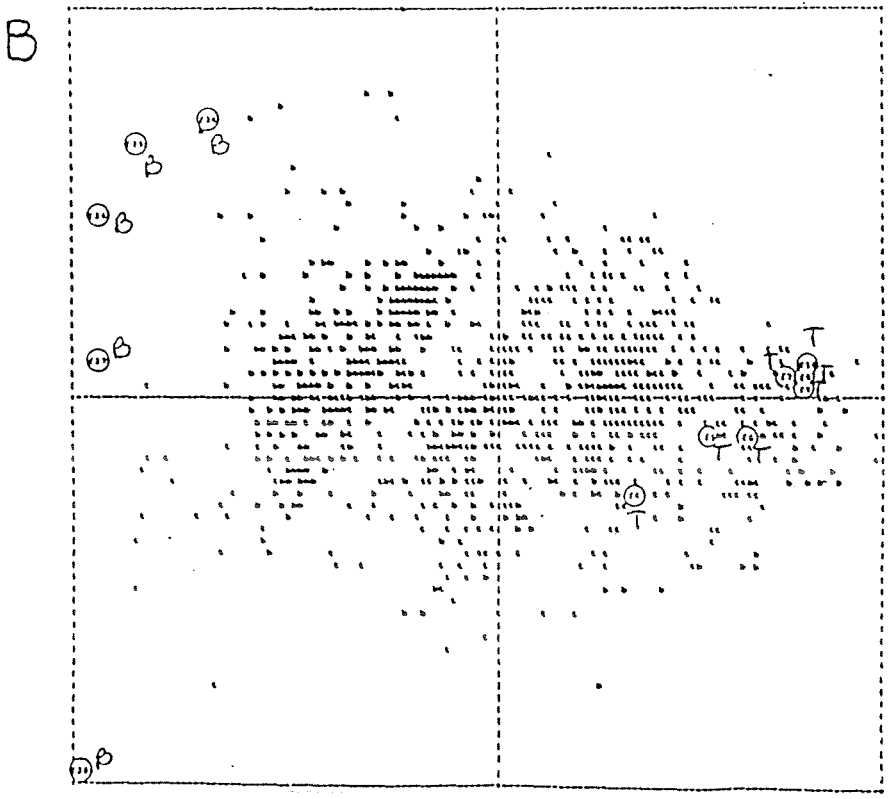
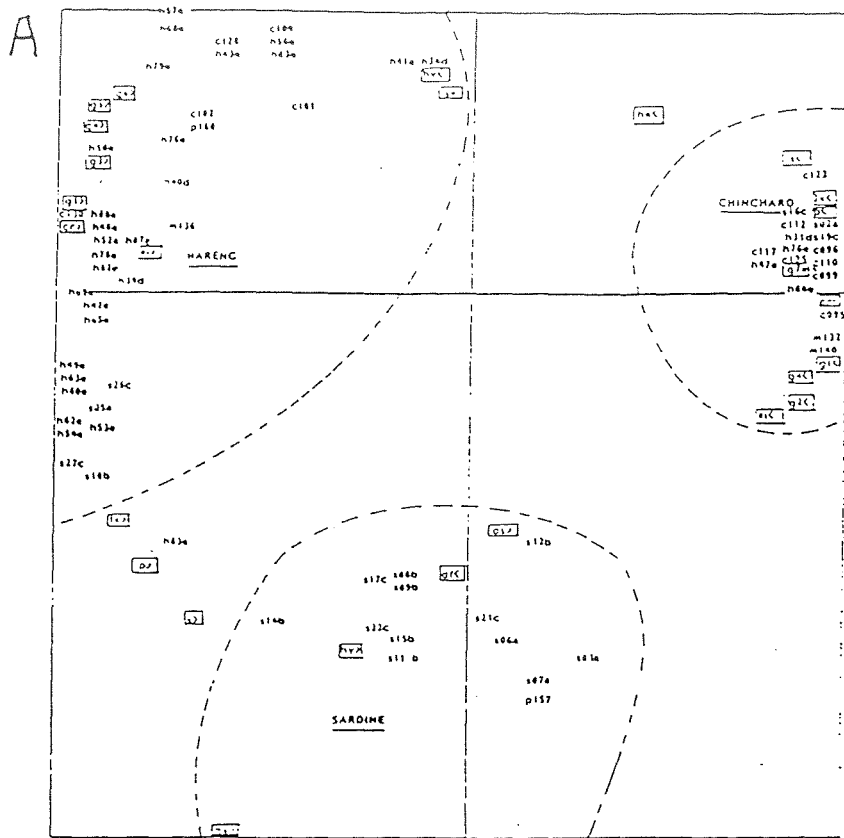

Figure 16

Two examples of the output of multivariate analysis for species discrimination: a) discrimination of schools of herring (hareng), sardine and horse mackerel (chinchard) (redrawn from Souid, 1989); b) discrimination (wide-band) of trout (t) and sea perch (b) (redrawn from Lebourges, 1990).

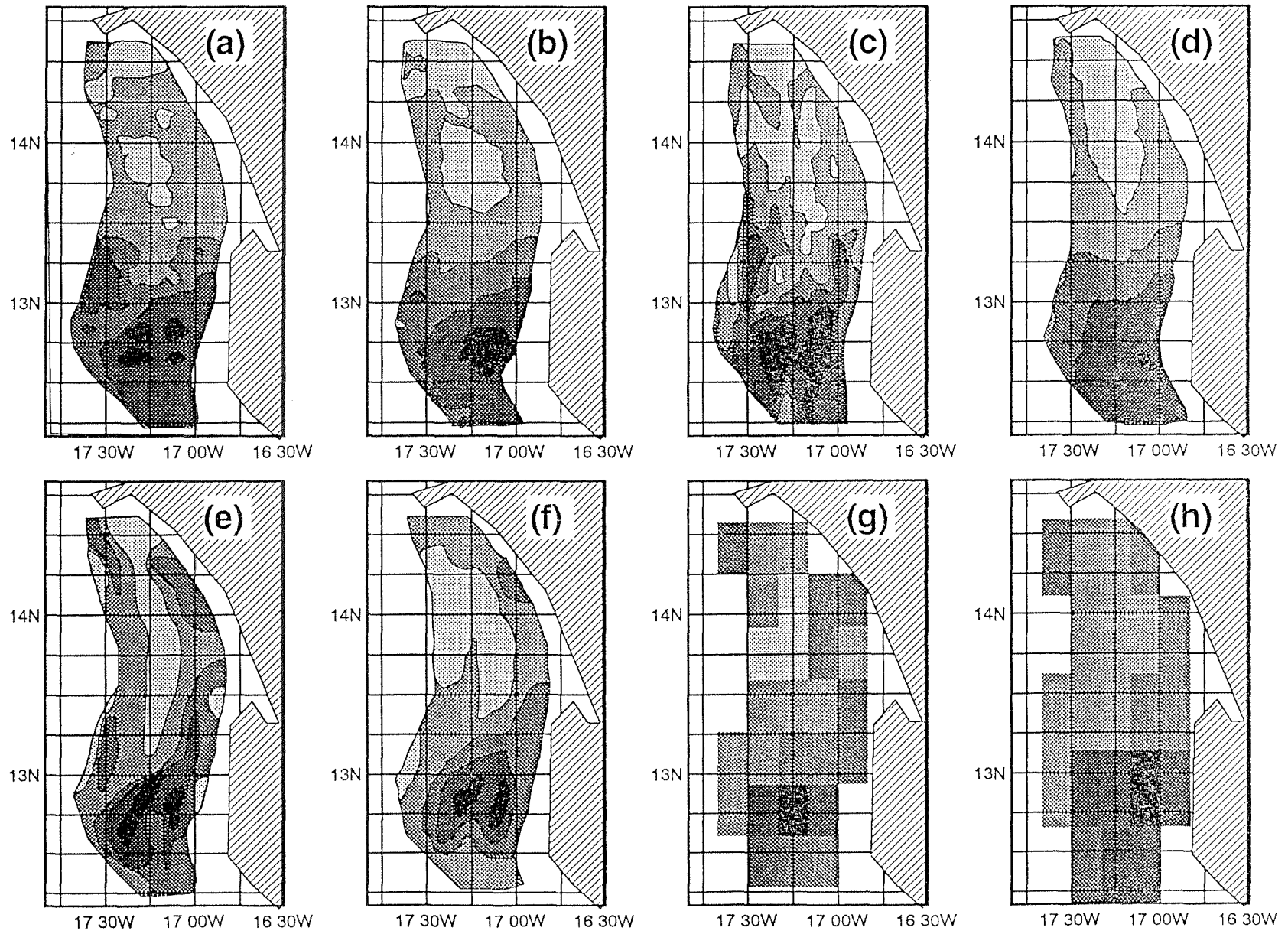

Figure 17

Examples of maps obtained by different spatial averaging methods a-h (see Table 5, p47).

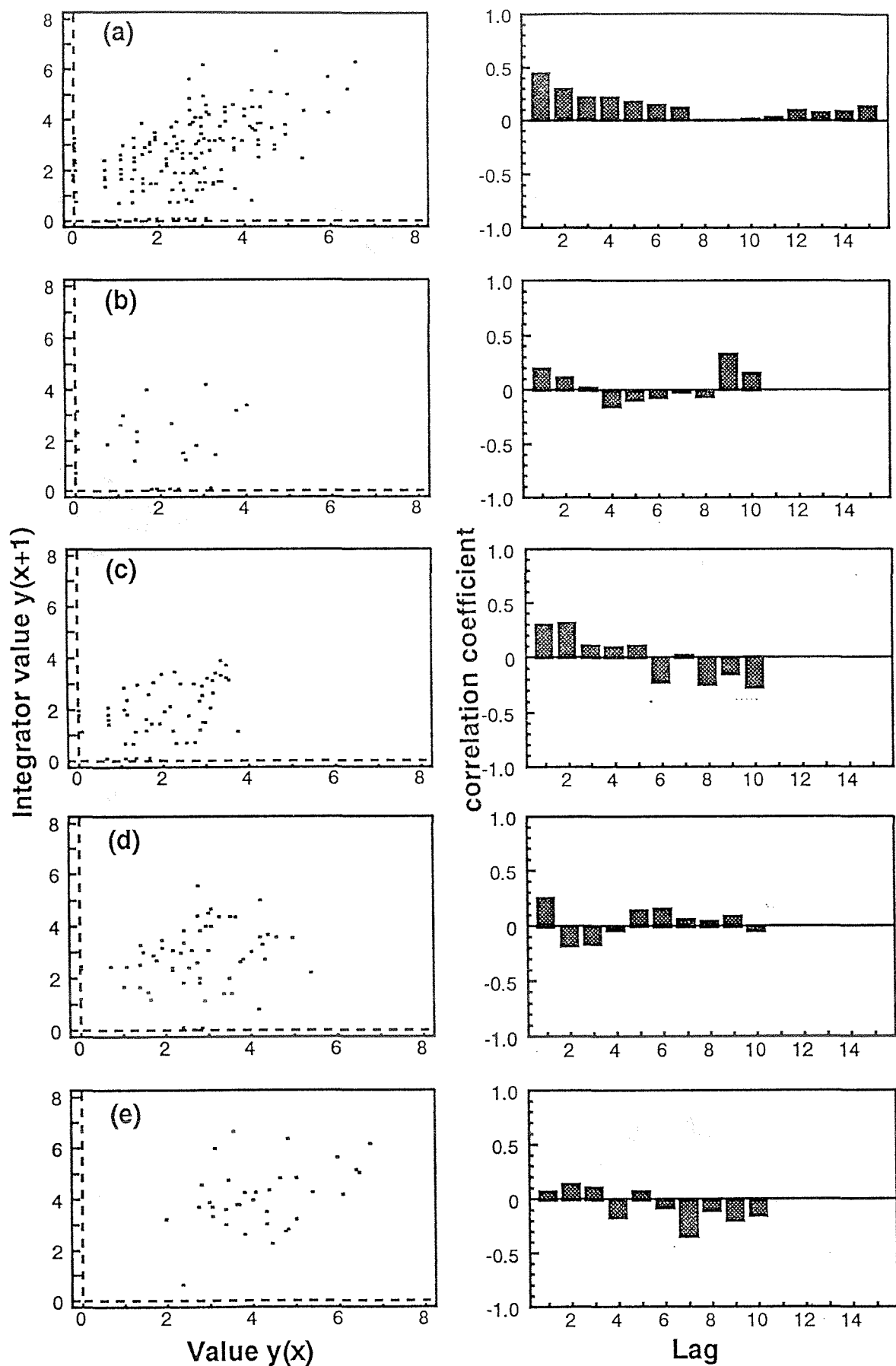

Figure 18 Autocorrelation scatter diagrams x with $x+1$ and correlation coefficients within strata for: a) all strata; b) strata 0; c) strata 1; d) strata 2; and e) strata 3.

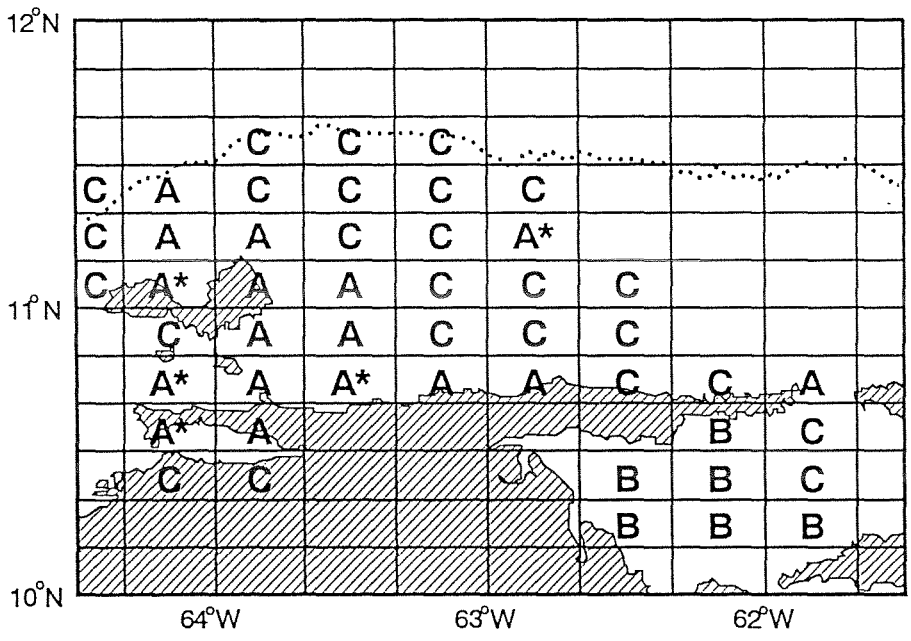
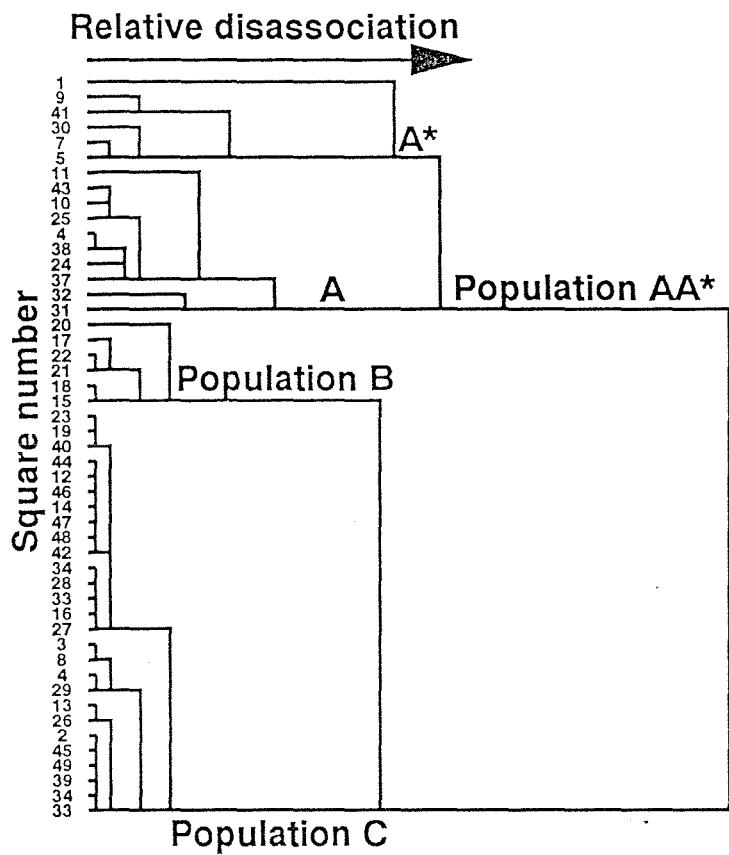

Figure 19 Stratification using acoustic populations (redrawn from Gerlotto and Marchal, 1987).

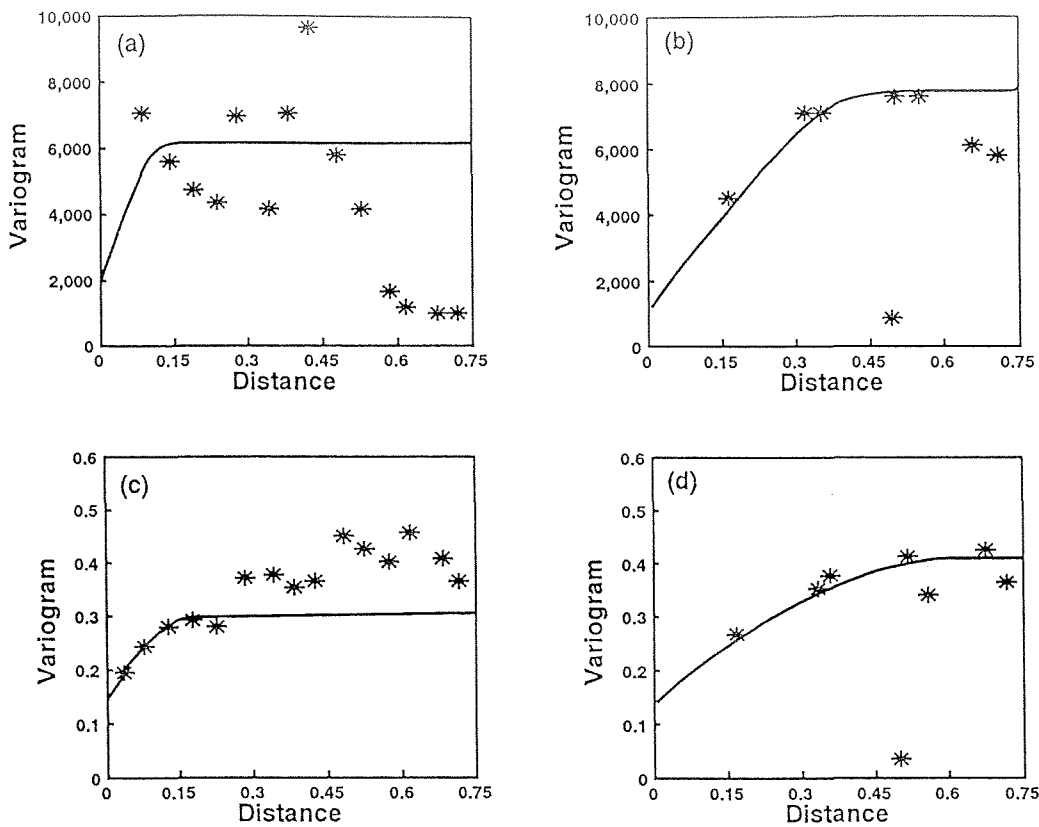

Figure 20 Variograms calculated for the whole area: a) East West arithmetic; b) East West logarithmic; c) North South arithmetic; and d) North South logarithmic.

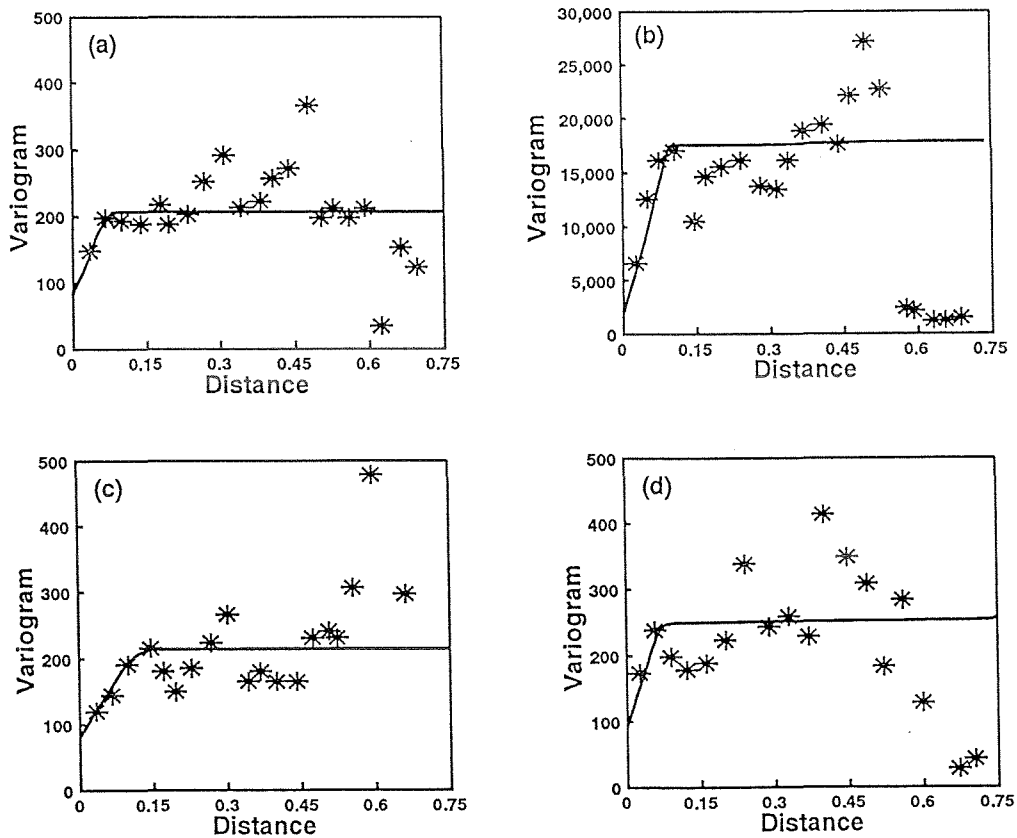

Figure 21 Variograms calculated on parts of the area. a) area north E-W arithmetic; b) area south E-W arithmetic; c) North of area north E-W arithmetic; and d) South of area north arithmetic.

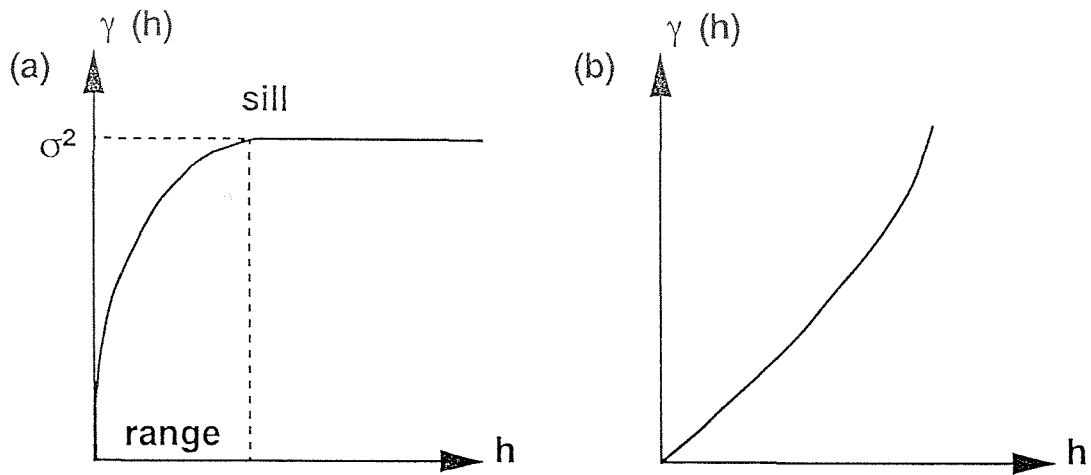

Figure 22 General aspects of variograms: a) bounded, and b) unbounded (redrawn from Armstrong, 1990).

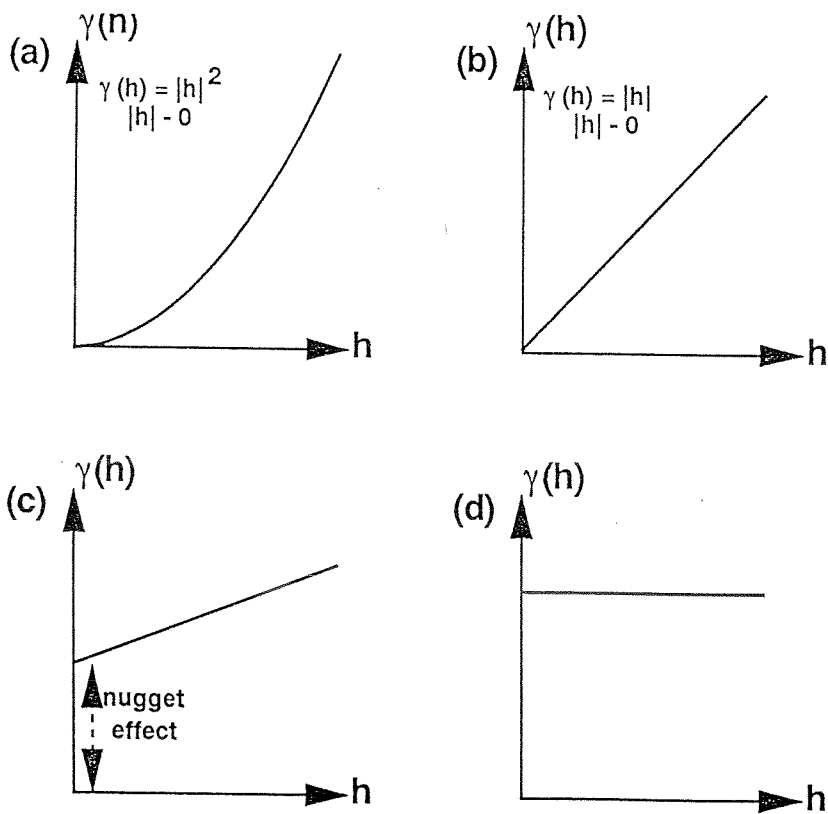

Figure 23 Some types of variograms: a) parabolic; b) linear; c) discontinuity at the origin (nugget effect); and d) no spatial structure (entirely explained by the nugget effect) (redrawn from Armstrong, 1990).

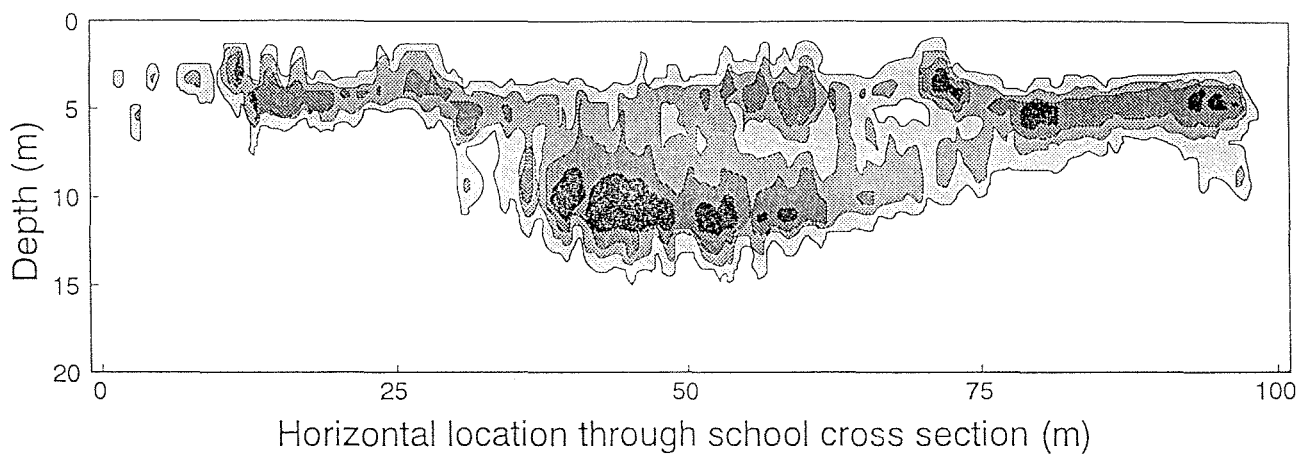

Figure 24 Density profile inside an unperturbed school in Gulf of Cariaco, Venezuela (redrawn from Gerlotto and Freon, 1988).

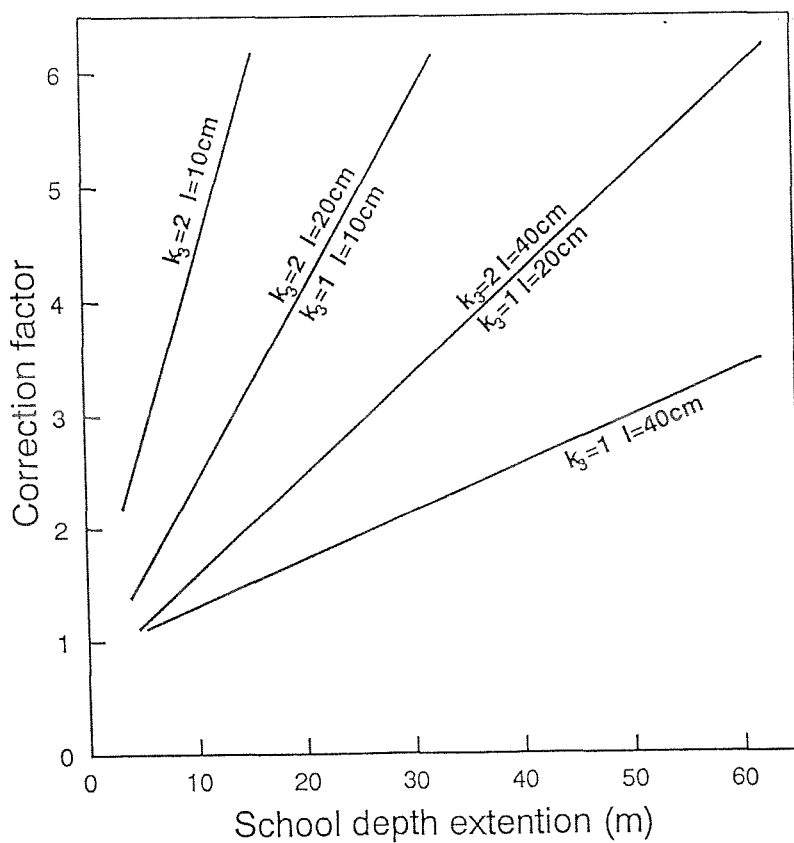

Figure 25 Estimated correction factor of echo abundance of schools of herring versus school depth extension at different fish length ($L = 10, 20$ and 40 cm) and different fish density ($k_3 = 2$ and 4) (redrawn from Olsen, 1987).

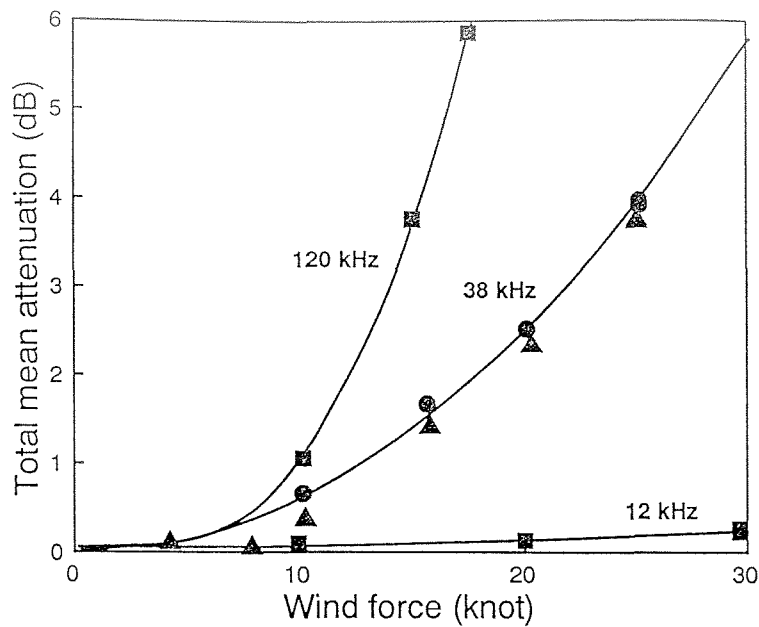

Figure 26

Total mean attenuation from bubbles verses wind velocity at 12, 38 and 120 kHz based on reverberation and bottom integration data (redrawn from Dalen and Lovik, 1981).

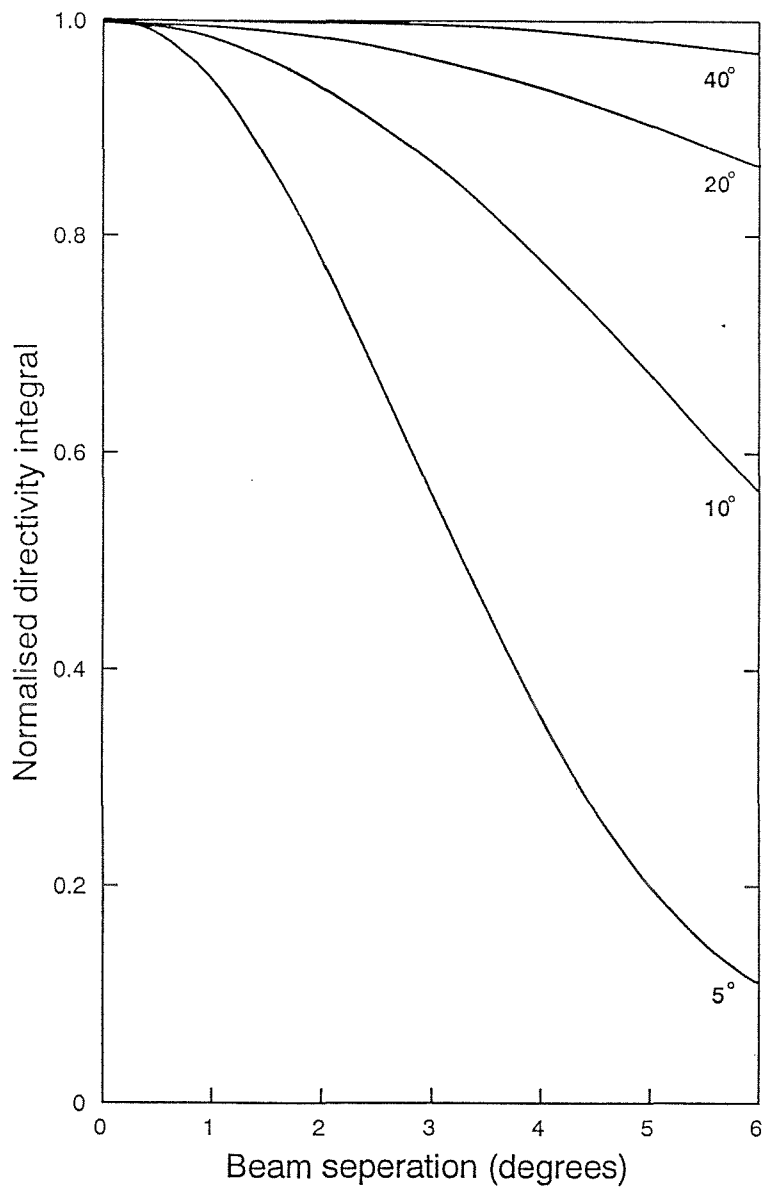

Figure 27

Normalized directivity integral plotted as a function of separation angle of beams. Curves are shown for beamwidths of 5, 10, 20 and 40 degrees (redrawn from Stanton, 1982).

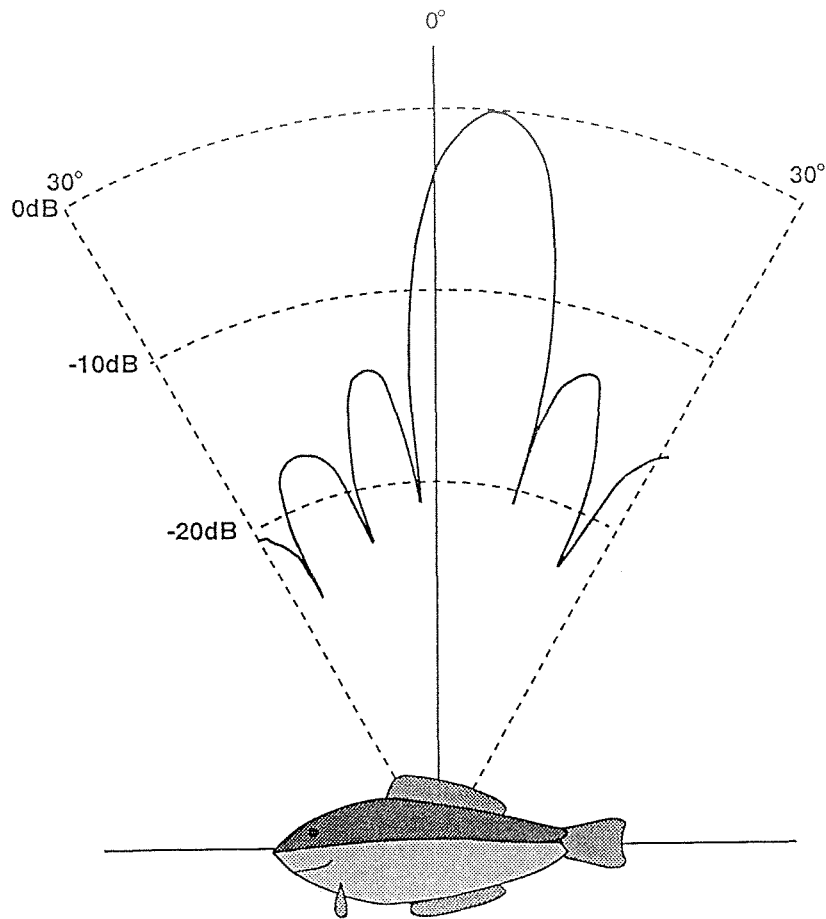

Figure 28 Average directivity pattern of five herring (20-23 cm) at 120 kHz from Olsen (1979).

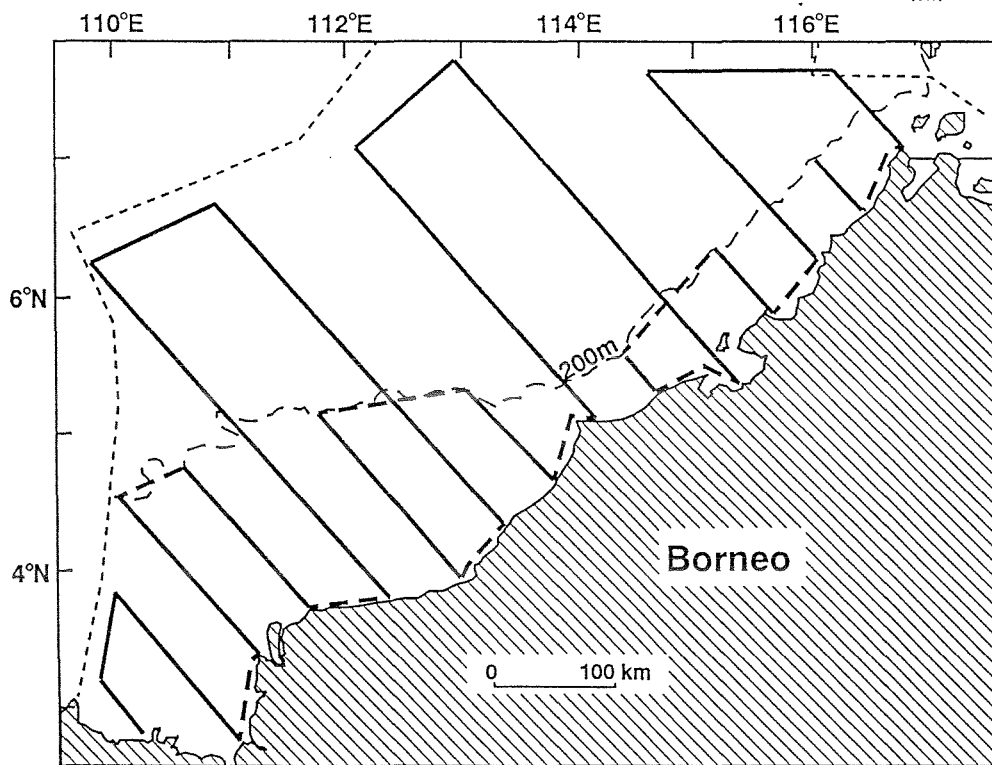

Figure 29 Stratified systematic survey grid for shelf and deep water areas of South China Sea using transect ends on administrative boundaries and omitting transect ends on strata boundaries.

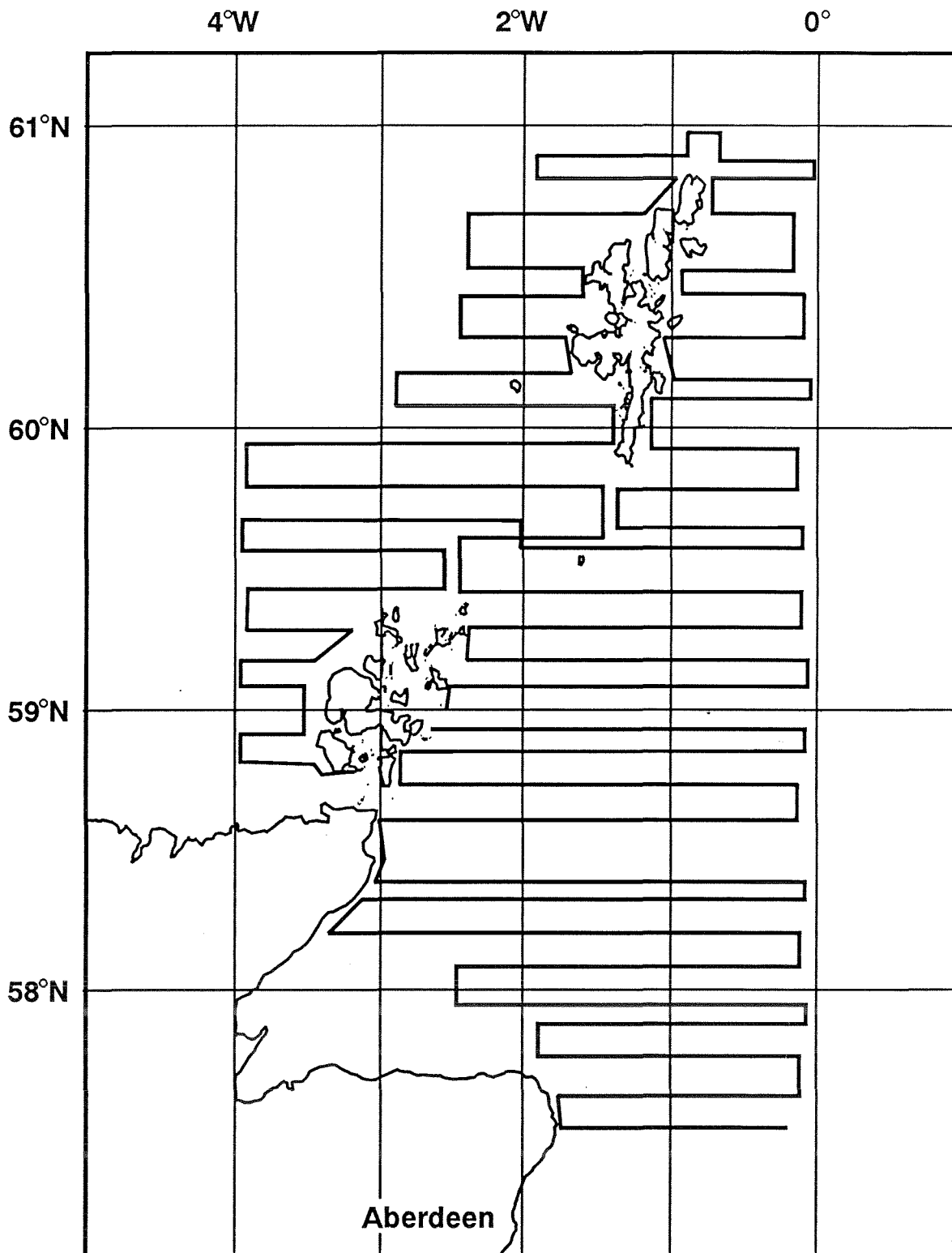

Figure 30

Survey grid for herring showing stratified random design (redrawn from Kirkegaard *et al.*, 1989).

CM 1991/B54

Fischerdirektoratets
Bibliotek